

NI0B-2RNDC

2" Iolite Round Reflector with Round Aperture

Source: 14W to 28W LED
800lm to 2500lm

Type

Project

Catalog No.

Notes

PRODUCT DESCRIPTION

2" Iolite reflectors can be specified for use with Iolite new construction or remodel housings. Deep regressed cone reflectors optimize visual cut-off.

FEATURES

- 800lm, 1000lm, 1500lm, 2000lm or 2500lm LED packages
- 2700K, 3000K, 3500K, 4000K, 5000K @ 90+ CRI
- Comfort Dim (warm dimming) also available in 800lm only
- Flood optic, narrow flood and spot optics (included)
- 5-Year limited warranty

SPECIFICATION

Construction: Reflectors are constructed of heat dissipating, die-cast aluminum. The aluminum die-cast LED heat sink is threaded to fit the reflector and transfer heat.

Mounting: Reflector includes friction blades to mount securely to housing.

OPTICS

800-1000lm: Each reflector includes field changeable optics (23° spot, 28° narrow flood and 29° flood - preinstalled). Premium 15° and 25° TIR optics are also available.

1500-2500lm: Each reflector includes field changeable TIR optics (38° spot, 44° narrow flood - preinstalled and 48° flood).

ELECTRICAL

Lumens / Wattage: 800lm / 14W, 1000lm / 14W, 1500lm / 20W, 2000lm / 24W, 2500lm / 28W

Color Temperature: 2700K, 3000K, 3500K, 4000K, 5000K

CRI: 90+CRI

Operating Temp.: 0°C to 40°C ambient temperature

Lifetime: 50,000 hours @ L70

Comfort Dim: Comfort Dim color tunes the temperature from a bright 3100K, to a romantic and comfortable 2000K on a gradual, even curve. Available in 800lm only.

Dimming: Specified by housing

COMPATIBLE HOUSINGS

Reflectors are compatible with respective Iolite housings manufactured by Nora Lighting.

CATALOG NO.	DESCRIPTION	LUMENS / WATTAGE
NH0ICD-28	ICAT New Construction	800-1000lm / 14W
NH0ICDCP-28	Chicago Plenum	800-1000lm / 14W
NHR0IC-28	ICAT Remodel	800-1000lm / 14W
NH0ICD-215	ICAT New Construction	1500lm / 20W
NH0ICDCP-215	Chicago Plenum	1500lm / 20W
NH0ICD-220	ICAT New Construction	2000lm / 24W
NH0ICDCP-220	Chicago Plenum	2000lm / 24W
NH0ICD-225	ICAT New Construction	2500lm / 28W
NH0ICDCP-225	Chicago Plenum	2500lm / 28W

Accessories: Reflectors will accommodate (1) hex louver and (1) translucent deco collar or opaque snoot, no accessory holder is required, see accessories page. Flush mount mud ring is available to give the appearance of a trimless reflector, compatible with new construction housing only.

LABELS AND LISTINGS

- cULus Listed for Wet Locations
- ENERGY STAR certified
- 5-Year Limited Warranty
- RoHS Compliant
- Certified to the high efficacy requirements of California Title 24 JA8-2019



PRODUCT IMAGES & DIMENSIONS

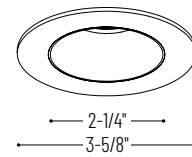

NI0B-2RNDC
Round Deep Reflector
Non-Adjustable



BB
Black Reflector
Black Flange



BW
Bronze Reflector
White Flange



BZ
Bronze Reflector
Bronze Flange



CHMPW
Champagne Haze Reflector
Matte Powder White Flange



CMPW
Specular Clear Reflector
Matte Powder White Flange



HW
Haze Reflector
White Flange



HZMPW
Haze Reflector
Matte Powder White Flange



MPW
Matte Powder White Reflector
Matte Powder White Flange



NN
Natural Metal Reflector
Natural Metal Flange



WW
White Reflector
White Flange

2" Iolite Round Reflector with Round Aperture - Dedicated Housing Required

Reflector Type	Color Temp.	Finish	Lumens / Wattage
NI0B-2RNDC = Round Reflector with Round Aperture	50X = 5000K*	BB = Black / Black	(blank) = 800lm / 14W
	CDX = Comfort Dim [†]	BW = Black / White	
	27X = 2700K	BZ = Bronze / Bronze	/I0 = 1000lm / 14W
	30X = 3000K	CHMPW = Champagne / Matte Powder White	/HL = 1500-2500lm
	35X = 3500K	CMPW = Specular Clear / Matte Powder White	(varies by housing)
	40X = 4000K	HW = Haze / White	
	50X = 5000K	HZMPW = Haze / Matte Powder White	
		MPW = Matte Powder White	
		NN = Natural Metal / Natural Metal	
		WW = White / White	

* 5000K LED modules in 800lm are while supplies last

[†] Comfort Dim available in 800lm only and 1" Iolite uses a different dimming curve than 2" & 4" Iolite

Compatible Housings

Housing Type
NH0ICD-28 = ICAT New Construction / 800-1000lm / 14W
NH0ICDCP-28 = Chicago Plenum / 800-1000lm / 14W
NHR0IC-28 = ICAT Remodel / 800-1000lm / 14W
NH0ICD-215 = ICAT New Construction / 1500lm / 20W
NH0ICDCP-215 = Chicago Plenum / 1500lm / 20W
NH0ICD-220 = ICAT New Construction / 2000lm / 24W
NH0ICDCP-220 = Chicago Plenum / 2000lm / 24W
NH0ICD-225 = ICAT New Construction / 2500lm / 28W
NH0ICDCP-225 = Chicago Plenum / 2500lm / 28W

Example: **NI0B-2RNDC50XWW** = 2" Iolite Round Reflector with Round Aperture, 5000K, White finish, 800lm / 14W

2" Iolite Accessories

2" Iolite Round Reflector with Round Aperture

Type
Project
Catalog No.
Notes

FIELD CHANGEABLE OPTICS

Iolite reflectors include spot, narrow flood and flood optics. Optics can be changed in the field by removing LED module from die-cast reflector. Replacement optics include an optional frosted lens.

Note: Frosted filter-optics and Premium TIR optics are not compatible with /HL LED modules.

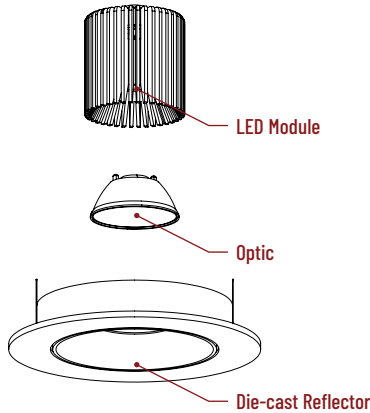

Frosted Filter-Optic

NIO-REFL15FR	15° Optic
NIO-REFL25FR	23° Optic
NIO-REFL38FR	29° Optic
NIO-REFL60FR	29° Optic

Optic assembly includes optional frosted lens. 23°, 29° and 29° optics are included with 800lm and 1000lm reflector.
Not compatible with /HL LED module.



Premium TIR Optics

NIO-REFLTIR15	15° Optic
NIO-REFLTIR25	25° Optic

Not compatible with /HL LED module or Comfort Dim (CDX) technology

ACCESSORIES

Iolite accessories can be added at any point in the design process. Accessories easily install between LED module and die-cast reflector. Luminaire will accommodate (1) hex lower and (1) collar accessory, no accessory holder required.



Translucent Decorative Collar

NIO-AS14(color)	5/8" length
NIO-AS19(color)	3/4" length
NIO-AS26(color)	1" length
Color:	
AM (amber), BLU (blue), FR (frosted), R (red)	

Translucent collars color the aperture with the specified color while producing white general light. Collars are available in different lengths. Use to add interest, create a theme, match a theme or define a space.



Opaque Collar Snoot

NIO-AS14(color)	5/8" length
NIO-AS19(color)	3/4" length
NIO-AS26(color)	1" length
Color:	
BLK (black), MPW (matte powder white), WH (white)	

Opaque snoot greatly reduces aperture brightness while preserving light output. (Note: Black snoot will reduce light)

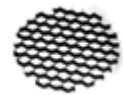

Hex Cell Louver

NIO-HC	Black
--------	-------

Hex cell louver subtly reduces aperture brightness by reducing light output by about 20%.

FLUSH MOUNT

2" Iolite reflectors can be installed flush with the drywall for a flush mount appearance. A flush mount mud ring is installed after the drywall and a professional drywall finisher floats the ceiling to blend in the mud ring.

Flush Mount Mud Ring



NIO-FMMR-2R	Round Mud Ring
-------------	----------------

Mounts trim flush to ceiling with reflector flange visible. **Mud ring attaches to drywall. Requires and only for use with NHIOICD-28 or NHIOICDCP-28 new construction housings and NIOB-2R reflectors.**
Dimensions: 7-7/8" diameter 1/2" thick

PHOTOMETRICS

2" Iolite Round Reflector with Round Aperture
800 lumens

Type

Project

Catalog No.

Notes

Test Information

Test Number: NTR11267
Part Number: NI0B-2RNDC30XWW
Beam Spread: 23° Spot
Lumens: 831lm
Wattage: 14.04W
Efficacy: 59lpw
CCT / CRI: 3000K / 90 CRI
Spacing Criteria (0°-180): 0.38
Spacing Criteria (90°-270): 0.4

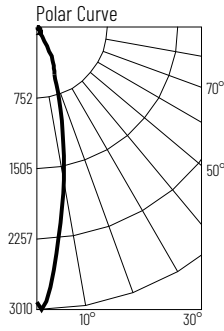

Illuminance at a Distance

Distance from Luminaire	FC at Nadir	Beam Diameter
4'	183fc	1'-7"
6'	81.5fc	2'-5"
8'	45.8fc	3'-2"
10'	29.3fc	4'
12'	20.4fc	4'-10"

Zonal Lumen Summary

Zone	Lumens	% Luminaire
0-30	661	79.6
0-40	712	85.7
0-60	790	95.1
0-90	828	99.6
90-180	3	0.4
0-180	831	100

Candela Table

Vertical Angles	Candela
0	2933
5	2325
15	1007
25	417
35	72
45	57

Test Information

Test Number: NTR11266
Part Number: NI0B-2RNDC30XWW
Beam Spread: 29° Narrow Flood
Lumens: 812lm
Wattage: 14.16W
Efficacy: 57lpw
CCT / CRI: 3000K / 90 CRI
Spacing Criteria (0°-180): 0.48
Spacing Criteria (90°-270): 0.5

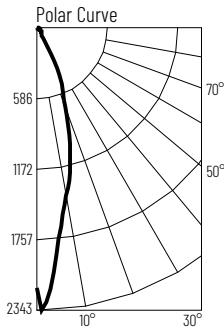

Illuminance at a Distance

Distance from Luminaire	FC at Nadir	Beam Diameter
4'	135fc	2'
6'	60fc	2'-11"
8'	33.7fc	3'-11"
10'	21.6fc	4'-11"
12'	15fc	5'-11"

Zonal Lumen Summary

Zone	Lumens	% Luminaire
0-30	642	79.1
0-40	693	85.4
0-60	772	95.1
0-90	811	99.8
90-180	2	0.2
0-180	812	100

Candela Table

Vertical Angles	Candela
0	2158
5	1690
15	1032
25	448
35	70
45	56

Test Information

Test Number: NTR11268
Part Number: NI0B-2RNDC30XWW
Beam Spread: 28° Flood
Lumens: 834lm
Wattage: 14.23W
Efficacy: 59lpw
CCT / CRI: 3000K / 90 CRI
Spacing Criteria (0°-180): 0.44
Spacing Criteria (90°-270): 0.44

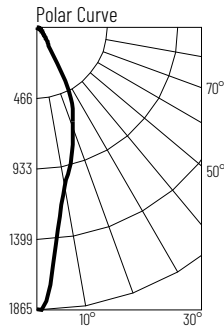

Illuminance at a Distance

Distance from Luminaire	FC at Nadir	Beam Diameter
4'	116fc	2'
6'	51.7fc	2'-11"
8'	29.1fc	3'-11"
10'	18.6fc	4'-11"
12'	12.9fc	5'-11"

Zonal Lumen Summary

Zone	Lumens	% Luminaire
0-30	608	72.9
0-40	698	83.7
0-60	789	94.6
0-90	832	99.8
90-180	2	0.2
0-180	834	100

Candela Table

Vertical Angles	Candela
0	1860
5	1441
15	888
25	549
35	133
45	66

Lumen Output Multipliers

Color Temperature: 2700K (0.97), 3000K (1.00), 3500K (1.04), 4000K (1.16), 5000K (1.17)

PHOTOMETRICS

2" Iolite Round Reflector with Round Aperture 1000 lumens

Type

Project

Catalog No.

Notes

Test Information

Test Number: NTR11271
 Part Number: NI0B-2RNDC30XWW/10
 Beam Spread: 23° Spot
 Lumens: 1090lm
 Wattage: 13.1W
 Efficacy: 83lpw
 CCT / CRI: 3000K / 90 CRI
 Spacing Criteria (0°-180): 0.4
 Spacing Criteria (90°-270): 0.4

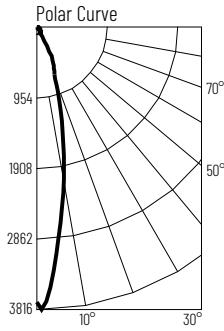

Illuminance at a Distance

Distance from Luminaire	FC at Nadir	Beam Diameter
4'	237fc	1'-7"
6'	105fc	2'-6"
8'	59.2fc	3'-4"
10'	37.9fc	4'-1"
12'	26.3fc	4'-11"

Zonal Lumen Summary

Zone	Lumens	% Luminaire
0-30	869	79.7
0-40	935	85.8
0-60	1037	95.1
0-90	1086	99.6
90-180	4	0.4
0-180	1090	100

Candela Table

Vertical Angles	Candela
0	3788
5	3107
15	1341
25	547
35	95
45	74

Test Information

Test Number: NTR11270
 Part Number: NI0B-2RNDC30XWW/10
 Beam Spread: 29° Narrow Flood
 Lumens: 1058lm
 Wattage: 13.1W
 Efficacy: 81lpw
 CCT / CRI: 3000K / 90 CRI
 Spacing Criteria (0°-180): 0.48
 Spacing Criteria (90°-270): 0.5

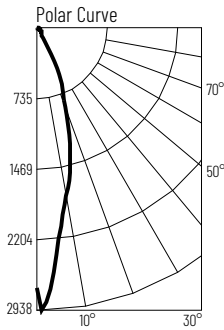

Illuminance at a Distance

Distance from Luminaire	FC at Nadir	Beam Diameter
4'	174fc	2'
6'	77.3fc	3'
8'	43.5fc	4'-1"
10'	27.8fc	5'-1"
12'	19.3fc	6'-1"

Zonal Lumen Summary

Zone	Lumens	% Luminaire
0-30	833	78.8
0-40	900	85.1
0-60	1003	94.8
0-90	1054	99.7
90-180	4	0.3
0-180	1058	100

Candela Table

Vertical Angles	Candela
0	2782
5	2171
15	1340
25	591
35	92
45	74

Test Information

Test Number: NTR11269
 Part Number: NI0B-2RNDC30XWW/10
 Beam Spread: 29° Flood
 Lumens: 1070lm
 Wattage: 13.1W
 Efficacy: 82lpw
 CCT / CRI: 3000K / 90 CRI
 Spacing Criteria (0°-180): 0.44
 Spacing Criteria (90°-270): 0.46

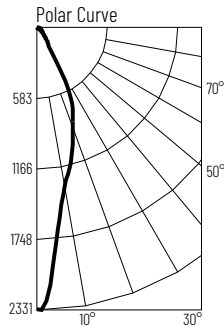

Illuminance at a Distance

Distance from Luminaire	FC at Nadir	Beam Diameter
4'	146fc	2'
6'	64.8fc	3'
8'	36.4fc	4'-1"
10'	23.3fc	5'-1"
12'	16.2fc	6'-1"

Zonal Lumen Summary

Zone	Lumens	% Luminaire
0-30	777	72.6
0-40	895	83.6
0-60	1012	94.6
0-90	1068	99.8
90-180	2	0.2
0-180	1070	100

Candela Table

Vertical Angles	Candela
0	2331
5	1821
15	1131
25	706
35	175
45	85

Lumen Output Multipliers

Color Temperature: 2700K (0.98), 3000K (1.00), 3500K (1.09), 4000K (1.19), 5000K (1.16)

PHOTOMETRICS

2" Iolite Round Reflector with Round Aperture 1500 lumens

Type

Project

Catalog No.

Notes

Test Information

Test Number: NTR1422
 Part Number: NI0B-2RNDC30XWW/HL
 Beam Spread: 38° Spot
 Lumens: 1667lm
 Wattage: 19.8W
 Efficacy: 84lpw
 CCT / CRI: 3000K / 90 CRI
 Spacing Criteria (0°-180): 0.64
 Spacing Criteria (90°-270): 0.64

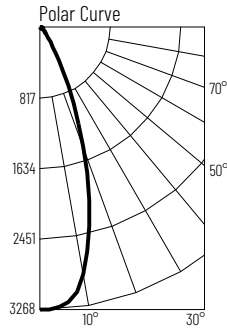

Illuminance at a Distance

Distance from Luminaire	FC at Nadir	Beam Diameter
6'	90.8fc	4'-1"
8'	51.1fc	5'-6"
10'	32.7fc	6'-11"
12'	22.7fc	8'-4"
14'	16.7fc	9'-7"

Zonal Lumen Summary

Zone	Lumens	% Luminaire
0-30	1315	78.9
0-40	1473	88.4
0-60	1600	96
0-90	1662	99.7
90-180	5	0.3
0-180	1667	100

Candela Table

Vertical Angles	Candela
0	3267
5	3216
15	2243
25	862
35	246
45	90

Test Information

Test Number: NTR1425
 Part Number: NI0B-2RNDC30XWW/HL
 Beam Spread: 48° Narrow Flood
 Lumens: 1843lm
 Wattage: 19.86W
 Efficacy: 93lpw
 CCT / CRI: 3000K / 90 CRI
 Spacing Criteria (0°-180): 0.78
 Spacing Criteria (90°-270): 0.8

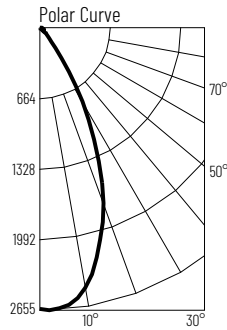

Illuminance at a Distance

Distance from Luminaire	FC at Nadir	Beam Diameter
6'	73.4fc	5'-5"
8'	41.3fc	7'-1"
10'	26.4fc	8'-11"
12'	18.3fc	10'-8"
14'	13.5fc	12'-6"

Zonal Lumen Summary

Zone	Lumens	% Luminaire
0-30	1401	76
0-40	1663	90.2
0-60	1783	96.8
0-90	1838	99.7
90-180	5	0.3
0-180	1843	100

Candela Table

Vertical Angles	Candela
0	2642
5	2600
15	2101
25	1236
35	401
45	93

Test Information

Test Number: NTR1428
 Part Number: NI0B-2RNDC30XWW/HL
 Beam Spread: 44° Flood
 Lumens: 1416lm
 Wattage: 19.65W
 Efficacy: 72lpw
 CCT / CRI: 3000K / 90 CRI
 Spacing Criteria (0°-180): 0.66
 Spacing Criteria (90°-270): 0.66

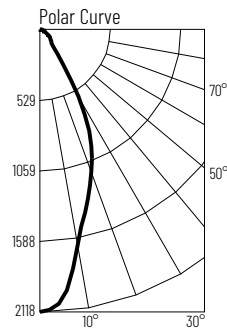

Illuminance at a Distance

Distance from Luminaire	FC at Nadir	Beam Diameter
6'	58.8fc	4'-10"
8'	33.1fc	6'-5"
10'	21.2fc	8'
12'	14.7fc	9'-7"
14'	10.8fc	11'-2"

Zonal Lumen Summary

Zone	Lumens	% Luminaire
0-30	971	68.6
0-40	1159	81.9
0-60	1329	93.8
0-90	1413	99.8
90-180	3	0.2
0-180	1416	100

Candela Table

Vertical Angles	Candela
0	2118
5	2012
15	1366
25	901
35	273
45	122

Lumen Output Multipliers

Color Temperature: 2700K (0.92), 3000K (1.00), 3500K (1.1), 4000K (1.12), 5000K (1.18)

PHOTOMETRICS

2" Iolite Round Reflector with Round Aperture 2000 lumens

Type

Project

Catalog No.

Notes

Test Information

Test Number: NTR1423
 Part Number: NI0B-2RNDC30XWW/HL
 Beam Spread: 38° Spot
 Lumens: 1892lm
 Wattage: 23.54W
 Efficacy: 80lpw
 CCT / CRI: 3000K / 90 CRI
 Spacing Criteria (0°-180): 0.64
 Spacing Criteria (90°-270): 0.64

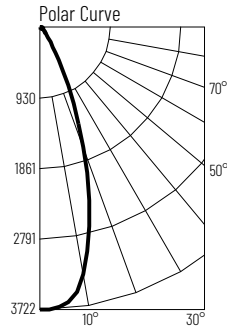

Illuminance at a Distance

Distance from Luminaire	FC at Nadir	Beam Diameter
8'	58.1fc	5'-6"
10'	37.2fc	6'-11"
12'	25.8fc	8'-4"
14'	19fc	9'-8"
16'	14.5fc	11'

Zonal Lumen Summary

Zone	Lumens	% Luminaire
0-30	1495	79
0-40	1663	87.9
0-60	1816	96
0-90	1886	99.7
90-180	6	0.3
0-180	1892	100

Candela Table

Vertical Angles	Candela
0	3718
5	3663
15	2562
25	973
35	276
45	101

Test Information

Test Number: NTR1426
 Part Number: NI0B-2RNDC30XWW/HL
 Beam Spread: 48° Narrow Flood
 Lumens: 2088lm
 Wattage: 23.6W
 Efficacy: 88lpw
 CCT / CRI: 3000K / 90 CRI
 Spacing Criteria (0°-180): 0.78
 Spacing Criteria (90°-270): 0.8

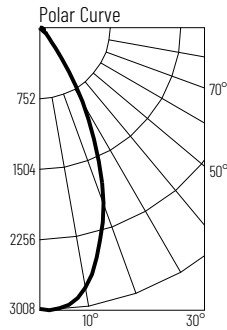

Illuminance at a Distance

Distance from Luminaire	FC at Nadir	Beam Diameter
8'	46.8fc	7'-1"
10'	29.9fc	8'-11"
12'	20.8fc	10'-8"
14'	15.3fc	12'-6"
16'	11.7fc	14'-4"

Zonal Lumen Summary

Zone	Lumens	% Luminaire
0-30	1588	76.1
0-40	1885	90.3
0-60	2020	96.8
0-90	2081	99.7
90-180	6	0.3
0-180	2088	100

Candela Table

Vertical Angles	Candela
0	2993
5	2948
15	2381
25	1402
35	453
45	105

Test Information

Test Number: NTR1429
 Part Number: NI0B-2RNDC30XWW/HL
 Beam Spread: 44° Flood
 Lumens: 1666lm
 Wattage: 23.53W
 Efficacy: 71lpw
 CCT / CRI: 3000K / 90 CRI
 Spacing Criteria (0°-180): 0.66
 Spacing Criteria (90°-270): 0.68

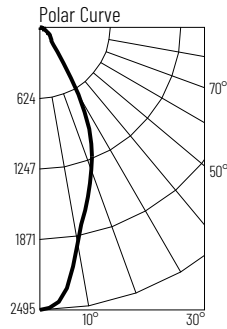

Illuminance at a Distance

Distance from Luminaire	FC at Nadir	Beam Diameter
8'	38.9fc	6'-5"
10'	24.9fc	8'
12'	17.3fc	9'-7"
14'	12.7fc	11'-2"
16'	9.7fc	12'-10"

Zonal Lumen Summary

Zone	Lumens	% Luminaire
0-30	1142	68.5
0-40	1349	81
0-60	1561	93.7
0-90	1661	99.7
90-180	5	0.3
0-180	1666	100

Candela Table

Vertical Angles	Candela
0	2492
5	2372
15	1606
25	1063
35	320
45	144

Lumen Output Multipliers

Color Temperature: 2700K (0.94), 3000K (1.00), 3500K (1.13), 4000K (1.13), 5000K (1.2)

PHOTOMETRICS

2" Iolite Round Reflector with Round Aperture 2500 lumens

Type

Project

Catalog No.

Notes

Test Information

Test Number: NTR1424
 Part Number: NI0B-2RNDC30XWW/HL
 Beam Spread: 38° Spot
 Lumens: 2142lm
 Wattage: 28.47W
 Efficacy: 75lpw
 CCT / CRI: 3000K / 90 CRI
 Spacing Criteria (0°-180): 0.64
 Spacing Criteria (90°-270): 0.64

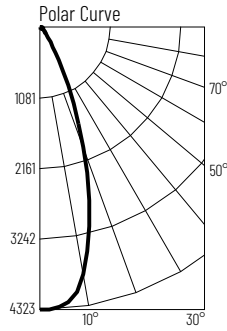

Illuminance at a Distance

Distance from Luminaire	FC at Nadir	Beam Diameter
10'	43.fc	6'-10"
12'	30fc	8'-2"
14'	22fc	8'-4"
16'	16.9fc	10'-11"
18'	13.3fc	12'-4"

Zonal Lumen Summary

Zone	Lumens	% Luminaire
0-30	1703	79.5
0-40	1886	88.1
0-60	2057	96
0-90	2134	99.6
90-180	8	0.4
0-180	2142	100

Candela Table

Vertical Angles	Candela
0	4318
5	4253
15	2944
25	1076
35	299
45	114

Test Information

Test Number: NTR1427
 Part Number: NI0B-2RNDC30XWW/HL
 Beam Spread: 48° Narrow Flood
 Lumens: 2359lm
 Wattage: 28.08W
 Efficacy: 84lpw
 CCT / CRI: 3000K / 90 CRI
 Spacing Criteria (0°-180): 0.78
 Spacing Criteria (90°-270): 0.8

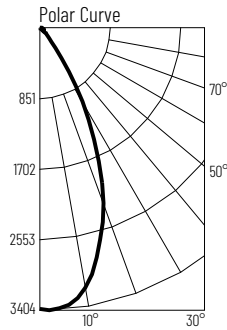

Illuminance at a Distance

Distance from Luminaire	FC at Nadir	Beam Diameter
10'	33.8fc	8'-11"
12'	23.5fc	10'-8"
14'	20.8fc	10'-8"
16'	13.2fc	14'-4"
18'	10.4fc	16'

Zonal Lumen Summary

Zone	Lumens	% Luminaire
0-30	1796	76.1
0-40	2130	90.3
0-60	2283	96.8
0-90	2352	99.7
90-180	7	0.3
0-180	2359	100

Candela Table

Vertical Angles	Candela
0	3385
5	3331
15	2691
25	1583
35	508
45	118

Test Information

Test Number: NTR1430
 Part Number: NI0B-2RNDC30XWW/HL
 Beam Spread: 44° Flood
 Lumens: 1950lm
 Wattage: 28.32W
 Efficacy: 69lpw
 CCT / CRI: 3000K / 90 CRI
 Spacing Criteria (0°-180): 0.66
 Spacing Criteria (90°-270): 0.68

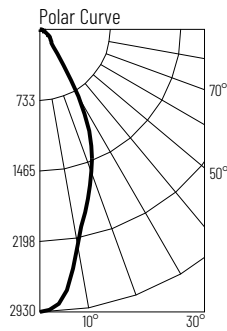

Illuminance at a Distance

Distance from Luminaire	FC at Nadir	Beam Diameter
10'	29.1fc	8'
12'	20.2fc	9'-7"
14'	17.3fc	9'-7"
16'	11.4fc	12'-10"
18'	9fc	14'-5"

Zonal Lumen Summary

Zone	Lumens	% Luminaire
0-30	1336	68.5
0-40	1579	80.9
0-60	1827	93.7
0-90	1945	99.7
90-180	6	0.3
0-180	1950	100

Candela Table

Vertical Angles	Candela
0	2910
5	2763
15	1878
25	1243
35	371
45	168

Lumen Output Multipliers

Color Temperature: 2700K (0.96), 3000K (1.00), 3500K (1.14), 4000K (1.16), 5000K (1.24)