

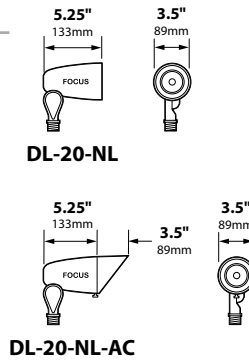

DIRECTIONAL LIGHTS DL-20-NL-SERIES

SPECIFICATIONS

- CONSTRUCTION-DL-20-BRS:** Cast brass Bullet; adjustable cast brass swivel
DL-20: Cast aluminum Bullet; adjustable cast aluminum swivel
CDL-20: Composite Bullet; adjustable composite swivel
- COLLARS-EC:** Cast aluminum extension cap, brass for -BRS fixtures, composite for -CDL fixtures
AC: Cast aluminum angle collar, brass for -BRS fixtures, composite for -CDL fixtures
- O-RING:** Silicone high-temperature red O-ring
- LENS-DL-20-BRS:** Convex high impact clear tempered glass
DL-20, CDL-20: High impact clear tempered glass
- SOCKET:** High temperature ceramic medium base with 250° C silicone lead wires
- WIRING:** Standard 120 volt; black, white and ground, 9" lead wires
- FINISH:** Optional finishes available



**DL-20-NL-EC-BRS
w/FA-26-BRS**



ORDERING INFORMATION

CATALOG NO. DESCRIPTION MAX. WATTAGE LAMP SUPPLIED STANDARD FINISH

PAR20 LAMP FIXTURES-120 VOLT

Outdoor-rated PAR20 lamps (not supplied) must be used with the PAR20 light fixtures listed below.

Model	Description	Max. Wattage	Lamp Supplied	Standard Finish
DL-20-NL	PAR20 aluminum Bullet, no collar	50w	None	Black texture
DL-20-NL-BRS	PAR20 brass Bullet, no collar	50w	None	Unfinished brass
CDL-20-NL-BLT	PAR20 composite Bullet, no collar	50w	None	Black texture
DL-20-NL-EC	PAR20 aluminum Bullet, extension cap, lens	50w	None	Black texture
DL-20-NL-EC-BRS	PAR20 brass Bullet, extension cap, lens	50w	None	Unfinished brass
CDL-20-NL-EC-BLT	PAR20 composite Bullet, extension cap, lens	50w	None	Black texture

DL-20-NL-AC and DL-20-AC-BRS fixtures below supplied without lens; convex and flat lenses are available as accessories.

DL-20-NL-AC	PAR20 aluminum Bullet with angle collar	50w	None	Black texture
DL-20-NL-AC-BRS	PAR20 brass Bullet with angle collar	50w	None	Unfinished brass
CDL-20-NL-AC	PAR20 composite Bullet with angle collar	50w	None	Black texture

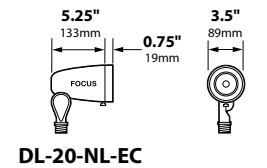

MOUNTING ACCESSORIES

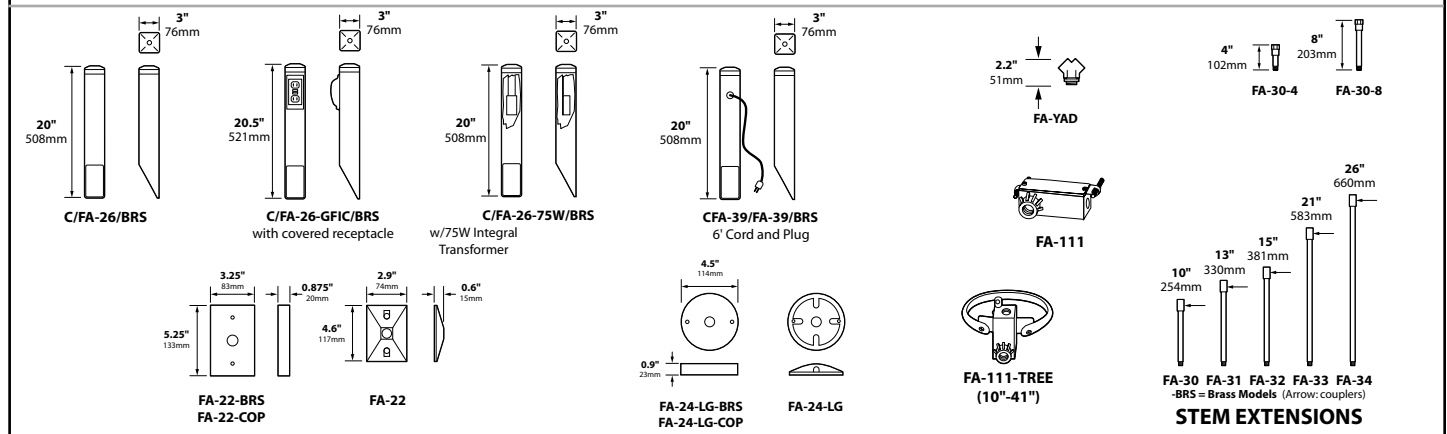

BEAM/GLARE CONTROL ACCESSORIES

FA-08-06	Round 1/4" Hex Cell Louver	2.9" (74mm)
FA-10-20-BLUE	Blue Tempered Glass Lens	2.9" (74mm)
FA-10-20-GREEN	Green Tempered Glass Lens	2.9" (74mm)
FA-38	Aluminum Extension Cap with Tempered Glass Lens	3.5" (89mm)
FA-38-AC	Aluminum Angle Cap with Tempered Glass Lens	3.5" (89mm)
FA-94-[Color]	6" Extra-Long Aluminum Extension Shield with powder coat options	4" (102mm)
FA-98-20	Linear Spread Tempered Glass Lens	3.5" (89mm)
FA-99-20	Convex Tempered Glass Lens	2.5" (64mm)
FA-104-20	Wide Spread Tempered Glass Lens Softener	2.25" (57mm)

JOB INFORMATION

Type: _____ Date: _____

Job Name: _____

Cat. No.: _____

Lamp(s): _____

Specifier: _____

Contractor: _____

Notes: _____

FOCUS INDUSTRIES INC.
 25301 COMMERCENTRE DRIVE
 LAKE FOREST, CA 92630

www.focusindustries.com
 sales@focusindustries.com
 (949) 830-1350 • FAX (949) 830-3390

POWDER COAT FINISHES	Black Texture (Standard)	Antique Verde	Bronze Texture	Camel	White Texture	Hunter Texture	Rust	Weathered Iron	Weathered Brown	Stucco	Rubbed Verde	Chrome Powder	Terra Cotta
Ordering Code	-BLT	-ATV	-BRT	-CAM	-WTX	-HTX	-RST	-WIR	-WBR	-STU	-RBV	-CPR	-TRC



LIGHT DISTRIBUTIONS AND PHOTOMETRICS

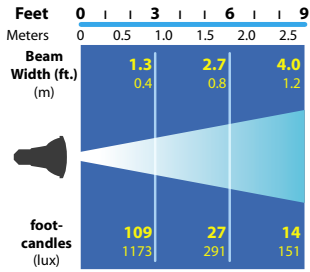

35w PAR20 Flood 30°

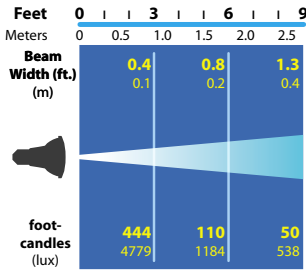

50w PAR20 Spot 10°

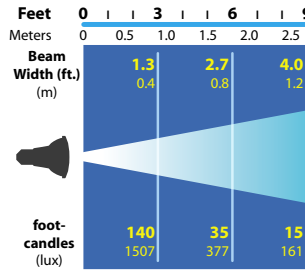

50w PAR20 Narrow Flood 30°

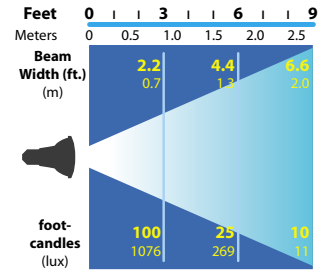

50w PAR20 Flood 40°



INSTALLATION INSTRUCTIONS

DL-20, -30, -38 Series Incandescent Bullet Directional Lights 120v

Inspected by

1. Make sure electrical supply power is shut off at circuit breaker before starting fixture installation or servicing of fixture.
2. Using thread sealant, thread fixture onto junction box or other mounting device (not supplied) until it is at desired direction. Tighten provided lock nut to ensure that the fixture is firmly locked to adjusted position.
3. Attach fixture leads to line in leads observing polarity (black to black, white to white, green to ground) using approved silicone-filled safety wire connectors.
4. Attach junction box cover plate to junction box (not supplied). Make sure wires are not pinched between junction box cover and junction box and gasket seats flush.

5. Coat exposed fixture threads with thread sealant to prevent moisture from entering junction box or other mounting device.
6. To adjust fixture aiming angle, loosen swivel screw. **Do not remove completely.** Hold fixture at selected angle and tighten swivel screw firmly with #2 Phillips screw driver.
7. Install lamp, refer to section below.
8. To install shroud, loosen shroud thumb screw (if present). Turn shroud collar in a circular motion while sliding shroud into housing. **Do not push straight into the housing to prevent O-ring from slipping out of its groove.** Secure shroud to body with thumb screw.
9. Coat all exposed screw with silicone grease.
10. Turn on power to the fixture and check for proper operation.

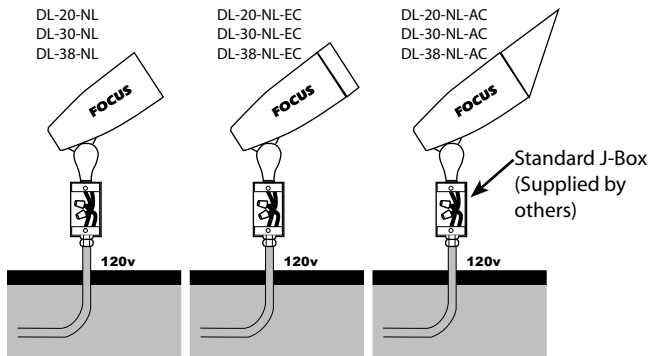

LAMP INSTALLATION/REPLACEMENT:

CAUTION: Do not exceed maximum wattage marked on fixture label.

1. To prevent electrical shock, disconnect fixture from electrical power supply before servicing.
2. Loosen shroud thumb screw (if present).

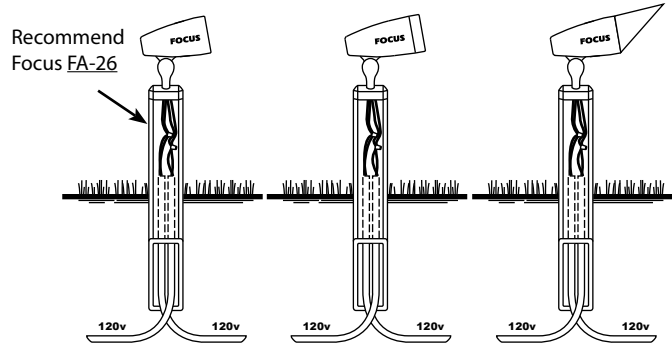

3. Remove shroud to expose lamp.
4. Replace lamp with correct wattage and type marked on fixture label. Use lamp designed for medium base 120v PAR lamps.
5. Re-install shroud. Turn shroud in a circular motion while sliding into housing. **Do not push straight into the housing to prevent O-ring from slipping out of its groove.** Tighten shroud thumb screw.

**NOTE: Must be installed by a licensed electrician per local codes.
For Questions Call 1-888-882-1350**