

# Installation Instructions

## NE-700LEDRC

### Dual Head LED Emergency Light

**READ PRIOR TO ATTEMPTING INSTALLATION**  
**ALWAYS TURN OFF MAIN POWER BEFORE INSTALLATION**  
**INSTALLATION SHOULD BE CARRIED OUT BY YOUR LOCAL ELECTRICIAN**

**⚠ WARNING** - This equipment is intended to be installed only by qualified personnel. The installation must be made in accordance with the current edition to the National Electric Code and all applicable state and local building codes. The final installation must be approved by the appropriate qualified electrical/building inspector(s). Improper installation may result in a fire or electrical hazard. Be sure the electrical power to the circuit has been disconnected before installing this electrical system.

**⚠ AVERTISSEMENT** - Cet équipement est destiné à être installé uniquement par du personnel qualifié. L'installation doit être faite en conformité avec l'édition actuelle du Code national de l'électricité et toutes étatiques et locales codes du bâtiment applicables. L'installation finale doit être approuvée par l'inspecteur en électricité / bâtiment qualifié approprié(s). Une mauvaise installation peut entraîner un incendie ou un risque électrique. Soyez sûr de la puissance électrique vers le circuit a été coupée avant l'installation de ce système électrique.

#### IMPORTANT SAFEGUARDS:

##### READ AND FOLLOW ALL SAFETY INSTRUCTIONS

1. Review the diagrams thoroughly before beginning.
2. All electrical connections must be in accordance with local codes, ordinances and the National Electric code.
3. Disconnect power at fuse or circuit breaker before installing or servicing.
4. Do not use outdoors.
5. Do not mount in hazardous locations, or near gas or electric heaters.
6. Do not let power cords touch hot surface.
7. Equipment should be mounted in locations and at heights where it will not be subjected to tampering by unauthorized personnel.
8. The use of accessory equipment not recommended by the manufacturer may cause an unsafe condition.
9. Do not use this equipment for other than intended use.
10. All servicing should be performed by a qualified personnel only.
11. Allow battery to charge for 24 hours before first use, for 2-battery models, need 48 hours to fully charge batteries.

#### MAINTENANCE:

None required. Replace the batteries as needed according to ambient conditions. However, we recommend that the equipment be tested regularly in accordance with local codes.

#### OPERATION:

Press the test button. The LED heads will turn on and the LED indicator will turn off. Release the test switch and the LED indicator will turn on and the LED heads will turn off.

#### TROUBLESHOOTING GUIDE:

If LED heads or LED indicator does not illuminate, check the following:

1. Check AC supply - verify that unit has 24 hours AC supply.
2. Unit is shorted or battery is not connected.
3. Battery discharge. Permit unit to charge for 24 hours then re-test.
4. If the troubleshooting hints stated above do not solve your problem, contact factory for assistance.

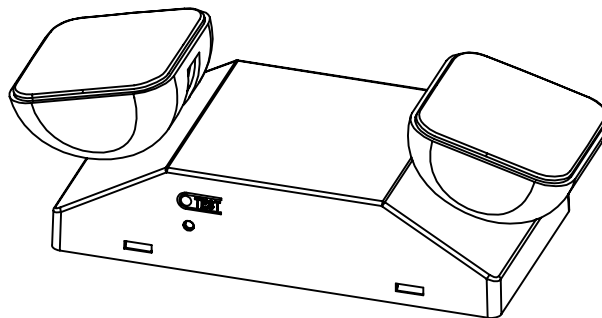

# Installation Instructions

## NE-700LEDRC

### Dual Head LED Emergency Light

**READ PRIOR TO ATTEMPTING INSTALLATION**  
**ALWAYS TURN OFF MAIN POWER BEFORE INSTALLATION**  
**INSTALLATION SHOULD BE CARRIED OUT BY YOUR LOCAL ELECTRICIAN**

#### WALL MOUNT - BACK POWER FEED (FIGURE 2)

1. Use flat blade screwdriver. Insert the screwdriver to the slots and pry off front cover from fixture. (Figure 1)
2. Remove the appropriate knock out from back plate and mount the back plate to the J-Box.
3. Remove the knockout located in the center of the back plate and feed the wires through the hole.
4. Secure the backplate to the J-Box
5. Connect the J-Box wires to the power supply wires using the wire nuts provided. Connect the white wire to neutral. If using 120V, connect the black wire to the hot lead. If using 227V, connect the orange wire to the hot lead. Cap the unused lead and press the wires into the junction box. (Refer to the wiring diagram below)
6. Connect remote heads. Refer to the instruction for remote heads.
7. Connect the male battery connector to female connector on the PCBA. (Figure 2)
8. Snap the front cover onto the back plate.
9. Restore power and press the test button and wait for the LED heads to turn on.
10. Adjust the lamp head and lens direction as needed. (Figure 5)

#### WALL MOUNT - TOP POWER FEED (FIGURE 3)

1. Open front cover and remove top knockout on the top flange of the fixture.
2. Secure conduit (or surface raceway) to knockout and feed wires.
3. Remove keyhole knockout on back plate and mount to wall.
4. Refer to steps 5-10 in Wall Mount - Back Power Feed.

#### CEILING MOUNT - TOP POWER FEED (FIGURE 4)

Refer to the instructions above, Wall Mount - Back Power Feed

Difference between Back power feed and Top power feed:

1. Mount the back plate on the ceiling surface instead of the wall surface.
2. Feed the building AC supply wire through the back plate then connect to the fixture power supply using the wire nuts provided.

#### CONNECTING REMOTE HEADS (OPTIONAL) (FIGURE 5)

1. Connect extended remote head wires using wire nut.
2. Connect the remote head's extended wire to the remote wire.  
 Yellow = Positive (+)  
 Purple = Negative (-)
3. 3.6V 3W max remote capability (for this product)

#### WIRING DIAGRAM:

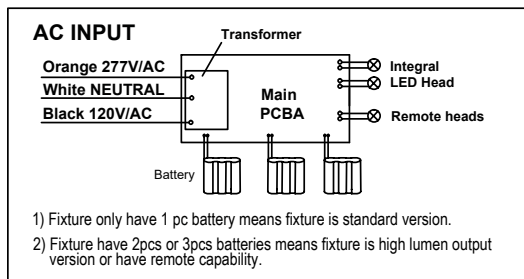

#### Open Fixture

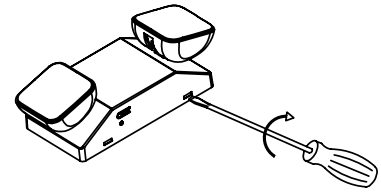

Figure 1

#### Wall mount - Back Power Feed

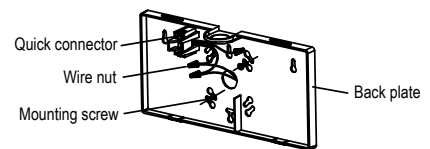

Figure 2

#### Ceiling mount - Top Power Feed

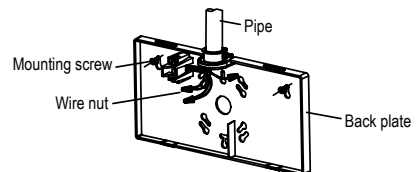

Figure 3

#### Ceiling mount - Top Power Feed

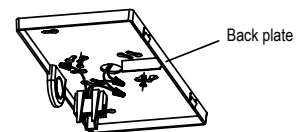

Figure 4

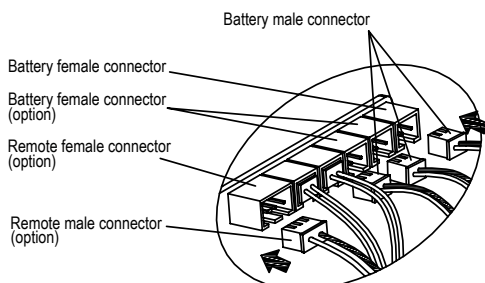

Figure 5

