

1

EKU Porta 60/100 HC

- Door weight up to: 60 or 100 kg (132 or 220 lbs.)
- Maximum door height: 2700 mm (8' 10 5/16")
- Maximum door width: 1600 mm (5' 3")
- Minimum door thickness: 28 mm (1 1/8")
- Height adjustability: +/- 3 mm (1/8")
- For 1 or 2 sliding doors
- Optional soft and self close mechanism

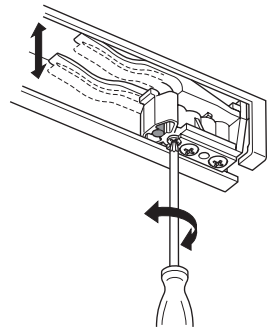
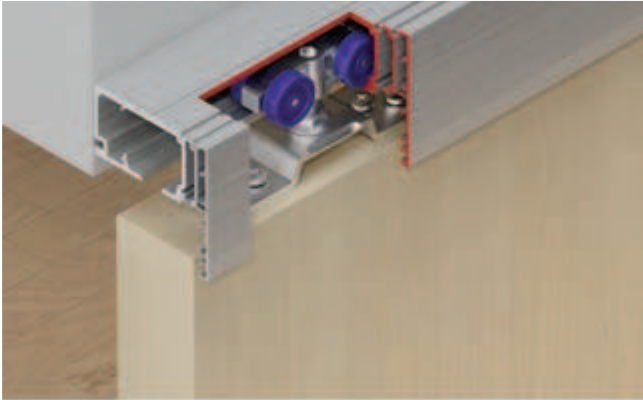

Stopper with adjustable locking force

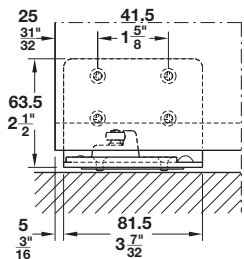

Floor guide with wall mounting bracket

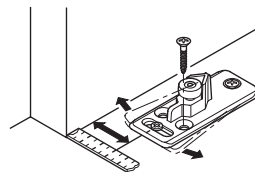

Side adjustable floor guide

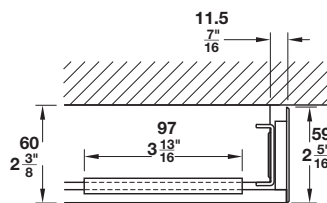

For aluminum panel, aluminum lateral cover

Wall mounted

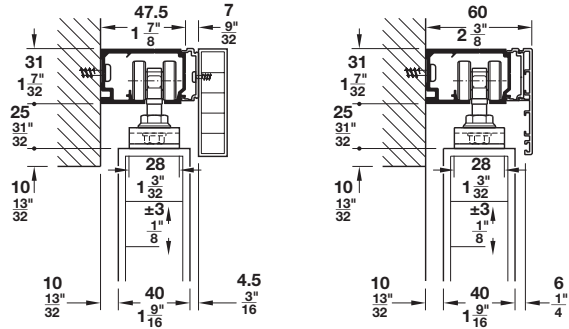

Floor guide

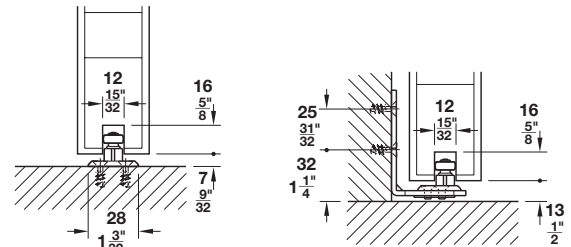

Standard floor guide

Floor guide with wall mounting bracket

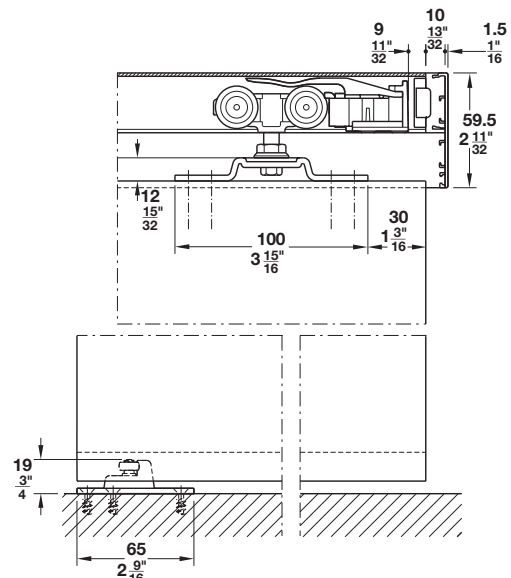

Trolley hanger, track stopper and floor guide

Clip part for cover caps and panels

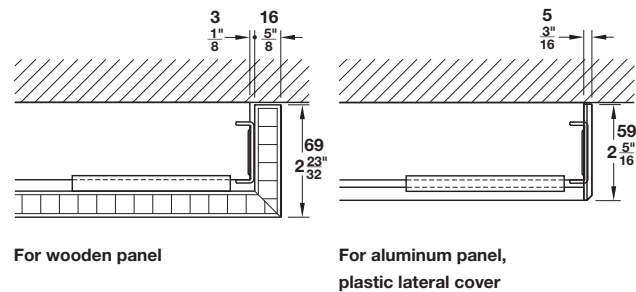

For wooden panel

For aluminum panel, plastic lateral cover

Dimensions in mm
Inches are approximate

Soft and self close

page 1.46

Dimensional data not binding. We reserve the right to alter specifications without notice.

EKU Porta 60/100 HC Set





- For 1 sliding door without the upper track

Door Weight	Item No.
≤60 kg (132 lbs.)	940.60.111
≤100 kg (220 lbs.)	941.00.111





Note

For 2 bi-parting sliding doors, please order 2 sets.

Set Components

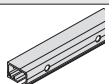
	Description	Material	Finish	Qty.
	Running gear, with four wheels, suspension screw and nut	-	-	2 pcs.
	Support flange	Steel	galvanized	2 pcs.
	Track stopper, with retaining spring	-	-	2 pcs.
	Floor guide, adjustable	Plastic	anthracite	1 pc.
	Fixing screws	-	-	1 set

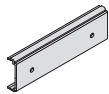
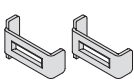
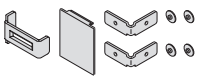
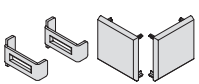
Individual Components

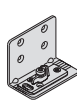
	Description	Material	Finish	Length	Item No.
	Upper track, pre-drilled, 47.5 x 31 mm (1 7/8" x 1 7/32")	Aluminum	anodized	2.5 m (8' 2 7/16")	940.60.825
				3.5 m (11' 5 25/32")	940.60.835
				6 m (19' 8 1/4")	940.60.860
	Clip-on fascia 7 x 60 mm (9/32" x 2 3/8")	Aluminum	anodized	2.5 m (8' 2 7/16")	941.12.425
				3.5 m (11' 5 25/32")	941.12.435
				6 m (19' 8 1/4")	941.12.460
	Clip, for wood and aluminum panel, pre-drilled	Aluminum	mill	97 mm (3 13/16")	940.60.065
	Security bracket set, for wood and aluminum panel, prevents the track from bending apart	Steel	galvanized	-	940.60.093
	End cap, with security bracket for aluminum panel	Aluminum	anodized	-	940.60.066
	End cap, with security bracket for aluminum panel	Plastic	anthracite	-	940.60.067
	Floor guide, adjustable	Plastic	anthracite	65 mm (2 9/16")	941.00.037
	Floor guide, with wall mounting bracket	Steel	galvanized	81.5 mm (3 7/32")	941.00.036

Dimensional data not binding. We reserve the right to alter specifications without notice.

Mortise locks	pages 1.358-1.362
Flush pulls	pages 1.363, 1.371-1.373
Stacking	page 1.48
EKU Porta synchro	pages 1.32-1.33
Soft and self close	page 1.46

Dimensions in mm
Inches are approximate