

1

EKU Porta 60/100 HMD

- Door weight up to: 60 or 100 kg (132 or 220 lbs.)
- Maximum door height: 2700 mm (8' 10 5/16")
- Maximum door width: 1600 mm (5' 3")
- Minimum door thickness: 30 mm (1 3/16")
- Height adjustability: +1/- 3 mm (+ 1/32"/-1/8")
- For 1 or 2 sliding doors
- Optional soft and self close mechanism

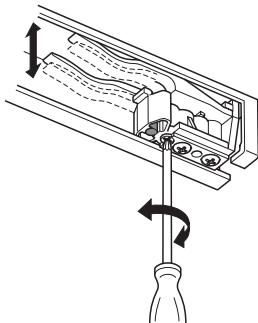

Stopper with adjustable locking force

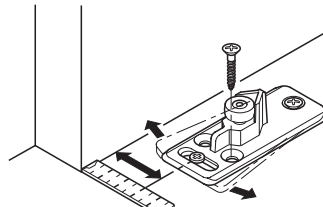

Side adjustable floor guide

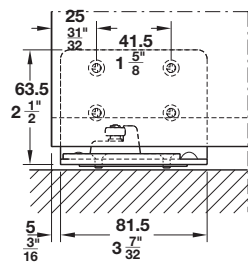

Floor guide with wall mounting bracket

Dimensions in mm
Inches are approximate

Wall mounted

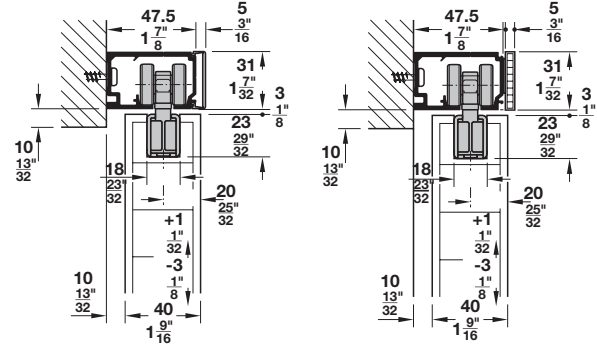

Floor guide

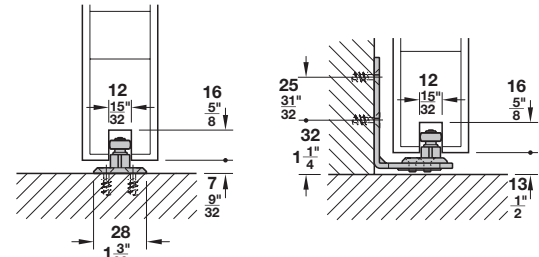

Standard floor guide

Floor guide with wall mounting bracket

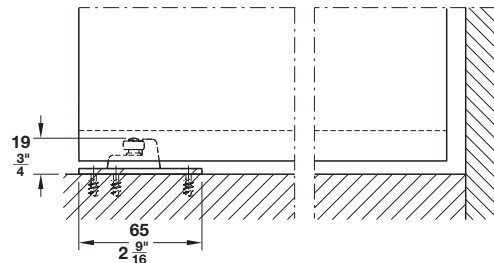
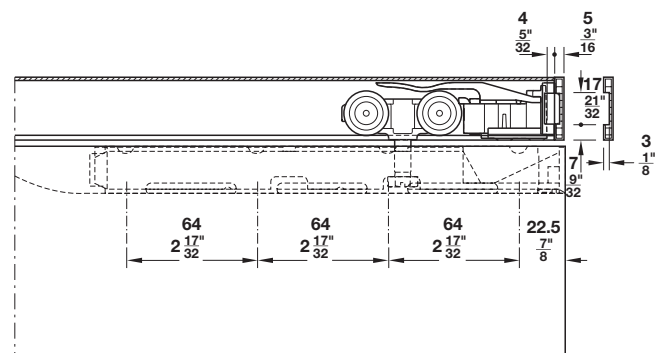

Trolley hanger, track stopper and floor guide
Clip part for cover caps and panels

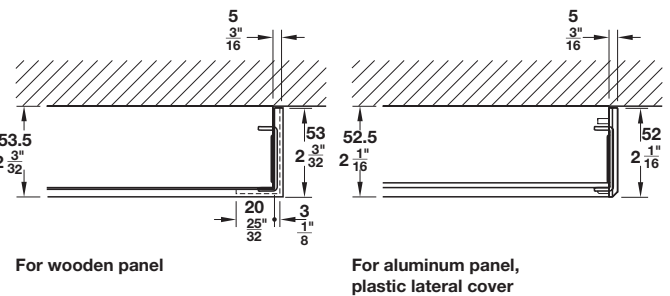

For wooden panel

For aluminum panel,
plastic lateral cover

Soft and self close

page 1.46

Dimensional data not binding. We reserve the right to alter specifications without notice.

EKU Porta 60/100 HMD Set

- For 1 sliding door with the upper track, length 2 m (6' 6 3/4")

Version	Door Weight	Item No.
A	≤60 kg (132 lbs.)	940.60.116







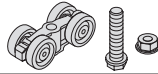

- For 1 sliding door with upper track and clip panel, length 2 m (6' 6 3/4")

Version	Door Weight	Item No.
B	≤100 kg (220 lbs.)	941.00.116

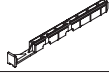

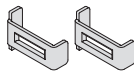
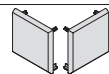

- For 1 sliding door without the upper track

Version	Door Weight	Item No.
C	≤60 kg (132 lbs.)	940.60.115
D	≤100 kg (220 lbs.)	941.00.115

Set Components

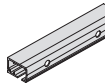
	Description	Material	Finish	Version	Qty.
	Running gear, with four wheels, suspension screw and nut	-	-	A, B, C, D	2 pcs.
	Support profile	Steel	galvanized	A, B, C, D	2 pcs.
	Support profile with end cap	Plastic	anthracite	A, B, C, D	2 pcs.
	Track stopper, with retaining spring	-	-	A, B, C, D	2 pcs.
	Floor guide, adjustable	Plastic	anthracite	A, B, C, D	1 pc.
	Fixing screws	-	-	A, B, C, D	1 set
	Security bracket set, for wood and aluminum panel, prevents the track from bending apart	Steel	galvanized	A, B	1 pc.
	End caps	Plastic	-	B	1 set
	Clip panel	Aluminum	anodized	B	1 pc.
	Track cleaning tool	Aluminum	silver	B	1 pc.

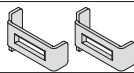
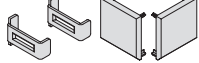
Individual Components

	Description	Material	Finish	Length	Item No.
	Upper track, pre-drilled, 47.5 x 31 mm (1 7/8" x 1 7/32")	Aluminum	anodized	2.5 m (8' 2 7/16")	940.60.825
				3.5 m (11' 5 25/32")	940.60.835
				6 m (19' 8 1/4")	940.60.860
	Clip-on fascia, 31 mm (1 7/32")	Aluminum	anodized	2.5 m (8' 2 7/16")	940.60.725
				3.5 m (11' 5 25/32")	940.60.735
				6 m (19' 8 1/4")	940.60.760
	Security bracket set, for wood and aluminum panel, prevents the track from bending apart	Steel	galvanized	-	940.60.093
	End cap, with security bracket for aluminum panel	Plastic	anthracite	-	940.60.068
	Floor guide, adjustable	Plastic	anthracite	65 mm (2 9/16")	941.00.037
	Floor guide, with wall mounting bracket	Steel	galvanized	81.5 mm (3 7/32")	941.00.036

Dimensional data not binding. We reserve the right to alter specifications without notice.

Dimensions in mm
Inches are approximate