



User Manual



Adash 3750 Monitoring System

Contents

How to Use This Manual	- 4 -
Level 1.....	- 5 -
A3716 and A3750.....	- 6 -
Always Available Counselling for A3750 Directly from Manufacturer	- 7 -
Basic Description	- 8 -
A3716 – Online Measuring System.....	- 8 -
OPC - Data Interface.....	- 9 -
A3750 – Monitoring System	- 9 -
Static and Dynamic Measurements	- 11 -
Control Measurements.....	- 11 -
Normal and Abnormal Machine Operation.....	- 11 -
Grouping of Measurements.....	- 11 -
Measurement Reduction	- 12 -
DDS Database	- 13 -
DDS.....	- 13 -
Level 2.....	- 14 -
List of Terms for A3750.....	- 15 -
Introduction.....	- 15 -
Databases	- 15 -
Online DB - Circular Memory.....	- 15 -
Template DB- Template for DDS Databases	- 15 -
DDS DB	- 16 -
Normal DB	- 16 -
Abnormal DB	- 16 -
Project	- 16 -
Managing projects	- 17 -
A3716 Setup.....	- 17 -
Data Admin Project Editor	- 18 -
TCG Editor	- 18 -
Files.....	- 18 -
dmi File –Project Configuration File.....	- 18 -
ldi File - Configuration File for Data Loader, Loader Ini File.....	- 18 -
adi File - Configuration File for Data Admin, Admin Ini File.....	- 18 -
tcg File - TCG and Reduction Definition File for Data Admin, TCG Ini File.....	- 19 -
A3716	- 20 -
A3716 HW	- 20 -
A3716 SW	- 22 -
Simplified scheme.....	- 22 -
System.....	- 22 -
A3716_MeasEngine	- 23 -
A3716_Server	- 23 -
AOPC_A3716	- 23 -
A3716 Server Monitor.....	- 23 -
A3716 Signal Analyser	- 24 -
A3750 Installation.....	- 25 -
Computer Requirements	- 25 -
Hardware	- 25 -
Software.....	- 25 -
A3750, Including Related Software.....	- 26 -
Working Directory.....	- 26 -
Structure and Placement of Working Directory	- 27 -

Licences	- 27 -
A3750 Project	- 28 -
Information Necessary for Creation of New Project	- 28 -
A3716 Setup.....	- 29 -
Creation of New Project	- 29 -
Procedure to create a new project.....	- 29 -
Parameters and Buttons of Online DB Group	- 30 -
Buttons in DataLoader Group	- 30 -
Buttons in DataAdmin Group	- 31 -
Adding new A3716 into system	- 31 -
Sensors	- 32 -
AC Sensor Properties	- 32 -
DC Sensor Properties.....	- 33 -
Tacho Properties	- 34 -
Creating the measurements list	- 34 -
Data Admin Project Editor	- 36 -
Template DB - DDS Databases Template	- 36 -
Data Admin Project Editor	- 37 -
Creation of New adi Configuration File and Template database	- 37 -
Restructuring of Template DB Database Tree	- 38 -
Maintenance of Existing adi Configuration File	- 44 -
How to Add New Measurements to Project.....	- 44 -
Procedure of Adding New Measurements to adi Configuration File.....	- 44 -
Restructuring of Template DB Database Tree.....	- 45 -
TCG Editor	- 48 -
Starting of TCG Editor Software.....	- 48 -
Creation of First New Reduction	- 49 -
Reduction Intervals	- 50 -
Max. Dilution - Parameter of Data Dilution	- 52 -
Significant Change of Static Data.....	- 53 -
Storing Reduction in tcg File.....	- 54 -
Creation of Another Reduction.....	- 54 -
Change of Reduction Parameters.....	- 56 -
Change of Reduction Name	- 56 -
Creation of First New Normal TCG	- 57 -
Saving of TCG Definition in tcg File.....	- 61 -
Creation of First New Abnormal TCG	- 61 -
Entering of Name and Creation of TCG Frame.....	- 63 -
Abnormal TCG Control Quantity.....	- 64 -
Adding of More TCGs.....	- 67 -
Change of TCG Parameters	- 68 -
Change of TCG Name	- 68 -
Adding, Removing and Suspending Measurements in TCG Lists	- 68 -

How to Use This Manual

A content of this manual is a complete description of the A3750 monitoring system. The manual is divided into two difficulty levels for easier orientation.

Level 1 simply describes basic functions and does not dwell on details that are not important during the first reading. After you read the first level, you will gain necessary basic knowledge of A3750 behaviour, and will be ready to read **Level 2**.

Level 2 contains more detailed information about the A3750. We are focused primarily on information about its settings for practical operation. After you finish the **Level 2**, you will be able to install and set the A3750 on your own in such way that will provide you with required data.

Level 1

A3716 and A3750

A task of A3716 is to measure analogue signals from protection systems or from directly connected sensors.

The protection system usually does not store the measured and consequently analysed values, but overwrites them in the memory by new ones after the analysis. If the user wants to use the measured values for a predictive maintenance control, the additional product must be used, usually called a "Monitoring System". This system continually stores the measured values into a computer, where they are prepared for further processing. We have developed the online monitoring system A3750 with the 16 channel parallel dynamic signal acquisition unit A3716.

What properties do we expect from the continuous storing of the measured data? To start, the user usually answers that he would want to store all the measured data. However, this means that we would need to store very large amount of data approximately every second. If we calculate the volume of this data for just one day, we shall find out, that such database shall have several gigabytes. This is not acceptable even today, when sizes of hard disks are sufficient. This size is not our limiting factor, however. The actual limitation lies in a time demand for processing of such a large database, since the processing of the large database is much slower than of a small one.

Therefore we need to reduce the data and keep the database within reasonable size limits. The word "reduce" means that we do not store all available data. A simple reduction means that the data is stored in larger intervals (for example 15 minutes), and the data in between is removed. In case that the measured values are stable and acceptable, such approach suits to diagnostic requirements. A3750, however, uses more sophisticated data reduction.

However, if the measurements show fast changes, the longer interval is not suitable, and we need to store the data more often. For example, in case of a turbine start up, we would want to store all available data, i.e. the interval would be around one second.

A3750 must be able to accept such contradictory requirements. Its activity takes place on two levels. In the first level it stores the more reduced data, and enables long-time measurements, with acceptable size of the database. If the machine works within acceptable values, the device is active only on the first level, the second level is idle. An activity on the second level wakes up only when one of the measured values is beyond the acceptable limits. Then fast acquisition of data occurs, and the values get stored into a different database, than on the first level. This fast acquisition on the second level lasts until the values return into the acceptable limits. Then the operation of the second level ends. The data collection on the first level keeps running, it is not interrupted by the activities on the second level.

We have explained that the fast collection starts, when some measured value is not acceptable. However, there is a reasonable requirement that we would like to have the fast collected data for the time before the origin of the unacceptable situation. Even this the A3750 can handle thanks to a special circular memory that stores ALL available data. This memory contains the last several hours of the measurements in full definition. The process of data collection then can load even the "fast" data retroactively.

We have described the collection of data on two levels very generally. Now certainly there shall appear questions, like:

- Can every measured quantity start the second level data collection?
- How are the acceptable intervals defined?
- How does the data reduction procedure work?

All characteristics of the data collection and reduction can be set based on real life requirements. We shall explain this in detail in the following text.

If the data are stored in the databases, they are prepared for further evaluation, and they can bring much more information about status of the monitored machinery to the user. This information is not

available, and really it is lost, since the protection system is used only without the tie-in A3750 monitoring system.

So the A3750 can fulfil three, at the first sight contradictory, however, at the same time legitimate, requests of the user:

1. Store suitably reduced measured data without excessive increase of a database volume on the long-time basis.
2. Collect and store measured data as often as to pick up even short-term events that are important for further analysis and drawing of correct measures to protect the diagnosed equipment.
3. In case of extraordinary situation store complete or little reduced data, including the data measured before an occurrence of the extraordinary event.

Work of A3750 is divided into two stages to fulfil these requirements:

1. Storage of complete data collected sufficiently often into the circular memory that contains the measured data for a limited time. The circular memory enables access to the data that were measured before the extraordinary event. The 24 hours history is usual size of circular memory.
2. Storage and reduction of measured data. The measured data are continuously stored at this stage with set reductions. In case of an extraordinary situation complete or little reduced data are being stored. Thanks to the circular memory, it is possible to store even data measured before the occurrence of the extraordinary event.

Always Available Counselling for A3750 Directly from Manufacturer

Reasons, why use the A3750 monitoring system, are clear. You shall have your machine operation under continual supervision, and you can take advantage all available information for diagnostics. If you know actual operational status of all your equipment, you can efficiently plan its maintenance and lower costs. Resources spent to buy the diagnostic system have very high returnability.

The A3750 monitoring system is designed to enable different kinds of user operations. Typical cases, for example, are:

1. The user is fully familiar with A3750 and uses it continuously and independently.
2. A3750 runs without continuous analysis of stored data by the user. In situation, when unacceptable measurement values occur, an external consultant is asked for a report. The user may come in personally and perform the analysis in situ, or user can do it remotely from the office. The user always has all the necessary data available.
3. The user does not have own workers to work with A3750, in spite of this requests regular diagnostic reports and recommendations. Then the A3750 is operated remotely under direct manufacturer's supervision. Nowadays, when Internet is commonly available, A3750 can be remotely supervised anywhere in the world.

Since this is a system that is constantly under improvement, the manufacturer provides regular updates and upgrades that can be downloaded without charge on its web site. We try to react quickly to your suggestions and include the improvements in a new version. Cooperation with final users is without substitution for this product further development.

Basic Description

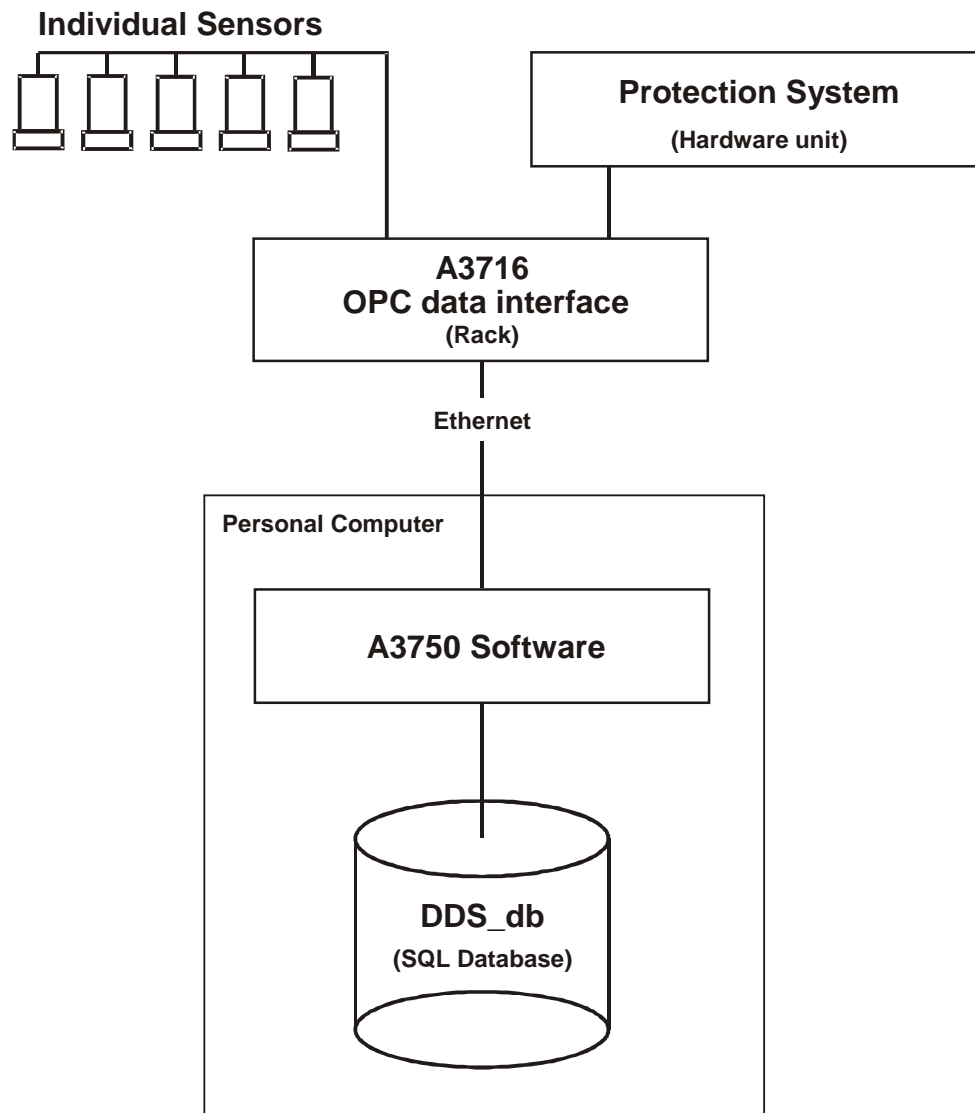

Please note that the following hardware is needed for the A3750 monitoring system:

1. A3716 rack connected to protection system or to sensors,
2. IBM PC type computer to run A3750 software,
3. Ethernet connection between them, i.e. standard LAN.

In addition the A3716 uses an OPC data interface. This is a stand alone software that helps to exchange data between the measurement system A3716 and the monitoring system A3750.

A3716 – Online Measuring System

A detailed description of A3716 measuring system is the subject of a separate manual; we shall not deal with it here.

OPC - Data Interface

This is a standardised data interface, commonly used in machine control. In other words, this is a software that runs on a A3716. The main objective of the OPC is to load measured values from A3716 system and make them accessible for A3750. You can argue, why the two Adash systems do not cooperate directly, but across the intermediary. The reason is simple: Some required processing parameters are not available in A3716 measurement system (e.g. true power, etc.), but they should be monitored through A3750. Such data can be measured by other company systems, and simply transferred to the OPC interface, since it is already normalised. A3750 monitoring system then loads all the necessary data from various sources in the same standard format.

We can imagine the OPC data interface as a shop counter, where fresh products of different kinds are constantly replenished. Every kind is on the counter represented by one piece (e.g. one roll, one pie, ...). Every product on the counter is labelled by an exact time of manufacture (in our case with accuracy in fractions of seconds). The counter can be supplied by a number of different suppliers, however, each of them has their own products that nobody else supplies (e.g. buns and rolls and produce). We can pick the products on the other side of the counter any time we want. If we take a specific product, the supplier immediately replaces it with a next one. The new product can, however, have the same time of manufacture, as the one we have previously taken. Let us imagine that it is from the same production series, the supplier just has at his disposal. From time to time the supplier gets a new series with a new origin time stamp. Then he offers the products from this series only, i.e. there is always only the freshest on the counter. We, customers, are on the other side of the counter, and want to monitor all the products on it. If we take the products, we are only interested in the ones with different manufacturing times. This means that we, always before taking the goods from the counter, check whether we did not take the product, with the given time of manufacture, already.

Measurement results from A3716 system and other process values from other sources are offered to an actual OPC server. A3750 continuously and cyclically takes values of chosen types offered on the OPC interfaces. If a new value shows up (i.e. loading time is higher than in the last value), it gets stored in a memory.

A3750 – Monitoring System

This summary name labels a group of software that ensure the whole above mentioned process. Two main software that work directly with the measured data are **Data Loader** and **Data Admin**.

Data Loader

- reads values form the OPC interface and stores them in the circular memory.

Data Admin

- reads values from the circular memory,
- stores the values in the target DDS databases,
- reduces the data in the DDS databases,
- evaluates critical limits,
- starts the process of the fast data storage during an extraordinary situation.

Data Viewer

Data Viewer is comparatively independent software that serves to display the last measured values, and can also show their short history. The values are shown in a well-arranged graphical form. A typical use of this is on a control station monitor, where an operator continuously sees actual measured values together with information, whether the values are acceptable or not. The **Data Viewer** reads the data from the circular memory, which means that it needs the **Data Loader** to run. However, it is independent from the **Data Admin** software.

We shall often talk about the "**project**" in the following text. Under this term we understand a summary of all settings, according to which A3750 monitoring system operates. These settings are stored in several files with the same name, but different extension.

Other software that shall be described later are intended for easy creation of the mentioned settings.

Data Status

It enables a user to follow work of the whole A3750 monitoring system.

A3750 Main Parts

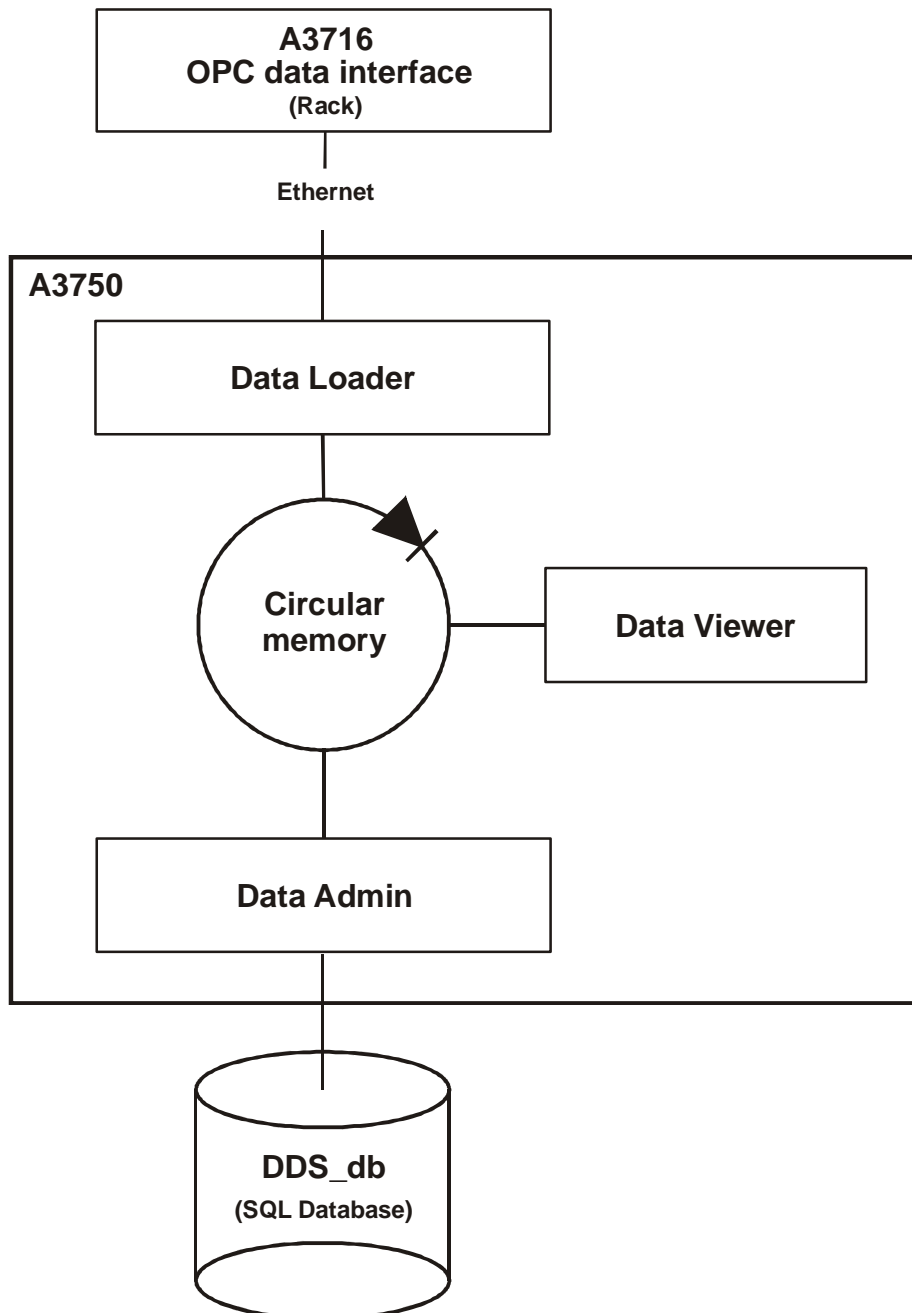

Static and Dynamic Measurements

Under the term measurement we shall thereafter understand all kinds of measurements available on the OPC interface. We are going to divide the measurements to static and dynamic ones to easier understand the following explanation.

A static measurement is represented by one or several values only. Examples are:

- measurement of machine speed is a one-value measurement,
- measurement of a shaft position in a bearing - Centre line is a two-value measurement,
- Aps measurement (i.e. measurement of amplitude and phase on a machine speed frequency) is a three-value measurement.

The dynamic measurements are represented by an array of measured values, for example:

- time signals,
- spectrum,
- order analysis.

Control Measurements

We are going to talk about significance of some static measurements in this paragraph. Not all measurements available from the OPC interface have the same significance. For example, amplitude and phase values of the third harmonics are definitely less significant than an Smax value. We understand higher or lower importance so that a change of the measured value is more or less significant for a total operational status of monitored equipment. The important measurements primarily are Smax and machine speed. For both of them it is very easy to determine value ranges acceptable for a good (i.e. "normal") operational status. If these measurements acquire unacceptable values, it means an extraordinary situation. Such situation requires a different type of a data collection - just the one, we have mentioned above - the second level collection with no, or little, reduction.

The measurements that are used to control (i.e. start or stop) the data collection on the second level, we call the **CONTROL MEASUREMENTS**.

Normal and Abnormal Machine Operation

We mark a machine operation as **Normal**, if all control measurements have acceptable, i.e. "normal" values.

If at least one *control* measurement acquires unacceptable values, we call the machine operation **Abnormal**.

Grouping of Measurements

Once you start creating projects, you shall find out that all measurements you want to monitor, fall into many groups. A basic property of each group is, whether it contains measurements only for a normal, or only for abnormal machine operation.

Characteristic signs of each "Normal" group are:

- the same data storage time period (for example 5 minutes),
- a level of used reduction.

Characteristic signs of each "Abnormal" group are:

- the same data storage time period (for example 5 seconds),
- a level of used reduction,
- a list of control measurements,
- acceptable values for each control measurement,
- how much data is stored before the origin of an extraordinary event (the origin is the time, when the first control measurement changes value from acceptable to unacceptable),
- how much data is stored after the end of an extraordinary event (the end is the time, when the last control measurement changes value from unacceptable to acceptable),

After the first reading you may think that there are possibly only two groups. This is not likely. For example, in normal operation you shall request to store the static measurements every 5 minutes, order analyses every 30 minutes, and time signals every hour. This way you shall create three normal groups. It is the same for the abnormal ones, in addition, they shall differ by a used control measurement (or by a list of control measurements). The groups can be also differentiated by monitored machines. A whole group can be easily switched on or off in the A3750. This is very useful during outages.

Each group controls data collection. The abnormal groups control the data collection ONLY during an abnormal operation. The normal groups control the data collection continuously, i.e. during normal and abnormal operations. They are not switched off during the abnormal operation! A reason for this is a request for uninterrupted data trends in a target normal database.

The creation of the groups represents an elegant solution to how to simply and efficiently define data collection conditions. It is enough to define characteristic signs once for each group, and also all the measurements, for which they shall be used. Thus defined measurement groups are a one of basic building stones of a A3750 project. They are designated **TCG** (Time Controlled Group) in the following text.

A normal operation **TCG** shall be called **NORMAL_TCG** in the following text.

An abnormal operation **TCG** shall be called **ABNORMAL_TCG** in the following text.

Measurement Reduction

Data can be reduced in target databases. This is a similar process as for a picture lossy compression. We all know the jpeg format. The objective of a compression is to lower a volume of stored data. In general such procedure works as follows: If measurement values are sufficiently similar, then it is possible to keep only one representative value. Such lossy compression shall be called "**reduction**" in the following text.

The reduction in A3750 allows a user to set so called significant change value in case of static measurements. This value is in %, and, for example, a change smaller than 10% against a reference value is not significant. The reduction set this way lowers the data volume at a time of a stable operation. However, in case of significant value changes, it stores sufficient amount of data, so that the user obtains complete information.

Additionally the reduction is divided into three time intervals. They are:

- data interval without reduction (e.g. up to 7 days old),
- short-time reduction interval (e.g. 7-21 days old data)
- long-time reduction interval (e.g. data older than 21 days)

The significant change value can be set differently for each reduction interval.

DDS Database

We have talked about the target databases as about DDS databases. This designation stems out of the fact that we use a DDS software for further data analysis (included in A3750). That is why we do not talk about the target database, but about DDS database in the manual. It is always designated as **DDS_DB**.

There is usually more than one target database, that is why the DDS_DB is only a database type, not the designation of one individual database.

Similarly as with TCG, we divide the DDS databases into normal and abnormal. According to TCG group types that control the data collection into the particular DDS database, the particular database is of the same type.

NORMAL_TCG controls the data collection during both types of operations, and the measurements mentioned in it are continuously stored in the target DDS database, called **NORMAL_DDS_DB** in the following text.

There is usually more than one **NORMAL_TCG** type group created. They all store the data in the same **NORMAL_DDS_DB**; there is always only one **NORMAL_DDS_DB** in operation.

ABNORMAL_TCG controls the data collection only during an abnormal operation (when it is started by its control measurement), and the measurements mentioned in it are continuously stored in the target DDS database, called **ABNORMAL_DDS_DB** in the following text. All working **ABNORMAL_TCGs** (they may, for example, differ by storage interval periods) store the data in the same **ABNORMAL_DDS_DB**; there is always only one **ABNORMAL_DDS_DB** in operation during abnormal situations.

DDS

DDS software is intended for work of a diagnostic, who is able to process the data stored in the DDS database into well-arranged diagrams. This is a general software that enables to process not only data from the A3716 online measuring system, but from other measuring systems and vibration measuring instruments as well.

Level 2

List of Terms for A3750

Introduction

For easy orientation in the **Level 2** chapter of the manual, it is necessary to know meanings of used terms. We shall explain them in relation to the **Level 1** chapter, where we have basic descriptions of processes that run in A3750.

We need to set the system to have the A3750 functioning properly. All parameters are stored in several text files, it means that they can be opened and read by many common software (e.g. Notepad in Windows XP).

We need to register several services in a computer in order to have A3750 functioning properly. If this sentence is not quite clear to you, do not worry. Services are software, just like other ones we are used to. Only they start automatically during a Windows system initiation and run before a user is logged on.

We have already mentioned a term Project. This includes both files, and registrations. We are talking both about a whole A3750 project, and about partial projects belonging to individual software.

We also talk about databases, abbreviated as DB further in the text.

Databases

Online DB - Circular Memory

So far we have talked about a circular memory, into which a **Data Loader** service stores data. Also this memory has a database structure, and we shall call it Online DB in the further text. A data cell is its basic building block.

An empty Online DB is created in the **A3716 Setup** software during a set up of a new project. The **Data Loader** service creates the cells in the empty Online DB.

The Online DB works as a circular memory, into which the **Data Loader** service stores measurement data from the OPC interface, and so creates a time history with defined length. All measurements defined in a configuration file of the **Data Loader** are stored in the circular memory without any reduction.

Template DB- Template for DDS Databases

A **Data Admin** service creates a new DDS database and its measurement structure (tree), as a copy of Template DB.

A **Data Admin Project Editor** creates and maintains the Template DB. It makes sure that during creation of a new project the corresponding Template DB shall be created and that newly defined measurements shall be added into the already existing Template DB. So a user does not have to worry about Template DB maintenance with one exception: The **Data Admin Project Editor** creates all new data cells in a database tree root. If the Template DB (and consequently Normal DB and Abnormal DB) does not suit to the user as a mere list of the data cells in the database tree root, user must maintain the tree structure, which means that user must always move the cells, using a **DDS**

software, from the database tree root into a required tree branch, after an editor adds the new data cells.

DDS DB

The measured data are stored into DDS databases by the **Data Admin** service. Individual TCGs (see reduction and a TCG definition file for the **Data Admin**) define what measurements and with what reduction should be stored.

We recognise two types of the DDS databases, according to a type of the TCGs, which control storing of the data into the databases:

- Normal DB,
- Abnormal DB.

Both database types are created as copies of the Template DB in the beginning.

Normal DB

This is the DDS database, whose data storage is controlled only by TCGs of the Normal TCG type. The new (empty) Normal DB is always created by the **Data Admin** service, unless it finds an already existing Normal DB to store the measured data. The Normal DB tree is created as a copy of the Template DB tree.

Abnormal DB

This is the DDS database, whose data storage is controlled only by TCGs of the Abnormal TCG type. The new (empty) Abnormal DB is always created by the **Data Admin** service, if the service finds that a monitored equipment operation changed from normal to abnormal. The Abnormal DB tree is created as a copy of the Template DB tree. The existing Abnormal DB is closed and cast aside by the **Data Admin** service, if the service finds that the monitored equipment operation returned from abnormal to normal.

Project

The Project of A3750 monitoring system is created in the **A3716 Setup** software and includes:

- project file with **dmi** extension (it contains global parameters for the whole project),
- creation of empty Online DB,
- registration of **Data Loader** and **Data Admin** services on a computer,
- configuration of **Data Loader** service
- configuration of **Data Admin** service

The Data Loader is configured directly in **A3716 Setup** and includes:

- configuration file of the Data Loader project with **ldi** extension.

The Data Admin is configured in the **TCG Editor and DataAdmin Project Editor** software and includes:

- configuration file of the Data Admin project with **adi** extension,
- file of reduction and TCG definitions for the **Data Admin** with **tcg** extension,
- creation of Template DB.

Managing projects

A3716 Setup

Main parameters for A3750 are entered in this software. The software also initiates other software and services.

This is the highest level for:

- creation of a new project,
- creation of a new Online DB,
- creation of a **dmi** configuration file for the new project,
- maintenance of existing projects,
- intermediate control (starting / stopping) of **Data Loader** and **Data Admin** services

Creation of New Project in A3716 Setup

A user, creating a new project, must have informations necessary to create every new project. There are two types of this information:

1. Information about installation of OPC and SQL servers.
2. Necessary information about settings A3716 measurements.

ad 1. If the users do not perform these installations themselves, they have to read the following information from the specification protocol:

- computer name, instance of SQL server used on this computer, username and password to log on onto the SQL server,
- directory path for placement of an Online DB and SQL server log file, unless these paths are standard (see Alternative Path further),
- computer name and instance of OPC server used on this computer.
 - o predefined computer name is in following format – “A3716_XXXXXX” where XXXXXX stands for serial number of the A3716 rack(this information is on the of rack)
 - o on A3716 the OPC instance is “AOPC_A3716”

Procedure to create a new project:

1. Entering of a project name **PrjName**. From it are derived:
 - Data Loader project name (to register Data Loader service),
 - Data Admin project name (to register Data Admin service),
 - Project configuration file name **PrjName.dmi**,
 - Data Loader configuration file name **PrjName.ldi**,
 - Data Admin project configuration file name **PrjName.adi**,
 - TCG definitions file name for Data Admin **PrjName.tcg**,
 - Online DB name **PrjName_online**.

The user must name only Normal DB and Template DB. If the names of these databases were tied to the project name, it would preclude use of the same Normal DB for more monitoring systems, i.e. a possibility of data collection from more OPC interfaces. Such limitation is not desirable.

2. Assignment of OPC server
 - name of a computer, where is the OPC server installed(A3716-SerialNumber),
 - instance of the OPC server on the chosen computer (AOPC_A37160).
3. Setting of parameters for SQL server and creation of empty Online DB. **ATTENTION!**
 - name of a computer, where the SQL server is installed,
 - instance of the SQL server on the chosen computer,
 - username and password for a user logon to the SQL server,
 - directory paths for the **Alternative Path**, unless they are standard (however, they should not be standard, with regard to recommendation that an Online DB should be located on a different physical volume).
4. Entering of NormalDBName name for the Normal DB, from which a Template DB name is derived as NormalDBName_template.

5. Creation of the **adi** configuration file and Template DB by the **Data Admin Project Editor** software (by clicking on a single button).
6. Creation of the **tcg** reduction definitions and TCG definitions file by the **TCG Editor** software.

Addition of New Measurements into Existing Project in A3716 Setup

1. Selection of the project through **A3716 Setup**
2. Creation of new measurement definitions in **A3716 Setup**
3. Addition of new measurements into Template DB, and creation of database connections for new measurements via **Data Admin Project Editor** into **adi** file (by clicking on one button).
4. Addition of new measurements into Normal TCG, and eventually into Abnormal TCG, via **TCG Editor**.

Data Admin Project Editor

This represents a complete Data Admin project **adi** file maintenance system for experienced users. However, if it is invoked from the **Data Admin Setup** software, which gives it most of necessary information itself, it enables an easy work with the files for a regular user.

Input **Idi** configuration file of Data Loader project.
Outputs **adi** configuration file of Data Admin project and Template DB.

TCG Editor

This represents a complete Data Admin project **tcg** file maintenance system for experienced users. However, if it is invoked from the **Data Admin Setup** software, which gives it most of necessary information itself, it enables an easy work with the files for a regular user.

Inputs **Idi** configuration file of Data Loader project and **adi** configuration file of Data Admin project.
Output **tcg** file of reduction and TCG definitions for **Data Admin**.

Files

dmi File –Project Configuration File

This file contains global settings for the whole project. All A3750 monitoring system software can then take its information from one source only – from this file. The file is created by the **A3716 Setup** software during creation of a new project.

Idi File - Configuration File for Data Loader, Loader Ini File

This is the measurement definition file that the **Data Loader** service should transfer from the OPC server to the circular memory (Online DB).

It is an output of the **A3716 Setup**. A Data Loader does not work without it.
It is an input for **Data Admin Project Editor** and **TCG Editor** software.

adi File - Configuration File for Data Admin, Admin Ini File

This is a database connection and other parameters file to set the **Data Admin** service.

It is an output of the **Data Admin Project Editor** software. A Data Admin does not work without it.
It is an input of the **TCG Editor** software.

tcg File - TCG and Reduction Definition File for Data Admin, TCG Ini File

This is a TCG and reduction definition file to set the **Data Admin** service.
It is an output of the **TCG Editor** software. A Data Admin does not work without it.

A3716

A task of A3716 is to measure analogue signals from protection systems or from directly connected sensors. Practically it consists of fast computer with specialized HW for measuring and software for collecting the data.

A3716 HW



Dimensions:

Standard 2U rack

Inputs:

4 measuring modules A,B,C,D = 16 channels AC + 16 channels DC.

Each module contains 4 AC channels with optional ICP powering + 4 DC channels + Tacho

The AC inputs measure max. voltage peak $\pm 12V$ (24-bit A/D conversion)

The DC inputs measure max. $\pm 24V$ (12bit A/D conversion)

Tacho input max. 10V (above 10V the signal is limited)

ICP powering 18-20V / 3.8 mA can be enabled by software.

Warning : Do not enable ICP powering when NON ICP powered signal source is used. It can cause permanent damage to the connected signal source.

Absolute maximum ratings

(Stresses above the values may cause permanent damage to the instrument hardware.)

Any AC or DC input max. $\pm 30V$ peak

Tacho input max. $\pm 48V$ peak

Accessories inputs :

LAN, ps2 – mouse/keyb, vga, usb...



Terminal block

AC signal inputs **AC-1, 2, 3, 4**, where "+" terminal is signal input and also positive ICP powering voltage, "-" terminal is common signal ground and also negative ICP powering voltage. ICP powering has to be enabled if needed.

DC signal inputs **DC-1, 2, 3, 4**, "+" terminal - positive voltage, "-" terminal - negative voltage. The polarity of the DC signal can be reversed.

U20+ = $+20V_{DC} \pm 10\%$ / 10mA, negative pole of the voltage is common signal ground.

U5+ = $+5V_{DC} \pm 10\%$ / 50mA, negative pole of the voltage is trigger signal ground.

TRIG - trigger signal input, where "+" terminal is positive signal input and "-" terminal is common trigger ground. Triggered voltage level is software adjustable. Negative trigger voltage cannot be directly measured.

NC = Reserved

We do not recommend to connect AC and DC common signal ground to trigger signal ground.

Front panel contains:

Power switch, Hard Disc Drive indicator, System reset button, Status indicator for each measuring module and channel indicator (Ch1-16) for each measured channel.

A status indicator should be green. If it is red, license checking or measuring module hardware failed. A channel indicator should be also green when channel is in use. If it is red it indicates ICP powering error (broken cable or sensor, sensor not connected ...).

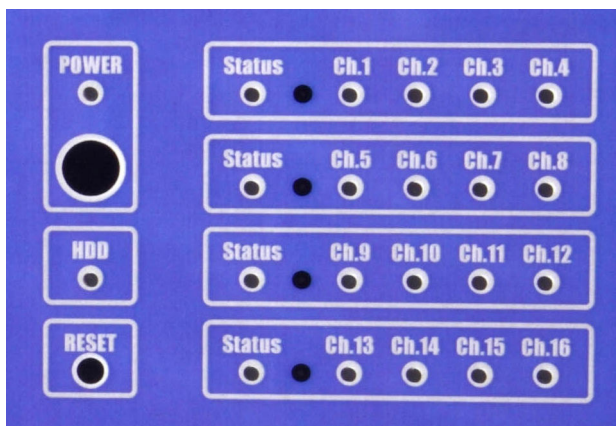

A3716 SW

Simplified scheme

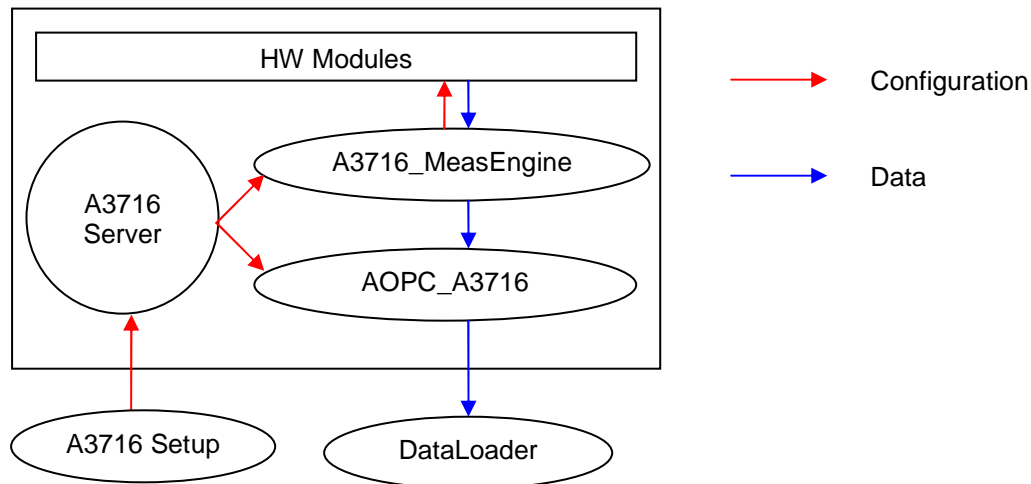

System

On A3716 is installed Windows so the entire measuring process can be easily monitored and maintained with standard equipment like RDP...

Manufacturer setup

- LAN
 - o The computer has pre-set name A3716_SERIALNUMBER.
 - o IP Address 192.168.1.xxx
 - o Subnet 255.255.255.0
- USERS
 - o Predefined user OPC(for OPC-DCOM purposes)
 - o Predefined user "remote" with password "remote"
- A3716 Software
 - o Placed in c:\A3716\ folder.
 - o Consist of A3716_MeasEngine, A3716 server and AOPC_A3716

A3716 Folder structure

C:\A3700\

- | | |
|----------------------------|----------------------------------------|
| - A3716_Reg.exe | - registering A3716 Server into system |
| - A3716_Server.exe | - A3716 Server service |
| - A3716_Server.log | - A3700 Server log |
| - AOPC_A3716.exe | - AOPC_A3716 OPC Server module |
| - A3716_Monitor.exe | - A3716 Server Monitor |
| - \bin | |
| o A3716_MeasEngine.exe | - A3716 program for data acquisition |
| o \VA4coef | - LP/HP filter coefficients |
| o A3716_SignalAnalyser.exe | - interface for quick signal analysis |
| - \data | |
| o script.a37 | - configuration of data acquisition |
| o \VA4log | - logs of A3716_MeasEngine program |

A3716_MeasEngine

A3700 purpose is to configure the measuring HW and for collect data from it. The data are exposed into shared memory (where from they are being collected by **AOPC_A3716**). This program is being monitored by **A3716_Server** and in case if this program crash, **A3716_Server** restarts it immediately.

A3716_Server

A3716_Server is program working as a watchdog for **A3716_MeasEngine** and is responsible for setting the configuration for the **A3716** (measuring HW). On one A3716 hardware can run just one **A3716_Server**. Communication runs over network as a TCP server on port 37160 and is awaiting commands from **A3716_Setup** like configure new measuring or restart the system. E.g. when it receives the information that the configuration has changed it stores new configuration into script.a37 stops **A3716_MeasEngine** and OPC interface and starts A3716 with new configuration.

As a service it has some advantages and disadvantages. The advantage e.g. is can run when no one is logged into the windows. Disadvantage is that the program must be registered into system before it can run. There is a simple command line program created for registering **A3716_Server** into system called **A3716_Reg.exe**. **A3716_Reg.exe** must be placed in the same folder as **A3716_Server**.

A3716_Reg parameters

-register	- registers A3716_Server.exe into system
-unregister	- unregister A3716_Server.exe from system
-start	- starts A3716_Server service
-stop	- temporarily stops A3716_Server service

AOPC_A3716

Is a program providing standard OPC interface between **A3716_MeasEngine** and any OPC Client. It communicates with the **A3716_MeasEngine** through shared memory and DataLoader through network. In one system can run multiple instances of **AOPC_A3716**. Like **A3716_Server** this program is not usual program but the DCOM object. But unlike **A3716_Server** it can register by itself. It can be registered in command line by calling the **AOPC_A3716.exe –RegServer**. Usually we need to register the OPC server only once on the fist system installation.

But because we need OPC server to communicate through network we must set the rights for this DCOM object in the system.

One of key features of A3750 system is that A3716 provides interface for quick analysis of vibration signal that does not requires any deep knowledge of the whole system. This interface is called **A3716 Signal Analyser**. It is accessible directly on the A3716 rack. If the A3716 has attached usual computer accessories (Monitor, keyboard, mouse...) then you can log into the computer as user "remote" or if the A3716 rack is connected through network you can log in from other computer using "Remote desktop" (RDP). On the desktop you will see the small program **A3716 Server Interface**. In this program you can initiate the **A3700 Signal Analyser**.

Warning - **A3716 Signal Analyser** requires that **A3716_MeasEngine** software is not running – this means any projects collecting data from this particular A3716 will be stopped. When you stop working with the **A3716 Signal Analyser** start the A3716 again!

A3716 Server Monitor

Is a program intended to ease running **A3716 Signal Analyser** and basic system diagnostics. On the top of list is the instrument A3716 and below it there is a list of measuring cards with their status indicating basic problems (overload, icp problems, hw problems..). To start the Signal Analyser first press "Stop" button – this stops **A3716_Server** and **A3716_MeasEngine**. Now A3716 cannot be configured remotely with **A3716_Setup**! After the measuring is stopped you can run A3716 Signal Analyser. After you exit Signal Analyser press "Start" button to start **A3716_Server** and **A3716** again!

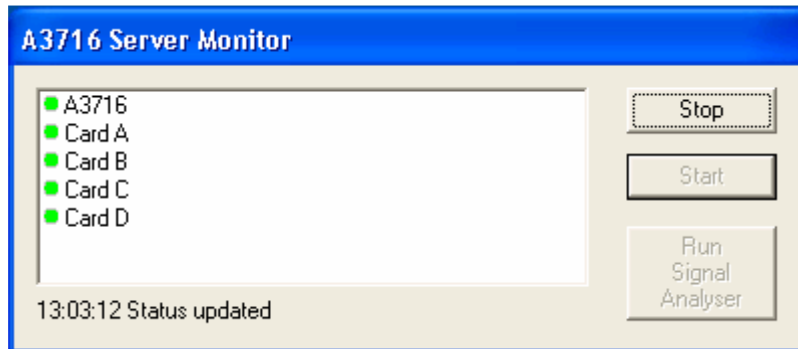

A3716 Signal Analyser

A3716 Signal Analyser is a program for quick signal analysis. It has very similar interface to our VA4Pro instrument. Here you can configure your own measuring set and see what is happening on the inputs on A3716. This data are not stored anywhere so you can experiment with the setup without affecting any projects running on this A3716. When **A3716 Signal Analyser** starts, it loads the configuration from the last running project.

A3750 Installation

In this chapter we shall find out, what kind of computer to use for operation of the monitoring system, and how to install A3750 software on it simply.

Computer Requirements

This chapter shows minimum requirements for hardware and software of a computer, on which we operate the whole A3750 monitoring system. These requirements cannot be universally prescribed. Certainly they are going to be quite different in case that we operate one relatively small project on the computer, as opposed to several large ones.

General Recommendations

The following principles should be kept without regard to size of operated projects:

- The whole computer should be reserved only for operating of A3750 monitoring system, including all of its possible expansions.
- New hardware should be used, with a new installation of the operating system.
- When you install the operating system, install only parts that are necessary for using the A3750 monitoring system.
- Install only software that are necessary for operating the A3750 monitoring system and software necessary for setting and testing of hardware operation of the A3716 measuring system.
- Limit number of concurrent users that can access the SQL server from the outside through a network to a necessary minimum in SQL server settings. They are users of **DDS** software (processing of DDS database data) and **Data Viewer** (online visualisation of selected data from the Online DB). A large number of users simultaneously accessing the databases can overload the SQL server and slow down the system.

Hardware

Hardware requirements depend on data collection requests for a specific project. The system load depends primarily on these parameters:

- Online database history length (see parameter **Online History** in the chapter **Data Admin Project Editor**),
- frequency of data transfers from the Online DB to the DDS databases (see parameter **Transfer Period** in the chapter **Data Admin Project Editor**),
- amount of data in the DDS databases.

We generally recommend

- two core, 64 bit processor,
- minimum of 1 GB RAM (2 GB or more recommended),
- two physical discs on SQL Server machine
- A3716 rack connection with the computer over gigabit network.

Software

- supported OS are Windows XP 32bit, Windows Vista 32/64-bit, Windows 7 32/64-bit and Windows Server 2003 or 2008
- supported SQL Servers are MS SQL Server 2005 and MS SQL Server 2008

A3750, Including Related Software

The basic software of A3750 monitoring system are the following programs -

Data Loader service that transfers measured data from the OPC interface to the Online database.
Data Admin service that transfers data stored in the Online database to the DDS databases.
Data Status software to control and monitor working of the whole system.

To ease the configuration and registration of these programs there are -

A3716 Setup Software to create a project and configuring measurements (Idi).
Data Admin Project Editor Software to create and maintain the **adi** configuration file of the **Data Admin** service and to create and maintain template of the DDS databases.
TCG Editor Software to create and maintain the **tcg** file of TCG and reductions definitions of the **Data Admin** service.

For quick visualization of the Online database we provide -

Data Viewer software to online monitor selected data stored in the Online database.

For analysing of the data stored in the DDS databases we need another software, which is not a part of the A3750 monitoring system. It is a universal software to archive, visualise and analyse data measured by both manual instruments, and online measuring systems.

DDS software to visualise and analyse data stored in the DDS databases.

The A3750 uses support of some other software for its work. Although their installation is not a subject of this chapter, they are necessary for its work, and the A3750 will not work without their previous installation and activation on a computer. They are these software:

SQL Server Software for work with SQL type databases.
OPC Server Software to transfer data between A3716 measurement system hardware and the PC, where should be the A3750 monitoring system installed.

Working Directory

Data Admin and **Data Loader**, which are the backbone of the A3750 monitoring system, are not common software, but **services**. Thanks to this they are capable of running immediately after starting a PC, before any user logs on the system. This characteristic ensures that after a PC is restarted (for example after a power outage), work of the A3750 monitoring system starts automatically. The services, however, have certain limitations that must be respected. One of them is the need to be registered on the PC. This is automatically done by the **A3716 Setup** software, which registers both services during a start-up of a new project.

ATTENTION!

Your computer operating system will register the services, including their actual directory paths. After the PC is restarted the operating system will look for the services at these paths to start them. If you create a project and then move the A3750 directory someplace else on the disk, the project will be visible and editable, but you will **not be able to run it**. Its **Data Loader** and **Data Admin** services will not run, since they are not found on their original registered paths.

To ensure safe work with the services, we have introduced the **working directory**, in which key software of the monitoring system must be located.

Structure and Placement of Working Directory

We recommend that you name the working directory **A3750** and place it on **C:** disk as a standard, to the directory path **C:\Program Files\Adash**.

The working directory must have the following files installed in it: **Data Loader**, **Data Admin**, **A3716 Setup**, **Data Admin Project Editor** and **TCG Editor**.

After they are started:

- The editors will create, or look for, their configuration files (extension **cfg**) in the working directory.
- The **Data Loader** and **Data Admin** services will create their log files in the working directory (extension **log**), into which they will write all their reports. The services do not have any user interfaces. Their work can be monitored only through the **Data Status** software, which is a part of the A3750 monitoring system, and in case of a defect the reports written in the log files can help to find it.
- During creation of a new project the **A3716 Setup** creates a subdirectory in the working directory with a name of this project (the picture shows the name PrjName), and places all the project configuration files in it, i.e. files with dmi, ldi, adi and tcg extensions.

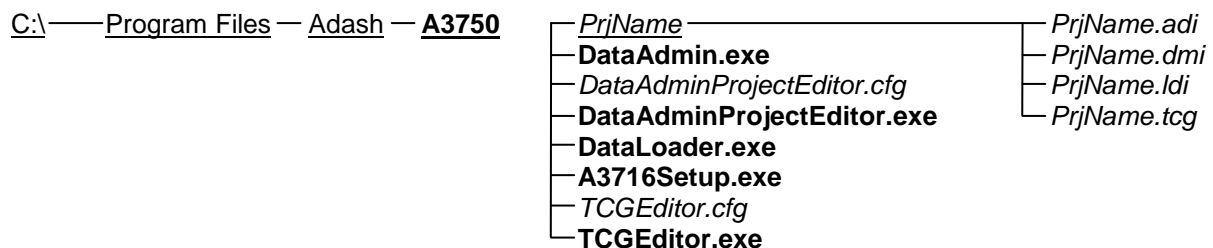

Adash subdirectory, not file (underlined)
PrjName, *PrjName.adi* is not created during installation, but after start of some software (italics)
DataAdmin.exe part of installation (in bold letters)

Licences

For protection of our software we developed the system of "Licences". These Licences (licence files or **aky** files) are bound with hardware protection key called "HASP". That means if you want to run the A3750 software you need the HASP key and a licence files for this particular key (the licence files cannot be used with any other HASP key).

Protected programs are -

- DataLoader** can connect only the OPC servers that are specified in the licence file
Licence name - DataLoader.aky
- DataAdmin** can transfer into DDS only data collected from specified OPC servers
Licence name - DataAdmin.aky
- DataViewer, DDS2010** because they are not the essential parts of A3750 monitoring system and are can be ordered separately they are also protected by licences.
Licence name - DataViewer.aky and DDS2010.aky

The licence files are placed in the same folder as the protected program. If you want to change licence e.g. add a new A3716 into system contact us and we will send you new licence file (typically in email).

And that is all!

The monitoring system is now prepared to create the first project on your PC. In the next chapters you will find out how to create it.

A3750 Project

Under this term we understand a summary of all parameters, according to which a A3750 monitoring system operates. These settings are stored in several files with the same names, but different extensions. The files are in a text format, it is possible to read and edit them with other software, but we recommend using our programs (Editors) to avoid problems.

Information Necessary for Creation of New Project

In order for the user to be able to create the new project, user must have the following information:

1. Instance of used SQL server, username and password.

This information was provided by a person, who installed the SQL server (Database Administrator).

Example:

SQL Server=(local)	SQL server on a local computer
User=sa	system administrator
Password=adash	password adash

2. Computer name and instances of used OPC servers (A3716 racks).

Example:

Computer Name=A3716_623178	name of an computer, on which a selected instance of the OPC server runs
Instance=AOPC_A3700	predefined OPC server on A3716 rack

3. Measurement list.

This is specification of required measurements from A3750 system and where they can be acquired (A3176 rack and channels).

Example:

Wideband	mm/s 10-1000Hz on rack A3716_623178- channel A1
Spectrum	g 0-25600 on rack A3716_623178- channel B1

A3716 Setup

This software is used for setting of A3750 general properties that will be used by all other software. The services **DataLoader** and **DataAdmin** are registered and started from this software as well as the programs **DataAdmin Project Editor** and **TCG Editor** for setting the DataAdmin configuration.

Creation of New Project

Registration of the project on your computer and definition of global project parameters (creation of dmi file) and definition of requested measurements. This step is done in the dialog window of the **A3716 Setup** software, and it is described in this chapter.

Procedure to create a new project

Press "Create Project" button and input the name of the project. Fill Online DB Group boxes and press "Create" to create online database. Fill the Meas. interval and OPC interval boxes. Next step is described in chapter "Adding new A3716 into system". The descriptions of parameters are written below.

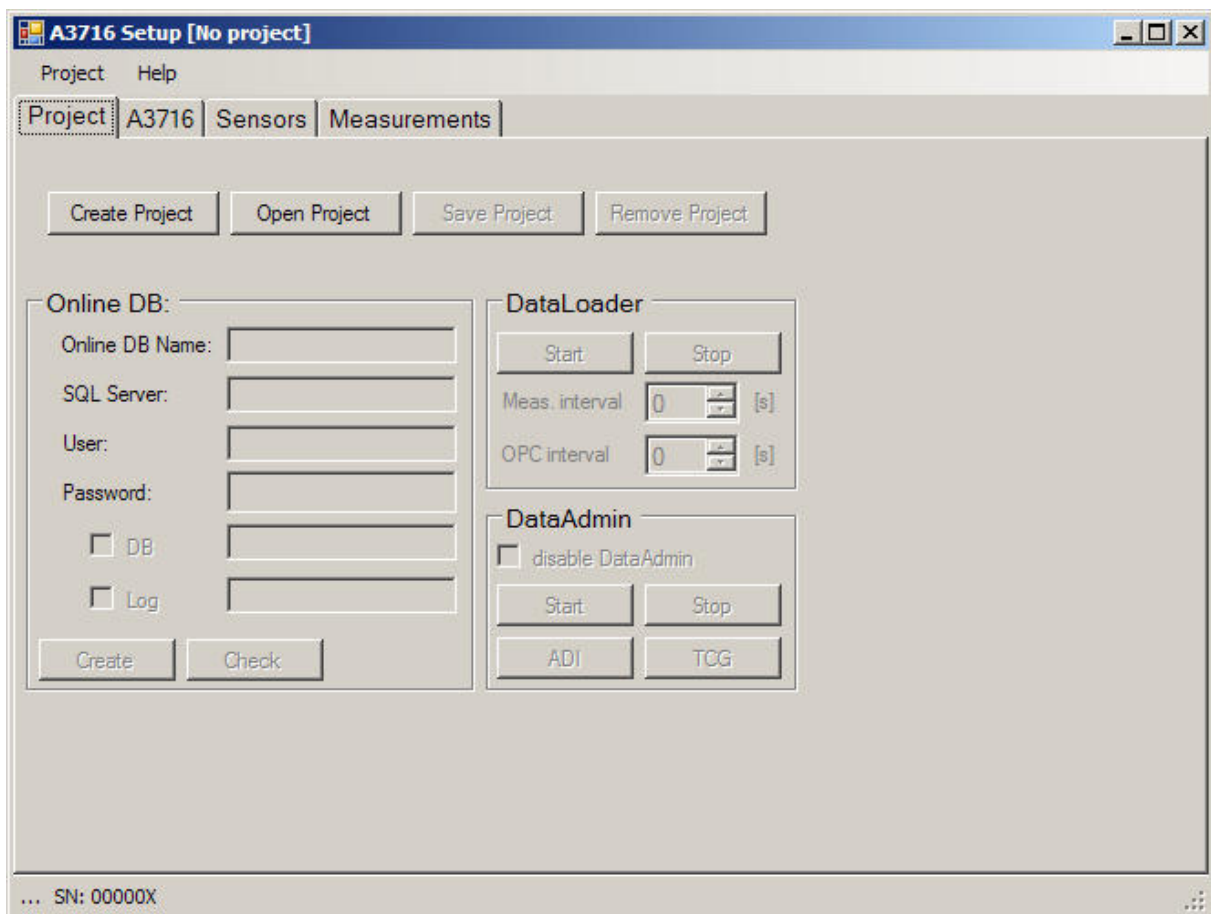

Parameters and Buttons of Online DB Group

Online DB Name	An Online database (circular memory) name is displayed in this information field. The Online database helps the Data Loader service to create unreduced (uncompressed) data history. The Online database name is created from the Project name by adding <code>_online</code> . The example on the picture shows the Online database name <code>DEMO_MMS_online</code> . Under the term Online database we mean an ODBC source name, under which the database is registered on your computer. This registration is performed by the monitoring system itself.
SQL Server	Write an instance of the used SQL server into this field. If the SQL server is installed directly on your computer, use the instance (local). We have used an external database server and the SQL server instance called <code>mms</code> in the example on the picture.
User, Password	Write the username and password, under which the A3750 logs in the selected SQL server, into these fields. In the example on the picture we used the user <code>sa</code> (system administrator), who is logged in under the password <code>adash</code> .
File Paths – DB, LOG	Check this field and write address paths to place the Online database and log files on a computer disk in neighbouring fields, if the paths are different from paths the SQL server standardly uses. In the example on the picture was the Online database created in the physical volume <code>e:</code> in the <code>SQL.db</code> folder. The SQL server log file was directed to the volume <code>c:</code> into the <code>SQL.log</code> folder. Both folders had to be created during installation of the SQL server, this means before creation of the Online database by clicking Create .
Create	You will create a new online database on the selected SQL server by clicking this button. The whole project can be created without the online database, but you will not be able to start it. That is why we recommend to create the new Online database immediately after entering of all the Online DB Group parameters.
Check	Clicking on this button tests connection of the Online database to your computer. If this test is successful, you may be sure that after you start a project the Data Loader service will connect to the selected Online database.

An objective of this software is to let the user create and maintain the **Data Loader** service configuration file (with `ldi` extension) easily. This file contains all parameter settings needed for the **Data Loader**.

Buttons in DataLoader Group

After you configure the measuring (described in next chapters) and create Online DB the data acquisition will be started by pressing the **Start** button. On configuration change DataLoader must be restarted to accept new parameters.

Meas. interval	This parameters means how often you need the measurings from the hardware. This option helps to reduce the size of online database (e.g. you want value every 5 seconds not all of them). Zero means that you want as much values as possible.
OPC interval	This parameter reduces the network traffic. It tells DataLoader how often he checks OPC server(A3716) for a new data. It is recommended to set this value smaller then the Meas interval to be sure that all values are collected.

Buttons in DataAdmin Group

If you are using just DataViewer and not the DDS check “Disable DataAdmin” button. This will disable the whole group. If you wish to use DDS, leave the button unchecked. **Start** and **Stop** buttons starts/stops DataAdmin’s work (shifting data from Online DB into DDS databases). **ADI** button starts **DataAdmin Project Editor** and TCG button starts **TCG Editor**. Their detailed description is below in chapters named after editors.

Adding new A3716 into system

In the previous steps we defined for A3750 project where to store collected data, in the next step we will show how to define where from we want to collect data.

1. Open the project you want to edit
2. Move to second tab “A3716”

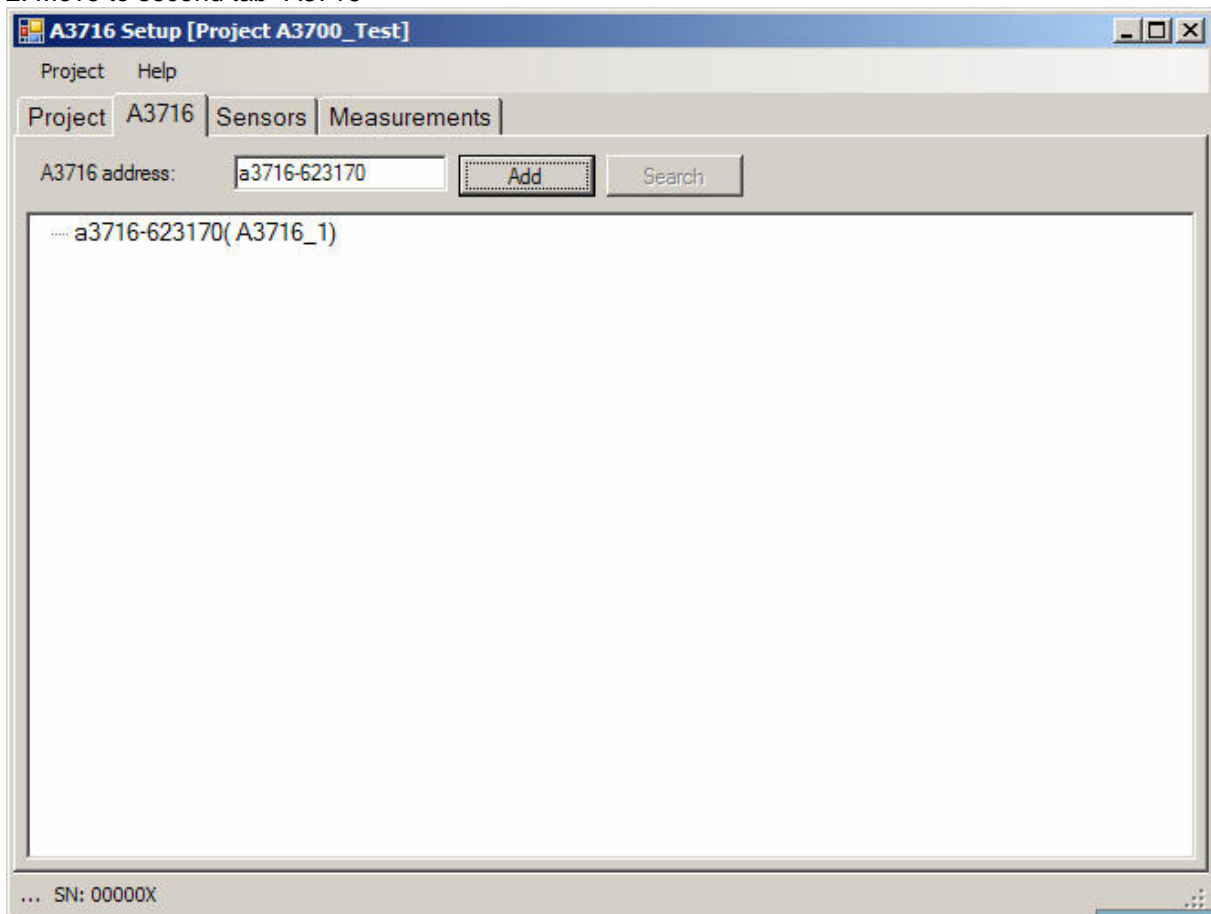

In A3716 address edit box input the network name or IP address of A3716 (A3716-SerialNumber) and press Add button. The A3716 must be already present on the network – **A3716 Setup** immediately checks if the A3716 is connected.

Sensors

When you connect the sensors to the A3716 rack, you have to tell A3716 what kind of sensors you use. This information is inserted into system in **A3716 Setup** in Sensors tab. As we described above there are 4 modules A,B,C,D and on each of them there are 4 channels AC/DC and Tacho channel. The **A3716 Setup** displays the sensors in a form of tree.

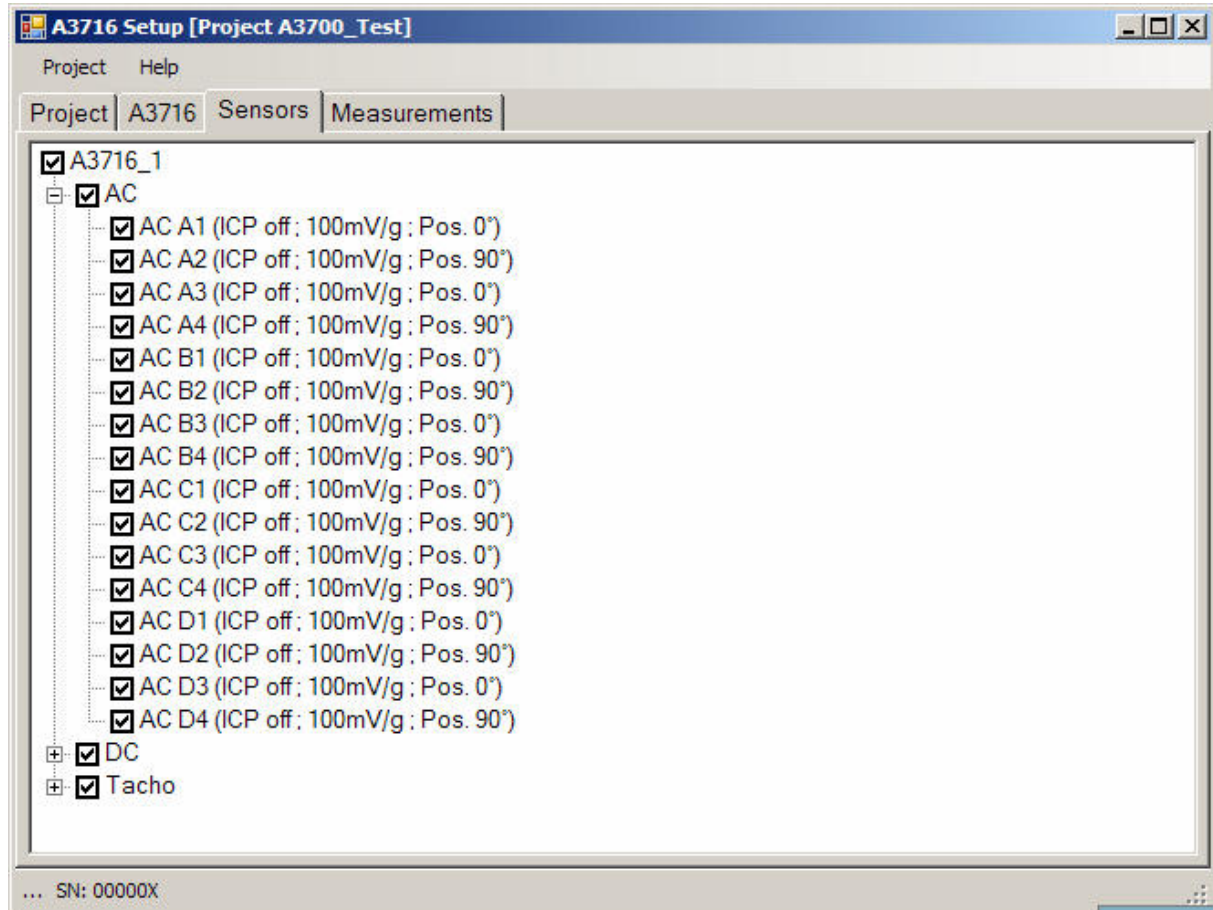

Every channel can be disabled by unchecking its checkbox – this will disable all measuring bound with this channel.

To change the properties for the channel double click on the measuring. This will enable changing the sensor settings. To change the settings of multiple channels at once press “right click” on the channel with requested parameters and press “Copy to”. It will show the list of channels – select the channels you want to change and press OK.

AC Sensor Properties

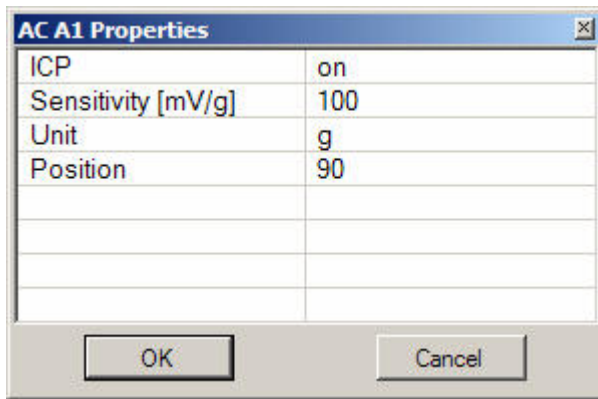

To change the property double clicks on it.

ICP **on, off** (selection of required setting accordingly the sensor type)
Sensitivity (mV/ selected unit) usually **1,10,100, user**
Unit select one of predefined units or if no one fits your sensor just enter your own
Position the angle of sensor (see picture bellow). Usually used for proximity sensors.

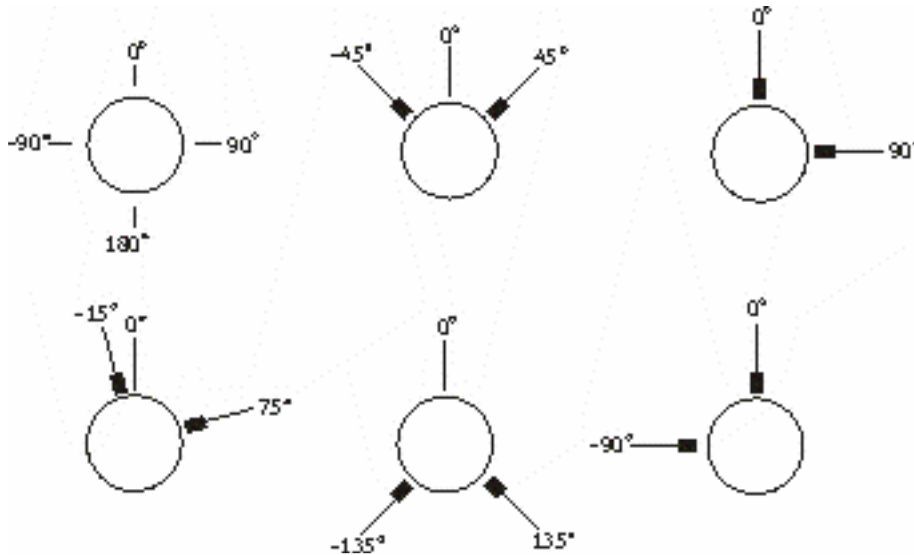

Sensor angles examples.

DC Sensor Properties

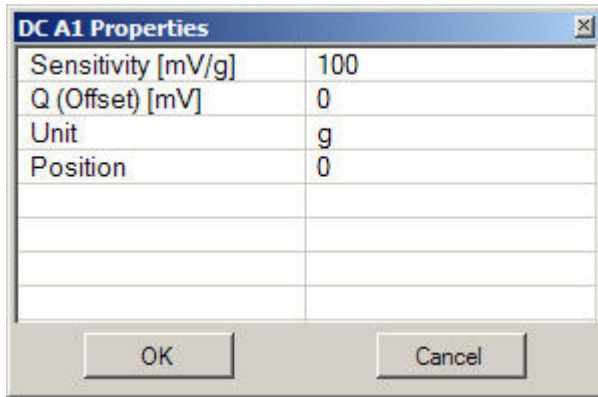

DC sensor properties are similar to AC sensor properties. The only exception is parameter Q(Offset) The value on this sensor will be calculated as Input/Sensitivity + Offset.

Tacho Properties

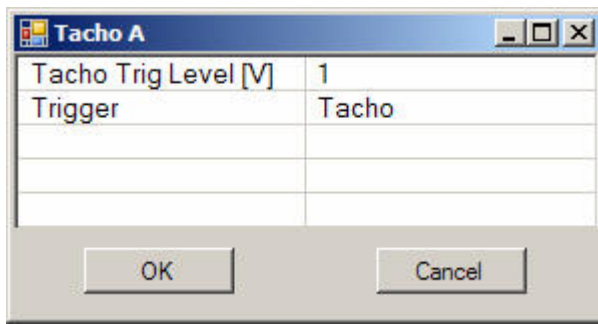

Trigger

freerun - taking of measured data begin immediately after preparation without waiting for anything.

tacho – the taking of measured data begins, when the external signal (voltage level higher then defined **Tacho Trig Level**) appears on the trigger input.

Tacho Trig Level[V] see previous section(tacho)

Creating the measurements list

Adding a new measurement into a list is a basic activity. The procedure is the same as with all the measurement types. We shall show the procedure on the adding of the TIME measurement type in the further text.

After the setting of sensors is done, move to next tab “Measurements”. To add new measurement click Add button. In dialog box “Add measurements to...” select appropriate A3716 rack and press OK.

Edit the measurement settings and confirm the changes with OK.

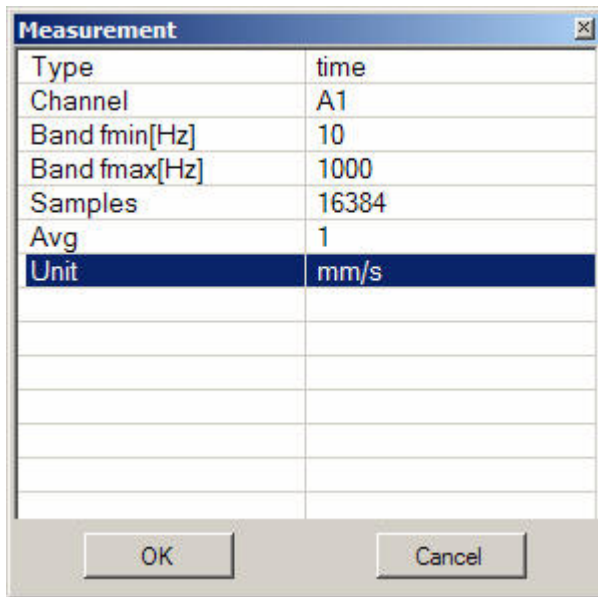

Now you will see the list of defined measurements.

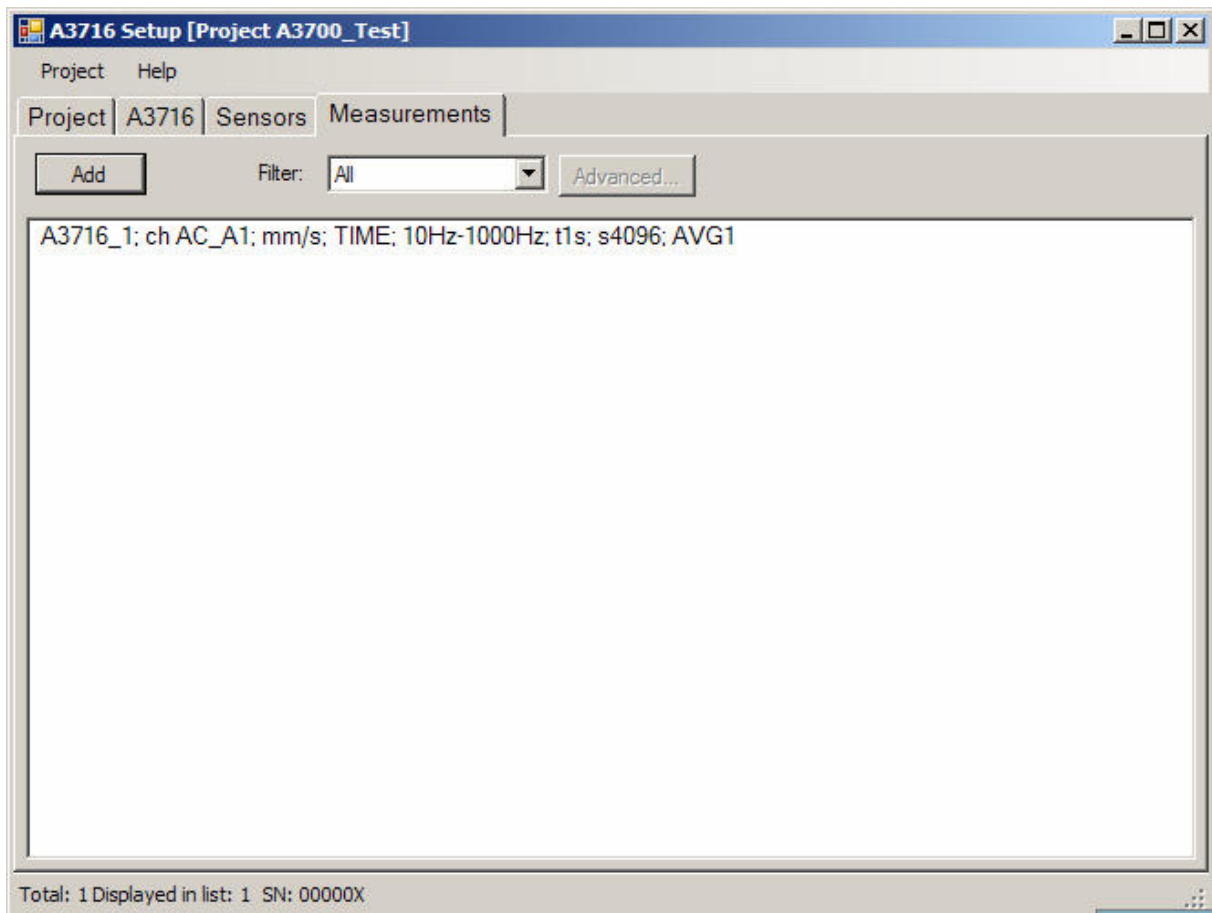

After you set all requested measurements save the project and start DataLoader – now the data are being collected into the online database.

Data Admin Project Editor

An objective of this software is to let a user create and maintain a **Data Admin** service configuration file (with **adi** extension) easily. This file contains a part of parameter settings needed for the **Data Admin**. Especially it contains a database connection of the Online DB (circular memory) to both DDS databases (Normal DB and Abnormal DB). Remaining parameters are contained in a TCG definition set (with extension **tcg**), for whose creation and maintenance we have the **TCG Editor**, described in the next chapter.

The **Data Admin Project Editor**, together with creation and maintenance of the **adi** configuration file, creates and maintains a common template of both DDS databases, designated in this text as the **Template DB**.

Template DB - DDS Databases Template

The **Data Admin** service stores measured data into two DDS databases:

- Normal DB is a database, to which data (according to parameters specified in Normal TCG) are continuously stored during normal as well as abnormal operation of a monitored device,
- Abnormal DB is a database, to which data (according to parameters specified in Abnormal TCG) are stored only during abnormal operation of a monitored device,

The **Data Admin** service creates both databases as needed, without user intervention, as copies of the DDS database template called the Template DB. This template is created and maintained by the **Data Admin Project Editor** during work with the **adi** configuration file. The editor creates and maintains it itself, without user intervention, as a list of data cells in a root of a database tree. Eventual structuring of the data cell list to the database tree branches is done by the user through the **DDS** software. How to move groups of newly created data cells to individual tree branches the most easily, will be described later in the chapter **Restructuring of Template DB Database Tree**.

In case that the Template DB (and consequently also Normal DB and Abnormal DB) satisfies you as a data cell list in the database tree root, you do not have to worry about it. It is hidden at a background of A3750 monitoring system work. However, this is good only for smaller amounts of stored measurements. In case you have a large number of these measurements, the list becomes hard to read and requires division into more branches of the database tree. In this case you have to create and maintain this structure from the data cell list.

The **Data Admin** service always ensures (after it is started) that the new cells, added to the Template DB by the editor, will be created in the Normal DB also. It will also, at the same time, ensure that the data cells that have been used so far, and transferred due to restructuring of the Template DB database tree from one branch to another, would be transferred identically in the Normal DB. The Abnormal DB is being created by the **Data Admin** service, always at the moment, when the first extraordinary situation occurs, according to the actual Template DB. This ensures synchronisation of the database tree between the Template DB and both DDS databases.

A user does not maintain the Normal DB database tree. User takes care of the Template DB database tree structure only.

Data Admin Project Editor

Editor is started from the **A3716 Setup** → **ADI** button. Most of the parameters are passed to the editor. You have already input these parameters during project creation in the **A3716 Setup** software, their descriptions are mentioned in the **A3716 Setup** chapter. In this software you can set following parameters –

Limits

Because the computers have limitations (disc sizes, disc speed, CPU speed, etc...) and the A3716 system can produce much more data than SQL server can handle there is a option how to input some limitations in the system.

Online History set a required length of measured data history in the Online DB. Unnecessary long history increases Online DB volume and slows down a **Data Admin** service response, which is not desirable. Therefore set only as many history hours, as you are going to use during a measured data analysis. The history makes sense only in case, when you run Abnormal TCGs, where you require recording of the data before occurrence of an extraordinary event. We recommend you set it to one hour.

Max. Normal DB Size set maximum size of normal database. If **Data Admin** detects that normal database reaches the limit - creates a new normal database with the same structure. This improves the responsiveness of the system.

Reduction

Described in the TCG editor section.

First reduction at sets when is the first start of the reduction. Because the reduction process may take a while this is a way to set when it begins typically when nobody is using DDS.

Reductions per day set how often the reduction will be performed during the day. E.G. when we set 2x the reduction will be every 12 hours.

Creation of New adi Configuration File and Template database

It is apparent from the picture that if you start the editor from the **Data Admin Setup** software, most of control buttons will be disabled, and that most fields are already pre-filled and their contents are not possible to change.

Save and Finish Clicking on this button will create a new **adi** configuration file in the **New Project** mode and a new Template DB at the same time.

Exit finishes the software. If the **Data Admin Project Editor** was started from the **Data Admin Setup** software, the software would finish itself after creation of the new project, and you will return back to the dialog window **Data Admin Setup**.

Restructuring of Template DB Database Tree

The **Data Admin Project Editor** creates a new Template DB as a mere list of data cells in a database tree root. Such list becomes hard to read for a larger amount of measurements, therefore needs to be divided to more branches of the database tree. Restructuring of the database tree is performed in the **DDS** software.

We are going to perform division of measurements in the Template DB in the further text, according to individual measuring cards, and within each card we are going to divide the measurements according to measuring channels. We have so far defined the measurement from only one card, which we designated **6110-1**, in a sub-project of the **Data Loader** service. Definitions of these measurements are specified in the **Idi** configuration file of the **Data Loader** service. This file is used as an input for the **Data Admin Project Editor**, which created data cells for the measurements in the Template DB, and database connections for them in the **adi** configuration file. We are going to divide the measurements further within one card into three database branches designated **Common** (speed measurement and two-channel AB measurements), **Channel A** (channel 1 measurements) and **Channel B** (channel 2 measurements).

Opening of Template DB

Through item **Database / Select and Open** you can open a table of all available databases.

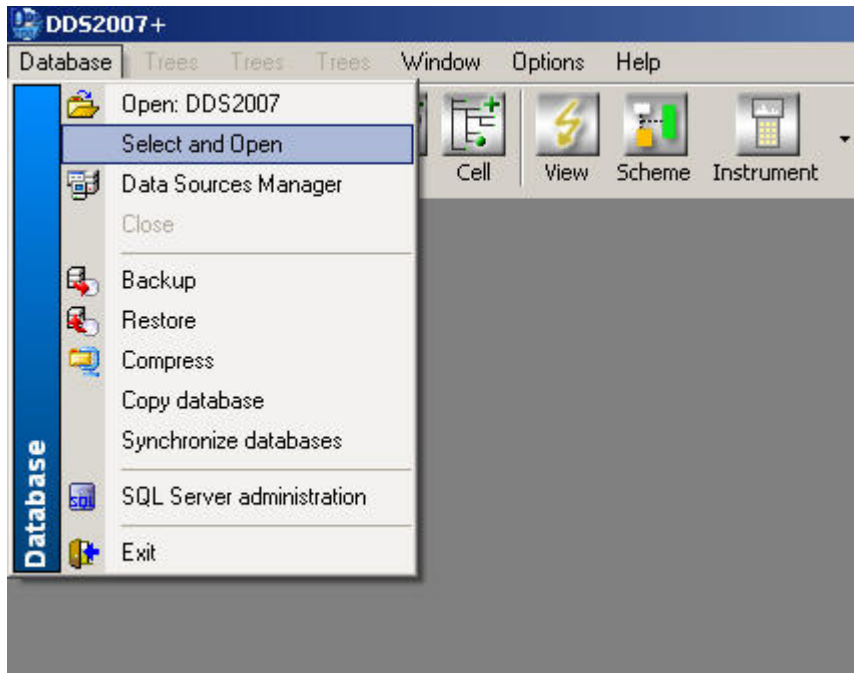

Select the Template DB from it, designated in this case **DEMO_MMS_template** (see filled in editor dialog window above), confirm its opening by clicking on **Open database**.

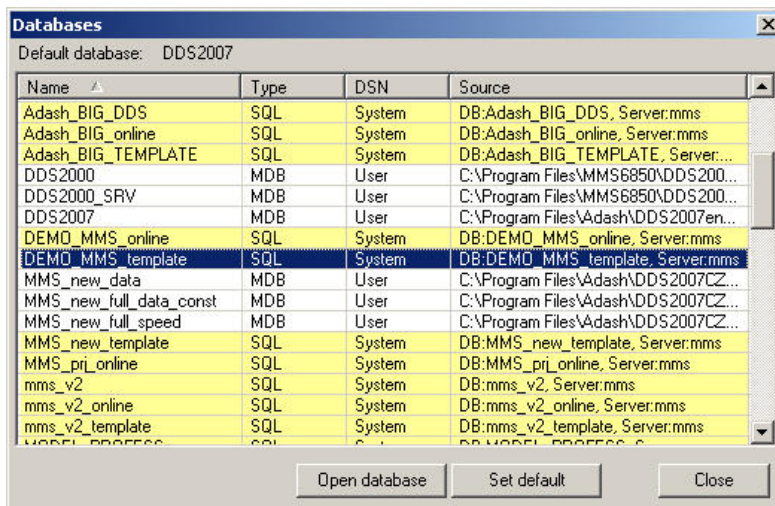

You will see the closed database tree with one item **Root** only.

Expanding of Database Tree

Double-clicking the **Root** item expands the database tree and its data cells appear.

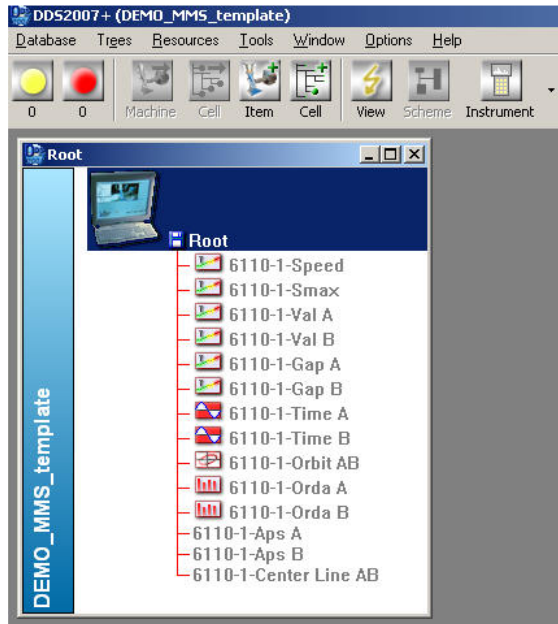

Creation of 6110-1 Item

Click on **Root** and then press **Insert** on the keyboard. You will see the dialog window for creation of new item. Fill in required fields and click **OK**.

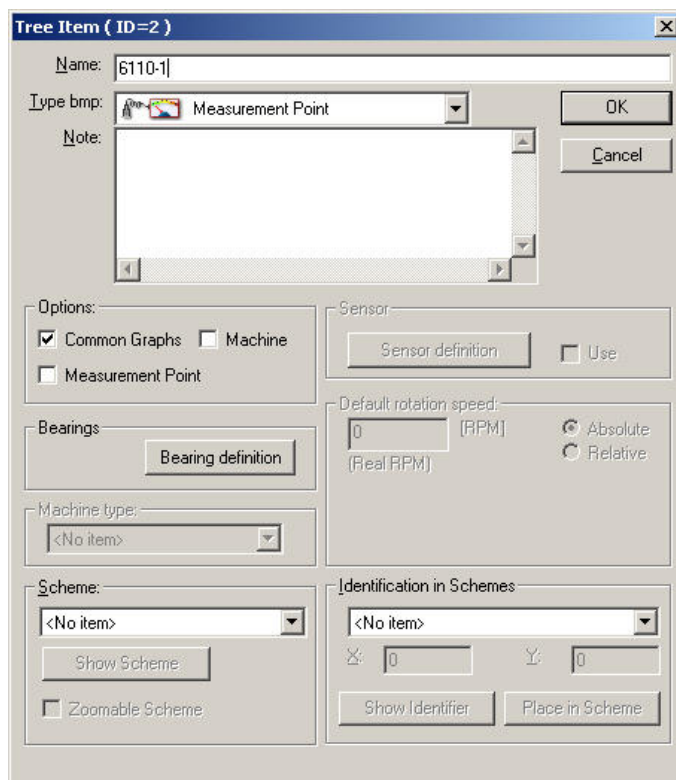

The new created item was added to the database tree.

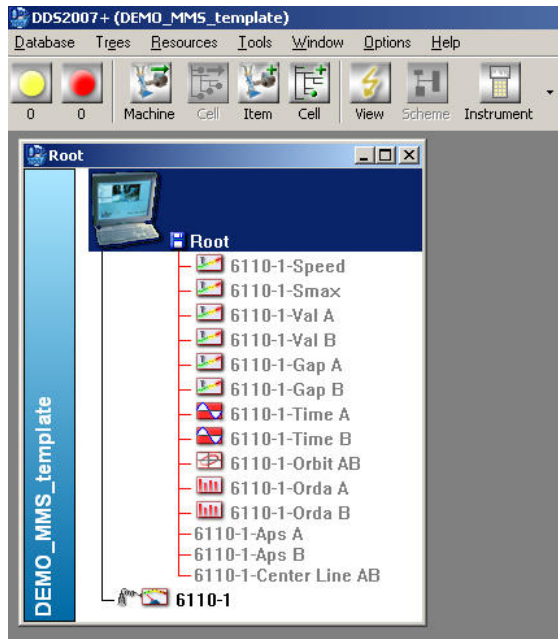

Creation of Common, Channel A and Channel B Items

Click on **6110-1** and then press **Insert** on the keyboard. We shall see the familiar dialog window for creation of the new item again. Create all items the same way as you created the **6110-1** during the last step.

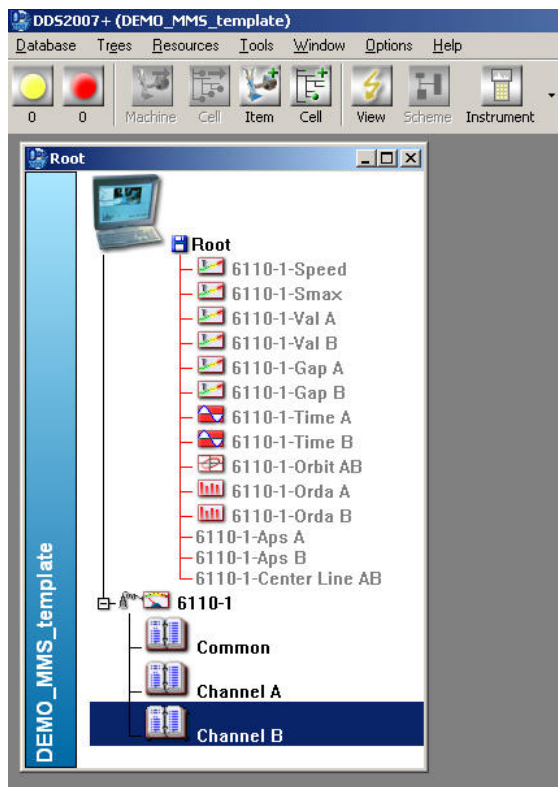

Moving of Selected Data Cells

The Speed, Smax, Orbit AB and Centre Line AB data cells should be moved from the **Root** to the **Common** item.

Click on the first selected item (in this case Speed). Press **Ctrl** on the keyboard and keep it pressed. Add other items by clicking on them.

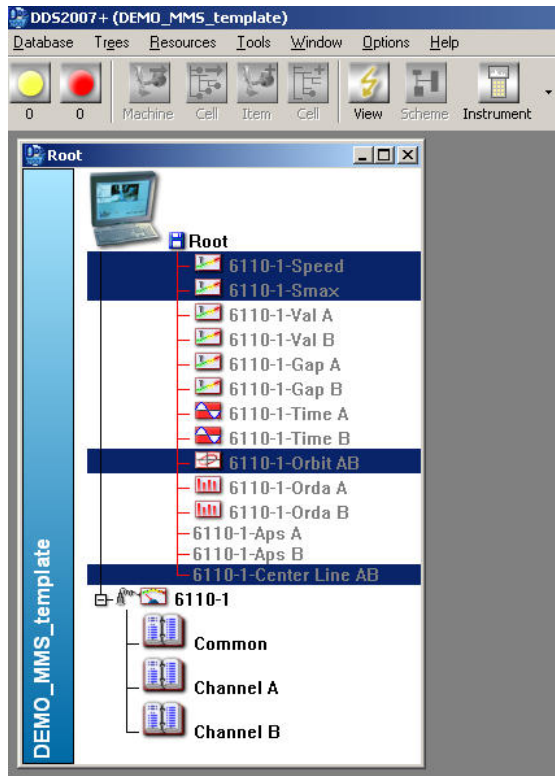

After selecting all items release **Ctrl**. Press **Ctrl** and **X** together, this combination is known from other software. **ATTENTION!** In this case the combination **Ctrl X** does not remove cells from the **Root**, it does not cancel their selection either, they are only ready to be moved. Click on the **Common**, into which you want to move the cells. Their selection is cancelled now. The data cells remain in the **Root** item, even after they were deselected.

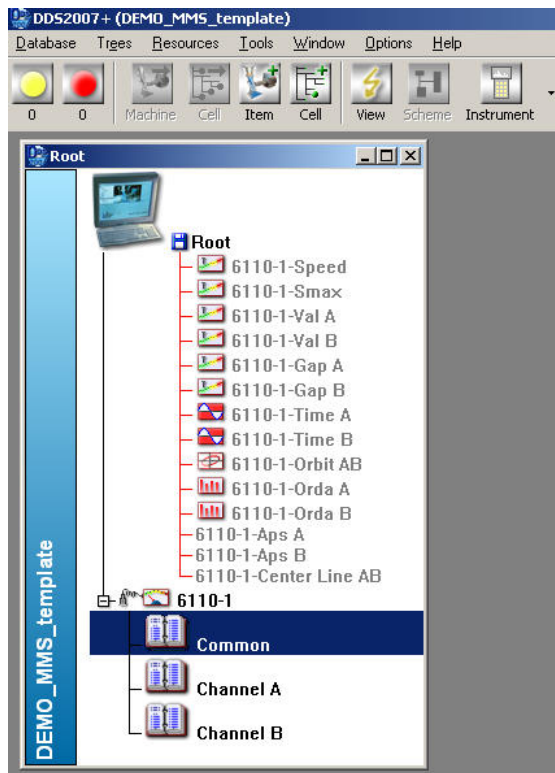

A double combination **Ctrl V** moves the cells from **Root** to a selected item in **Common**.

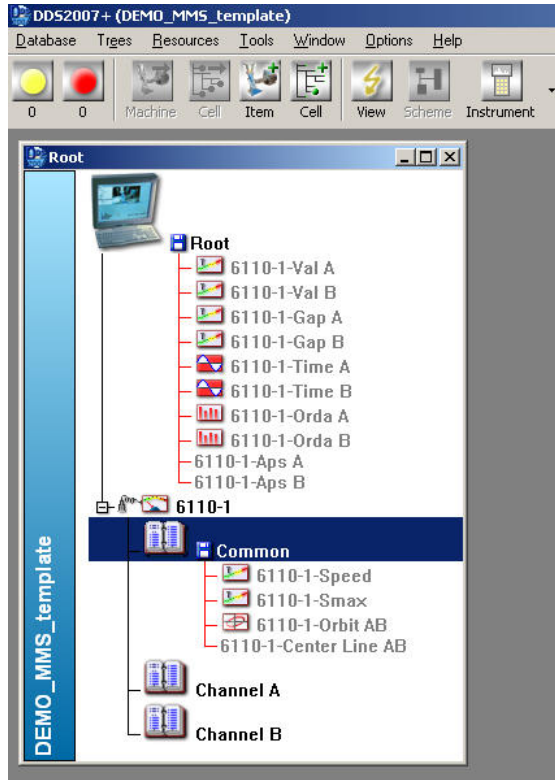

You can move the data cells Val A, Gap A, Time A, Orda A, Aps A into **Channel A** and Val B, Gap B, Time B, Orda B, Aps B into **Channel B** the same way.

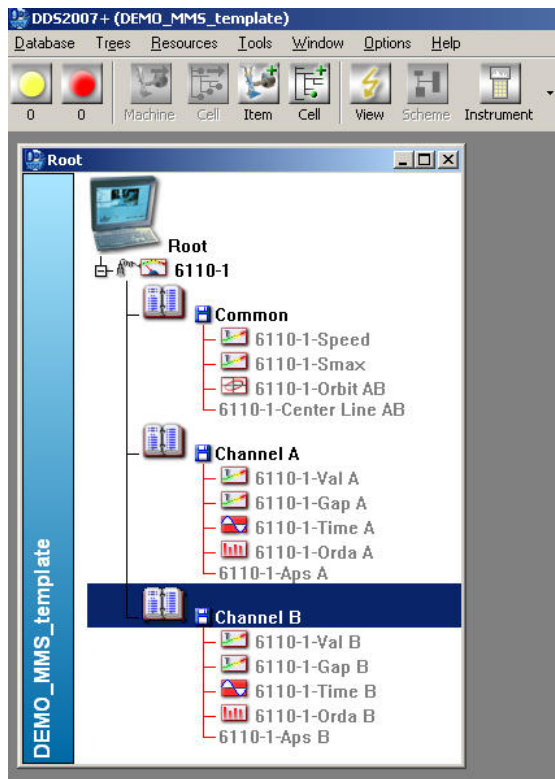

A DDS database template was created by creation, or eventual restructuring of the new Template DB. The **Data Admin** service will create the Normal database for data collection during a normal as well as

abnormal operation of a monitored machine by copying the template, after it is started for the first time. In case of extraordinary situations the **Data Admin** service will create Abnormal databases by copying the same template to collect data during abnormal operations of the monitored machine.

Although the new **adi** configuration file of the **Data Admin** service and the new Template DB were created, the **Data Admin** new project is not complete and therefore it cannot be started. One last step remains - to create a **tcg** definition file and assign measurements to the definitions. How to do it is described in the **TCG Editor** chapter.

Maintenance of Existing adi Configuration File

How to Add New Measurements to Project

The most common modification of the **adi** configuration file is adding new measurements during expansion of a monitoring system.

1. The new measurements had to be added to the **Idi** configuration file of the **Data Loader** service, in order to be transferred by this service from the OPC interface to the Online database (circular memory). How to do it was described in the chapter **Data Loader Project Editor**.
2. Now we need to add these measurements to the **adi** configuration file of the **Data Admin** service, in order to create a database connection between the Online database and the DDS databases template for them. New data cells in the Template DB need to be created for the measurements at the same time. The **Data Admin Project Editor** working in the **Add Cells** mode will take care of it itself.
3. At the end we need to add the measurements to the **tcg** definition file of the **Data Admin** service, in order for this service to start moving them from the Online database to the DDS database. This will be done in the **TCG Editor**.

Procedure of Adding New Measurements to adi Configuration File

When we were creating the new project, we have worked with the 6110-1 card measurements. Now we have to add measurements from the 6120-1 card to a **Data Loader** service project. This step is not described in this manual, however, it is the same as in creation of the new **Idi** configuration file of the **Data Loader** service. Now the new measurements need to be added to the **adi** configuration file of the **Data Admin** service and concurrently to the Template DB.

1. First you can change the parameter value of the **Online History** if it is not suitable.
2. Click on **Save and Finish**. If new measurements are found in the **Idi** configuration file, the editor will create data cells for them in the Template DB and will add their database connections to the **adi** configuration file. Finding of new measurements is announced by this information:

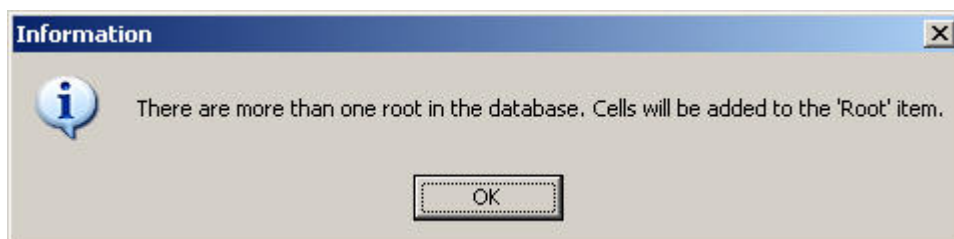

This information is a consequence of restructuring of the Template DB database tree, which we have performed after creation of the new Template DB. If the tree was left in the original state as the mere list of data cells in the root of the database tree, this information would not be written. Since we have created the new branch **6110-1** in the restructuring, the editor informs us that the new data cells can be found in the **Root** item.

3. Confirm this information and the new information about the first found new measurement will be written.

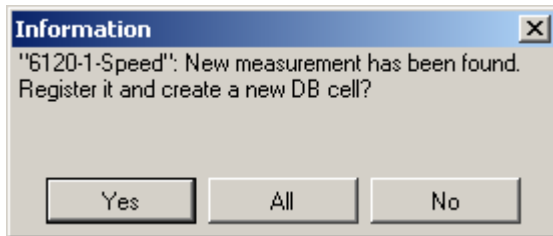

The new speed measurement was found first. There is no database cell in the Template DB, nor database connection in the **adi** configuration file for it (the measurement is not "registered"). By the **Yes** and **No** buttons you can select, which measurements will be added. Clicking on **All** adds all the newly found measurements together.

ATTENTION! If you do not add one of the measurements and then do not remove it from a **Data Loader** service sub-project, the measurement data will accumulate in the Online DB with all negative consequences, which were described before.

4. Clicking on **All** adds all the newly found measurements together. Then the information about the number of the added measurements will be written. (Speed, Val A, Val B, Time A, Time B, Orbit AB, Orda A, Orda B, Aps A, Aps B).



5. Confirm the information. Now the new measurements are added in the **adi** configuration file and the root of the Template DB database tree. If you do not like this database tree arrangement, start the **DDS** and perform restructuring of the tree according to your image. How to do it was already described above during creation of the new **adi** file.

Restructuring of Template DB Database Tree

The **Data Admin Project Editor** created new data cells in a database tree root called **Root**. If you want to move them to different tree branches, you need to do it by the **DDS** software. A detailed methodology of creation of database tree branches and moving of data cells was described step by step in the chapter of the same name earlier, during restructuring of the newly created Template DB. Now we will consider only differences.

We will start from the database tree Template DB that we restructured immediately after creation of the new template. We have added another root to this tree called **6110-1**, into which we moved all the 6110 card measurements from the **Root** item. These measurements were added to the **Root** automatically by the **Data Admin Project Editor** during creation of the new **adi** configuration file. Now we are in the phase, when we have added the new measurements from the 6120 card to the project through the **Data Admin Project Editor**, and the editor automatically created data cells for them in the **Root** item. We shall create a new branch called **6120-1** and divide the measurements in it,

according to the measurement channels, into **Common**, **Channel A** and **Channel B** branches, just like before with the **6110-1**.

Opening of Template DB and Creation of New Items

We will open the database and create the new items in it by the same procedure, which was described before for the **6110-1** branch.

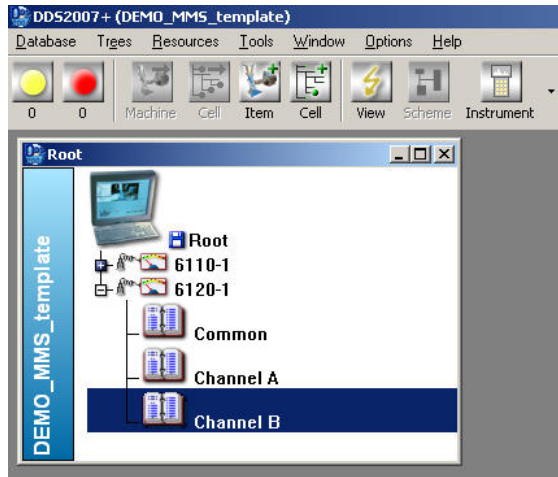

Expanding of Database Tree

Since the **Root** item is not the only item in the database tree any more, we cannot expanded by the double click like before. Display of the list of newly created data cells can be achieved by two methods:

Method No. 1. Click on **Root** item and then press the * key on the keyboard. This will expand the whole database tree. The tree can also be expanded by clicking the **Root** by right mouse button and selecting **Expand all** from the menu. However, expanding the whole tree is not usually suitable. The newly added data cells in the **Root** item are placed at the beginning of the tree, while items, into which we want to move these cells, are in the bottom part of the tree. The whole expanded tree is soon hard to read.

Method No. 2 - recommended. Click on the **Root** item by the right mouse button and select **Open Data Cells** from the menu. Only the **Root** branch with its data cells is expanded.

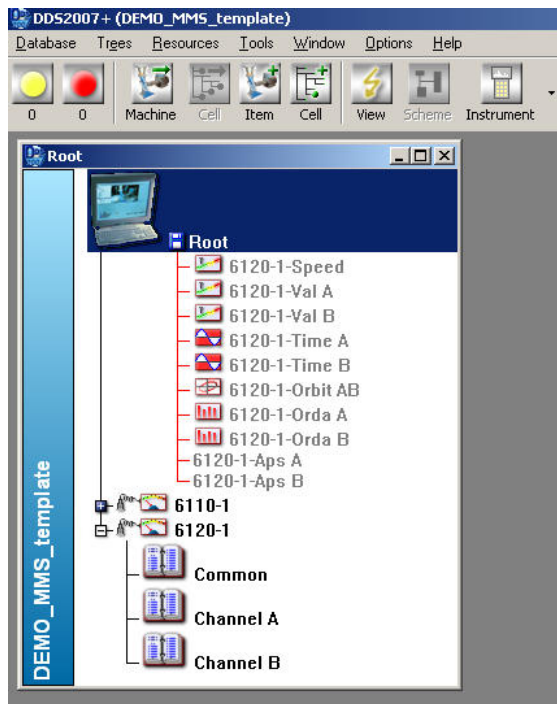

Moving of Data Cells

By using double combinations **Ctrl X** and **Ctrl V** gradually move the data cells in groups from the **Root** item to the **Common**, **Channel A** and **Channel B** items. This procedure was described before during creation of the **6110-1** branch.

TCG Editor

An objective of this software is to let a user create and maintain the **Data Admin** service TCG definition file (with **tcg** extension) easily. This file contains a part of parameter settings needed for the **Data Admin**. It especially contains data reduction definitions and TCG definitions. Remaining parameters are contained in a configuration file (with **adi** extension), for whose creation and maintenance we have the **Data Admin Project Editor**, described in the previous chapter.

Starting of TCG Editor Software

We can start it from the **Data Admin Setup** software, which gives it all necessary parameters and information for further work with a selected project. The main screen can be divided into two parts, left and right.

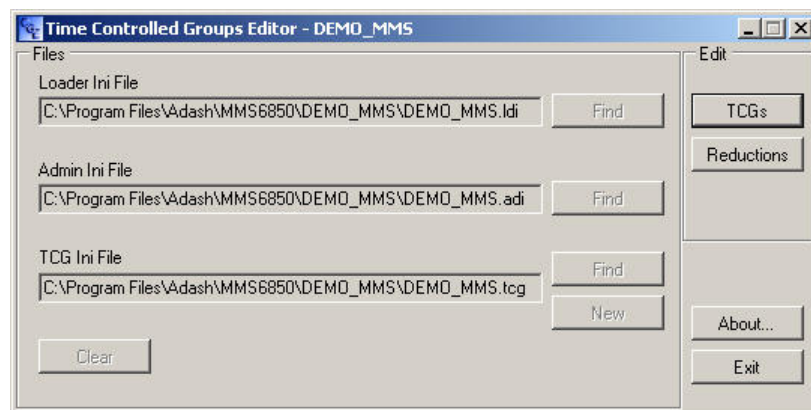

There is the **Files** group at the left side of the window, which serves for selection of project initialization files.

Loader Ini File name of the **Idi** configuration file of the **Data Loader** service. This file is used as an input for the **TCG Editor**. If it does not exist, or if it does not contain any measurement definitions transferred by the **Data Loader** service from the OPC interface to the Online DB, TCGs cannot be created.

Admin Ini File name of the **adi** configuration file of the **Data Admin** service. This file is used as an input for the **TCG Editor**. If it does not exist, or if it does not contain any database connections of measurements transferred by the **Data Admin** service from the Online DB to the DDS database, TCGs cannot be created.

TCG Ini File name of the **tcg** file with TCG definitions and reductions of the **Data Admin** service. This file is an output from the **TCG Editor** software.

Detailed description of individual fields and buttons is shown in the **Level 3**. During normal work with a project, when the editor has been started from the **A3716 Setup** → **Data Admin Setup** software, you do not have to select any files, since the names of all three files are transferred to the editor.

There is the **Edit** group on the right side of the window, whose buttons we use to select, whether we want to create or modify the reductions used by the **Data Admin** service, or if we want to define or modify TCGs.

TCGs after you click on this button, the editor goes into the TCG creation or modification mode.

Reductions after you click on this button, the editor goes into the data reduction definition creation or modification mode.

Exit finishes the software. If the **TCG Editor** was started from the **Data Admin Setup** software, you will return back to the **Data Admin Setup** dialog window.

Creation of First New Reduction

If you do not require to use reductions in your work with the **Data Admin** service, you can skip this chapter over. However, usually it helps to use the reductions, in order for the DDS databases (especially the Normal DB) not to increase too much.

If you are going to use any reductions in the TCG definitions, then you need to create definitions of these reductions before their first assignment to TCG. That is why the chapter on definition creation precedes the chapter on creation of TCGs.

By clicking on **Reductions** in the main editor window, you will switch the editor into a mode of creation of new reductions and modification of parameters of already existing reductions.

The left side of the window has a list of reductions defined up to this point.

Parameters of a selected reduction are shown in the right side of the window.

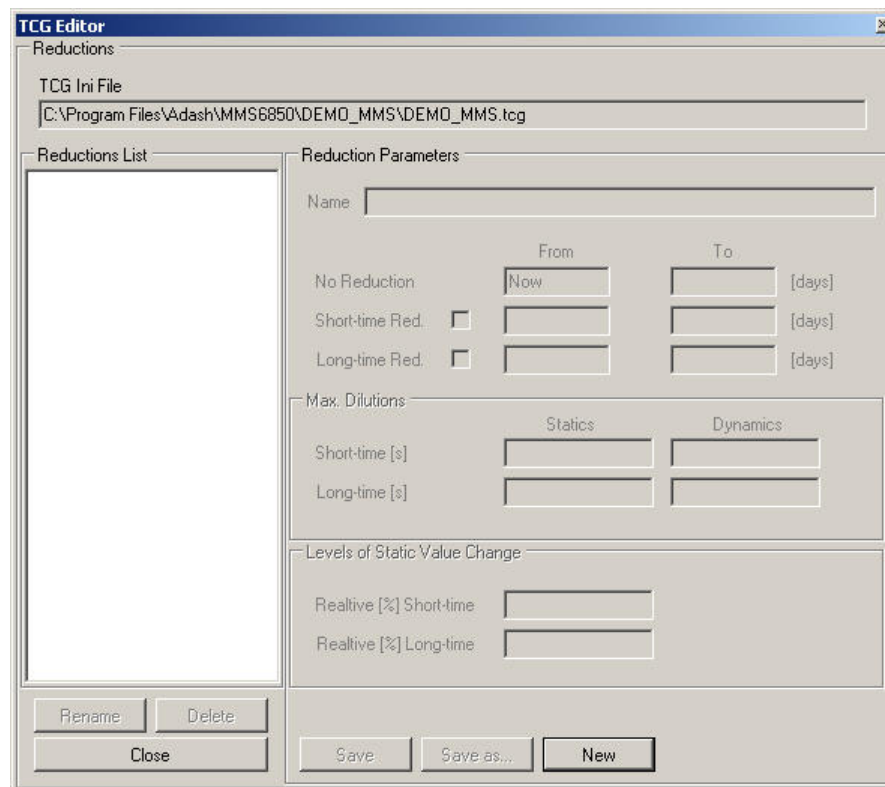

Clicking **New** invokes the dialog to enter a reduction name. A new reduction will be put into the list and assigned to the TCG definitions under this name.



The entered name must not exist in the list already, and it is not possible to enter the reserved name *No_Reduction*. Enter the name of the reduction, and confirm it by **OK**. The new reduction will appear in the **Reductions List**. All the fields for entering parameters will be enabled, and some of them will get filled by predefined values.

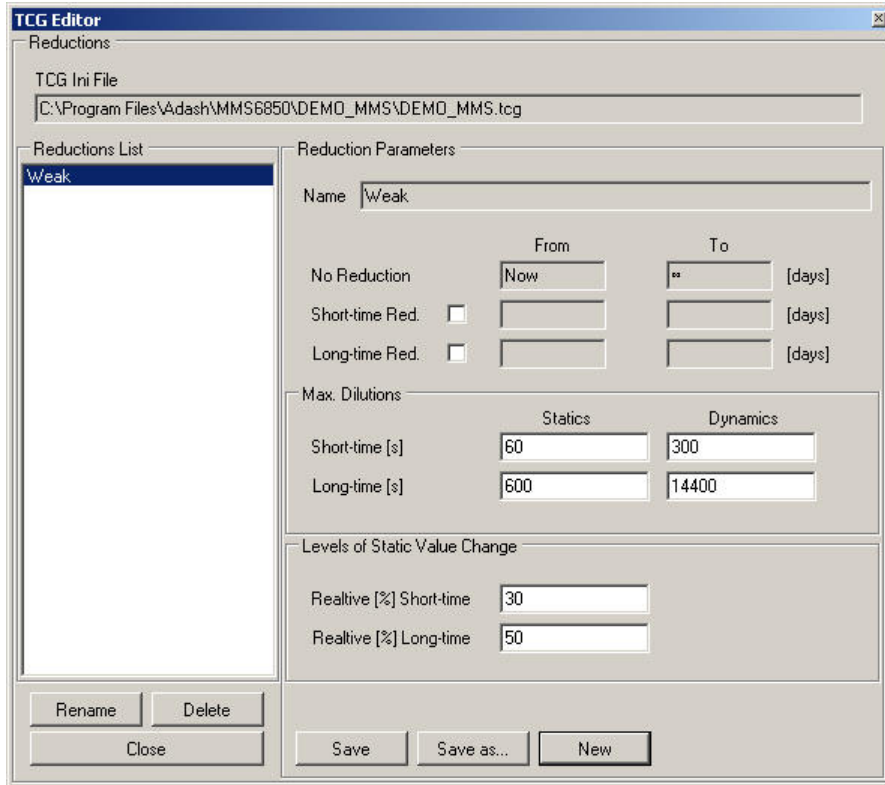

Reduction Intervals

From a data reduction viewpoint there are three time intervals:

1. **No reduction.** New data do not get reduced for a defined period at all. Access to the unreduced data is assured for the period, which enables their detailed analysis in case of occurrence of an extraordinary situation. This interval exists in each reduction.
2. **Short-time reduction.** It partially reduces measured data in order to decrease their volume, however, it would still remain possible to follow development trends and perform analysis on the medium time data. This interval does not have to be defined for a reduction.
3. **Long-time reduction.** Significantly reduces measured data and significantly decreases their volume. This interval does not have to be defined for a reduction.

Each reduction always has an interval of the last stored data without reduction. It is possible to switch on the short-time reduction, long-time reduction, or both (the most common case) for older data. The intervals are defined in days by entering values into **To** fields, as is shown on the following pictures.

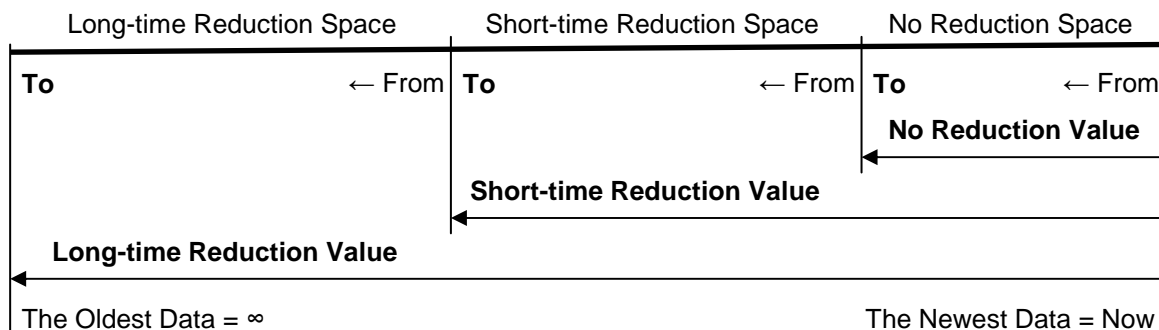

Short-time Reduction Only

Check the **Short-time Red.** field. The **To** field gets enabled for entering the No Reduction interval end, which is also the beginning of the **From** interval of the Short-time Reduction. The **To** field that defines the end of the short-time reduction will stay disabled, since the short-time reduction will be applied all the way to the oldest data ∞ .

The picture shows a situation, when there is no reduction of data for 7 days. All the data older than 7 days are reduced according to parameters of the short-time reduction. The long-time reduction will not be applied to any data.

		From	To	
No Reduction		Now	7	[days]
Short-time Red.	<input checked="" type="checkbox"/>	7	∞	[days]
Long-time Red.	<input type="checkbox"/>			[days]

Long-time Reduction Only

Check the **Long-time Red.** field. The **To** field gets enabled for entering the No Reduction interval end, which is also the beginning of the **From** interval of the Long-time Reduction. The **To** field that defines the end of the long-time reduction will stay disabled, since the long-time reduction will be applied all the way to the oldest data ∞ .

The picture shows a situation, when there is no reduction of data for 15 days. All the data older than 15 days are reduced according to parameters of the long-time reduction. The short-time reduction will not be applied to any data.

		From	To	
No Reduction		Now	15	[days]
Short-time Red.	<input type="checkbox"/>			[days]
Long-time Red.	<input checked="" type="checkbox"/>	15	∞	[days]

Short-time and Long-time Reductions

Check the **Short-time Red.** field. The **To** field gets enabled for entering the No Reduction interval end, which is also the beginning of the **From** interval of the Short-time Reduction. Now check the **Long-time Red.** field. The **To** field gets enabled for entering the Short-time Reduction interval end, which is also the beginning of the **From** interval of the Long-time Reduction.

The picture shows a situation, when there is no reduction of data for 30 days. All data older than 30 days, but not older than 90 days are reduced according to parameters of the short-time reduction. All the data older than 90 days are reduced according to parameters of the long-time reduction.

		From	To	
No Reduction		Now	30	[days]
Short-time Red.	<input checked="" type="checkbox"/>	30	90	[days]
Long-time Red.	<input checked="" type="checkbox"/>	90	∞	[days]

Max. Dilution - Parameter of Data Dilution

A data reduction in its final result presents “dilution” of the succession of the originally more often measured and stored data. In no case, however, it is just mere time dilution, which could cause that significant data, which by accident fell into a dilution interval, would be removed or lost. That is why also other parameters exist, from the time dilution point of view, that qualify a possibility of removal of a measured value from the data succession as a consequence of the reduction.

In a simple case it would be sufficient to define the interval, which should remain in the data after the reduction, and all the data within this interval would be removed. However, with regard to other criteria limiting the possibility to remove any data within this time interval, we cannot require keeping of the identical interval between the reduced data. For example if all the data inside of the just reduced interval are significant, then the reduction algorithm must keep all of them. Such data interval must then stay the same even after the reduction. From the time point of view we can only order a **maximum** interval that can stay in the data after the reduction. Thus defined interval among the data kept after the reduction is requested for two reasons:

1. The significant data inside of the reduced interval cannot be removed and will stay available for further analysis even after the reduction. In this case the reduced data will be more dense inside of this interval than in the interval with the “unimportant” data.
2. During stable operation, when the data stay practically the same for hours or even days, and consequently “unimportant”, the interval between them will be the requested maximum interval after the reduction. This signals that no data are lost, for example, as a consequence of a monitoring system outage, but are only strongly diluted as a consequence of the monitored equipment stable run.

The picture shows a situation, where in the section **Significant Data** almost all the data after reduction remained. On the contrary in the section **Insignificant Data**, there are three values of “uninteresting” data remaining only to maintain the Max. Dilution parameter

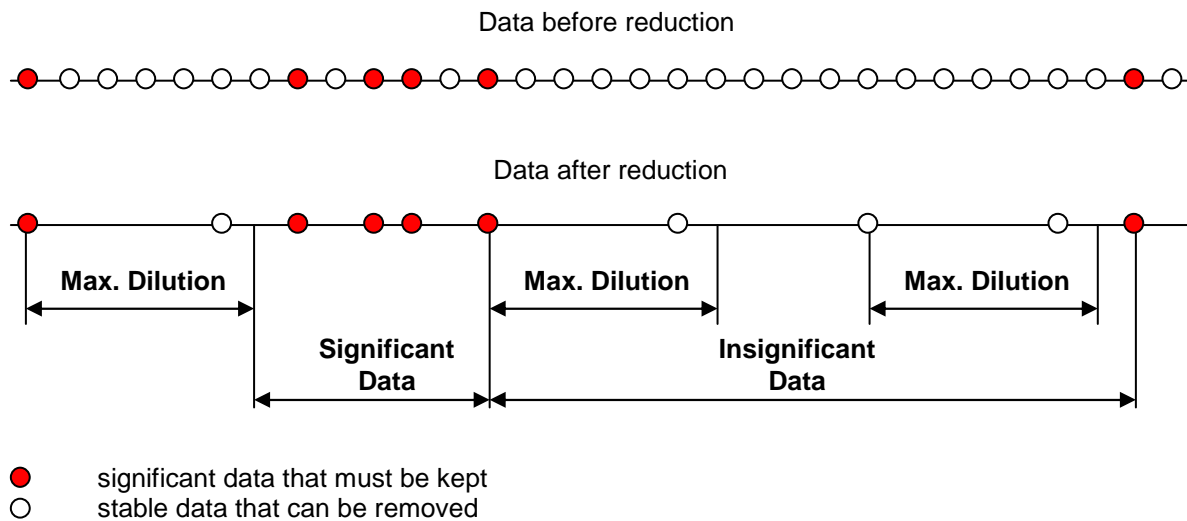

Set the max. requested data interval after reduction in the **Max. Dilutions** group. This interval is entered in seconds and is different for long-tome or short-time reductions, and also usually for static or dynamic measurements.

We normally select smaller level of data reduction, i.e. shorter interval for the short-time reduction than for the long-time one. On the other hand we usually dilute dynamic data far more than static ones.

Max. Dilutions			
	Statics	Dynamics	
Short-time [s]	<input type="text" value="60"/>	<input type="text" value="300"/>	
Long-time [s]	<input type="text" value="600"/>	<input type="text" value="14400"/>	

The picture shows a situation, where we want the interval between measurements no smaller than 1 minute (60 seconds) for static data after short-time reduction, while for long-time reduction we are satisfied with 10 minutes (600 seconds). We select larger intervals for dynamic data. We request the interval after short-time reduction at least 5 minutes (300 seconds), after the long-time reduction we are satisfied with the interval of 4 hours (14400 seconds).

Significant Change of Static Data

During the dilution of static data the significance of the measured data beyond the time view must also be applied. If we did not introduce this parameter, we would be removing important data for possible further analysis during the data dilution. The important indicator of the static data significance is an amplitude of the measured value. There are three types of amplitudes:

- absolute,
- relative with regard to some reference value,
- **relative with regard to a previous value remaining after reduction.**

If we have a chance to assign a reduction to each measurement, then we can apply all three views to the measured value. However, this is not our case. With the A3750 monitoring system we **assign a reduction to the whole TCG**. And we can introduce measurements of different quantities into one TCG, i.e. measurements, whose results are in different units. We would be hard put to define an absolute limit, which would satisfy measurements of acceleration, velocity, displacement and speed at the same time. We would have the same problem if the limit would be defined relative to some reference value.

Only if we define the limit relative to the previous value left after a reduction, we can find an agreement, unless we introduce completely incommensurable quantities into one TCG. For example, if a change of the monitored equipment speed is significant in the amount of 5%, and significant change of vibrations is significant at 30%, then it is not suitable to apply the same reduction to the both sets of data.

Relative Change

We can understand the relative change of 30% of the 1500 RPM measured value in two ways:

1. the change of $\pm 30\%$, which corresponds to $0.7 \cdot 1500 = 1050$ RPM and $1.3 \cdot 1500 = 1950$ RPM,
2. **the change to $1 / 1.3 = 1154$ RPM and to $1.3 \cdot 1500 = 1950$ RPM.**

We are not going to analyse the reasons, which led to the refusal of the first interpretation, in detail here. The **Data Admin** service uses the second interpretation. The dependency of the upper and lower values on a selection of the % is shown on the following graph and the table. (Please note that you can enter values higher than 100% and more. This would not be possible with the first interpretation.)

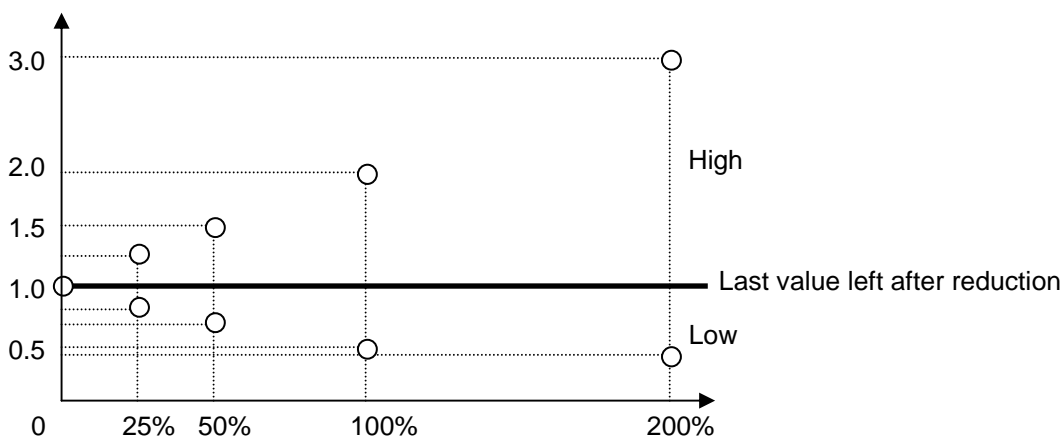

%	10	15	20	25	30	40	50	60	70	80	90	100	150	200
High	1.10	1.15	1.20	1.25	1.30	1.40	1.50	1.60	1.70	1.80	1.90	2.00	2.50	3.00
Low	0.91	0.87	0.83	0.80	0.77	0.71	0.67	0.63	0.59	0.56	0.53	0.50	0.40	0.33

Levels of Static Value Change	
Relative [%] Short-time	<input type="text" value="20"/>
Relative [%] Long-time	<input type="text" value="40"/>

This picture shows the situation, where we require:

- to keep static data after short-time reduction, whose values exceed by 1.2 times, or decrease under $1 / 1.2 = 0.83$ times the value of the last remaining value after the reduction,
- to keep static data after long-time reduction, whose values exceed by 1.4 times, or decrease under $1 / 1.4 = 0.71$ times the value of the last remaining value after the reduction.

Storing Reduction in tcg File

The reduction definition is now complete, and by clicking on **Save** it can be stored in the **tcg** file. Further reductions are defined and stored the same way. Finally, clicking **Close** closes the window for reduction work, and you will return back to the main editor window.

The screenshot shows the TCG Editor window with the following configuration:

- TCG Ini File:** C:\Program Files\Adash\MMS6850\DEMO_MMS\DEMO_MMS.tcg
- Reductions List:** Weak
- Reduction Parameters:**
 - Name: Weak
 - From: Now, To: 30 [days]
 - Short-time Red. 30, 90 [days]
 - Long-time Red. 90, ∞ [days]
- Max. Dilutions:**
 - Short-time [s]: Statics 60, Dynamics 300
 - Long-time [s]: Statics 600, Dynamics 14400
- Levels of Static Value Change:**
 - Relative [%] Short-time: 20
 - Relative [%] Long-time: 40

Buttons at the bottom: Rename, Delete, Close, Save, Save as..., New.

Creation of Another Reduction

The procedure from the last chapter **Creation of First New Reduction** can be, of course, used during creation of further reductions. However, what often happens, is that the reduction that is being newly created is very similar to an already existing reduction. We would like to take advantage of this by copying of this reduction and changing some of its parameters. The editor enables such procedure,

and we will demonstrate it on creation of the new reduction called **Usual**. Let us assume that it only differs from the already existing reduction Weak by the **Max. Dilutions** parameters.

By clicking on **Reductions** in the main editor window, you will switch the editor into a mode of creation of new reductions and modification of parameters of already existing reductions. If the reduction list consists of more items, click on a name of the reduction, which is the most similar to the reduction you want to create. You can check its parameters in the right half of the window. In our case there is only one item on the list with the name **Weak**.

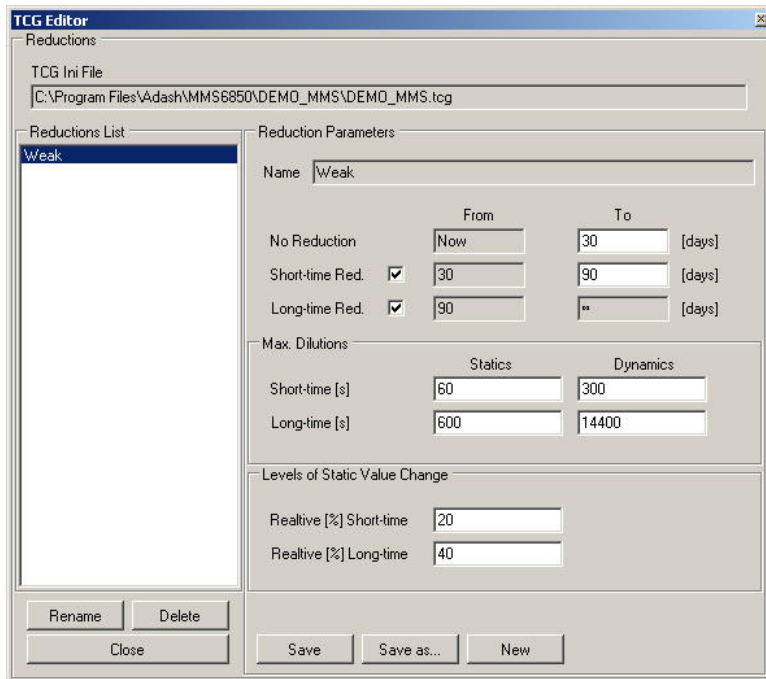

Click on **Save as...** and the dialog to enter the new reduction name will open. You are already familiar with the dialog from the previous chapter **Creation of First New Reduction**. Enter the name **Usual** and confirm it by **OK**. The copy of the selected reduction will be placed to the end of the list under the entered name.

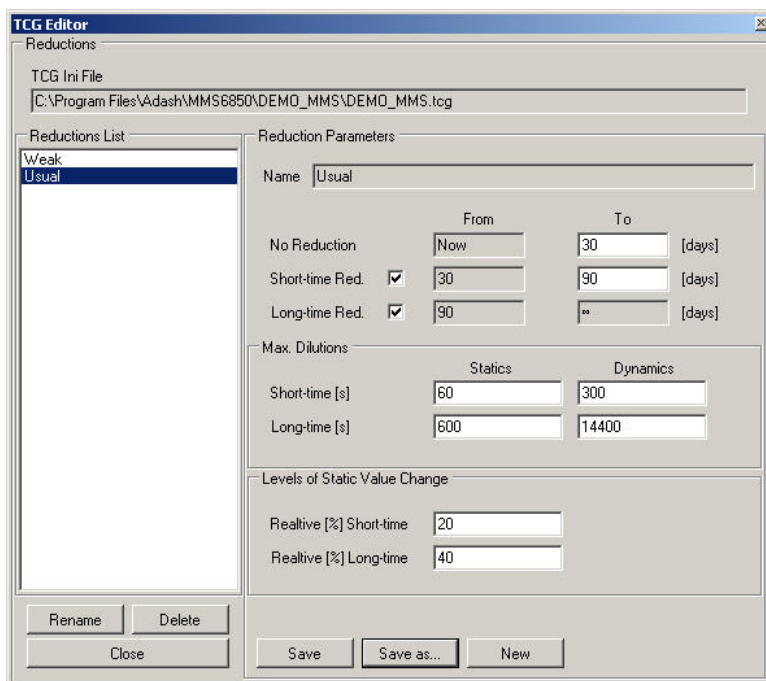

Now modify parameters **Max. Dilutions**, and save the new reduction into the **tcg** file by clicking on **Save**.

Change of Reduction Parameters

If you change parameters of any reduction, you will be able to see the changes only after restart of the Data Admin service, which will read in the **tcg** file with new parameters after starting.

By clicking on **Reductions** in the main editor window, you will switch the editor into a mode of creation of new reductions and modification of parameters of already existing reductions. In the chapter **Creation of First New Reduction**, we have become familiar with all reduction parameters and with important elements of the window for work with reductions. It is assumed in the further text that you are capable of creating a new reduction. Now we will demonstrate, what parameter changes are offered by the editor.

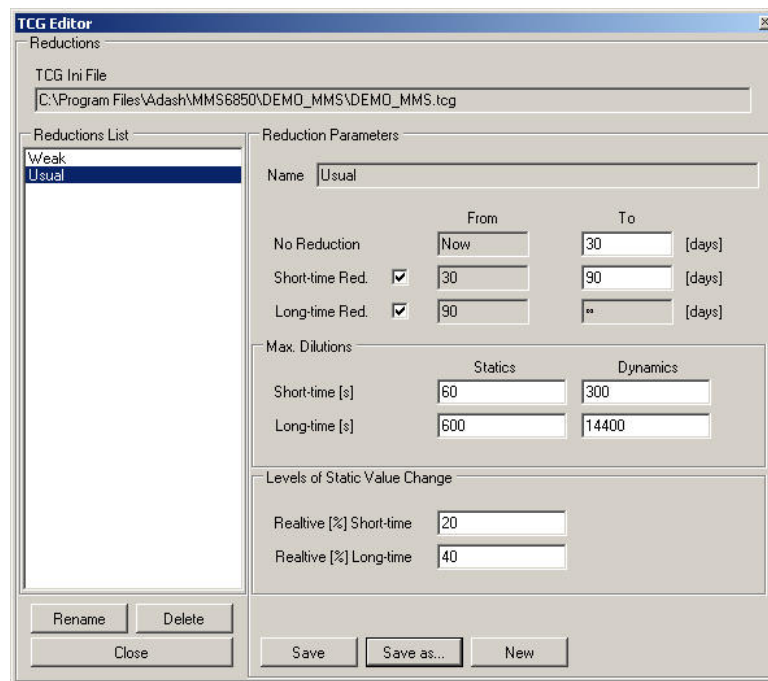

Any parameter shown in the right half of the **Reduction Parameters** window can be changed by the following procedure:

- Perform the change of one or more parameters by overwriting the value in the appropriate field.
- Click on **Save** to store the changes into the **tcg** file.

Change of Reduction Name

Each reduction must have its own name, which unambiguously identifies it in two cases.

1. The reduction is shown under its own name in the editor reduction work window, in the window part called **Reduction List**. Renaming of the reduction does not have any side effects with regard to the **Reduction List**.

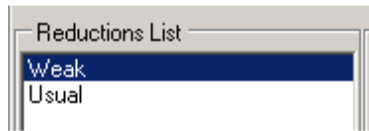

2. The reduction is being selected from the list of defined reductions in case of its assignment to TCG. The assignment is done in the editor window for work with TCGs, in the part called **TCG Parameters – Reduction**. If you rename any reduction, **do not forget to assign the new name to all TCGs**, which used this reduction before. If you leave it the original name, which does not exist anymore, the **Data Admin** service will not perform any data reduction.

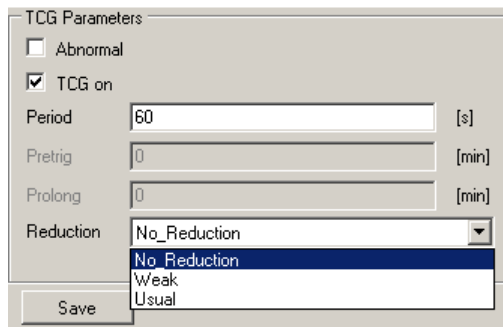

Reduction renaming is done as follows:

- In the **Reductions List** click on the name of the reduction you want to rename.
- Click on **Rename**. The dialog to enter a new name appears.
- Enter the new reduction name, which may not be contained in the **Reductions List** already, and confirm it with **OK**.
- A new reduction will appear in the **Reductions List** with the new name.
- Click on **Save** to store the changes into the **tcg** file.

Creation of First New Normal TCG

If the **tcg** file does not have any TCGs defined, a project is not complete, and it does not make sense to start it. In order to transfer any measurement data from the OPC interface all the way to the DDS database, this measurement must fulfil three conditions:

1. A definition of this measurement must be performed in the **Idi** configuration file of the **Data Loader** service. It will ensure that the **Data Loader** service will transfer data from the OPC interface to the Online database. We have learned, how to create the needed definition in the chapter **Data Loader Project Editor**.
2. A new data cell must be created in the Template DB for the measurement. This will ensure that the **Data Admin** service will be capable of creation of the corresponding data cell in both DDS databases (in Normal DB and in Abnormal DB). After this the database connection between the Online DB and DDS DB will have to be added into the **adi** configuration file of the **Data Admin** service for this measurement. This will ensure that the **Data Admin** service will know, from which Online database data cell to which DDS database data cell it should transfer the data. We have learned, how to create the corresponding data cell in the Template DB and its database connection in the chapter **Data Admin Project Editor**.
3. The measurement must be entered at least into one active TCG definition in the **tcg** definition set for the **Data Admin** service. The **Data Admin** service creates a measurement table from the TCG definitions, whose data it transfers from the Online database to the DDS database. We will learn how to create the TCG definition, and how to include requested measurements in it in this chapter.

By clicking on **TCGs** in the main editor window, you will switch the editor into a mode of creation of new TCGs and modification of parameters of already existing ones.

The upper left quarter of the window has a list of TCGs defined up to this point.

Parameters of the selected TCG are shown in the individual fields in the left bottom quarter.

A list of measurements included into TCG is in the upper right quarter.

A list of control measurements included into TCG is in the bottom right quarter. This list is available only for Abnormal TCG. Normal TCG does not have any control measurements defined.

Task

We will create Normal TCG in the further text that we will call 6110-1 Normal Static. We will include the static measurements from the 6110-1 card in it. They will be Speed, Smax, Val A, Val B, Gap A and Gap B. We require a one minute measurement period, and we will apply the reduction Weak, which we have created in the previous chapter, on the data.

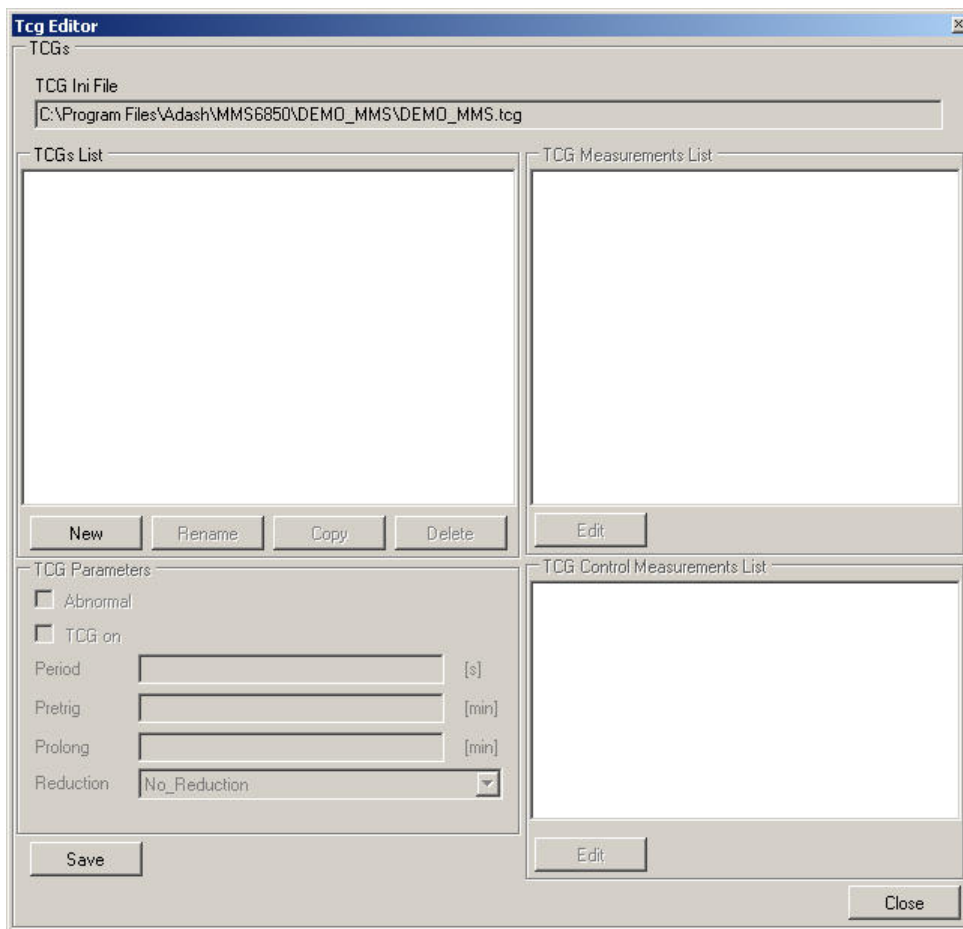

Clicking **New** invokes the dialog to enter a new TCG name.



Enter the requested name 6110-1 Normal Static and confirm it with **OK**. The new TCG will appear in the list and its parameters will be set to predefined values (TCG type Normal, active, with 60 second period, and with no reduction applied to data). From the **Reductions** offer pick the requested reduction Weak, which enters all the Normal TCG parameters.

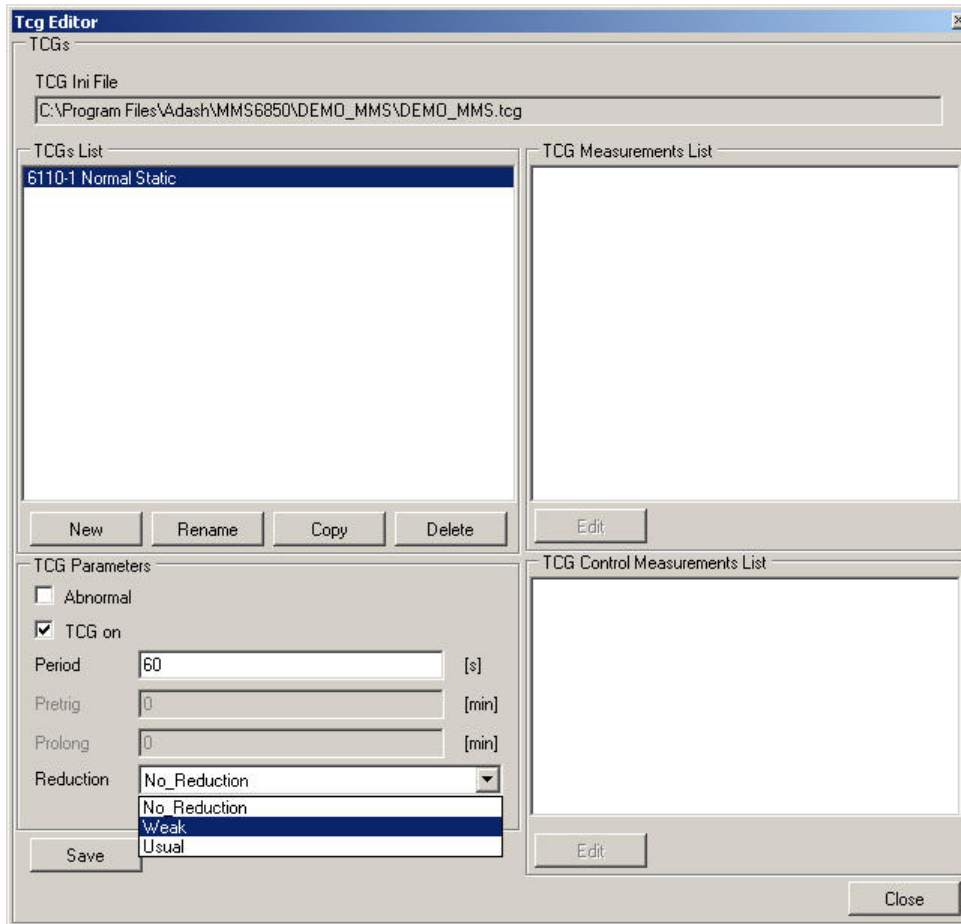

In order to have complete Normal TCG definition, we need to add required measurements into the **TCG Measurements List**. However the button **Edit** of this list is disabled. If the **Edit** of any of the lists is disabled, it means that TCG parameters were changed, but they were not stored into **tcg** files by **Save**. Click on **Save** and this will enable **Edit** for the **TCG Measurements List**. **Edit** for the **TCG Control Measurements List** will stay disabled, since we are creating a Normal TCG. Click on **Edit** and this will open a window to edit the **TCG Measurements List**.

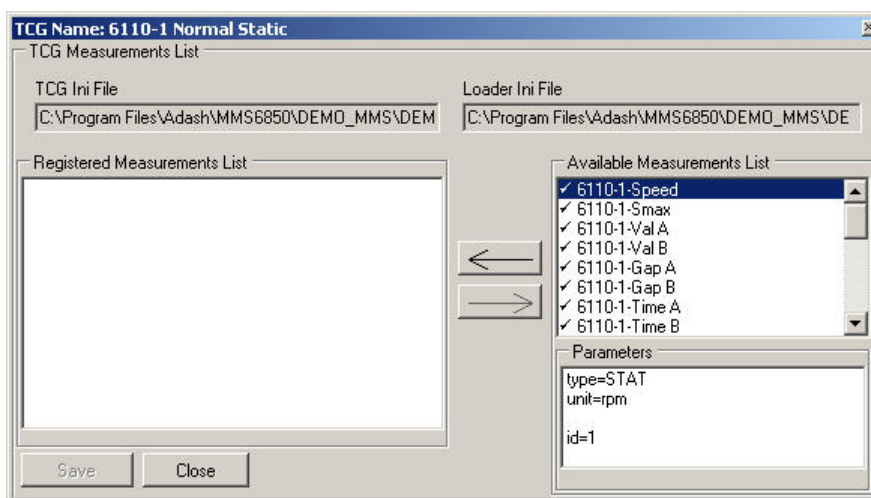

The left half of the window shows a list of measurements included in TCG. It is marked as **Registered Measurements List**. In our case it is yet empty.

The right half of the window has the list of all available measurements, which can be added into the TCG. It is marked as the **Available Measurements List**. Items that have the \checkmark mark in front of them, have the status_on parameter set in the **Idi** configuration file, and are transferred from the OPC interface to the Online database by the **Data Loader** service. The measurements, which do not have this sign on front of their names, are temporarily suspended, but can be added to TCGs. This setting can be changed by editing the **Idi** file only. Clicking on any item from this list activates the selected measurement.

- Parameters of the selected measurement are shown in the window **Parameters**. These are parameters read from the **Idi** configuration file of the **Data Loader** service.

- The selected measurement can be added to the **Registered Measurements List** by clicking on \leftarrow . Multiple choice is possible in the list, and so a whole group of measurements from the **Available Measurements List** can be added to the **Registered Measurements List**. The multiple choice is performed standardly by mouse and **Shift** or **Ctrl** keys.

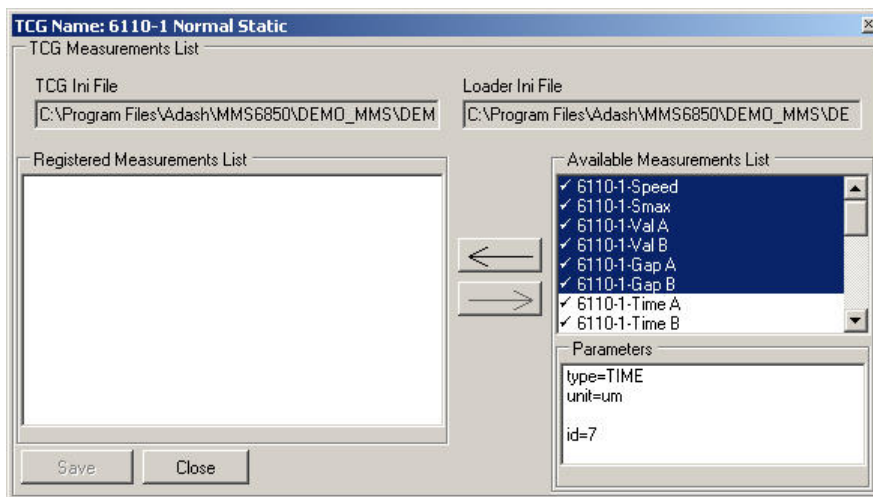

Clicking on \leftarrow transfers all selected measurements from the **Available Measurements List** to the **Registered Measurements List**. The **Save** button is enabled at the same time.

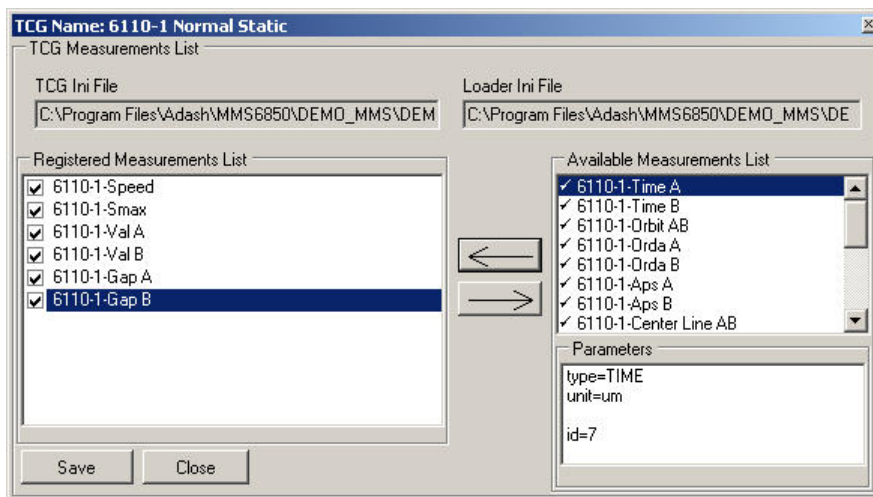

Click on **Save** to store the changes into the **tcg** file. Then close the **TCG Measurements List** edit window by clicking on **Close**, and you will return back to the window for work with TCGs.

All the newly added measurements have the \checkmark in front of their names. This signals that the measurement is not halted in the TCG. **The checking field can be edited in the Registered Measurements List**, and you can suspend any measurement by clicking on it.

ATTENTION! If a measurement is registered in more TCGs, and should be suspended in one or more TCGs, then a suitable place to do it is here. The measurement will stay active in the remaining TCGs,

its data will continue to be transferred by the **Data Admin** service from the Online DB to the DDS DB, so they will not accumulate in the Online DB. However, if the measurement should be suspended as such, then it is better to suspend it through the parameter status in the **Idi** file. In this case the **Data Loader** service will not transfer the suspended measurement data from the OPC interface to the Online DB at all.

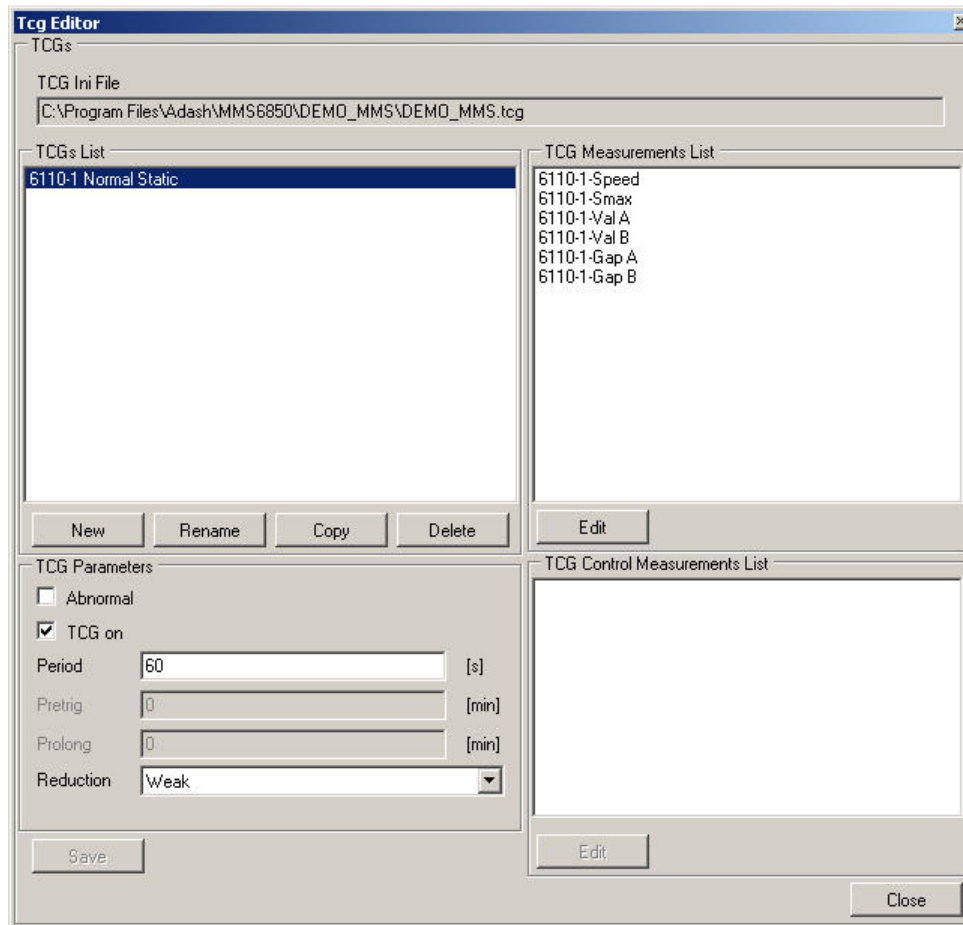

The added measurements are shown in the **TCG Measurements List** window and the definition 6110-1 Normal Static TCG is complete.

Saving of TCG Definition in tcg File

If the **Save** is enabled, click on it. This will store the definition into the **tcg** file. Then click on **Close**. The window for work with TCGs will close, and you will return back to the main window of the **TCG Editor** software.

Creation of First New Abnormal TCG

We have learned how to define the Normal TCG in the previous chapter **Creation of First New Normal TCG**. While the Normal TCG runs continuously, the Abnormal TCG is started by an extraordinary event and finished by an end of one. The beginning and ending of an extraordinary event is evaluated by the **Data Admin** service according to actual status of so called control TCG

quantities (control TCG measurements). For this reason must a Abnormal TCG definition contain at least one item in the **TCG Control Measurements List**.

All active Normal TCGs store the continuously measured data into one Normal DB. This exists all the time, during normal and abnormal operations of a monitored equipment. Similarly all concurrently running Abnormal TCGs store their data into one Abnormal DB. The difference is: While Normal DB exists continuously, the Abnormal DB creates the first starting Abnormal TCG only after the start of an extraordinary situation. All running Abnormal TCGs will store data into this newly created Abnormal DB now. After the extraordinary situation ends, the last finishing Abnormal TCG at its end closes the Abnormal DB used up to this point and casts it aside. The next extraordinary situation invokes creation of another new Abnormal DB and the cycle repeats itself.

Definition of an Abnormal TCG differs from the one of a Normal TCG in these points:

- The **Abnormal** field is checked in the **TCG Parameters** group. This makes the fields **Pretrig** and **Prolong** accessible.
- We can enter how many minutes of data measured before the beginning of an extraordinary event should be stored in this TCG into the **Pretrig** field.
- We can enter how many minutes after the ending of the extraordinary event should the TCG stay active, as if the extraordinary event continued into the **Prolong** field. **This parameter should always be non-zero**. The non-zero **Prolong** parameter will ensure that in case, when a monitored equipment works at the edge of beginning / ending of an extraordinary event, the data will get collected into one Abnormal DB.
- After TCG parameters are saved by clicking on **Save**, both **Edit** buttons get enabled. The enabling of **Edit** for the **TCG Control Measurements List** enables assigning of control measurements of an Abnormal TCG.

Prolong Parameter in Hysteresis Function

The **Prolong** parameter has two functions:

1. It enables to include data measured after the ending of an extraordinary event into an Abnormal DB.
2. Creates hysteresis if a monitored equipment works at the edge of beginning / ending of an extraordinary event.

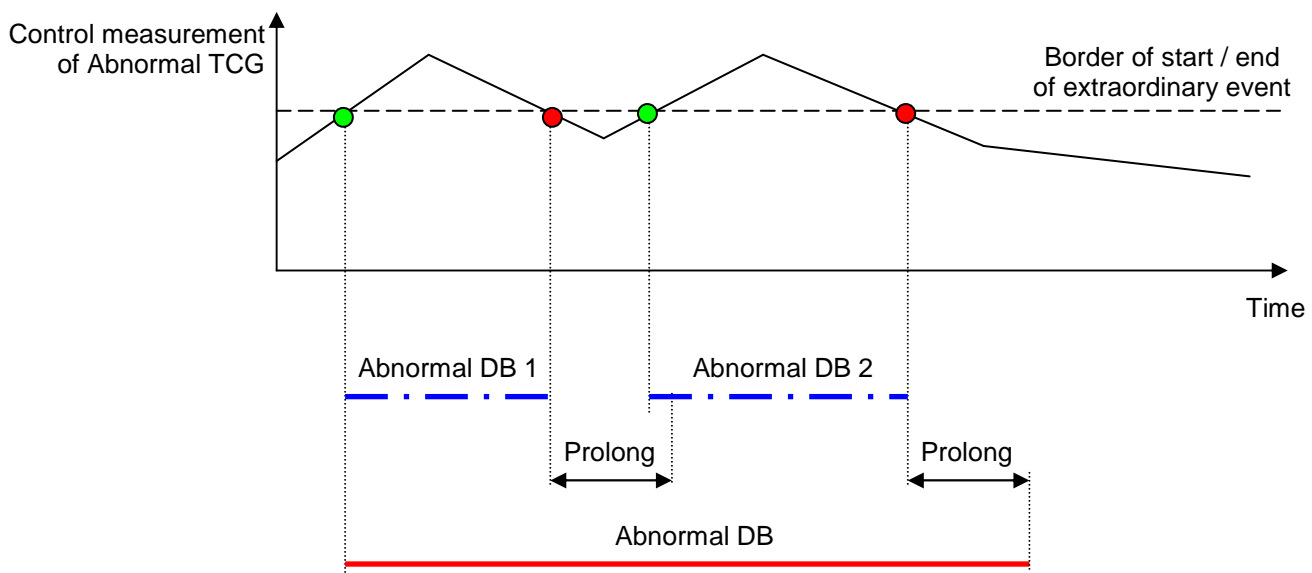

- Start of extraordinary event ● End of extraordinary event

The picture shows a situation, in which during a short time, two extraordinary events began and ended. As a consequence of the parameter **Prolong** being zero, two (blue dot-and-dash line) Abnormal DBs were created, recording data from the individual extraordinary events. On the contrary by choosing of a suitable non-zero **Prolong** parameter, we would create only one (red continuous line) Abnormal DB, which would record data of both extraordinary events.

Task

We are going to create an Abnormal TCG, which we will call 6110-1 Abnormal Static, in the further text. We are going to include all static measurements from the card 6110-1 into it. The measurements will be Speed, Smax, Val A, Val B, Gap A and Gap B. We require a measurement period of 20 seconds, storing of the data measured two minutes before occurrence of an extraordinary event and five minutes after it. We do not want to apply any reduction to the stored data. TCG will be controlled by speed, as the only control quantity. We shall demonstrate later, how we are going to determine the limits for TCG control. When we are creating the Abnormal TCG definition, we assume that you can create a Normal TCG definition, as was shown before.

Entering of Name and Creation of TCG Frame

We could start creating the Abnormal TCG the same way, as we created our first Normal TCG in the previous chapter. Here, however, we are going to take advantage of the fact that the **TCG Measurements List** of the previously created Normal TCG is the same, as the **TCG Measurements List** of the Abnormal TCG that is being created. We are going to copy the already existing Normal TCG, and then modify necessary parameters. At the end we are going to create the **TCG Control Measurements List** to complete the definition.

By clicking on **TCGs** in the main editor window, you are going to switch the editor to the work with TCGs mode. The **TCG List**, with all so far defined TCGs, is located in the upper part of the newly opened window. In our case the list contains only one item with the name 6110-1 Normal Static. If it is not selected, click on it. Then click on **Copy**, and a dialog to enter a name will appear. Fill it with the name 6110-1 Abnormal Static and confirm with **OK**. A new item, created by copying of the original TCG, appears at the end of the **TCG List**. Thanks to this the **TCG Measurements List**, which we inherited from the Normal TCG, is filled for the new Abnormal TCG.

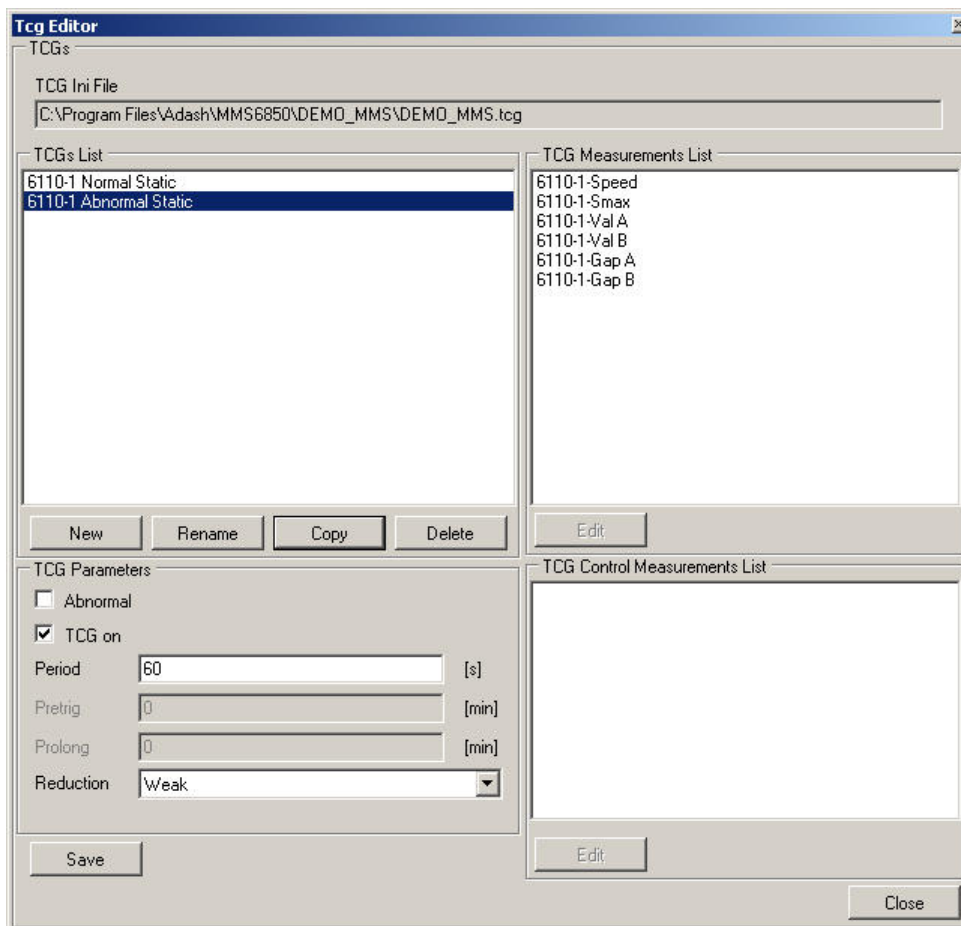

We are going to fix the following items in the **TCG Parameters** group:

- Check the **Abnormal** field. This will make the fields **Pretrig** and **Prolong** accessible.
- Put 20 into **Period**.
- Put 2 into **Pretrig**.
- Put 5 into **Prolong**.
- Change **Reduction** to No_Reduction. Short-time and long-time intervals were given in days in the **Weak** reduction definition. However, periods of extraordinary situation do not last days. If there is a reduction set for the Abnormal TCG, then it usually has a protective character only, in case of extraordinary data collection that would last days.

After the parameters are modified, click **Save**. The changed parameters are stored into the **tcg** file, but primarily the **Edit** buttons for **TCG Measurements List** and for **TCG Control Measurements List** get activated.

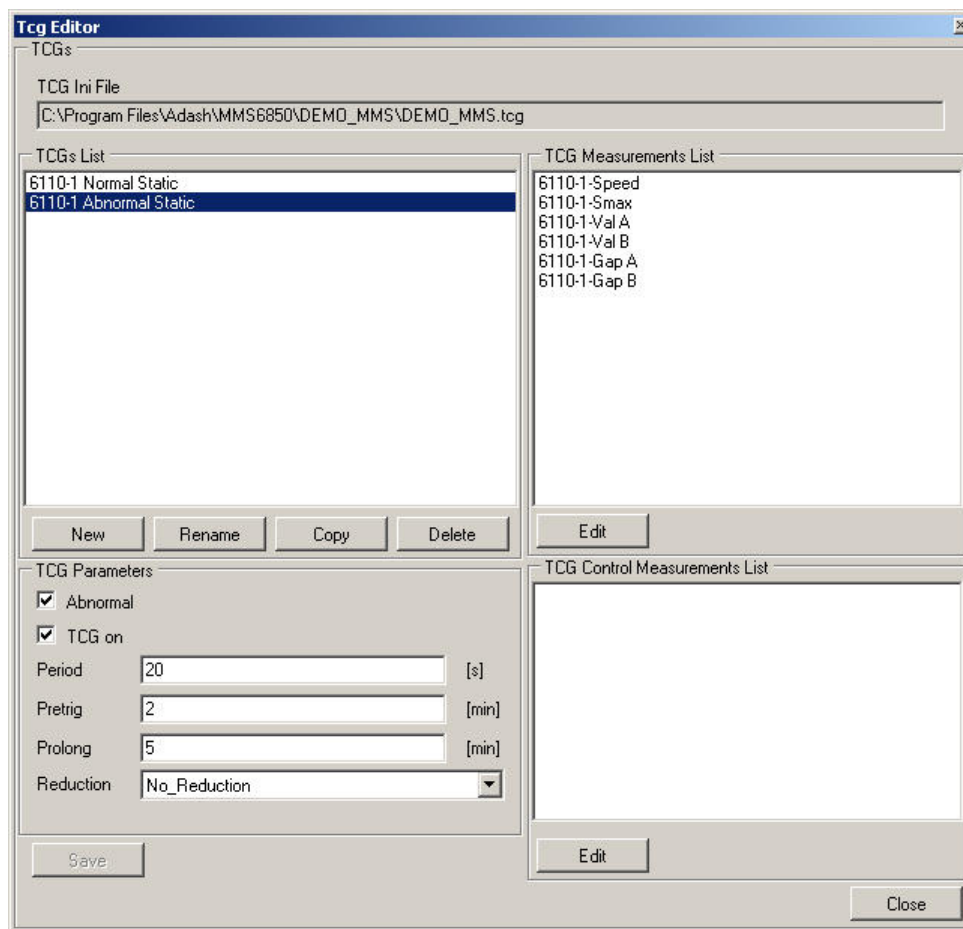

We have inherited the complete **TCG Measurements List**, and we are not going to modify it. However, there is still the most important part of definition of each Abnormal TCG – assigning of a control quantity to the **TCG Control Measurements List**, and setting its limits.

Abnormal TCG Control Quantity

Each Abnormal TCG must have at least one control quantity. Any static measurement can be assigned as the control quantity. TCGs are often controlled by speed.

ATTENTION! The current version of the Data Admin service requires that all measurements from the **TCG Control Measurements List are also contained in the **TCG Measurements List**.**

To say it differently: all Abnormal TCG control measurements must be archived into the DDS database, while the Abnormal TCG is running. The editor solves this requirement as follows:

- Measurements shown in the **TCG Control Measurements List** are not shown in the **TCG Measurements List** at the same time.
- Measurements shown in the **TCG Control Measurements List** are written into the **tcg** file for **Data Admin** as they have been mentioned in the **TCG Measurements List**.

The **Data Admin** service continuously checks a table of project control quantities, and sets control indicators for all project Abnormal TCGs according to the actual status. The abnormal TCGs are started and stopped according to the actual status of these indicators. To select the control quantities properly and set their limits and intervals is a key presumption of proper function of each Abnormal TCG. Now we are going to demonstrate, how to do it for the TCG controlled by speed only.

Task

A monitored device has nominal speed 1200 RPM. Operating speed is between 900 RPM to 1200 RPM. Decrease of the speed under 900 RPM, or increase above 1200 RPM represents an extraordinary event. Decrease of the speed under 600 RPM, or increase above 1500 RPM represents an emergency. We require the new TCG to be running during both extraordinary, and emergency operations.

Click on **Edit** for **TCG Control Measurements List**. The edit window for the **TCG Control Measurements List** opens. This window is very similar to the edit window for the **TCG Measurements List** editing, which we have seen and described in detail during creation of a Normal TCG.

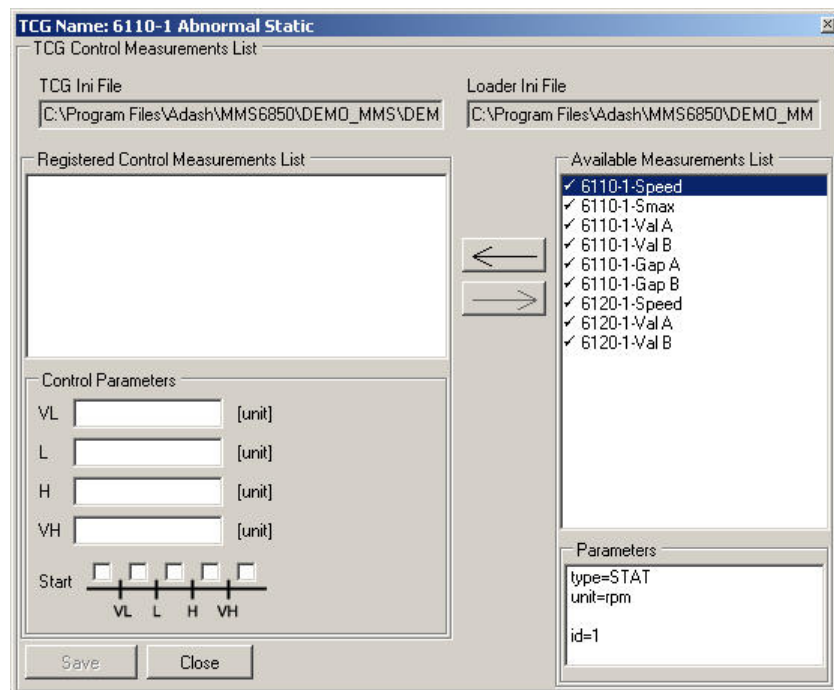

The whole right hand side of the window, i.e. **Available Measurements List** and **Parameters**, is identical with the previously described one in editing of the **TCG Measurements List**. The upper half contains a list of measurement that can be selected as control quantities. Only static measurements can be assigned as the control quantities, therefore the list does not contain any dynamic measurements. A multiple choice is possible, as was described before in the description of creation of a new Normal TCG.

In the left upper quarter is the list of the TCG control quantities. In our case this list is empty, since the TCG that is being newly created has no control quantity assigned yet. The description of the **Registered Control Measurements List** is identical to the **Registered Measurements List** description, as it was described during editing of the **TCG Measurements List**.

However, the left bottom quarter is completely new and marked **Control Parameters**. Here we can set limits and intervals of the control quantity, which has been just selected from the **Registered Control Measurements List**.

Individual limit fields have these meanings:

- VL** Very Low limit
- L** Low limit
- H** High limit
- VH** Very High limit

Measurement units are shown behind the fields. If there is no control quantity defined yet, the text "unit" appears behind the field. In case the list contains control quantities, then their units, read from the **Idi** configuration file, appear behind the fields.

The limits are the limiting interval points with the following meanings:

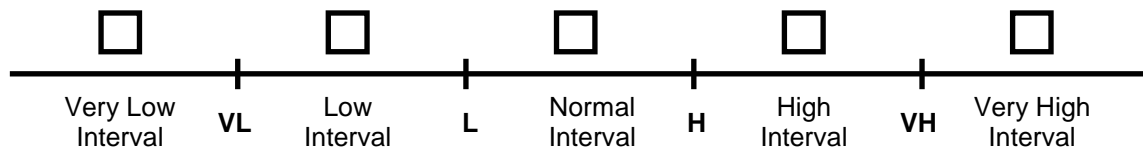

By checking the interval field we request the control quantity to be active, provided its actual value falls into the checked interval. By checking more intervals at the same time we can activate the control quantity in more intervals.

In the **Available Measurements List** click on the 6110-1 Speed measurement, which should become the control quantity of the TCG that is being created. Then click on ←. The measurement will move from the **Available Measurements List** to the **Registered Control Measurements List**. At the same time the text **unit** in the fields **VL** to **VH** changes to **RPM**, since this unit was read from the **Idi** configuration file for the selected measurement Speed.

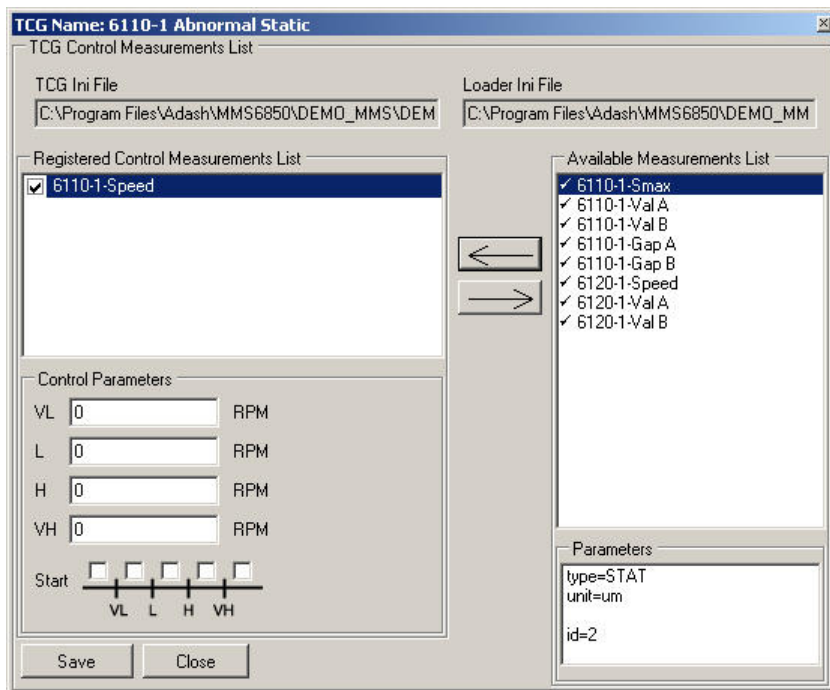

Enter the limits that are specified in the task into the fields **VL** to **VH**. At the same time check required intervals, in which should the control quantity be activated.

Only if any limit represents a change between checked and unchecked intervals it is really watched.

It is necessary to defined only the **L** limit for the next example.



Recommendation

Fill all the **VL** to **VH** fields, even if you will not be using some of the entered limits. The really watched limits in the order **VL** to **VH** must be increasing integers.

The complete Abnormal TCG definition, created according to the previously specified task, is as follows.

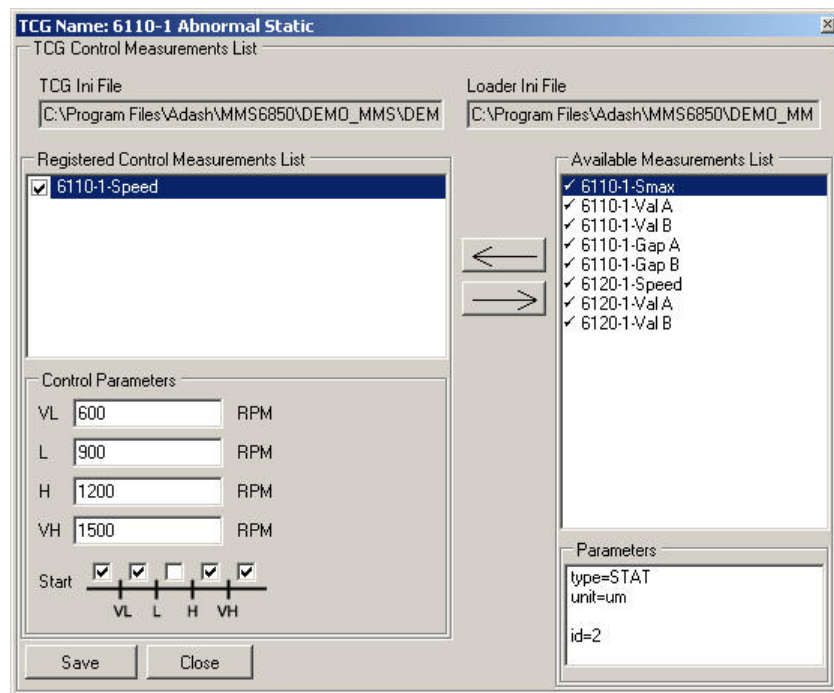

By clicking on **Save** you will save the definition in the **tcg** file. Then click on **Close** to close the **Control Measurements List** creation and editing window, this will return you to the TCGs creation and its parameter editing window.

ATTENTION! When the 6110-1-Speed measurement is added to the **TCG Control Measurements List** it is not consequently shown in the **TCG Measurements List**.

Adding of More TCGs

Other TCG definitions can be added to a project by two ways:

1. By creating a complete definition from scratch. This procedure was described in the chapter **Creation of First New Normal TCG** in detail.
2. By copying of an already existing TCG definition, which has similar parameters and especially the **TCG Measurements List** or **TCG Control Measurements List**. This procedure that can make your work significantly easier during creation of the new TCG, since you do not have to create a complete definition, but only modify some of its parameters and lists, was described in the chapter **Creation of First New Abnormal TCG** in detail.

Remarks

- If you create a new Normal TCG from the copy of an already existing Abnormal TCG, all you need to do is to deactivate the **Abnormal** field. The **TCG Control Measurements List** becomes inaccessible, so it is not necessary to erase its items in advance. Even if some list was generated into the **tcg** file, it would be ignored for the Normal TCG.
- On the other hand, if you create a new Abnormal TCG by copying an existing Normal TCG, you must, after checking the **Abnormal** field and making the **TCG Control Measurements List** accessible, create a corresponding list of control quantities.

Change of TCG Parameters

If you change parameters of a TCG, these changes will come into effect only after restarting the Data Admin service, which, after it is started, read the **tcg** file with the new parameters.

It is possible to change parameters of any already defined TCG in a project. Most of the changes is done by overwriting of the parameter value in the corresponding field of the edit window, or by adding the measurement into or removing it from the TCG list. We have become familiar with all Normal TCG and Abnormal TCG parameters and important elements of the window for work with TCGs and their measurement lists in the chapters **Creation of First New Normal TCG** and **Creation of First New Abnormal TCG**. We assume in the further text that you can create a new Normal and new Abnormal TCGs.

Change of TCG Name

Each TCG must have its name, under which it is in the **TCG Editor** in the **TCGs List**, and under which it is in the **Data Admin** service in its tables. The TCG name must be unique in the list and serves as a TCG identifier only. Its change does not cause any side effects, only the TCG will be under a new name from then on.

Renaming of a TCG is done as follows:

- In the **TCGs List** click on the TCG name you want to change.
- Click on **Rename**. The dialog to enter a new name appears.
- Enter the new TCG name, which may not be contained in the **TCGs List** yet, and confirm it by **OK**.
- The TCG will appear in the **TCGs List** under the new name.
- By clicking on **Save** you will save the change in the **tcg** file.

Adding, Removing and Suspending Measurements in TCG Lists

Each TCG definition contains the **TCG Measurements List**, which is a list of measurements, whose data should the **Data Admin** service transfer from the Online DB to the DDS DB within the TCG. An Abnormal TCG definition must also contain the **TCG Control Measurements List**, which is a list of static measurements, which control starting or stopping of this TCG. Work with both lists is methodically the same and enables:

- Adding of measurements to the list. The added measurements are moved to the list from the **Available Measurements List**.
- Removal of measurements from the list. The removed measurements go back to the **Available Measurements List**.
- Suspending or reactivating of selected measurements. The suspended measurements stay in the list, only they will not be acknowledged by the **Data Admin** service. A suspended measurement can be reactivated within the TCG definition at any time.

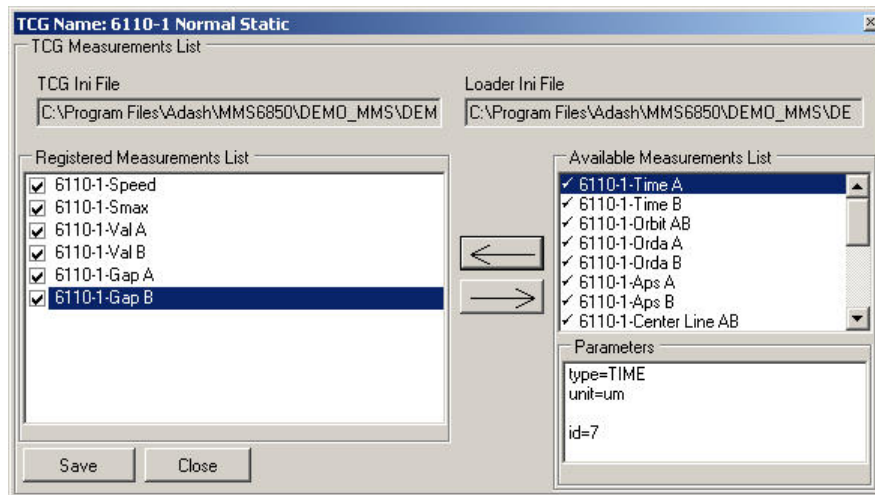

Adding of Measurement to List

In the chapter *Creation of First New Normal TCG* we have learned that measurements selected from the **Available Measurements List** can be moved to the **Registered Measurements List** by clicking on ←. The selected measurement will be moved from the **Available Measurements List** to the end of the **Registered Measurements List**. At the same time we have learnt that the measurements do not have to be moved individually, but also in whole groups. A multiple choice is possible in the **Available Measurements List** by a mouse together with **Ctrl** and **Shift**. More information can be found in the chapter *Creation of First New Normal TCG*.

Removing of Measurement from List

This is a procedure, which is the exact opposite to the above described measurement addition procedure. The measurement, this time selected from the **Registered Measurements List**, can be moved back to the **Available Measurements List** by clicking on →. The selected measurement will be moved from the **Registered Measurements List** to the end of the **Available Measurements List**. In this case we always remove the measurements individually. A multiple choice is not allowed in the **Registered Measurements List**.

Suspending of Measurement in List

In the chapter *Creation of First New Normal TCG* we have already recognised in the **Registered Measurements List** and **Available Measurements List** descriptions that measurements specified in both lists can be temporarily suspended. The description on how the process of suspending works is shown there. We will only state this information more precisely in this chapter.

The picture represents a situation, when the static measurements Gap A and Gap B are suspended in the TCG with the name 6110-1 Normal Static. We can see it on the status of checking fields on the left of the **Registered Measurements List**. On the other hand the dynamic measurements Time A and Time B are suspended in the whole **Data Loader** project. We can see it on the ✓ signs at the right hand side of the **Available Measurements List**. Now we will explain differences of these two types of interruptions.

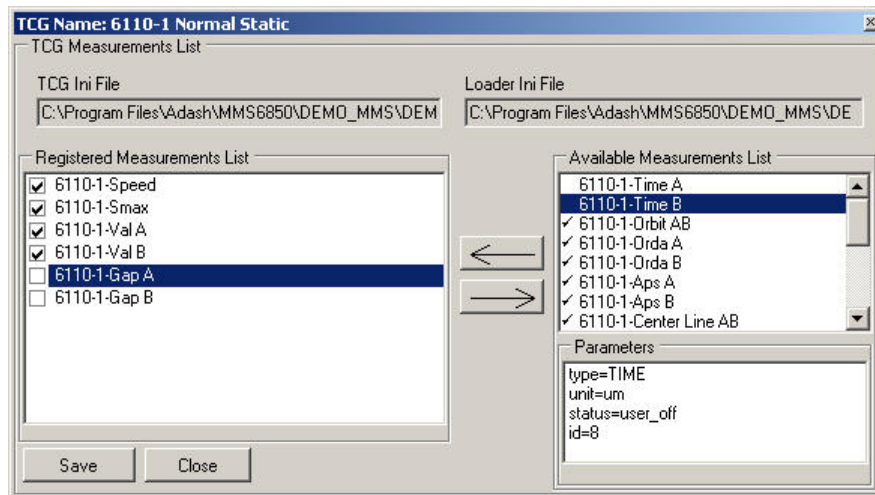

Suspending of Measurements in Data Loader Project. We can see the **Available Measurements List** in the right upper quarter of the picture. The list has been read from the **Idi** configuration file of the **Data Loader** project file. The **TCG Editor** can only read this file and does not allow to modify it. Modifications can be done only through the **Data Loader Project Editor**. The list items that are not marked by the ✓ sign, present the measurements that were suspended in the **Data Loader** project. If we select such an item from the list (see picture), we will see the line `status=user_off` between the **Parameters** at the bottom right quarter. The measurement was suspended by a user through the **Data Loader Project Editor** by the change of the item status from `user_on` to `user_off`. The **Data Loader** service will not transfer suspended measurement data from the OPC interface to the Online DB. It is like this measurement did not exist in the A3750 project at all. **If you want to suspend any measurement in a whole project (e.g. due to sensor defect), then always use this way of suspending it.**

Suspending of Measurement in Selected TCG. We can see the **Registered Measurements List** in the left half of the picture. The list has been read from the **tcg** file of the **Data Admin** project file for the selected TCG. The **TCG Editor** is used for creation and maintenance of this file, which is then fully under your control. The list items that are not marked by the ✓ sign, present the measurements that were suspended in the selected TCG. The measurement was suspended directly in this window by a user by the change of the status of the checking field. The **Data Admin** service will ignore the suspended measurement.

- If this is an item from the **Registered Control Measurements List**, then this suspended measurement will not participate in the control of its TCG. However, this does not mean that the same measurement could not participate in the control of other TCGs, in whose definitions it is not suspended!

- If it is an item from the **Registered Measurements List**, then data from the suspended measurement will not be transferred by the **Data Admin** service from the Online DB to the DDS DB, but again only within its TCG. It does not mean at all that the data from the same measurement could not be transferred within other TCGs, in whose definitions this measurement is not suspended! **Even the data from a suspended measurement can still be transferred into the DDS database, however, according to parameters from another TCG.** So this is a big change of behaviour with regard to the previous case. The suspended measurements are suspended only within their TCGs, but not in the **Data Admin** project. And not at all in the whole A3750 project! It is as if the measurement did not exist only in the definition of the selected TCG. **If we want to suspend a measurement inside of just one TCG definition, then we should use this method.**

Remember, when suspending measurements in TCG:

- If you suspend all measurements in the **Registered Control Measurements List**, then the corresponding Abnormal TCG will never be started. By suspending the last list item you will disable control of such Abnormal TCG. The TCG will then behave the same way, as if its **Control Measurements List** were empty.

- If you suspend a measurement from the **Registered Measurements List**, it does not mean that data from this measurement cannot keep transferring, thanks to some other TCG definition, to the DDS database.

- If you suspend a measurement from the **Registered Measurements List** and its data will not be transferred to the DDS database any more, they will still accumulate in the Online DB, which is not desirable. In this case suspend the measurement in the **Data Loader** project, as was described above.