



Installation Guide

Bacharach Communications Adapter

HGM-MZ to Johnson Controls' Metasys N2 Network (Electrically Isolated N2 Port Version)

621 Hunt Valley Circle
New Kensington, PA 15068
Tel: 724-334-5000
Fax: 724-334-5001

Instruction 3015-5514
Revision 1
October 2012

1. Introduction

The Bacharach HGM-MZ to Johnson Metasys N2 Communications Adapter enables an HGM-MZ Refrigerant Monitor to communicate with a Metasys building management system. The following may be viewed on Metasys operator stations.

- Zone PPM readings
- Flow status
- Refrigerant selections
- HGM internal health.

In addition, each HGM zone supports three levels of alarming through Metasys.

- Leak
- Spill
- Evacuate

Each alarm threshold can be set through Metasys.

The N2 Communications Adapter can be used in conjunction with the MZ-RD Remote Display if desired. Wiring details and operational limitations when using the MZ-RD are discussed below.



CAUTION: The adapter is powered from the 120/240V Universal Power Supply connection on the HGM main board. 120/240V is present on the lower left corner of this adapter within the area shown on the board silkscreen. *Keep fingers away from this area when HGM is powered.*

2. Adapter Installation Inside HGM-MZ

The communications adapter board will normally be installed in the HGM-MZ at the factory. It can, however, be field installed by following the instructions below.

The following installation materials are needed for field installation of the adapter:

- Qty (5) 6-32 x 1/4" screws (standard finish)

HGM-MZ to N2 Communications Adapter

Step	Description
1.	The adapter board mounts on the rear of the HGM-MZ enclosure door. Position the adapter board over the five standoffs on the door and install with 6-32 fasteners through the board and into the standoffs.
2.	Connect power wiring from the HGM-MZ's 120/240V Universal Power Supply terminal block to the adapter board's POWER terminal block. Use UL approved wire. Wire polarity does not matter.
3.	If an MZ-RD remote display is NOT used with the adapter, refer to Figure 1 for wiring details. In this case, all wiring between the HGM-MZ and the only external cable is the N2 communications cable.
4.	If an MZ-RD remote display IS to be used with the adapter, refer to Figure 2 for wiring details. Note that when the MZ-RD is used, TWO RS-485 cables must be run between the HGM-MZ and MZ-RD, so plan accordingly.
5.	In either case, be sure to set the HGM-MZ's internal "terminator" slide switch next to the RS-485 terminal block to the "In" position.

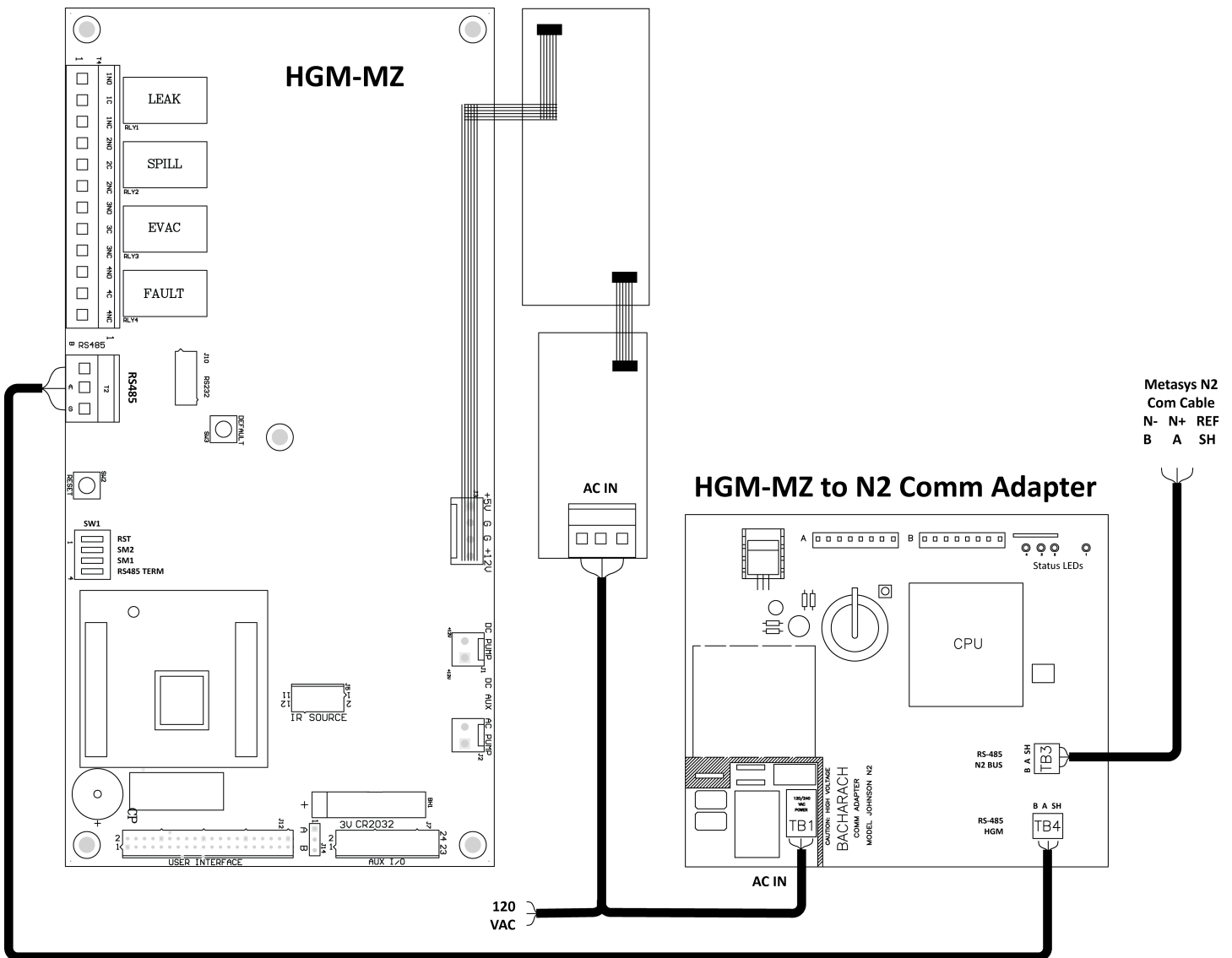

Figure 1 – Wiring w/o Remote Display

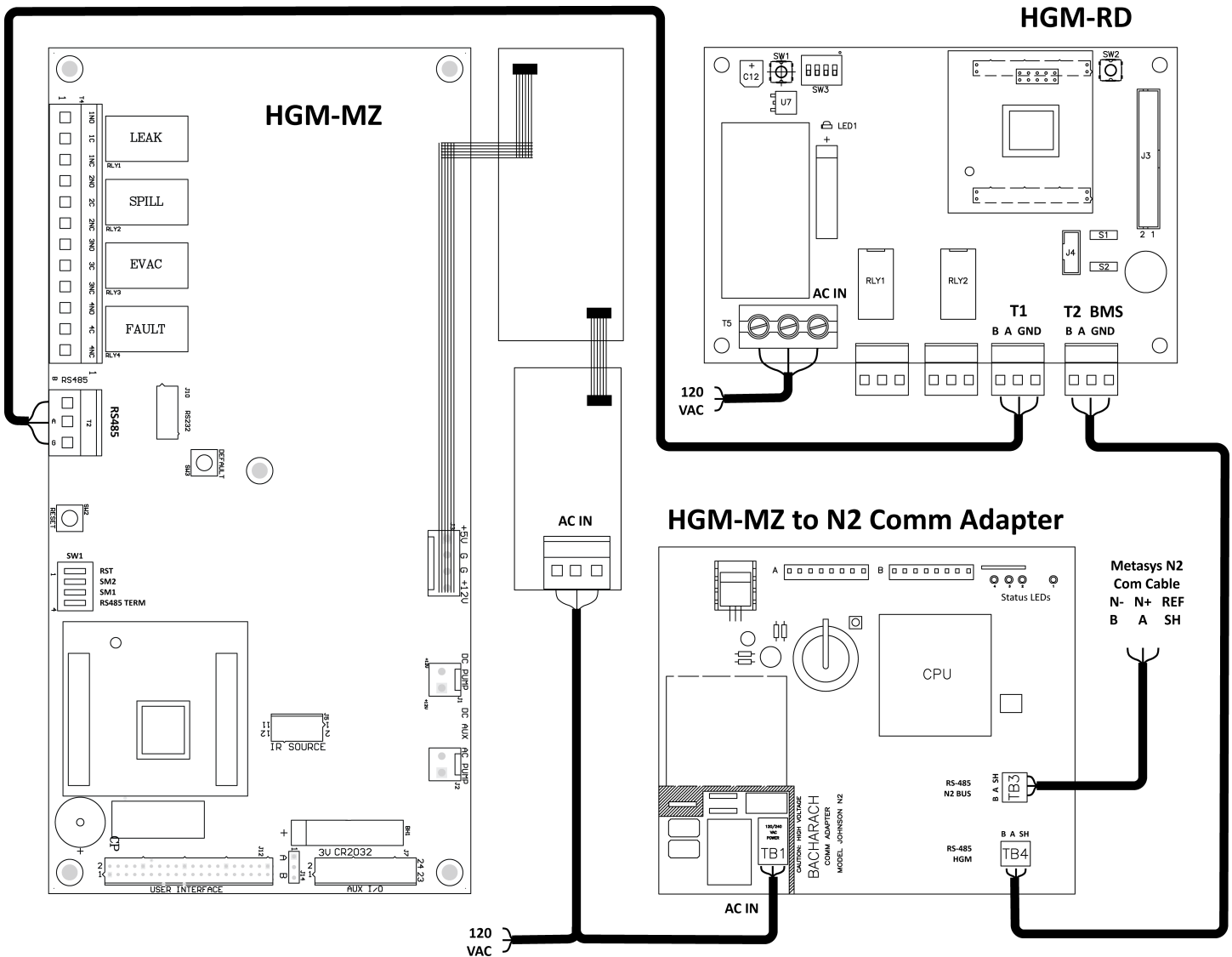

Figure 2 – HGM-MZ to N2 Communications Adapter: Wiring w/Remote Display

3. Field Hookup of N2 Communications

The “BAS BUS” (N2) RS-485 communications port on the adapter is electrically isolated from the HGM-MZ and from earth ground. This prevents problems with potential differences in “ground” between physically separate locations.

Connect the N2 ‘+’ wire to the BAS BUS N+ terminal block screw. Connect the N2 ‘-’ wire to the BAS BUS N- terminal block screw. Connect the N2 REF wire to the BAS BUS REF terminal block screw. Shield connection practices vary. Refer to Johnson Controls Metasys N2 documents for Johnson-recommended practices. Options are to hard-terminate the shield to the case, soft-terminate (through a small-value capacitor) the shield to the case, or leave the shield floating.

If the adapter is the last device on the N2 line, the RS-485 TERM jumper just below the BAS BUS terminal block should be installed. Otherwise leave the RS-485 TERM jumper disconnected.

4. Setting the HGM Communications Address on the Adapter

See Figure 3 for the location of adapter DIP switches A and B. Switches 5-8 on the adapter's 'A' DIP switch are used to match the node address set on the HGM's address DIP switch (on the HGM main board). Values from 0-15 are possible. Refer to the table that follows.

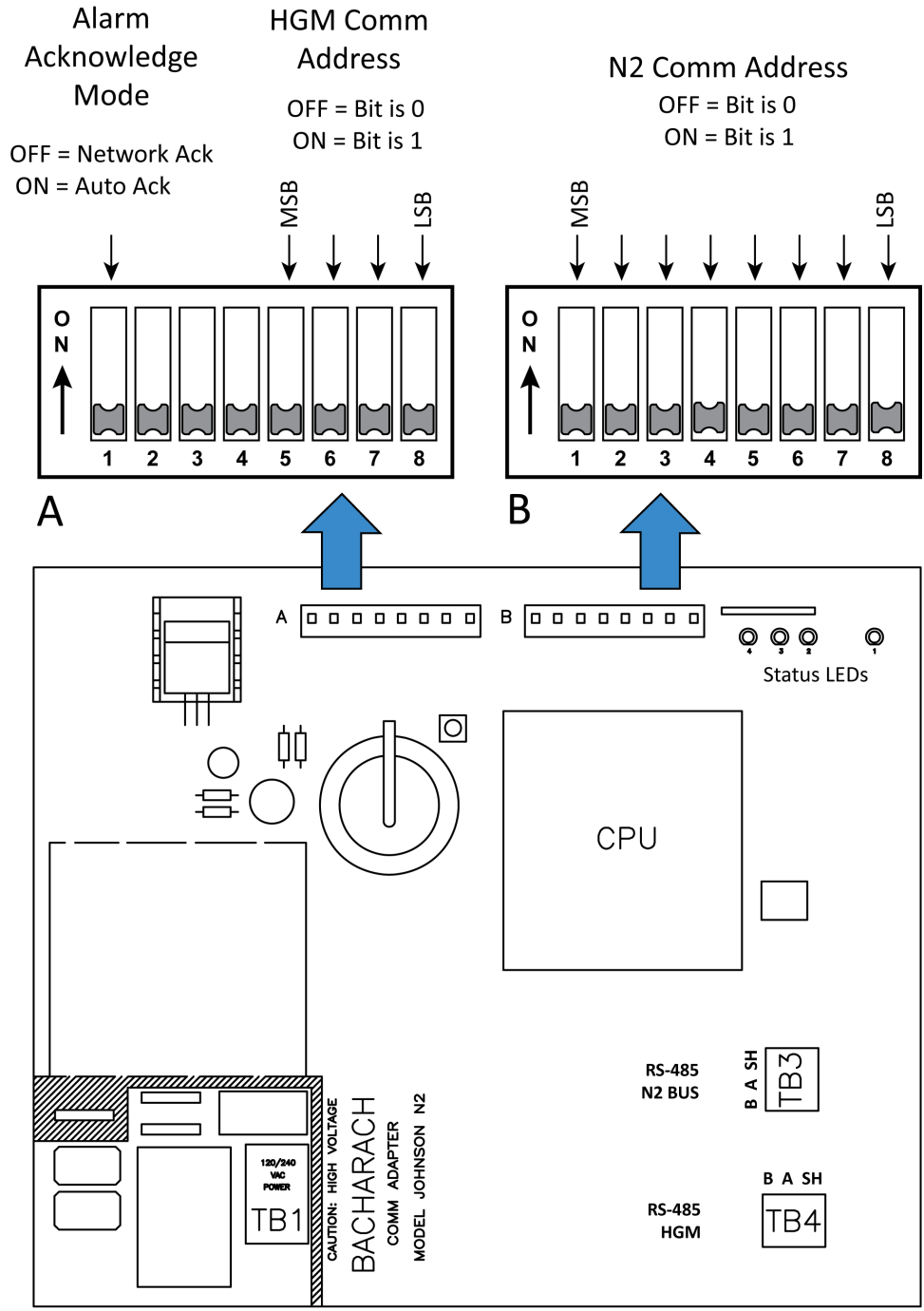

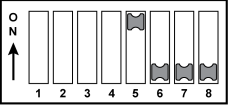
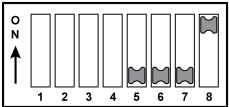
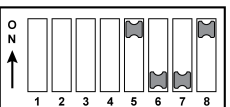
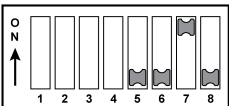
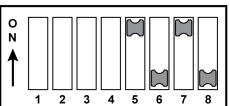
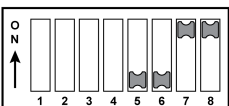
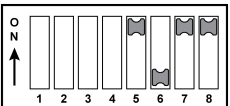
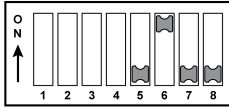
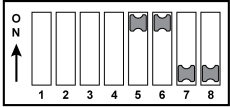
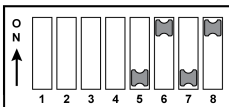
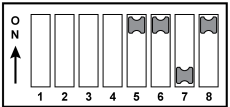
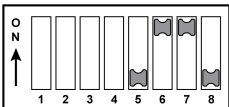
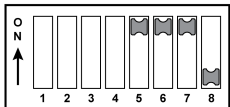
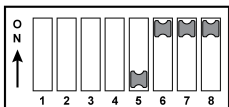
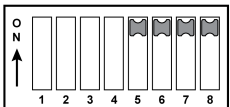

Figure 3 – HGM-MZ to N2 Communications Adapter: DIP Switches

HGM Addr	A5	A6	A7	A8	Switch Positions	HGM Addr	A5	A6	A7	A8	Switch Positions
0	Off	Off	Off	Off		8	On	Off	Off	Off	
1	Off	Off	Off	On		9	On	Off	Off	On	
2	Off	Off	On	Off		10	On	Off	On	Off	
3	Off	Off	On	On		11	On	Off	On	On	
4	Off	On	Off	Off		12	On	On	Off	Off	
5	Off	On	Off	On		13	On	On	Off	On	
6	Off	On	On	Off		14	On	On	On	Off	
7	Off	On	On	On		15	On	On	On	On	

Since the HGM is the only node on the adapter-to-HGM interface, address 1 is normally used. Be sure to set the same address on the adapter and the HGM main board DIP switches.

5. Configuring the HGM-MZ with MZ-RD or Laptop PC

The only HGM parameters that are changeable through Metasys are the alarm thresholds. Configuring the HGM for refrigerant type and length of tubing for each zone (zero length to disable a zone) must be done with the MZ-RD remote display or a laptop PC. Refer to the appropriate Bacharach instructions for configuring these items. HGM's are commonly custom-configured at the factory per the customer's needs, so field configuring these parameters may not be necessary.

If configuring the HGM-MZ with an MZ-RD, the communications adapter's presence will not affect the standard configuration procedure. If configuring with a laptop PC, temporarily disconnect the HGM-MZ's RS-485 cable from the adapter until configuration is complete and the laptop is disconnected.

7. Alarm Acknowledge Options

Two alarm acknowledge options are supported. DIP switch A1 on the adapter board selects which alarm acknowledge option is used.

- Auto Acknowledge (A1 On)
- Manual Acknowledge (A1 Off)

In the Auto Acknowledge mode, the HGM-MZ will clear its alarm outputs the next time the alarmed zone is sampled and its PPM has dropped below the alarm thresholds. No intervention from the Metasys network is necessary.

In the Manual Acknowledge mode, the HGM-MZ will never clear its alarm outputs until the Metasys network connection has acknowledged the Change-of-State alarms reported to Metasys. Once Metasys has acknowledged the alarm messages, the HGM will clear its alarm outputs the next time the alarmed zone is sampled and its PPM has dropped below the alarm thresholds. Please note that the Metasys acknowledgement is a field-level acknowledgement that takes place automatically (typically within a few seconds). It is not a human operator acknowledging that the alarm was seen on a console. The Metasys acknowledgement does, however, mean that the system has caught the alarm and that it will be reported to some higher level.

8. Setting up the Metasys Database

The Metasys Point Map included with this document will provide the information needed to set up AI (analog input), BI (binary input), and ADI (internal integer) points in the Metasys database. Additional comments are provided below to supplement the map. The HGM-MZ can support up to 16 zones in groups of 4 zones, but a particular HGM-MZ may not have all zones installed. It is not necessary to include points in the Metasys database for zones that are not installed in the HGM-MZ.

Each monitored zone in the HGM supports three levels of alarming: Leak, Spill, Evacuate. Since the Metasys N2 architecture does not support three different levels of high alarming per AI point, each HGM zone is set up as THREE AI points. The first AI point for a zone supports a Leak Alarm, the second AI point for a zone supports a Spill Alarm, and the third AI point for a zone supports an Evacuate Alarm. All three AI points for a zone return the same PPM reading, it's the alarm thresholds that differ.

Alarm thresholds in PPM are set through Metasys by setting each AI point's "High Alarm Limit." Each alarm threshold may be set to a value of 1-65535 PPM. Please note that for a particular zone, the Spill threshold must be set higher than the Leak threshold, and the Evacuate threshold must be set higher than the Spill threshold. All Metasys warning/alarm limits other than "High Alarm Limit" are ignored. Because the HGM samples slowly, alarm "differential" to prevent alarm chattering is not needed. Therefore the Metasys "Differential" parameter for each AI may be written but will be ignored.

Certain HGM faults will cause various points to be marked unavailable/unreliable. For example, a global flow fault will cause ALL AI PPM values to be marked unreliable, whereas a flow fault on a single zone will only cause the three AI PPM values associated with that zone to be marked unreliable. Note that any time power is cycled to the HGM, it goes through a 15-minute warm-up cycle (even if it was already warm!). During this time, all AI PPM values will be marked unreliable. Don't cycle HGM power needlessly if you would like to get valid PPM readings with the next 15 minutes!

There are several ADI points which can provide useful information such as type of refrigerant programmed for each zone, number of zones actually installed in the HGM, the number of zones in alarm, HGM operating mode, etc.

9. Communications LED Indicators

The communications adapter board has four LED communications status indicators numbered 1-4. The meanings of these indicators are shown below. See Figure 3 for the locations of the communications LED indicators.

LED	Adapter Function	Meaning When LED Is in the "ON" State
1	Tx	Adapter is transmitting a poll/command to the HGM-MZ
2	Rx	Adapter is receiving a response from the HGM-MZ
3	Tx	Adapter is transmitting a response to Metasys N2 (because poll/command was directed to this slave)
4	Rx	Adapter is receiving a poll/comm from Metasys N2 (directed to ANY N2 slave, not necessarily this one)

Under normal conditions, you would expect to see a lot of activity on LED 4 since the N2 master is continually polling all N2 slaves on the line. LED 3 will show activity based on how often the N2 master is polling the adapter (versus other N2 slaves on the line). If there are few N2 slaves on the line, a lot of polls will be directed to the adapter and LED 3 will blink frequently and LED 3 will blink less frequently.

LED 1 and LED 2 will only show occasional activity. Since the refrigerant monitoring process is fairly slow and new data is only available every 15 seconds or so, the adapter polls the HGM at a slow rate to reduce the communications burden on the HGM main processor.

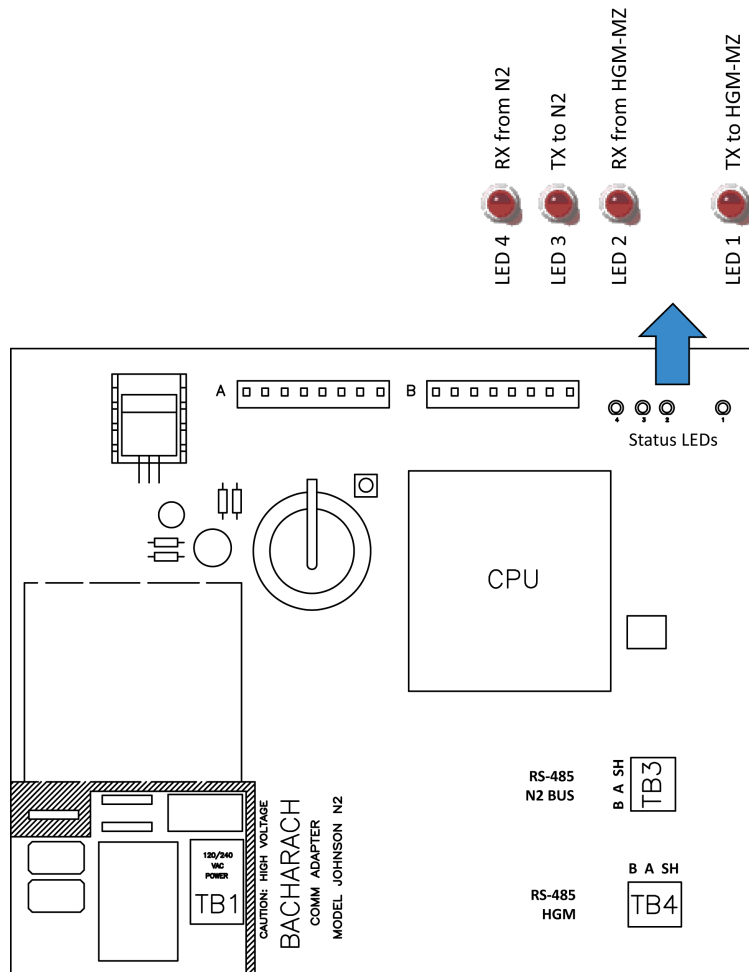

Figure 4 – HGM-MZ to Metasys N2 Adapter: Communications LEDs

10. Operating Limitations When Using MZ-RD Remote Display

When an MZ-RD remote display is used, the N2 network will have access to the HGM-MZ as long as the MZ-RD is in either the SYSTEM or ZONE VIEW screen. If the MZ-RD is set to display any other screen, it will respond to polls from the N2 adapter with an HGM BUSY exception code. The N2 adapter will handle the exception by marking most points as Unavailable and setting the Unavailable Reason point = HGM Busy. When the MZ-RD is returned to the SYSTEM or ZONE VIEW screen, normal N2 monitoring will resume.

If the operator leaves the MZ-RD in some screen other than SYSTEM or ZONE VIEW for an extended period of time (10 minutes default), the MZ-RD times out and automatically returns to either the SYSTEM or ZONE VIEW screen. This will restore normal N2 monitoring.

11. Miscellaneous Notes

RS-485 communications wires ARE polarity sensitive. If the adapter does not communicate on the N2 RS-485 port, try swapping the communications wires on the N+ and N- terminal block screws. The HGM port uses the same labels as the HGM main board, so if you match the wires to the labels, polarity should not be an issue there.

If the adapter seems to not be functioning correctly, it can be restarted without restarting the HGM simply by pressing the CPU RST button just below the “A” DIP switch. If you restart the adapter by cycling the HGM’s power, you will have to wait for the HGM’s 15-minute warm-up cycle to end before PPM readings are available! If restarting the adapter alone doesn’t help, try cycling power to the entire HGM.

When the adapter software first starts, it attempts to establish communications with the HGM before attempting to communicate on the N2 port. Do not be concerned after cycling power or pressing CPU RST that no N2 activity is shown on the LEDs immediately. The software delays about 20 seconds after a restart before attempting to establish N2 communications.

The LEDs are driven by adapter software states, not by the RS-485 hardware. If an RS-485 connection stops working in the middle of receiving a message, the RX LED may stay on indefinitely until the connection starts working again.





Headquarters:

621 Hunt Valley Circle, New Kensington, PA 15068-7074

Toll Free: 1-800-736-4666 • Tel: +1-724-334-5000 • Fax: +1-724-334-5001

Website: www.MyBacharach.com • E-mail: help@MyBacharach.com

