

Instructions specific to hazardous area installations (reference European ATEX Directive 94/9/EC, Annex II, 1.0.6.)

The following instructions apply to equipment covered by certificate number Sira 05ATEX2027X for the CEL-320/IS and CEL-360/IS:

- 1 The equipment may be used with flammable gases and vapours with apparatus Groups IIA, IIB and IIC and with temperature classes T1, T2, T3 and T4.
- 2 The equipment is only certified for use in ambient temperatures in the range -20oC to +40oC and should not be used outside this range.
- 3 The certificate marking is detailed on drawing numbers 13-1920001A/IS-03 and 13-1920002A/IS-03.
- 4 Repair of this equipment shall be carried out by the manufacturer or in accordance with the applicable code of practice.
- 5 The certification of this equipment relies on the following materials used in its construction: Polybutylene terephthalate (PBT) and Polycarbonate (PC)

If the equipment is likely to come into contact with aggressive substances, then it is the responsibility of the user to take suitable precautions that prevent it from being adversely affected, thus ensuring that the type of protection is not compromised.

Aggressive substances e.g. solvents that may affect polymeric materials

Suitable precautions e.g. regular checks as part of routine inspections or establishing from the material's data sheet that it is resistant to specific chemicals.

- 6 The certificate number has an 'X' suffix that indicates that the following special condition of certification applies;
Under certain extreme circumstances, the non-metallic parts incorporated in the enclosure of this equipment may generate an ignition-capable level of electrostatic charge. Therefore, when it is used for applications that specifically require group II, category 1 equipment, the equipment shall not be installed in a location where the external conditions are conducive to the build-up of electrostatic charge on such surfaces. Additionally, the equipment shall only be cleaned with a damp cloth.

If you want to get on and use the instruments without any background information, skip Sections 3 - 5 and go straight to Section 6.

1. Display

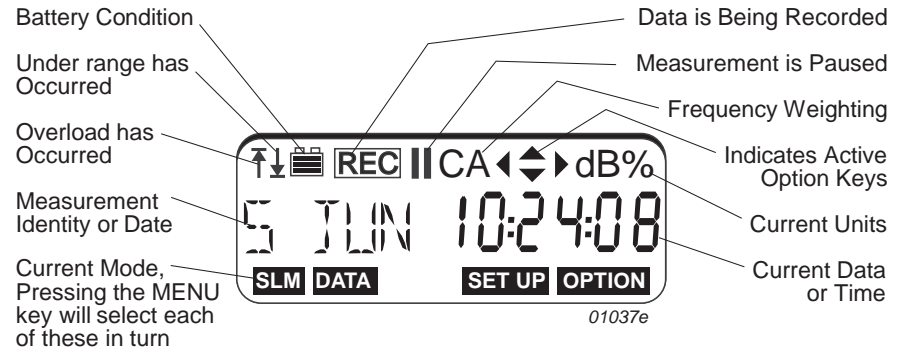

2. Keys

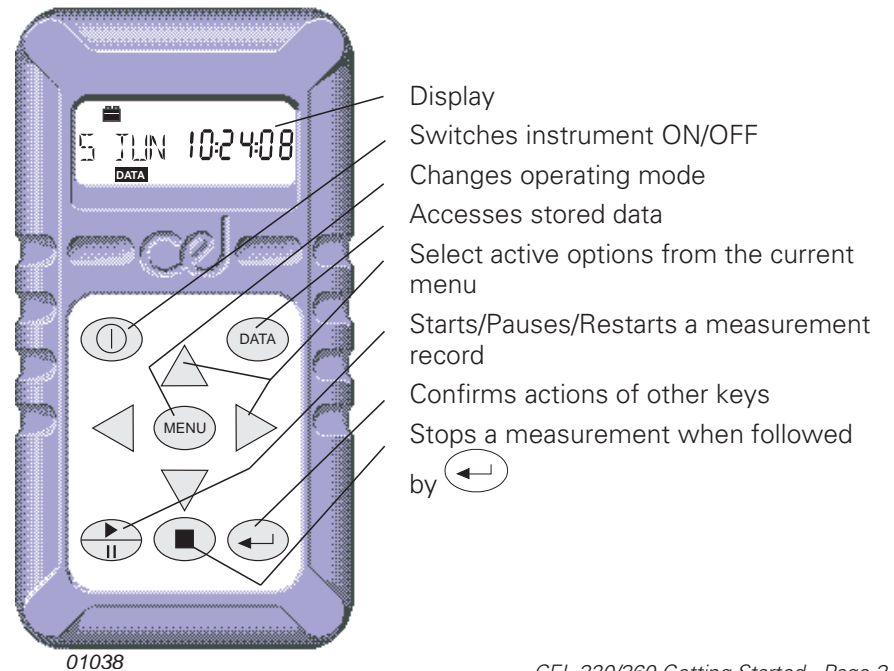

3. Contents

Section	Page	Section	Page
1 Display	3	6.4 Review Stored Data	10
2 Keys	3	6.5 Print Standard Report	11
3 Contents	4	7 Operation as a Sound Level Meter	12
4 Introduction to the Dosimeters	4	8 Selecting and Changing Options	13
4.1 Sound Level Meter Models	5	8.1 Review Options	13
4.2 CEL-320/320S Noise Dosimeters	5	8.2 Set Time & Date	14
4.3 CEL-360/360S Logging Noise Dosimeters	6	8.3 Change Timer and Run Duration (CEL-360 Series) .	14
5 Preparation for Use	7	9 Technical Information	16
5.1 Install Battery and Microphone	7	9.1 Specification	16
5.2 Perform Acoustic Calibration	7	9.2 CE Compliance	18
6 Operation as a Dosimeter .	9	9.3 Default Parameter Settings	18
6.1 Select Dose Set Up for Use	9	9.4 Parameter Identities	19
6.2 Measure and Store Dose Data	9	10 Parts, Servicing & Warranty	20
6.3 Recall Dose Data	10	10.1 Schedule of Parts	20
		10.2 Servicing & Warranty Arrangements . . .	20
		11 Intrinsically Safe Models .	22

4. Introduction to the Dosimeters

The CEL-320 and CEL-360 Noise Dosimeters have been developed from the successful CEL-420/460 range of instruments by adding features and improving the control procedures. They measure the frequency weighted noise exposures and peak sound levels simultaneously.

The dosimeter microphone and lead on both models can be replaced by a sound level meter microphone to offer comprehensive sound level measurement. The CEL-320/360 series instruments have the following features.

- ▣ Seven built-in standard dose measurement setups:
OSHA, MSHA, DOD, ACGIH, ISO85*, ISO90* and METER
- ▣ Up to 13 user specified dose measurement setups,
- ▣ A single sound level meter (SLM) setup,
- ▣ 50 dose (DATA) result stores,
- ▣ Storage of up to 10 profiles attached to each CEL-360 dose measurement, as specified by dB10 or dB12 software,
- ▣ Self configured storage.

The instruments are built to withstand rough industrial conditions with cases formed from a polyester/polycarbonate material that gives them a

Note*: ISO procedures using Criterion 85 dB and 90 dB.

high resistance to damage. Data integrity is further protected by a dose microphone lead which is designed to resist knocks and abrasions without affecting the signal passing from microphone to instrument.

Both instruments can be operated and deliver dose and SLM results without the need for other equipment, beyond an acoustic calibrator. However, they become even more versatile when their measurement and setup data is transferred via a PC using the CEL-6702 dB10 or CEL-6704 dB12 Windows™ based software.

These programs enable the instruments to be fully configured. Dose (DATA) setups can be added or removed from the instrument, while the individual measurement parameters can be added, deleted or changed in a setup. Some setup parameters, such as measurement range, can either be set to a particular value or left to the user to change via the instrument keypad.

dB10 and dB12 have the facilities expected of fully featured 32 bit Windows™ packages, enabling report production with cut and paste between applications and comprehensive word processing capabilities. In addition, dB12 has extensive on screen graphing facilities.

4.1 Sound Level Meter & Intrinsically Safe (IS) Models

Both dosimeters can be converted to a miniature sound level meter by fitting a CEL-425 SLM Microphone Adaptor. The CEL-320 becomes a CEL-320S Sound Level Meter, while the CEL-360 becomes a CEL-360S Logging Sound Level Meter.

Table 1: Models Available

Standard Model	Description
CEL-320	Noise Dosimeter
CEL-320S	Sound Level Meter
CEL-360	Logging Noise Dosimeter
CEL-360S	Logging Sound Level Meter

For sound level meter operation refer to Section 7.

Intrinsically safe versions are available of both dosimeter and sound level meter models.

The part numbers have “/IS” after their standard part number. The model line up is shown in Table 1.

4.2 CEL-320/320S Noise Dosimeters

The following features apply to the CEL-320 and CEL-320S. These instruments are ideal for quick on-site surveys and for monitoring personal noise exposure in accordance with European ISO or USA OSHA, MSHA, DOD and ACGIH standards.

For dose measurement, they are passive instruments with settings that may be reviewed by key strokes, but which can be selected only by means of the dB10 or dB12 software.

However, all sound level measurement parameters can be set from the keypad. There are three overlapping measurement ranges: 30 - 100, 50-120 & 70-140 dB, A & C RMS weightings, Linear & C Peak weightings, Fast, Slow & Impulse time weightings, and energy exchange rates (Q) of 3, 4, 5 & 6. In dose measurement mode, they display % dose, % dose projected for an 8 hour period, peak level and measurement duration.

Table 2: Setups and Configuration Files

Parameter settings that do not modify preset measurement protocols can be changed by using the instrument keys.

All available parameter settings can be changed from a PC by means of dB10 or dB12 Software.

Parameter settings that modify preset measurement protocols must first be saved by dB10 or dB12 under a new setup identity in an instrument "configuration file".

A "configuration file" contains a complete instrument set of setups, i.e. seven fixed dose setups, up to 13 user defined setups, one SLM setup, and one timer setup common to all dose setups.

Parameter settings on an instrument can be changed ONLY by using dB10 or dB12 to replace the configuration file in the instrument by another configuration file loaded from the PC.

For countries that are subject to European Union regulations or the equivalent ISO standards, these instruments measure the daily sound exposure level ($L_{Aeq,8hr}$ Pa²h according to IEC 1252, which is identical with the $L_{EX,8h}$ required by ISO 1999), while for USA OSHA/MSHA regulations they measure the Time Weighted Average level (TWA).

When used as a sound level meter they display sound level, maximum sound level, minimum sound level, peak, time-averaged (L_{Aeq} or L_{Avg}) sound levels and sound exposure level (SEL).

4.3 CEL-360/360S Logging Noise Dosimeters

In addition to the features available to the CEL-320 Dosimeters, the following additional features apply to the CEL-360 and CEL-360S. These instruments are recommended for detailed measurements as they include extended processing and memory functions.

There are automatic run timing facilities controlled by the built-in clock and time-history recording capabilities that allow up to 10 profiles to be saved with each dose (DATA) result set, in a separate profile store. Sampling times can be specified between 1 s and 1 hour by dB10 and dB12 software, while profile storage is in excess of 220 000 data points, where any single run can use up to 99 999 points.

The instruments are able to measure and save up to five user specified L_n values (exceedance level percentiles). Run durations specified via instrument keys, by dB10 or dB12, and start and stop times preset via dB10 or dB12 can be switched on or off from the instrument keys. Other settings can be changed only by dB10 and dB12 Software.

Once data saved by a CEL-360 instrument has been downloaded to a PC, the user can specify a period over which to re-calculate the projected % dose values. The software can also calculate six exceedance time percentiles with levels preset to values specified by measurement standards, plus one user specified time percentile.

5. Preparation for Use

5.1 Install Battery & Microphone

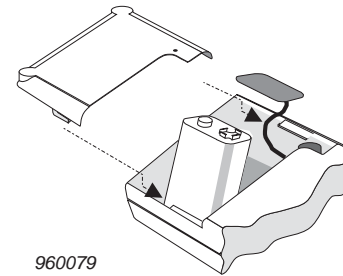

Connect a new 6LF22 or equivalent 9 V battery to the terminals in the battery compartment in the rear of the instrument.

DO NOT disconnect the battery once runs have been stored as they will be lost !

With the instrument switched OFF, insert the lead connector of the CEL-6681 Dosimeter Microphone or the

connector on the CEL-425 SLM Adaptor stalk into the socket on the top end of the case with the red dot facing the front of the dosimeter.

Remove the connector ONLY by pulling on the knurled sleeve.

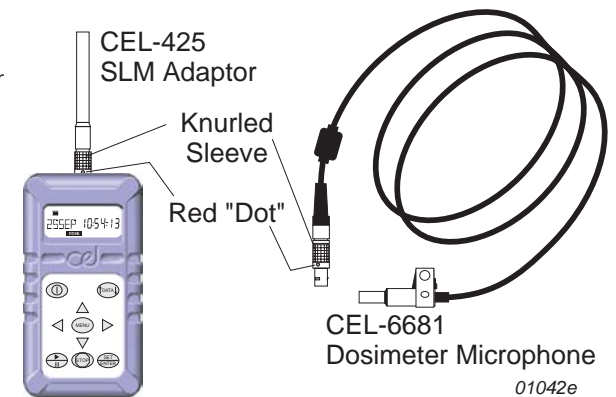

5.2 Perform Acoustic Calibration

Operations are controlled by a sequence of key strokes.

Perform a field accuracy check each time the instrument is switched ON using a CEL-110/2 (Class 2) or CEL-110/1 (Class 1) Calibrator as follows. It is also recommended that another acoustic calibration be performed immediately after completing a measurement run.

The calibration levels from both before and after are stored with the run. When the second calibration occurs much later, provided the same microphone assembly is used, the second level is attached to any stored run that has no second calibration.

Fit the CEL-4726 Coupler supplied with the calibrator (CEL-110/1 or 110/2) into the calibrator cavity, making sure it is firmly in contact with the shoulder in the cavity. (To aid removal, the coupler flange does not fit close against the calibrator housing).

Fit the microphone into the coupler cavity, again ensuring that it makes contact with the shoulder in the coupler cavity.

Then follow these instructions.

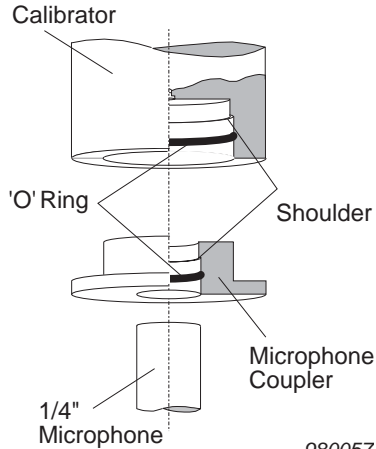



980057



Operation	Press	Display Shows	Comments
1. Switch the instrument ON			Start Up messages show: Instrument Type, Serial Number (when set), Print (when printer cable connected), Firmware Version, finishing with the Last Used Operating Mode.
2. Change Operating Mode	 re-peatedly		To select OPTION, to enable Acoustic Calibration, it shows current SPL.
3. Enable Level Change			are now enabled. The display shows current sound level.
4. Change Indicated Level	or 		Press or . Indicated level rises (falls) 0.05 dB for each key press. Adjust to correct level for CEL-320/360 microphones at standard temperature and pressure: 114.0 dB .
5. Set Calibration Level			The 114.0 dB calibration level is now set, and will be stored in the microphone assembly.
6. If the calibration is to be aborted			The calibration level is NOT SAVED and the instrument continues to use the last saved calibration.

















6. Operation as a Dosimeter

6.1 Select Dose Setup for Use

Operation	Press	Display Shows	Comments
1. Change Operating Mode	MENU re-peatedly		To select SET UP. The first display always shows the currently loaded Setup, (for example OSHA dose measurement).
2. Select another Set Up	▽ several times		Select required Set Up from OSHA dose procedures, MSHA dose procedures, DOD dose procedures, ACGIH dose procedures, ISO85 dose procedures, ISO90 dose procedures, METER procedure, SLM (see Section 7). METER is a special procedure with neither threshold nor criterion, that allows the instrument to store data as a logging sound level meter.
3. Load Selected Set Up for use	←		Loaded messages show the Setup is now active (for example ISO procedure with 90 dB Criterion).

6.2 Measure and Store Dose Data

Operation	Press	Display Shows	Comments
1. Change Operating Mode	MENU re-peatedly		This is dose measurement where the display can show dose data.
2. Start Run	▶ 		When the run TIMER of a CEL-360 is ON (Section 8.3) with Beginning and End times set, the instrument waits showing the pause icon and the time remaining until the run starts. When the run TIMER of a CEL-360 is ON (Section 8.3) with SYNC ON, the instrument waits until the clock is synchronised with any selected profile time before the run starts. When the run Timer of a CEL-360 is OFF (section 8.3), or with a CEL-320, the instrument waits until the next whole clock second, then starts the run.

Operation	Press	Display Shows	Comments
3. Then			REC icon indicates that the instrument is now storing dose data in the first available data store.
4. Inspect data from Current Run			Shows where data from the current run is being saved (store 4) and on a CEL-360 indicates the number of completed profile periods.
5. Inspect further data from Current Run	 several times	Data from Current Run. Pressing  as for the CEL-420/460 series will also cycle the display.	The display cycles through data from current run (see Section 9.4). Some of these displays offer  and  options that show further parameters. The displays will be updated while the run is in progress.
6. If Required		Pause the run.	The pause icon () is shown. Press this key again to resume the run.
7. If Required	 PLUS 	To lock the keys and display to prevent unauthorised tampering.	The keys and display cannot be locked while the instrument is paused.
8. If Required	 PLUS 	To unlock the keys and display to restore normal operation.	
9. Stop Run			Stop ? This command must be confirmed.
10. Confirm Stop			The Run is now ended. All stored runs will be lost if the battery is disconnected !

6.3. Recall Dose Data

Measured data stored while operating in the DATA mode can be accessed via the  key. Data from the run in progress can be inspected while the instrument is recording, as described in Steps 4 and 5 of Section 6.2. When the instrument is stopped, with no data being saved, stored data can be retrieved and displayed.

6.4 Review Stored Data

Stored data is identified by date and measurement start time. Up to 50 runs can be stored simultaneously before the memory is overwritten by a "first-in/first-out" process.

Operation	Press	Display Shows	Comments
1. Enable Data Recall			With the instrument stopped, pressing displays the Start Date & Time for the most recently stored run.
2. Review Stored Runs			Select Start Date & Time for required run (for example 4 June 09:10:00).
3. Review Stored Data			Shows where data from the selected run is stored (store 3) and on a CEL-360 indicates the number of completed profile periods.
4. Review Stored data			The display cycles through data from the selected run (see Section 9.4).

Pressing as for the CEL-420/460 series will also cycle the display.

Some of these displays offer and options that show further parameters. If a printer is connected and switched on, the second data display shows PRINT READY (see Section 6.5).

6.5 Print Standard Report

With the dosimeter switched OFF, use both the C6671 Cable (supplied with all CEL-320/360 series instruments) and a CEL-6672 Cable to connect the instrument to a Centronics printer as shown.

This allows the dosimeter to recognise the printer cable during its Start Up sequence.

Only stored data can be printed, as

the microphone and printer cannot be connected to the dosimeter at the same time because they both use the same "Red Dot" connector.

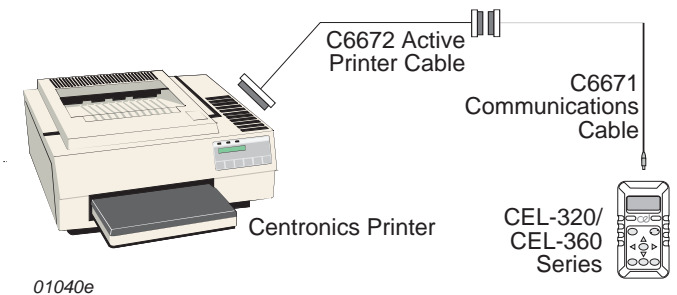

Operation	Press	Display Shows	Comments
1. Switch instrument ON			Switch on both dosimeter and printer. Switch the printer On-Line.







Operation	Press	Display Shows	Comments
2. Enable Data Recall			With the instrument stopped, display the Start Date & Time for the most recently stored run as described in Section 6.4.
3. Select Stored Run For Printing	repeat		Select Start Date & Time for required run (for example 4 June 09:10:00). Continuing to press will eventually offer PRINT READY, followed by a PRINT ALL runs option that is enabled by pressing .
4. Review Stored Data			Shows where data from the selected run is stored (store 3) and on a CEL-360 indicates the number of completed profile periods.
5. Activate Printing			When the printer is connected and switched on, the second display shows PRINT READY. If the printer is off, the display will show PRINT OFF.
6. Print Hard Copy			The display shows busy plus print messages while printing the data set from the selected run in standardised format for measurement protocol used.

7. Operation as a Sound Level Meter

In SLM mode, the instrument operates as a Type 2 sound level meter using settings made via the keypad, however, this mode cannot store data. For storage of sound level data, load the Meter setting from the setup list (Section 6.1), then operate as a dose meter (Section 6.2).

Connect the CEL-425 SLM Adaptor (as described in Section 5.1), perform an acoustic calibration as described in Section 5.2, then proceed as follows.

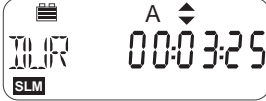
Operation	Press	Display Shows	Comments
1. Start from the final Start Up Display			The last used measurement mode will be selected.
2. If required, change Mode Repeatedly			This is operation as a SLM with the current A-weighted Fast level (L _A F) displayed. SLM mode can be selected only while a microphone is fitted.





Operation	Press	Display Shows	Comments
3. Review SLM Measurements	 several times		The display steps through all details and parameters (see Section 9.4), starting here with Linear Peak (L _{Lpk}) measurement. When  &  icons are shown on the display, the relevant menu keys may be used to change the current measurement settings.
4. Final Measurement			This completes the cycle back to first SLM display.
5. Switch OFF		Blank Screen	No operations are possible.

8. Selecting & Changing Options





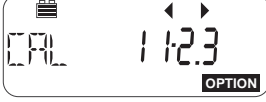

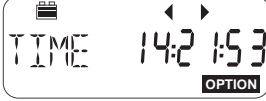

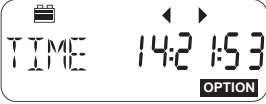

The OPTION mode accesses the part of the operating firmware that allows the following items to be checked or adjusted.

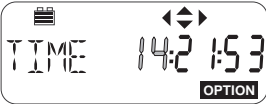
- Acoustic calibration (see Section 5.2),
- Adjustment of the calendar clock and time,
- Battery voltage, and Microphone temperature (°C),
- Communication status when the instrument is connected to a PC for use with dB10 or dB12 Soundtrack Software,
- Activate/de-activate the Run Timer commands set by dB10 and dB12 (only on a CEL-360 series).

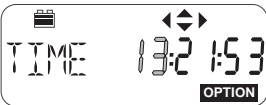
8.1 Review Options





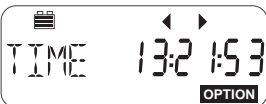



Operation	Press	Display Shows	Comments
1. Start from the Final Start Up Display			
2. Change Mode	 several times		Optional operations showing SPL for acoustic calibration, (see Section 5.2).
3. Next Option	 Re-peatedly		The display cycles through the rest of the options: Current Time, Current Date, Battery condition, Communication status, Timer status (CEL-360 series), Microphone Temperature, Erase: use this option with caution - IT DELETES ALL STORED DATA !

















8.2 Set Time & Date

Operation	Press	Display Shows	Comments
1. Select Time Option			Follow on from Step 3 in Section 8.1.
2. Enable Time Change			Cursors are enabled and the hours entry blinks to show it can be edited.
3. Change the entry	 or 		Use  and  to highlight an entry. Use  and  to change the entry.
4. Save the Changes			The new time setting is stored.

Repeat this process in the Date Option to set the date: PLEASE NOTE that the date format is dd mm yy.

8.3 Change Timer & Run Duration (CEL-360 series)

Operation	Press	Display Shows	Comments
1. Select Timer Option			Follow on from Section 8.1. Displays that are found only on CEL-360 series instruments are shown with a dashed outline ----.
2. Switch Timer ON			The Timer is now ON so that any start and stop times loaded via dB10 or dB12 will be used, UNLESS Synchronisation (SYNC) or Duration (DUR) settings are enabled as in steps 3 and 4.
3. Review Timer settings			SYNC allows synchronisation to the next profile boundary, i.e to whatever interval has been set by the PC software. Press  to enable or disable. The profile interval will also be shown.
4. Review Duration setting			DUR allows the user to select a run Duration time. When a run duration period is shown here or SYNC is ON, these take precedence over the Timer settings so that any preset start and stop times WILL NOT BE used.

Operation	Press	Display Shows	Comments
			Press  to enable, use  and  to select the following durations: Off, 5, 10, 15, 30 minutes, 1, 2, 4, 8, 10, 12, 24 hours, then confirm with  .
5. Review Repeat setting			Rept allows the user to select up to 49 repeats of the timer settings. Press  to enable, use  and  to select the number of repeats, then confirm with  .
6. Review Start/End Times			This is the First Beginning (start) time set by dB10 or dB12: dd.hh:mm. The day setting is the day of the month. When day "--" is indicated, measurement will start on the current day. Press  in either the Beg or End screen to enable/disable each timer pair. When a pair is disabled, its settings will be shown as "---".
7. Review Start/End Times			This is the First End (stop) time set by dB10 (or dB12): dd.hh:mm.
8. Review further Start/EndTimes	 Repeat	Start/End times.	The display steps through 16 sets of Start/End times.

9. Technical Information

9.1 Specification

Dosimeter/Sound Exposure Meter Standards:

IEC 61252: BS EN 61252, ANSI S1.25 - 1992 for dosimeters and sound exposure meters.

Electromagnetic and electrostatic compatibility:

The sound level at which this personal sound exposure meter conforms to clause 15 of this standard is 85 dB. The personal sound exposure meter was tested in Dose mode using 85 dB due to the duration of testing.

The instrument has no additional connector points during normal mode of operation.

N.B. When downloading data using cable no C6671, the meter conforms to the requirements for EMC emissions and immunity as specified in IEC 61000 - 61:1997, 61000 - 6 - 2:1999, 61000 - 6 - 3:1996, and 61000 - 6 - 4: 1997.

The configuration for the normal mode of operation is measurement set-up ISO 85 or ISO 90.

There is no degradation in performance or loss of functionality following the application of electrostatic discharges.

The approved configuration for the reference orientation is with the instrument secured to a nonmetallic backing material with the microphone cable secured in a horizontal figure of eight configuration starting approximately 10 cm above the instrument. The figure of eight is constructed of four even folds of the microphone cable 14 cm across. The figure of eight is then secured at each end and in the centre. The microphone housing is then secured approximately 10 cm above the centre of the figure of eight configuration. The front of the instrument is facing the principal direction of an emitter or receiver of radio-frequency electromagnetic fields.

All settings and orientations of the instrument have similar radio-frequency emissions. These radio-frequency emissions are within the specified limits of this standard.

All modes of operation and connecting device configurations have similar immunity to power and radio frequency fields.

Sound Level Meter/Integrating Sound Level Meter Standards:

ANSI S1.4 - 1983 Type S(1) for sound level meters,

IEC 60651 - 1979 : Type 2I for impulse sound level meters,

IEC 60804 - 2000 : Type 2 for integrating sound level meters.

ANSI S1.43 - 1997 for integrating sound level meters.

The sound level at which the sound level meter conforms to specifications of clause 12 of IEC 60651 is 74 dB.

The instrument has no additional connector points during normal mode of operation.

The configuration for the normal mode of operation is specified with the microphone connected via the standard preamplifier, Frequency weighting: A-weighted, Sound Pressure level, Time Constant: Fast, Measurement Range: 70 - 140 dB.

There is no degradation in performance or loss of functionality following the application of electrostatic discharges.

The approved configuration for reference orientation as viewed by the operator is with the instrument in a horizontal position facing the noise source where the receiver of the electromagnetic field replaces the noise source.

All settings and orientations of the instrument have similar radio-frequency emissions. These radio-frequency emissions are within the specified limits of this standard.

All modes of operation and connecting device configurations have similar immunity to power and radio frequency fields.

Pulse Range:

>53 dB

Measurement Ranges:

Display Range (dB)	Primary RMS range at 1 kHz	Peak
30 - 100	41 - 86	63 - 103
50 - 120	55 - 106	83 - 123
70 - 140	75 - 125 Defined from 10 dB above noise floor to a crest factor limit of 5	103 - 143

Weightings:

Frequency: A, C and linear 20Hz - 20kHz,

Time: Fast, Slow, Impulse, Peak,

Amplitude: 3, 4, 5, 6 dB exchange rates.

Clock:

Date and time can be set from the keypad.

Date and time can be set to PC time via dB10 and dB12.

Dose Measurement Timer: (CEL-360 Series only)

Use with pre-programmed delayed start and stop times, or with fixed measurement durations can be selected from the keypad.

(Start and Stop times must be programmed via dB10 and dB12.)

Dose Measurement Start/Stop Delay Timer: (CEL-360 Series only)

Delay intervals can be set only via dB10 and dB12.

Settings can be specified for up to 16 sets of start and stop times, up to 30 days ahead.

The clock indicates the time remaining before the next run starts.

Dose Measurement Elapsed Time Timer: (CEL-360 Series only)

Measurement elapsed times (run durations) can be selected from the keypad. The following options are available:

Disabled,

5, 10, 15, 30 minutes,

1, 2, 4, 8, 10, 12, 24 hours.

Under Range Indication:

1 dB below the bottom of the selected range.

Overload Indication:

140.1 dB RMS (i.e. 0.1 dB above the top of the selected range).

Maximum Peak Value:

143.0 dB Peak Linear (i.e. 3.0 dB above the top of the selected range).

Non-Linear Distortion:

Error $< \pm 1$ dB at frequencies > 10 Hz.

Stabilisation Time:

1 second.

Operating Environment:

Temperature ± 0.5 dB: -10°C to $+50^{\circ}\text{C}$,
 Atmospheric Pressure: 65 - 108 kPa,
 Humidity ± 0.5 dB: 30% - 90% (non-condensing),
 Magnetic Fields: Negligible,
 Vibration: Negligible.

Battery:

9 V, 6LF22 or equivalent for normal use, lifetime at least 35 Hours.
 I.S. Models have a minimum battery life of 30 hours.

Dimensions and Weight:

120 x 65 x 30 mm, 280 g (IS Models 380 g)
 4.8 x 2.6 x 1.2 inches, 9 oz (IS Models 120 oz)

9.2 CE Compliance

All models in the CEL-320/360 Series comply with the EMC Directive 89/336/EEC of the European Union. They have been tested according to the standard delivery schedule and comply with the following standards.

EN 50081-1 : 1992, EN 50081-2 : 1993: Generic emission standards for residential, commercial, light industry and industrial environments.

EN 50082-1 : 1992, EN 50082-2 : 1995: Generic immunity standards (for both RF fields and electrostatic discharge) for residential, commercial, light industry and industrial environments.

9.3 Default Parameter Settings

Setup	OSHA	MSHA	DOD	ACGIH	ISO85	ISO90	METER	SLM
Measurement range (dB)	70 - 140	70 - 140	70 - 140	70 - 140	70 - 140	70 - 140	50 - 120	70 - 140
Frequency weighting	A	A	A	A	A	A	A	A
Time weighting	S	S	S	S	F	F	F	S
Amplitude weighting	5	5	4	3	3	3	3	3
Peak frequency weighting	L	L	L	L	C	C	C	L
Threshold 1 (dB)	80	80	80	80	70	70	0	x

Setup	OSHA	MSHA	DOD	ACGIH	ISO85	ISO90	METER	SLM
Threshold 2 (dB)	90	90	x	x	x	x	x	x
Criterion (dB)	90	90	85	85	85	90	0	x
LN%A	L10	L10	L10	L10	L10	L10	L10	x
LN%B	L50	L50	L50	L50	L50	L50	L50	x
LN%C	L90	L90	L90	L90	L90	L90	L90	x
LN%D	L95	L95	L95	L95	L95	L95	L95	x
LN%E	L99	L99	L99	L99	L99	L99	L99	x
Profile interval	1 min	1 min	1 min	1 min	1 min	1 min	1 min	x
Profile 1	Lavg	Lavg	Lavg	Lmn	Leq	Leq	Leq	x
Profile 2	Leq	Leq	Leq	Leq	Lmx	Lmx	Lmx	x
Profile 3	Lmx	Lmx	Lmx	Lmx	Lmn	Lmn	Lmn	x
Profile 4	Lpk	Lpk	Lpk	Lpk	Lpk	Lpk	Lpk	x
Synchronise Run start in CEL-360 model	Yes	Yes	Yes	Yes	Yes	Yes	Yes	No
Allow user to change set up	No	No	No	No	No	No	Yes	Yes
Reference document	29 CFR 1910.95	30 CFR 62.0 UMHPEL	DoD Instruction 6055.12	DHHS Pub 98-126	Noise at Work Regulations 1989	Noise at Work Regulations 1989	CEL suggestion	CEL suggestion

9.4 Parameter Identities

The following time weightings and other identities may be shown.

A	A-weighting
C	C-weighting
L	Linear
S	Slow,
F	Fast,
I	Impulse,
Q	Energy conversion factor
PK	Peak,
MX	Maximum,
MN	Minimum,
EQ	Equivalent continuous level,
AV	Average level,
EP,v*	Noise dose normalised to a user selected (variable) period of hours and minutes, When the period is set to 8 hours, this will be shown a EP,d.
TWAv*	Time Weighted Average is the normalised time averaged sound pressure level with the selected frequency and time weighting that represents

Note*: This parameter can be enabled only via the dB10 or dB12 PC software.

the total Avg of a person's workplace noise exposure averaged over a user selected (variable) period of hours and minutes. This unit is specified in the USA: OSHA standard 1910-95 published in 1983.

When the period is set to 8 hours, the unit will be shown as TWA.

N Percentile sound level,
AE Sound exposure level.

10. Parts, Servicing & Warranty

10.1 Schedule of Parts

A complete Noise Dosimeter or Sound Level Meter consists of:

CEL-320/360 Noise Dosimeter as applicable (/IS if IS model),
Either: CEL-6681 (or CEL-6681/IS if I.S. instrument),

Type 2, 1/4" Electret Microphone Assembly for use as a dosimeter, complete with clip and 0.8 m captive cable,

Or: CEL-425 Sound Level Meter Adaptor with Type 2, 1/4" Electret Microphone Assembly for use as a sound level meter, (or CEL-425/IS if I.S. instrument)

CEL-6702 dB10 Control and Download software (supplied with CEL-320),

CEL-6704 dB12 Control, Download and Graphing software (supplied with CEL-360),

C6671 Communication cable to PC,

016014 Alkaline-Manganese Battery (IEC 9LF22),

060333 Users Guide, A5 multilingual instructions,

060335 Field Guide, pocket guide.

10.2 Servicing & Warranty Arrangements

To ensure its conformity with the specification, this instrument is thoroughly inspected and its accuracy verified prior to dispatch. All technical information is filed under the instrument serial number, which should, therefore, be quoted in any correspondence.

The manufacturers undertake to rectify any defect in the instrument that is directly attributable to faulty design or assembly, and which becomes apparent during the warranty period. In order to take advantage of this warranty, the instrument must be returned, carriage paid, to the manufacturer's factory or accredited agent, where necessary repairs will be carried out.

The warranty period runs for 12 months from the date of receipt of goods, with exceptions on certain specialised components supplied by other manufacturers which may be warranted for shorter or longer periods by their actual manufacturers. In all such cases, the benefit of these undertakings will be passed on to the user.

CASELLA CEL's liability is limited to items of their own manufacture, and they do not accept liability for any loss resulting from the operation or interpretation of the results from this equipment.

To obtain repair under warranty, the instrument should be packed and returned in its original packing or an equivalent either to CASELLA CEL's local agent, or in the case of U.K. domestic sales, to the CASELLA CEL Service Department at Bedford.

Please include the following information:

Instrument Type(s), Serial Number(s) and Firmware Version Number(s),

Customer name and address,

Contact name and phone number,

Details of any PC and Software involved, including Version Number(s),

Reason for returning the equipment with a detailed description of the fault,

List of any error messages that may have been displayed.

The necessary adjustments or repairs will be carried out, and the instrument returned as soon as possible.

A comprehensive Instrument Calibration Maintenance Agreement (ICMA) scheme is available to extend the initial warranty period of this instrument. At the end of the first warranty period, it is recommended that the equipment be returned to the Service and Verification Department at Bedford, where it will be inspected and entered into the ICMA scheme as required. The warranty will then be extended for the period stated on the individual schedule. Please contact your local CASELLA CEL agent for full details of this service.

After the warranty has expired (except on approved accounts) service work is undertaken against quotations, and all packing and transit costs are charged extra.

11. Intrinsically Safe Models

Models in the CEL-320/360 series are available with Intrinsic Safety approval for use in hazardous areas.

The Intrinsically Safe versions are fitted with a different firmware version but are functionally identical to the standard products. They may be connected to a personal computer for setup and download of results using the CEL-6702 or 6704 Windows software packages.

Products rating - to EEx ia IIM1, EEx ia IIC T4 II1G. Intrinsically Safe Certificate Number - Sira 05ATEX2027X.

Approved Power Supply

Only the Duracel® MN1604 alkaline type battery may be used in these meters (9 V radio battery). The use of any other battery will invalidate the intrinsically safe certification.

Battery Life

Approximately 30 hours under typical conditions.

Special instructions

The battery must be replaced only in a non-hazardous area.

The instruments must be calibrated in a non-hazardous area following the same instructions as for the standard models.

Any repairs needed for the Intrinsically Safe models must be carried out only by an approved CASELLA CEL service centre following approved written procedures.

