Detective+ IR



User Manual

M07663

July 2006
Issue 2

 **CROWCON**
Gas Detection You Can Trust

Safety information:

WARNING – Do not change the battery in a flammable atmosphere.

WARNING – Substitution of components may impair intrinsic safety.

WARNING – Read the instruction manual before use.

Instructions specific for use in hazardous areas

The following instructions apply to equipment covered by certificate number:

Sira 03ATEX2102

The following information covers all relevant points listed in clause 1.0.6 of the EHSRs of the ATEX directive.

1. The certification marking is as follows:

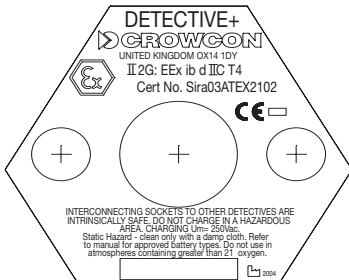

2. The equipment is Category 2G and may be used in zones 1 and 2 with flammable gases and vapours with apparatus groups IIA, IIB & IIC and with temperature classes T1, T2, T3 and T4
3. The equipment is only certified for use in ambient temperatures in the range -20°C to +50°C and should not be used outside this range
4. Use only battery pack supplied by Crowcon. Charging is only permitted in the non-hazardous area. **DO NOT CHARGE IN HAZARDOUS AREA.**
5. The equipment has not been assessed as a safety-related device (as referred to by Directive 94/9/EC Annex II, clause 1.5)

6. Repair of this equipment shall be carried out by the manufacturer or in accordance with the applicable code of practice.
7. Use only the appropriate Crowcon supplied cables for connection to the sockets at the rear of the instrument.
8. If the equipment is used in a manner other than that specified in this manual, the protection provided by this equipment may be impaired.

Area Classifications: -

Zone 1: An area classified as Zone 1 is likely to have ignitable concentrations of flammable gases, vapours or liquids present under normal operating conditions.

Zone 2: An area classified as Zone 2 is not likely to have ignitable concentrations of flammable gases, vapours or liquids present under normal operating conditions.

Crowcon Detection Instruments Ltd
2 Blacklands Way, Abingdon
OX14 1DY UK

Tel. +44 (0)1235 557700

Fax. +44 (0)1235 557749

www.crowcon.com

Email: sales@crowcon.com

© Copyright Crowcon Detection Instruments Ltd 2005. All rights are reserved. No part of the document may be photocopied, reproduced, or translated to another language without the prior written consent of Crowcon Detection Instruments Ltd.

Publication number: M07663

Second edition edition: July 2006

Contents

Quickstart Guide.....	1
I. General Description	3
II. Unpacking	5
III. Operation	7
3.1 Switch On	7
3.2 Display	8
3.3 Overrange.....	9
3.4 Cautions	10
3.5 Backlight.....	10
3.6 Alarms	10
3.7 Status Screens/Alarm Reset	10
3.8 Switching Off	11
IV. Setting Up	12
4.1 Using the Menu system	12
4.2 Configuration Options	15
4.3 Quickcal	19
V. Battery Charging.....	20
VI. Data Logging	22
VII. Interconnection Between Devices.....	23
VIII. Troubleshooting Guide.....	24
IX. Maintenance and Calibration.....	25
9.1 Recalibrating	25
9.2 Replacing the Battery Pack	25
9.3 Replacing a Sensor Module	26
9.4 User Replaceable Fuses.....	27
X. PC interface and software.....	28
XI. Limitations of Use	29
XII. Specification	30
XIII. Accessories and spares.....	31

Appendix 1 – Pumped version (optional).....	33
Appendix 2 – Front Panel Text Items	34
Appendix 3 – Sensor Limitations	36
Appendix 4 – Menu Map.....	37

Quickstart Guide

Overview

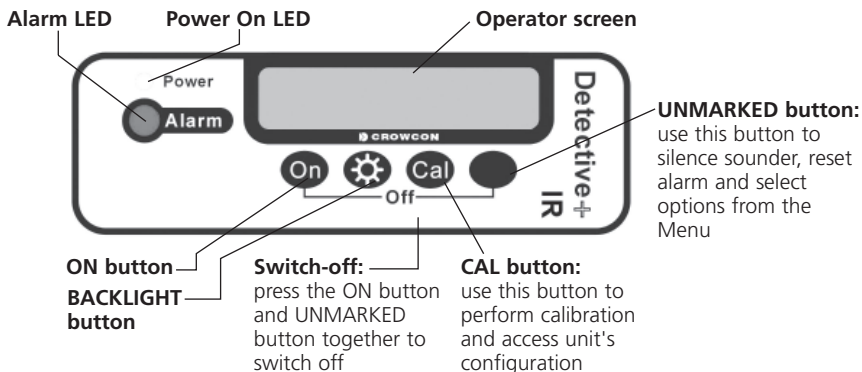

Turn ON

Press ON, press the UNMARKED button to reset alarm, green LED flashes and display will show gas levels or display 'MONITORING' if the instrument is in the GO/NO-GO mode (see SETTING UP).

In Alarm condition

Alarm sounds and the red LEDs flash. Press the UNMARKED button to silence the sounder, the red LED will continue to flash if gas is present.

Gas display mode: 'ALARM' flashes next to the hazardous gas name.

GO/NO-GO mode: display reads 'GAS HAZARD, EVACUATE AREA'.

Instantaneous and TWA alarms: Alarm is triggered when the instantaneous threshold is reached. Press the UNMARKED button to silence the sounder, the red LEDs will continue to flash if gas is present. The sounder will be triggered again if a new alarm threshold is reached.

Reset Alarm

Press the UNMARKED button.

Turn On Backlight

Press the BACKLIGHT button . It stays on for 30 minutes unless the button is pressed again. This is programmable, but is 30 minutes by default.

Battery Low

Green LED flashes quickly, the sounder frequency increases and a warning is flashed on the display. Use charger lead to charge the unit (8 hours for a full charge).

Warning: Charge the unit in a Safe area only.

Calibration/Setting up

Pressing 'CAL' and entering a password enables the instrument to be recalibrated and to change its operating modes and configuration.

I. General Description

The Crowcon Detective+ is a microprocessor controlled transportable gas detector which is capable of monitoring up to four gas types simultaneously and providing warning of hazardous levels. See Appendix 3 for notes on sensor limitations.

The built in data logging facility records gas levels of all four channels at user definable intervals for subsequent downloading to a computer. This enables a more detailed evaluation of accumulated exposure to be made than is possible with the Time Weighted Average exposure integrator, and may yield useful data about gas leak patterns and can provide essential information to an incident inquest.

The Detective+ IR unit is designed for temporary monitoring of working areas where hazardous gases may be present. For small area monitoring, while personnel are working, a single unit can be used. For protecting larger areas a number of Detective+ IR units can be interconnected, providing a protective perimeter around the work area. (See section 6 for details on how to link Detective+ IR units together).

Presence of hazardous gas levels is indicated by three high intensity red light beacons on the top of the unit and a high volume audible sounder on the underside of the unit.

The main body of the unit is constructed from fire retardant, high impact, UV stabilised ABS plastic and is protected against water and dust ingress to IP65. The unit can be supplied with either a rugged steel tripod frame or a rigid composite tripod frame with hinged legs for space-saving storage.

The sensors are located on the underside of the unit for protection, a manual aspirator can be attached for spot sampling. A pump option for automatic sampling is available. The Sealed Lead Acid battery pack within the unit provides power for up to 36 hours of continuous operation including a 30 minute period in alarm mode.

Detective+ IR is a specific version of the Detective+ utilising an infrared sensor for the detection and measurement of hydrocarbons, in place of the conventional pellistor sensor. Using infrared technology in place of pellistor technology has a number of advantages as follows:

- (a) No requirement for oxygen in the background gas i.e. operation in inert backgrounds

- (b) No damage caused by exposure to high gas concentrations
- (c) No poisoning effects
- (d) Ability to measure at % volume levels as well as %LEL
- (e) Fail safe

It must be remembered however that an infrared hydrocarbon sensor will have no response to hydrogen and is therefore unsuitable for use where hydrogen forms a significant part of any potential flammable risk. In order to ensure ready identification of Detective+ IR the membrane switch assembly is yellow in place of the normal orange and carries the name designation 'Detective+ IR'.

The infrared sensor module in Detective+ IR will be supplied with a calibration for one of four hydrocarbon species i.e. methane, propane, butane or ethylene. This calibration is factory set. Whatever the calibrated species the infrared sensor will respond to any hydrocarbon present, but with differences of response to different species. However unlike for a pellistor sensor it is not possible to assign simple correction factors, as the basic relationship between concentration and response of the detector is not linear. An infrared sensor should therefore always be calibrated for the species to be determined or a suitable target. If other specific hydrocarbon species need to be detected, please consult Crowcon as to the optimum calibration.

The infrared sensor in Detective+ IR can be supplied on one of two configurations as follows:

- **Single range %LEL**

In this case the Detective+ IR can have up to three other sensors from the standard range of toxic and oxygen sensor modules available.

- **Dual range %LEL and % volume**

In this case the sensor module has a second ribbon connector on a side-piece of PCB, and therefore takes up two display positions on Detective+ IR. This allows only two other sensor modules from the toxic and oxygen range to be used. A dual range sensor will always have both ranges calibrated for the same species, and operates in an auto-ranging mode displaying in %LEL terms with no numerical display for % volume until the level of gas exceeds 100%LEL, and in volume terms with no numerical value for %LEL when the level of gas is above 100%LEL. Note also the lower range will always display as %LEL even if the gas is detected in an inert background gas where strictly speaking the mixture cannot be explosive. The display indicates the equivalent %LEL level if the gas were in an air background.

Note: It is not possible to have a pellistor or thermal conductivity sensor in a Detective+ IR.

II. Unpacking

The Detective+ IR can be supplied with either a rigid steel tripod or a hinged composite tripod designed to be folded away for storage.

When unpacking the steel framed Detective+ IR for the first time, the three legs must be attached to the main body of the units' frame, using the bolts provided.



When unpacking the composite framed Detective+ IR for the first time, the three legs will be in the folded position.



To unfold the legs

- a) pull the leg upwards until it reaches its stop,
- b) rotate the leg downwards away from the instrument until it is pointing downwards,
- c) push the leg upwards until it firmly fits into position.

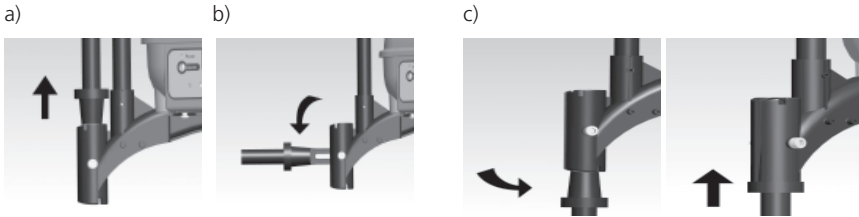

If the legs are too loose or are required to be permanently deployed, gently tighten the fixing bolt at the leg hinge.

Similarly, if the leg joint is too tight simply loosen the fixing bolt at the leg hinge, but do not loosen it too far. When packing the unit away, simply reverse the above procedure.



When the legs are in the folded position the Detective+ IR is designed to be stacked one upon the other, but it is recommended no more than three units at a time are stacked together.



Units MUST NOT be stacked in this fashion during transportation unless they are otherwise suitably secured.

When stacking units the user must be careful to comply with local health and safety regulations.

III. Operation

3.1 Switch On

Ensure the unit is in clean air. Press the 'ON' button to switch on the Detective+ IR. The instrument will display the message 'Crowcon Detective+ IR' and the serial number. The unit will test the red alarm LED, sounder and alarm beacons. Press the UNMARKED button to silence the alarm. Note: if the unit is in the presence of a hazardous gas the alarm will continue to operate. If alarms are configured to mute (see MUTE in section 4.2, Configuration Options) then the alarm will not sound and the alarm LED not flash during the switch on process.

After a short pause the display will change to 'Testing System...' and display the current battery voltage. If the current date is past a preset calibration due date, then the instrument will display 'Calibration Due'. See section 3.6 for configuration options. If there are different sensor modules in the instrument compared to when it was last used (possibly indicating sensor failure) the message 'Sensors changed?' will be displayed. If the instrument's configuration has been lost or corrupted, then the message 'Loading default data' will be displayed. With all three of these error/warning messages, the condition must be accepted by pressing the UNMARKED button, indicated on the display with the word CONTINUE above it.

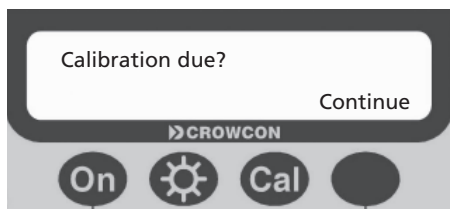

The instrument can alarm on instantaneous gas levels, and on both short and long term Time Weighted Average gas exposure levels. Note that the Time Weighted Average toxic gas exposures are reset to zero when the instrument is switched off.

When the battery reaches a low level, an operational unit will display a low battery warning. Note: if the battery is too low the unit will not switch on.

About 10 seconds after the instrument is switched on, the Detective+ IR will complete its self-tests and indicate the current gas levels.

If the instrument enters an alarm condition then the sounder will be triggered and the alarm LEDs will flash. Once the gas levels are below alarm levels (i.e. safe gas levels), the alarm warning may be switched off by pressing the UNMARKED button. If alarms are muted the red alarm LED will not flash nor will the alarm sounder sound when the instrument is in alarm - the only indication of the alarm condition will be the word 'ALARM' alternately flashing with the gas value of the channel in alarm.

3.2 Display

The information on the display is dependent on the type of sensors installed in the instrument. For each sensor module installed, the display indicates the gas concentration, the units of measurement (e.g. ppm) and the channel name (e.g. H2S). (Each sensor module contains analogue circuitry to support the sensor and a small digital memory which identifies it to the processor along with calibration data and alarm thresholds.) A quarter of the screen is reserved for each of a possible 4 gas channels. The normal mode of operation is continuous real-time gas concentration.

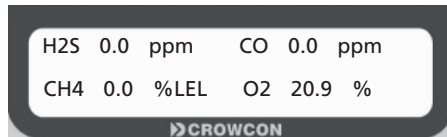

Confidence signals

The green 'power' LED flashes intermittently to give confidence to the user that all is as it should be.

Display options

The instrument may be configured into alternative display modes, by the DISPY option (see DISPY in section 4.2, Configuration Options). The ON button can be programmed to switch between modes.

The possible display modes are:

Normal: All gas values, units and names are displayed in real time

Average: The average gas reading since the instrument was switched on is displayed for toxic sensors. This is indicated by flashing 'avg' with the sensor name. Non-toxic sensors will display their normal gas level.

Off: Display reads 'MONITORING' whilst a safe condition is perceived, and flashes 'GAS HAZARD and EVACUATE AREA 'in alarm condition.

TWA Toxic: This display mode only affects toxic sensors, and is indicated by the letters 'TWA' flashing with the sensor name. The gas value displayed will be the current long-term exposure level. Non-toxic gas sensors will display their normal gas level.

Peak hold: This options affects the displayed gas value for all sensors, and is indicated by the letters 'pk' flashing with the sensor name. The highest gas level that has been read since instrument switch on will be displayed, or in the case of oxygen, the lowest level read. The peak that has been retained may be reset to the current gas level by pressing the UNMARKED button. The peak gas level will then be displayed again from then on.

In addition to the messages described above, if alarms are muted the message 'MUTED' will flash with the sensor name and units.

3.3 Overrange

If a flammable sensor's signal is out of range then the instrument may be configured, via a PC and the Portables PC software, to either flash the relevant numbers on the display, or to display a message of the form 'SENSOR FAILURE' and the name of the failed sensor. The alarm sounder will activate. This type of error could indicate a high gas level or sensor failure. Calibration should be checked after such a warning.

3.4 Cautions

Sensors may be adversely affected by exposure to silicones, lead compounds, high levels of hydrogen sulphide and chlorine, and some industrial solvents.

3.5 Backlight

In low ambient light conditions, the backlight can be activated to illuminate the display by pressing the BACKLIGHT button . To switch off the backlight press the BACKLIGHT button again, or it will turn off automatically after a configurable timeout period of 10, 20 or 30 minutes. Alternatively, the backlight may be configured to remain on permanently, or to never timeout once switched on. (See LIGHT in section 4.2, Configuration Options). In an alarm condition, the backlight is automatically turned on.

3.6 Alarms

When the Detective+ IR encounters an alarm condition the red lights flash, the beacons activate and the sounder emits a loud, fast bleep. Where permitted instantaneous toxic gas alarms may be accepted by pressing the UNMARKED button. In this case, the sounder is silenced but the red lights continue to flash. With instantaneous alarms, the word 'ALARM' will flash next to the gas name. Time Weighted Average exposure limit alarms will flash the whole display with the warning. All instantaneous alarm types are latching which means that they may only be reset by pressing the UNMARKED button when the gas hazard has passed. If set up for time weighted average (TWA) alarms, the Detective+ IR triggers a non-resettable alarm if a short term (normally 15 minute) or long term (8 hour) exposure level is reached. Both TWA alarm types may only be reset when the average exposure has fallen below threshold levels. (See Configuring the instrument with *Portables PC software* on setting these levels).

3.7 Status Screens/Alarm Reset

The UNMARKED button has two functions: to reset alarms (see 3.6 above) or to display a series of status screens. To view the status screens press the UNMARKED button when the instrument is not in an alarm condition.

The series of status screens show the following information in sequence. Press the UNMARKED button to move onto the next screen, and eventually back to the main instrument display of gas levels. If the button is not pressed for 20 seconds the instrument will 'timeout' and return to the main gas reading screen.

The date, current time, and the time elapsed since instrument switch on is displayed.

Serial number and calibration due date is displayed.

Alarm 1 levels are shown for all sensors.

Short-term exposure levels are displayed for toxic sensors.

Long-term exposure levels are displayed for toxic sensors.

Currently selected user and site are displayed.

3.8 Switching Off

Before turning the unit OFF, purge it with air, until all channels read zero and Oxygen reads 20.9%, after this turn it of. The DETECTIVE+ is turned OFF by simultaneously pressing the ON button and the UNMARKED button simultaneously and holding them down for about half a second. This prevents accidental switch off through knocking the keypad. This 'OFF' mode may be disabled via the Menu or using the Portables PC software.

If the unit is not purged and has gas inside, the next time it is turned on and zeroed, it will zero in gas presence. In this case, after the gas is purged, the detector will give negative readings. If this happens, purge the unit until it stabilize at a negative reading, then do a manual zero according to section 4.2.

IV. Setting Up

The Detective+ IR has been designed to display as much or as little information to the user as is required by the controller of the equipment. On the one hand it is a four channel measuring instrument with continuous readout, on the other, a basic alarm only detector with status display and no way of switching it off. This section describes how to tailor the instrument to the application via the front panel buttons. The section on Configuring the instrument with Portables PC details other adjustments that may be made to the instrument configuration via a PC and the Portable PC software.

4.1 Using the Menu system

To access the SETUP menu press 'CAL' button. The screen will display the following:

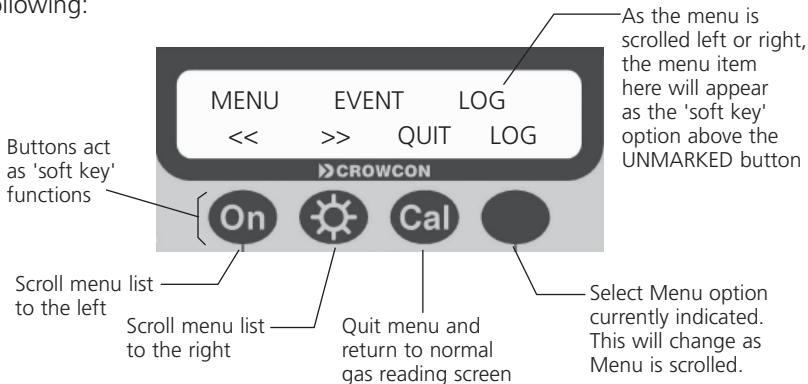

The four buttons have above them a symbol or word: these are the 'soft key' functions currently assigned to that particular key. Use the ON and BACKLIGHT buttons to scroll left and right, the CAL button to quit the menu system and the UNMARKED button to select a menu option. View the road map on page 37 for details of Detective+ IR configuration menu system

The options available are:

- MENU** This selects the configuration menu. It is password protected, and described below
- EVENT** This marks an event in the data log. There is no menu beneath this option.
- LOG** This selects the log menu, described below.

How to enter the configuration Menu

Use the scroll buttons to select the MENU item and press the UNMARKED button. The screen will display 'Password?' Press the buttons in the following sequence within 5 seconds to enter the default password: ON, BACKLIGHT, CAL and UNMARKED. This password can be changed via a PC and the SetPortable software.



How to change an option

To change an option, use the first two keys, labelled with the << and >> symbols, to change the current selection, and the third key (labelled QUIT) to finish changing the selection. If the QUIT key is pressed and the parameter has been modified then the user is prompted with a save changes message. Two keys are soft key function labelled, one with YES and one with NO. Press the desired button.

For example, to configure the start-up option, from the configuration Menu follow the steps below:

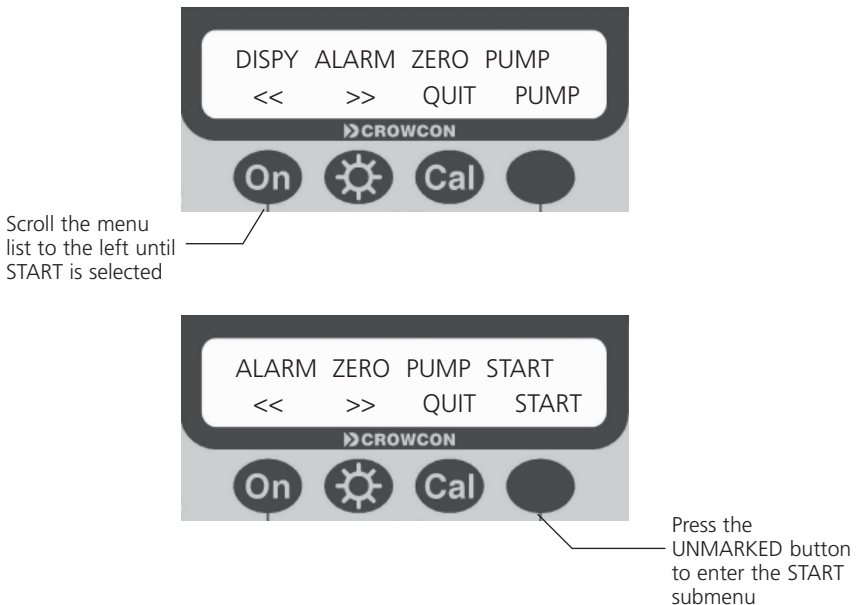

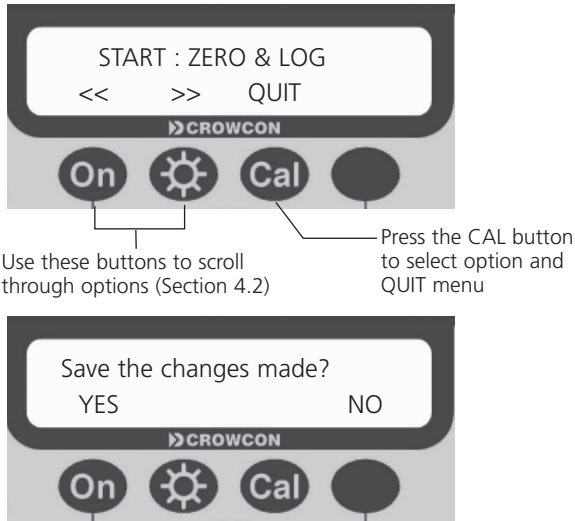

Press the first button to save the change and move the menu back up a level, and the last key to leave the selection as it was (unchanged) and move back up a level.

The menu system has timeouts on all operations. If no keys are pressed within about 20 seconds the system steps back one level at a time. Changes that have been accepted by pressing YES to the save changes prompt are retained. Any change that has not been explicitly saved will be lost.

The following parameters are modifiable via the instrument front panel buttons, and are displayed on the screen in the following order:

ZERO FLAMM LEVEL PUMP CALIB DISPY ALARM START BUTTN TIME
OFF LIGHT

Details of each parameters are given in section 4.2, a road map of the menu system can be found on page 37.

4.2 Configuration Options

LIGHT:

Configures the backlight timeout option to be *NEVER TIMEOUT*, *10 MINS.*, *20 MINS.*, *30 MINS.*, or *ALWAYS ON*. Whatever option is selected, the backlight will always come on when the instrument is in alarm.

DISPY

Display mode. Configures the instrument display mode, with one of the following options: *Normal*, *Average*, *Off*, *TWA Toxic*, *Peak Hold*. These are described in the section III Operation. **Note:** the action of the BUTTN option below.

ALARM

Alarm mode. User can select one of the following: *ALL ACTIVE*, *TWA ONLY*, *INSTANT*.

Within this option, the instrument may be set up to acknowledge different toxic gas alarm types. Instantaneous mode (INSTANT) sets the instrument to alarm as soon as threshold toxic gas level is reached.

TWA ONLY will cause the instrument to ignore temporary excursions above instantaneous alarm thresholds but to go into alarm instead when the SHORT TERM or LONG TERM exposure levels have been reached. ALL ACTIVE enables both TWA and instantaneous alarm types but allows the user to silence instantaneous alarms (see section III Operation).

'ZERO'

When this option is selected, the instrument will give the prompt 'ZERO ALL?' Only if you are sure that the instrument is in clean air and all sensors have settled down to a steady output should YES be pressed. The Detective+ IR then calculates offset correction and gain factors necessary to make toxic and flammable gas channels read zero and oxygen channels read 20.9%. Following a successful zeroing, there is the option to END the set up and return to monitoring, or to CONT to continue with setting up.

PUMP

Turns the pump on and off. Options are GO and STOP.

START

Selects functions to be enabled at start up (instrument switch on). Options are: *NOTHING*, *ZERO*, *LOG*, *ZERO & LOG*.

ZERO enables the option of zeroing the sensors at start, as per the zero all option above – the prompt to zero the sensor will appear several seconds after start up (to give the sensors time to settle) and will timeout (without performing a zero) if the YES button is not pressed within about 5 seconds.

LOG enables data logging at start up, and ZERO & LOG enables both zero and data logging at start up. Select NOTHING to disable zero and logging at start up.

BUTTN

The ON button can be programmed to perform various functions when the instrument is in normal gas measurement mode. The options available are: *NOTHING, PUMP, PEAK, TWA TOXIC, AVERAGE, NORMAL.*

NOTHING means all special functions on the button are disabled.

PUMP allows the pump to be switched off and on without having to enter the menu system to perform this action.

PEAK, TWA TOXIC and AVERAGE are as per the DISPY functions. Pressing the button when one of these options is selected will toggle the display mode between that set on the button and that set in the DISPY setting.

NORMAL serves a similar function. If the DISPY mode has been set to something other than NORMAL then NORMAL allows the display mode to be toggled from that set in the DISPY option to the normal gas display. **Note:** these display functions have no effect if the DISPY mode is set to OFF, and that the instrument will always start up in the display mode set by the DISPY function. If the MUTE function is enabled then a SILENT ALARMS option will also appear as one of the possible selections in the BUTTN menu. This option allows the programmable button to toggle the MUTE feature between SILENT ALARMS and AUDIBLE ALARMS. Note that when SILENT ALARMS is selected no audible siren will sound when the instrument is in alarm, nor will the alarm light flash. There will be a visual indication of the alarm condition on the instrument's display. When the programmable button is pressed the instrument will issue a double bleep sound as an audible confirmation that a feature has been selected or de-selected.

FLAMM

This is not functional in Detective+ IR.

CALIB

This allows re-calibration of the instrument, which must first have been Zeroed in clean air. You will need a calibration flow plate, which is included as standard with the Detective+ IR and a supply of Crowcon calibration gas (see section VIII Maintenance and Calibration). The top line now displays one of the instrument's gas channels. This display will look like:

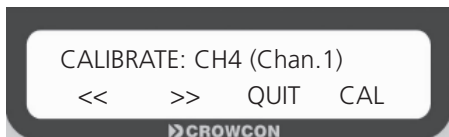

Use the first two keys to select the required gas. Press QUIT to move back up a menu level, or CAL to select the gas to calibrate. The display will now change to:

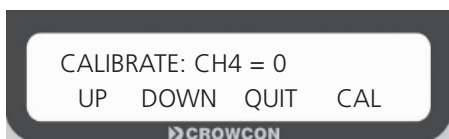

The actual gas reading is displayed on the top line, and should go up when the relevant TEST GAS is aspirated over the sensors. When the reading has stabilised use the UP and DOWN keys to make the reading match the known test gas concentration. Now press CAL to actually calibrate the instrument's gain. QUIT can be pressed to abandon the calibration. If the instrument is calibrated, it will either respond with CAL SUCCESSFUL or CAL FAILED. If the calibration failed the instrument's gain is not changed, and means that either the gas concentration was not equal to the value set (check both and repeat) or that the sensor has deteriorated with use (see Maintenance and Calibration for sensor replacement).

When a calibration is being performed, replace the integral flow plate with the calibration flow plate so the gas is not being sampled by the pump.

TIME

Selecting this will give a display of the form:

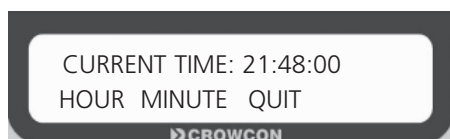

Press the key labelled HOUR to increment the hours and the key labelled MINUTE to increment the minutes until the correct current time is displayed

OFF

Two options: OFF ENABLED, OFF DISABLED. Determines whether the instrument can be switched off.

MUTE

If the mute function is enabled (which can only be done via SetPortable, see section IX. PC interface and software) then a MUTE option will appear within the menu system. This option can be selected as either SILENT ALARMS or AUDIBLE ALARMS. If SILENT ALARMS is selected then the word MUTED will flash on the main display with the gas units and name, no audible alarm will sound when an alarm is triggered, nor will the alarm LED will flash. There will be a visual indication of the alarm condition on the instrument's display. Note: this option will be ignored when the instrument's display mode is selected as OFF.

LEVEL

This option displays and allows modification of alarm 1 for flammable L.E.L. channels. Use the two keys labelled on the display as UP and DOWN to adjust this alarm level between to the required value.

Note: Crowcon does not generally recommend that alarm levels be set to a level that is less than 5% of the sensor's range because of the possibility of spurious alarms being triggered.

LOG MENU

The LOG MENU acts similarly to the MENU system just described. Options are: *START* or *STOP*. One of these two options is displayed depending on the current state of the data logger. Press *START* to turn data logging on, and *STOP* to turn logging off.

USER

Allows selection of a user name, which is used in the data log (see later). The act of changing the user is an event which is logged by the data logger.

SITE

As user, but site location.

4.3 Quickcal

The instrument has the ability to perform a 'quick calibration' of four gas channels: CH₄; CO; H₂S and O₂ in 'one go'. The system prompts the user through the procedure. Before QuickCal is initiated, the instrument should have been zeroed. Now follow this procedure:

Press both of the middle 2 buttons, and hold them down for 5-7 seconds. The instrument will announce that the Quick Calibration has been initiated, and remind the user that the instrument should have been zeroed before this procedure is invoked.

The instrument will now alternately flash the gas concentrations it is expecting to be applied and the prompt CALIBRATE ALL INPUTS, with the two outer keys labelled with YES and NO. Pressing YES moves on in the QuickCal sequence, NO abandons the QuickCal and the instrument returns to the normal gas monitoring screen.

The instrument will now issue the prompt 'Is gas on sensors?' with the two outer keys labelled YES and NO as before. Ensure the correct test gas is applied to the instrument, and press YES. Pressing NO returns the instrument to the normal gas monitoring display.

If YES is pressed the display will change to SENSORS SETTLING, with a line of dots appearing on the bottom line of the display to indicate the instrument is working. The instrument will now wait until there appears to be a good steady flow of gas, and then the calibration will be performed. If the instrument perceives that the gas level is not steady then the message 'Gas not stable!' will be displayed and the calibration aborted.

If all channels are successfully calibrated the instrument will display the message 'Calibration successful', otherwise the message 'Calibration failed!' with the list of gases that failed the calibration displayed.

When performing a calibration with a gas from a pressurised source, the sampling flow plate must be removed and replaced with a calibration flow plate.

V. Battery Charging

The built in Sealed Lead Acid battery pack has sufficient capacity to power the instrument for over 36 hours (including a 30 minute period in the Alarm condition). The unit incorporates a two stage charging circuit that is powered from the local main supply, using the appropriate Crowcon charging lead that is supplied with the instrument.

The charging input socket is located at the rear of the unit, and is protected by a steel cover, which is held in place by a retaining grub screw.

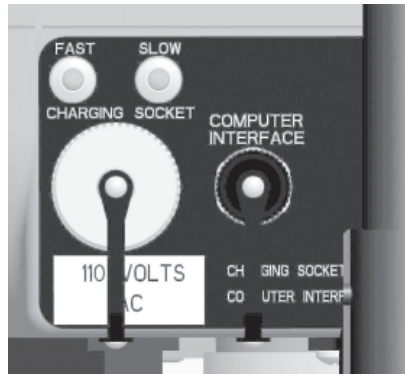

UNDER NO CIRCUMSTANCES MUST THE COVER BE REMOVED OR THE CHARGING LEAD BE CONNECTED TO THE UNIT WHEN IT IS LOCATED IN A HAZARDOUS AREA.

Depending on the factory setting, the Detective+ IR charger input rating which will be either:-

250 V AC, 150 mA, 50-60 Hz or 110 V AC, 300 mA, 50-60 Hz.

This is indicated on the yellow rating label situated immediately below the charging socket. Before connecting the unit, ensure that the locally available supply is suitable for the indicated rating.

If the supplied charging lead is not fitted with a plug to connect to the local mains supply, ensure that a suitably trained person fits the appropriate mains plug to the lead, making sure to comply with all relevant local wiring and health and safety regulations.

To begin charging, in a safe area, loosen the grub screw on the charging socket cover and remove the cover. Attach the supplied charging lead to the socket

ensuring that it is firmly secure. Plug the other end of the lead to the local supply and switch on. Initially the red LED will illuminate indicating that the unit is "Fast" charging the battery. When the battery reaches about 90% charged, the unit will switch to "Slow" charging and illuminate the green LED. If the battery is already charged before the power is switched on, the unit will go straight to its "Slow" charge mode and illuminate the green LED immediately. The "Slow" charging mode can be used to maintain a "Top-up" charge on the unit when it is not being used. Before use, when charging is complete, the charging socket cover must be replaced and secured by tightening the grub screw provided.

The time taken to charge the battery will depend upon the state of discharge of the cell and its capacity. Generally speaking it should take less than 8 hours to fully charge a standard 7.2 Ahr battery, but if fitted with higher capacity cells the charging will take proportionally longer. It is recommended that when a unit has remained unused for some time (weeks) that it is charged before being used to ensure that a sufficient capacity is available.

The unit should never be left in a fully discharged state for any length of time (more than a week) as this will significantly impact on the life of the battery pack. It is not necessary to wait until the "Low Battery" warning appears on the display to begin recharging the battery, it is recommended that the unit is put on recharge immediately after any significant use to ensure the unit is ready for when it is next required.

If the operating life of the battery begins to reduce significantly, or if the time taken to charge the battery begins to increase, then it is recommended that the battery pack be replaced, refer to your service support for details. Refer to section IX for instructions on replacing the Battery pack. Use only the Crowcon supplied parts, see spares list, when replacing the battery pack.

Note: The user must comply with local environmental regulations when disposing of Detective+ IR battery packs.

VI. Data Logging

The data logging aspect of the instrument can be configured to be active when the instrument is switched on by the START menu option. Additionally, the instrument records events (such as alarms) and an event will cause the logger to be switched on.

Data is logged for all gas channels at a rate set by the log period, which is configurable via *Portables PC software*. The standard logging interval is 1 minute. For each channel, the maximum level (minimum in the case of oxygen) is recorded since the last reading was taken and stored in the log. Thus, even if the log period is set to 10 minutes (for example) and a brief gas hazard occurs, it will not be missed by the logger. Logged data is retained in battery-backed memory when the instrument is turned off. When the memory is filled, the new data over-writes the oldest.

A log is extracted from the instrument and saved as a file on the computer via the Portables PC software, which also allows viewing of the logged data on the PC.

The instrument notes the following events in the log along with a note of the channel the event is associated with (if appropriate):

- Log switched on – either from front panel or by event trigger
- Log switch off – either front panel or by instrument switch off
- Sensor channel overrange
- Instantaneous alarm 1
- Instantaneous alarm 2
- Instantaneous alarm 3
- Short term exposure alarm
- Long term exposure alarm
- User triggered event (from the instrument front panel)
- Change of user (from the front panel)
- Change of site (from the front panel)

The instrument is capable of storing just over 6300 data logs for all channels. Events take the space of 2 logs.

VII. Interconnection Between Devices

When multiple units are needed to secure a large area or perimeter around a work site, the Detective+ IR units can be connected together to provide indication of hazardous gas level alarms on all units, even when the detecting unit may be out of sight/sound of some of the working party.

Two connector sockets are provided at the rear of each Detective+ IR unit to permit this mode of operation. Using only suitable Crowcon supplied cables, connect each Detective+ IR to its two neighbours in a "Daisy Chain" configuration.



When a unit in such a system detects a gas alarm it will initiate an alarm in all units. The unit detecting the alarm will indicate the alarm in the normal manner as described in the preceding sections. The other units in the system will indicate an alarm with the beacon lights at the top of the unit flashing at a much slower rate. This permits the user(s) to determine at which point the gas alarm is occurring.

Up to twelve Detective+ IR units can be connected in this manner with a maximum cable length of 100 m between adjacent units.

VIII. Troubleshooting Guide

SYMPTOM	DIAGNOSIS	REMEDY/CHECK
Does not switch on	Battery flat	Recharge battery
Does not switch off	OFF disabled	Alter configuration*
No audible tick	Tick disabled	Alter configuration*
Alarm signals, no gas	Alarm latched	Reset with UNMARKED button
Flashing red alarm, Sounder silent	INST toxic alarm accepted	Reset if possible, check configuration*
Gas reading, no gas	Zero drifted	Zero instrument*
Unstable/inaccurate reading	Sensor failed	Recalibrate or replace sensor*
Loading Defaults message on display screen	Back up battery is discharged	Recharge unit then re-configure and recalibrate.
PC Interface Not Working	Blown fuse, incorrect software/PC Portables version	Check Fuses F8 and F9 (see maintenance Section for details) update to latest software version
Unit Not Charging	Blown fuse, dead battery, incorrect input voltage	Check Fuses F3 and F4 (see maintenance Section for details) replace battery, check input voltage

*See *SETTING UP* or *CONFIGURING THE INSTRUMENT VIA SETPORTABLE*

** see *MAINTENANCE AND CALIBRATION*

IX. Maintenance and Calibration

Crowcon recommends monthly gas response checks and a recalibration interval of 6 months. The IR sensor in the Detective + IR does not respond to hydrogen but does to most hydrocarbons and will be calibrated for a specific gas, typically methane.

9.1 Recalibrating

Read about the 'CALIBRATE?' option in SETTING UP (CALIB) and the CALIBRATE functions in Portables PC as either method may be used to adjust gain values, but a knowledge of both is helpful.

First, remove the pumped flow plate from the instrument, if fitted. Then, zero the unit in clean air. Place the calibration flow plate over the sensors and secure with the half-turn fasteners.

Starting with flammable gases and moving on to toxic, connect the appropriate cylinder of test gas to the inlet of the calibration flow plate. The correct calibration flow rate is 0.5 litres per minute. Most Crowcon gas bottles use a fixed flow rate regulator which automatically provides the correct flow rate.

Wait until the reading has stabilised on the Detective+ IR display before resetting the reading to the correct level. Now shut off the valve and disconnect the supply of test gas. Remove the calibration flow plate and allow the sensor to reset to zero.

9.2 Replacing the Battery Pack

The battery pack should only be replaced by a suitable trained and qualified Service Engineer. Be careful to retain all nuts, bolts and washers during disassembly. The procedure for replacing the battery pack is as follows.

- 1) Remove the two security screws on top of the lamp cover on the top side of the unit, and remove the lamp cover.
- 2) Remove the centre fixing bolt exposed when the lamp cover is removed.
- 3) Carefully remove the top half of the unit enclosure, disconnecting the attached cable at the Main PCB.
- 4) Remove each cable connection to the Main PCB, making careful note of where each is attached. Remove the Earth connections from the stud at the rear of the PCB mounting chassis plate.

- 5) Remove the four retaining screws from the Main PCB mounting chassis plate where it is secured to the lower half of the casing on either side.
- 6) Remove the Main PCB and its mounting chassis plate, exposing the battery pack.
- 7) Remove the battery from the base of the unit and substitute it with the replacement battery pack. Ensure that the Battery pack is located within the rectangular retaining features of the lower case moulding.
- 8) Replace the PCB mounting chassis and fix to the lower case. Re-attach the Earth connections to the Earth stud at the rear of the PCB mounting chassis plate, and re-fit the cable connectors to their correct positions on the Main PCB
- 9) Refit the cable lead from the top half of the case to the Main PCB and carefully replace the top half of the case onto the lower half of the case. Ensure that the integrity of the edge seal is maintained.
- 10) Replace the centre fixing bolt on top of the unit, replace and secure the lamp cover.

Note: The user must comply with local environmental regulations when disposing of battery packs.

9.3 Replacing a Sensor Module

- 1) Remove the two security screws on top of the lamp cover on the top side of the unit, and remove the lamp cover.
- 2) Remove the centre fixing bolt exposed when the lamp cover is removed.
- 3) Carefully remove the top half of the unit enclosure, disconnecting the attached cable at the Main PCB.
- 4) Remove the 5 pin molex JP3 labelled BATT connecting the battery to the main board.
- 5) Identify the sensor module to be replaced and disconnect the flexible pcb from it by lifting the shroud from the header and gently pulling on the tail.
- 6) Remove the two Pozi-drive screws and the old sensor module.
- 7) Remove the old gasket/membrane assembly.
- 8) Fit the new components according to a reverse of the above, ensuring that the shroud is pushed home over the header to grip the flexible pcb tail securely. Replace the LED lead onto the main board connected JP5.

- 9) Replace the battery lead onto the main board connector JP3.
- 10) Refit the cable lead from the top half of the case to the Main PCB and carefully replace the top half of the case onto the lower half of the case. Ensure that the integrity of the edge seal is maintained.
- 11) Replace the centre fixing bolt on top of the unit, replace and secure the lamp cover.

Detective sensor modules are supplied precalibrated from the Crowcon factory and will identify themselves to the instrument when it is switched on. It is advisable to check the response to test gas to ensure that no damage has occurred in transit and that installation has been carried out successfully.

9.4 User Replaceable Fuses

There are four fuses on the Main PCB within the Detective+ IR which can be replaced by the user if necessary (Refer to figure below). If so, the fuses MUST be replaced by equivalent parts meeting the following specifications. All of the fuses are Quick Blow, Ceramic, 20 mm x 5 mm cartridge type fuses. The ratings of the user replaceable fuses are :

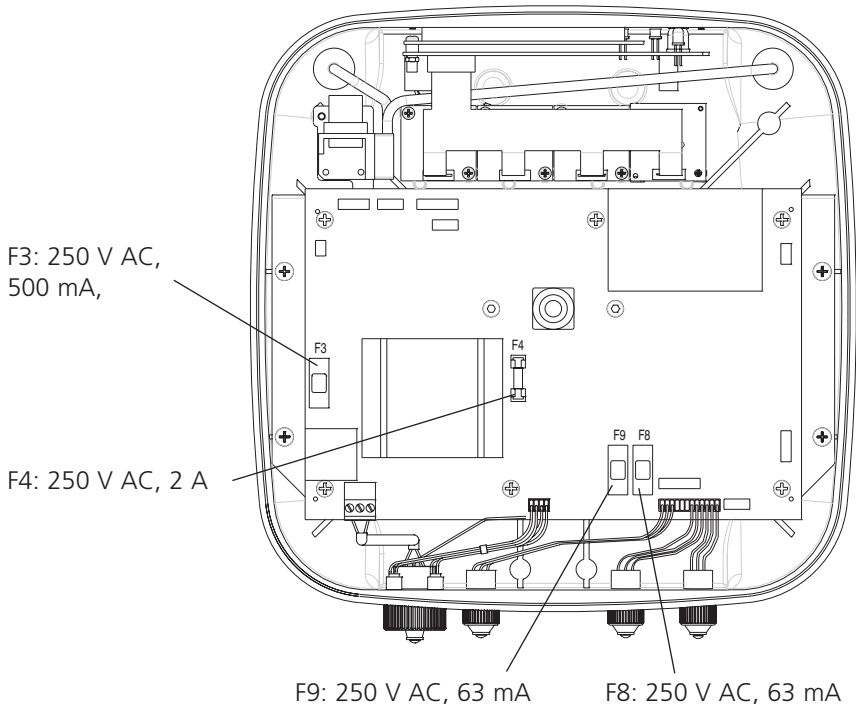

X. PC interface and software

The Detective+ IR can be connected to a PC using the serial communications link, to configure, calibrate and monitor the unit. To do this the user will require the Computer Interface Lead and an installed copy of the Crowcon Portables PC software, version 1V1.5 or later. The Computer Interface Lead, Part Number E07394, and Portables PC Software, Part Number C01832, are available from Crowcon or any of their approved agents. For other available accessories, refer to section XIII.

Attach the Interface lead to the Detective+ IR at the "Computer Interface" socket supplied at the rear of the unit. Attach the other end of the Interface Lead to an available serial RS232 communications port on the PC.

With the Detective+ IR switched on, open the Portables PC application and, using either the Wizard, or the Engineers Form, select "Detective+ IR" and upload the configuration. For more information on using the Crowcon Portables PC software, refer to the interactive help file installed with the software.

XI. Limitations of Use

	LONG TERM STORAGE LIMITS		OPERATING LIMITS	
	min	max	min	max
TEMPERATURE	0°C	20°C	-10°C	50°C
PRESSURE	900 mbar	1100 mbar	900 mbar	3 bar
HUMIDITY (non condensing)	15%RH	90%RH	0%RH	90%RH

XII. Specification

Dimensions	Rigid frame: 640 h x 482 w x 457 d mm (25.2 x 19 x 18 inches) Folding frame: 640 h x 453 w x 454 d mm (25.2 x 17.8 x 18 inches)
Weight	8 kg (17.6 lbs)
Housing, degree of protection	IP65
Operating temperature	-20°C to +50°C (-4°F to 122°F).
Humidity	0 – 95% RH non condensing.
Display	2 lines of 24 characters, dot matrix high contrast LCD
Battery	6 V, 7.2 Ah Sealed lead acid battery pack
Battery charging	Built-in battery charging circuit, dual rate Input 100 or 250 V AC (Safe Area operation only) Typical charge time: 8 hours
Response time (typical)	Methane 20 s, Oxygen 10 s, Typical toxic gas 20 s.
Explosion protection	Intrinsically Safe
ATEX	Essential Health and Safety Requirement, clause 15.9
Safety certificate no.	Sira 03ATEX2102

Approvals

Europe:	ATEX II 2G EEx ibd IIC T4 IECEx (pending)
USA:	UL 913 (pending)
Canada:	CSA C22.2 (pending)

Standards

Europe:	EN50014, EN50020, EN61010-1
---------	-----------------------------

XIII. Accessories and spares

Accessories list

Description	Crowcon part number
Aspirator assembly and lead	C01685
Extra Aspirator Hose	M04032
Sewermans Baffle Plate	C01325
Computer Interface Lead	E07394
Portables PC Interface Software	C01832
Water Trap	C011033
Interconnection Cable 10 m	E07397
15 m	1965 / 1
20 m	1302 / 1
25 m	637 / 2
30 m	1302 / 2
50 m	637 / 1
100 m	1420 / 1

Spares list

Description	Crowcon part number
General Spares	
Main PCB	S01326
Main PCB Chassis	M01893
Display PCB and Loom	S01345
Battery Pack, 7.2 Ahr	S011951
Case (Upper)	M04905
Case (Lower)	M04906
Case Top Retaining Bolt	M03723
Keypad Label (Detective+)	E01940
Keypad Label (Detective+ IR)	E01924
Keypad Protective Film	M05478
IS Sounder	E01956
Lamp Cluster	E01955
Lamp Connection Lead	E07324
Lamp Cover	M04907
Lamp Cover Retaining Bolts	M03336
Charging Socket	E07391
Charging Socket Cover	M01540
Charging Socket Cover Gasket	M04383
Charging Socket Grub Screw	M03334
Charging Lead	E07390
Interface Socket	E07392
Interface Socket Cover	M01543
Interface Socket Cover Gasket	M04384

Retaining Strap for Socket Covers	M04398
Retaining Strap Fastener	M03405

Rigid Steel Tripod Variant

Frame Leg Assembly – 3 per set	M01754
Frame Support Plate	M01755
Frame Handle Assembly	M01756

Fold-away Composite Tripod Variant

Leg Assembly	S011970
Leg Hinge Bolt	M03670
Frame Support Bracket	M04901
Handle	M01890
Handle Grip	M04904
Top Retainer	M04902
Top Retainer Fixing Screw	M03801

Refer to the current price list for an up-to-date list of available spare parts, including replacement or alternative sensors, and their relevant stock numbers.

Appendix 1 – Pumped version (optional)

The internal pump, when used in conjunction with the external flow plate and sampling tube, enables the Detective+ IR to monitor inaccessible atmospheres. It offers a consistent flowrate and is not fatigued, unlike the manual hand bulb. Pumped units are fitted with a water trap which requires periodical inspection and emptying.

The pump mode may be defined within the calibration menu to be either pump GO or STOP. This enables the instrument to be used in either pumped or diffusion monitoring mode. See the SETTING UP section above for details on how this can be configured. Additionally, it is possible to control the pump via the programmable button as described in section 4.2, Configuration Options.

If the STOP pump mode is selected the pump will not run, and the flow plate and tubing must be removed to enable gas to enter the sensors by diffusion.

If the GO pump mode is selected the pump will now run and the flow plate should now be fitted. Ensure that flexible tubing connects between the pump inlet nozzle on the side of the instrument and the outlet ('BULB' side) of the flow plate. The sample tube should be connected to the 'INLET' side of the flow plate.

The pump mode is remembered while the instrument is switched off.

On increasing the length of the sample tube, the response time will be affected and some gases may be absorbed, e.g. chlorine. Add approximately 1.5 seconds per metre of sample tube for gas to reach the instrument (4 mm I.D. tube). Be careful not to suck water or dust into the instrument, and avoid kinking the sample tube. If the flow is blocked for any reason, the pump is automatically stopped, and the warning message 'PUMP FLOW FAIL' appears on the display. Attend to the blockage and then restart the pump by pressing the right hand button. The pump draws power from the Detective+ IR battery pack and so reduces the operating time between recharge by approximately 5 hours before the full stop.

When the instrument is being calibrated from a pressurised gas source, the pump flow plate should be removed and replaced with the calibration flow plate, so calibration gas is not drawn into the pump.

Appendix 2 – Front Panel Text Items

This Appendix lists all the possible values the front-panel configuration parameters may take.

Top level configuration items – accessible by pressing the CAL button:

Text	Description
MENU	Enter configuration menu, passworded
LOG	Enter data logging menu
ZERO*	Zero all channels
EVENT	Mark event in the data log

**Only present at this level if so selected via SetPortable.*

MENU level configuration items:

Text	Description/Options
ALARM	Select alarm mode: INSTANT, ALL ACTIVE, TWA ONLY
BUTTN	Select programmable button function: NOTHING, NORMAL, AVERAGE, TWA TOXIC, PEAK HOLD, PUMP, SILENT ALARMS
CALIB	Calibrate selected channel
DISPY	Select display mode: NORMAL, AVERAGE, OFF, TWA TOXIC, PEAK HOLD
FLAMM	Select flammable correction factor: NO CORRECTION, ...
LEVEL	Allows setting of alarms
LIGHT	Select backlight timeout: ALWAYS ON, NO TIMEOUT, 10, 20 or 30 MINUTE TIMEOUT
MUTE	Select SILENT ALARMS or AUDIBLE ALARMS
OFF	Select instrument switch off mode :OFF ENABLED, OFF DISABLED
PUMP	Pump on or off: GO, STOP
START	Start up options: NOTHING, LOG, ZERO, ZERO & LOG
TIME	Allows edit of instrument time (hours and minutes)
ZERO*	Zero all channels

**Only if not selected to be at the higher level (via SetPortable).*

***Only if MUTE function enabled (via SetPortable).*

LOG level configuration items:

Text	Description/Options
------	---------------------

START*	Start data logging
--------	--------------------

STOP**	Stop data logging
--------	-------------------

SITE	Select site: Site 1, Site 2, Or string programmed via SetPortable
------	--

USER	Select user: User 1, User 2, ...Or string programmed via SetPortable
------	--

**This option is only present if the logger is currently stopped.*

***This option is only present if the logger is currently on.*

Appendix 3 – Sensor Limitations

The flammable IR sensor in the Detective+ IR responds to flammable hydrocarbons, but not to non-hydrocarbon flammable gases, such as hydrogen.

The instrument is not suitable for use in ambient temperatures above 50°C and electrochemical toxic gas sensors may be degraded at these temperatures.

Water should not be allowed to collect on the sensors as this may impede gas diffusion. Use with care in wet or humid environments where water may condense on the sensors, and check response after use.

Persistent exposure to high levels of toxic gas can shorten the life of toxic sensors. Toxic sensors may also be cross-sensitive to gases other than their specific target gas, and hence the presence of other gases may cause the sensor to respond. If unsure, contact Crowcon or your local agent.

Use of high power radio transmitters in close proximity to the instrument may exceed RFI immunity levels and cause erroneous indications. If such problems are experienced, remove antennae to a reasonable distance from the instrument (e.g. 30 cm).

Appendix 4 - Menu Map

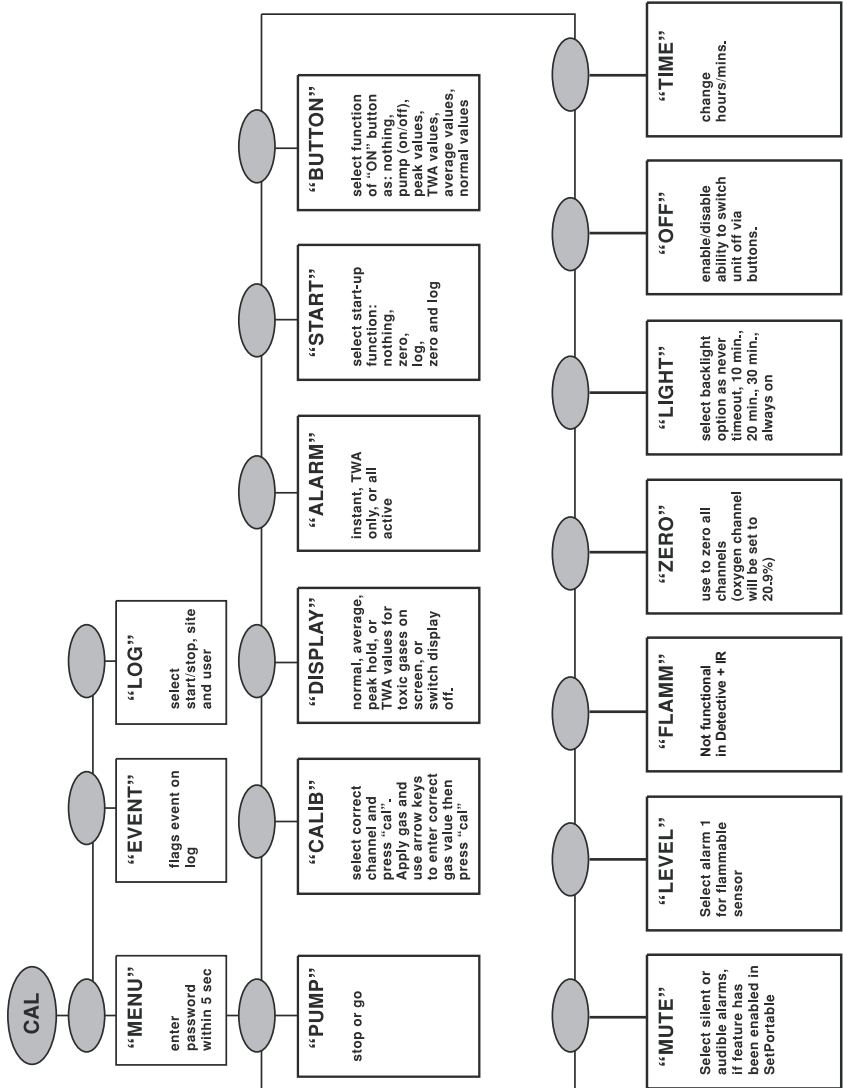



UK Office

Crowcon Detection Instruments Ltd
2 Blacklands Way,
Abingdon Business Park
Abingdon
Oxfordshire OX14 1DY
United Kingdom
Tel: +44 (0)1235 557700
Fax: +44 (0)1235 557749
Email: crowcon@crowcon.com
Web site: www.crowcon.com

Rotterdam Office

Crowcon Detection Instruments Ltd
Vlambloem 129
3068JG, Rotterdam
Netherlands
Tel: +31 10 421 1232
Fax: +31 10 421 0542
Email: eu@crowcon.com
Web site: www.crowcon.com

USA Office

Crowcon Detection Instruments Ltd
21 Kenton Lands Road,
Erlanger,
Kentucky 41018-1845
USA
Tel: +1 800 527 6926 or
1-800-5-CROWCON
+1 859 957 1039
Fax: +1 859 957 1044
Email: salesusa@crowcon.com
Web site: www.crowcon.com

Singapore Office

Crowcon Detection Instruments Ltd
Block 192 Pandan Loop
#5-01 Pantech Industrial Complex
Singapore 128381
Tel: +65 6745 2936
Fax: +65 6745 0467
Email: sales@crowcon.com.sg
Web site: www.crowcon.com