



# INSTRUCTION & OPERATIONS MANUAL

## **E8500** PORTABLE INDUSTRIAL INTEGRATED EMISSIONS SYSTEM COMBUSTION GAS ANALYZER

**E Instruments International LLC**  
402 Middletown Blvd, Suite 216  
Langhorne, PA, USA 19047  
Phone (215) 750-1212  
Fax (215) 750-1399  
[www.E-Inst.com](http://www.E-Inst.com)



## TABLE OF CONTENTS

LIST OF ABBREVIATIONS.....	3
ANALYZER OPTIONS .....	4
CHAPTER 1	
FUNDAMENTALS .....	5
CHAPTER 2	
THE INSTRUMENT KEYBOARD.....	11
CHAPTER 3	
BASIC INSTRUMENT OPERATION.....	13
CHAPTER 4	
POWER REQUIREMENTS.....	15
CHAPTER 5 - TECHNICAL	
SAMPLE FLOW & SAMPLE CONDITIONING SYSTEM .....	16
CHAPTER 6 - TECHNICAL	
SENSORS.....	20
CHAPTER 7	
ANALYZER SETUP .....	24
CHAPTER 8	
INTERNAL DATA STORAGE .....	28
CHAPTER 9	
WIRELESS REMOTE PRINTER.....	30
CHAPTER 10	
CALIBRATION .....	32
CHAPTER 11	
COMMUNICATIONS.....	37
CHAPTER 12	
MAINTENANCE .....	38
APPENDIX A	
MODEL E8500 – SPECIFICATIONS .....	41
APPENDIX B	
FIRMWARE PROGRAMMING.....	44
APPENDIX C	
REPLACEMENT PARTS .....	45

## LIST OF ABBREVIATIONS

### PARAMETERS

<b>AIR</b>	Excess air
<b>CO</b>	Carbon monoxide (a toxic gas)
<b>CO<sub>2</sub></b>	Carbon dioxide – NDIR measurement OR calculated from O <sub>2</sub>
<b>DUTY</b>	Duty cycle is a power setting given in percent
<b>EFF</b>	Combustion efficiency (for boilers and furnaces, does not apply to engines)
<b>HC</b>	Hydrocarbons (NDIR) measurement – (HC is same as CxHy)
<b>H<sub>2</sub>S</b>	Hydrogen Sulfide (a toxic gas)
<b>N.A.</b>	Parameter not available
<b>NO</b>	Nitric oxide (a toxic gas)
<b>NO<sub>2</sub></b>	Nitrogen dioxide (a toxic gas)
<b>NO<sub>x</sub></b>	Oxides of nitrogen (a toxic mixture of nitric oxide and nitrogen dioxide gases)
<b>O<sub>2</sub> REF</b>	Oxygen reference basis for correction of toxic gas concentrations
<b>SO<sub>2</sub></b>	Sulfur dioxide (a toxic gas)
<b>Ta</b>	Ambient (room) temperature
<b>Tp</b>	Preheated Air temperature
<b>Tg</b>	Gas temperature
<b>THERMAL EFF</b>	Engine thermal efficiency (heat loss method of calculation, not the same as combustion efficiency)

### UNITS

<b>CFM</b>	Cubic feet per minute, (volumetric stack gas flow-rate)
<b>CMM</b>	Cubic meters per minute, (volumetric stack gas flow-rate)
<b>FPS</b>	Feet per second (stack gas velocity measurement)
<b>MPS</b>	Meters per second (stack gas velocity measurement)
<b>#/H</b>	Pounds (of pollutant) per hour (mass emissions)
<b>T/D</b>	Tons per day (mass emissions)
<b>PPM</b>	Parts (of pollutant) per million (volume basis-dry)
<b>MGM</b>	Milligrams (of pollutant) per cubic meter
<b>GBH</b>	Grams (of pollutant) per (engine) brake horsepower-hour.
<b>#/B</b>	Pounds (of pollutant) per million BTU (of fuel).
<b>"WC</b>	Inches of water (draft/pressure measurement)
<b>mmWC</b>	Millimeters of water (draft/pressure measurement)
<b>kPa</b>	KiloPascals (draft/pressure measurement)
<b>mbar</b>	Millibars (draft/pressure measurement)
<b>%</b>	Percent by volume, dry-basis
<b>in<sup>2</sup></b>	Square inches (cross sectional area of stack)

## ANALYZER OPTIONS

The E INSTRUMENTS Model 8500 is an extremely versatile emissions measurement system that meets practically all emissions requirements. It has been designed as a modular system, permitting the installation, in the field, of most of the various available options. This manual describes the complete instrument equipped with all the options.

E8500 standard capabilities include 12"/300mm stainless steel probe (1470°F/800°C max.) with dual hose latex sampling line, ambient and stack temperature measurements, O<sub>2</sub>, CO, & NO gas sensors, dilution pump and electronic valve for dual range CO and purging capability, draft & differential pressure measurements, 1000 internal storage tags, wireless remote printer, Bluetooth wireless PC communications, EGAS Windows™ software, custom fuel programming option, and extensive help screens. The available options are separated into two categories:

### 1. ANALYZER SENSORS

- Nitrogen dioxide (NO<sub>2</sub>) sensor - 5-Series electrochemical sensor
- Sulfur dioxide (SO<sub>2</sub>) sensor – 5-Series electrochemical sensor
- Hydrogen sulfide (H<sub>2</sub>S) sensor – 4-Series electrochemical sensor
- Carbon dioxide (CO<sub>2</sub>) – non-dispersive infrared (NDIR) sensor
- Hydrocarbon (C<sub>x</sub>H<sub>y</sub> or HC) – non-dispersive infrared (NDIR) sensor
- High Carbon monoxide (CO) – non-dispersive infrared (NDIR) sensor

### 2. SAMPLE EXTRACTION & TRANSPORT SYSTEMS

- A. Stainless steel probe with dual hose latex sample line (1470°F/800°C max.) in probe lengths of 12"/300mm (standard) or 30"/750mm (optional)
- B. Inconel probe (2200°F/1200°C max.) with Viton sample line in various probe lengths

---

## CHAPTER 1

---

### FUNDAMENTALS

The E INSTRUMENTS Model 8500 Integrated Emissions System is a portable state of the art analyzer designed to measure, record and remotely transmit combustion parameters used for the following tasks:

- A. To measure the oxide of nitrogen emissions from stationary combustion sources by means of electrochemical sensors in accordance with the EPA Provisional Reference Method (EMTIC CTM-022, CTM-030, & CTM-034) for portable NO<sub>x</sub> analyzers.
- B. To measure the emissions of carbon monoxide, sulfur dioxide and oxygen sources from stationary and mobile combustion sources by means of electrochemical sensors.
- C. To use NDIR technology to measure simultaneously, gaseous hydrocarbons as methane, carbon monoxide, and carbon dioxide. **The Model 8500 Meets EPA's Reference Method 25B Appendix A 40CFR60 "Determination of Total Gaseous Organic Concentration Using a Nondispersive Infrared Analyzer"**.
- D. To compute the emission rates in lbs/million BTU or lbs/hour (mass emissions) for carbon monoxide, NO<sub>x</sub> and sulfur dioxide, and in tons/day for carbon dioxide according to the EPA's 40CFR75 regulations for continuous emissions monitoring.
- E. To measure the stack gas velocity and volumetric flow rate and emission rates according to the **EPA Method 2, or Method 2C, Appendix A of 40CFR60**.
- F. To assist the operator of a combustion source with the task of optimizing its efficiency, performance, and fuel savings.
- G. To be used as a management tool to assist the plant manager with keeping records and controlling costs.

The E INSTRUMENTS E8500 also uses the best available compact conditioning system technology with a proprietary battery operated thermoelectric chiller for accurate transport of the sample gas to the instrument. It also uses sophisticated electronics and programming design for increased accuracy and flexibility. It measures 3 temperatures and 8 different stack gases. It calculates efficiency of combustion as well as excess air and carbon dioxide. In addition, it can compute emissions in five different systems of units (PPM, milligrams/m<sup>3</sup>, lbs/MMBTU, grams/brake horsepower-hour, and lbs/hour). It stores, prints and graphs data. It communicates with a variety of other computers and

PDA's located nearby using Bluetooth wireless technology. It has a library of 15 fuels. It is designed to operate on its internal rechargeable battery pack as well as AC power.

The basic operation is as follows:

You insert the extraction probe in the stack of an operating combustion source such as a boiler, furnace, or combustion engine. A pump located inside the instrument draws a small sample of the stack gas. The sample is conditioned in a separate drawer compartment located inside the unit. The gas sensors analyze the contents of the stack gas and its temperature and calculate & display the results. In addition, an optional Pitot tube measures the velocity of the stack gases, which allows for mass emissions calculations. The results can also be stored in memory, printed out, or sent remotely to a computer using the Bluetooth wireless communications. The source operator can make the required adjustments on the combustion source based on the analysis of the stack conditions to optimize performance of the combustion source.

## A. UNPACKING THE INSTRUMENT

Every E INSTRUMENTS Model E8500 includes as standard equipment:

- Emissions Analyzer Model E8500 with integrated chiller conditioning system and automatic condensate drain
- Stack sampling probe that includes the probe shaft, sample line/hose, and thermocouple cable/connector
- Battery charger / AC adaptor for the analyzer
- EGAS™ Software for Windows™ CD-ROM
- Bluetooth module to connect to a computer via USB port
- Protective carrying case with shoulder strap
- Calibration certificate
- Instruction manual

## B. E8500 STARTING INSTRUCTIONS

1. Make sure the instrument is in a clean-air, room-temperature environment and turn it on by pressing the **POWER** button on the keypad.
2. Press the **OK** button to begin an autozero countdown. Once the display shows **AUTOZERO COMPLETE**, you are ready to use the instrument for your measurements. You can also initiate the autozero the analyzer by first pressing the **CALIB** button. The cursor will rest on the first line of the display, which states **Zero All Sensors**. Press **OK**. The display will automatically switch to the **MEASURE** mode and the last line will execute a countdown. At the end of the countdown you are ready to use the instrument.

3. If, at the end of the autozero countdown, the display shows an error message for a particular sensor, see the troubleshooting table in section D of this chapter. The instrument will measure correctly all sensors that do not show an error message.
4. With the analyzer in its case, connect the probe to the unit. One hose with the quick disconnect fitting connects to the “Sample In” port, and the other hose connects to the “+” pressure port. The thermocouple connector plugs into the “Stack” temperature connector. For the most accurate draft measurements, another autozero calibration should be done (through the CALIBRATION button menu) after the probe & hoses are fully connected to the analyzer but before the probe is inserted into the stack.
5. The instrument can have up to six electrochemical gas sensors and three infrared gas sensors. The E8500 has three temperature sensors total.
6. All sensor readings are single range readings with ranges listed in Appendix A. The CO reading is an exception. If the CO concentration exceeds the “Dilute CO” threshold that can be adjusted in the SETUP menu, a CO dilution takes place automatically to increase the CO dilution measurement range to as high as 20,000 ppm. If the measured CO concentration exceeds the upper end of the set dilution range, then a CO purge mode is initiated. If any of the ranges are exceeded for the other sensors the corresponding parameter will read OVER on the display. In that case, it is strongly recommended to withdraw the probe from the stack immediately and let the analyzer run with the pump on in a clean air environment to prevent sensor saturation.

**NOTE:** For CO measurements greater than 20,000 ppm, the optional CO NDIR sensor can measure up to 15% CO.

## C. SAFETY GUIDELINES & ADVICE

Most stack gases are hot, full of moisture, corrosive, and laden with soot particles.

To make sure that your instrument will give you a long time of trouble-free performance, please observe the following recommendations.

1. Follow the instructions in the E8500 manual.
2. Never use the instrument without the disposable fiber soot line filter or the condensation disk filter, which are located inside the analyzer’s drawer compartment. Operating the instrument without the filters will put the analyzer at high risk to damage the pump and sensors. These filters should be replaced as needed.
3. The built-in thermoelectric chiller removes moisture from the stack gas as it enters the analyzer, and the automatic condensate drain pump sends

- accumulate condensate out the bottom of the analyzer. It is best to let the E8500 run with the main gas pump on for at least a few minutes after measuring is done to let all of the condensate automatically drain out of the analyzer and to also fully purge the stack gases out of the unit.
4. Do not expose the probe tip to open flame.
  5. Do not rest the stack probe's sampling line on a hot boiler surface.
  6. Allow the probe tip to cool off and the instrument to aspirate clean air before packing the probe.
  7. It is strongly recommended to use single span calibration gas mixtures, preferably with balance nitrogen when calibrating the sensors for the most precise calibrations.
  8. Keep the analyzer upright in the protective carrying case with the LCD display facing up for best operations of the unit.
- WARNING: Never lay the E8500 on its side with the drawer upside down.**
9. If the analyzer enclosure is ever unscrewed and taken apart, be careful when pulling the top piece off the bottom piece because there is a ground wire connecting the two main pieces. Do not over-tighten the screws that hold the two main enclosure pieces together.



### D. AUTOZERO ERRORS & BASIC TROUBLESHOOTING

<b>AUTOZERO ERRORS</b>		
<b>Channel</b>	<b>Possible Causes</b>	<b>Resolution</b>
(Electrochemical sensors) CO NO NO <sub>2</sub> SO <sub>2</sub> H <sub>2</sub> S O <sub>2</sub>	Sensor has been recently exposed to gas and has not yet returned to zero.	Purge for 10 minutes, monitor sensor voltage, and re-zero.
	Battery was dead, sensor has destabilized.	Charge battery, wait up to 24 hours for sensors to stabilize, and re-zero.
	Sensor cell is dead.	Call for a replacement.
T Stack	Thermocouple is not connected	Check electrical connections running to the probe
	Thermocouple was hot	Probe tip should be cool
Stack Draft	Probe not connected	Draft voltage will be high. Connect probe and re-zero or ignore draft readings.
	Filters are dirty	Draft voltage will be low. Check filters
Infrared CO-CO <sub>2</sub> -HC 00	No response from infrared system	Autozero period must be at least 60 seconds. Zero the instrument again.
Infrared CO-CO <sub>2</sub> -HC XX	Infrared system is reporting error code XX	Infrared system may need maintenance.
Velocity	Velocity probe is not connected	Check probe and connections.
Flow (low)	Filters are clogged and/or wet	Replace filters as needed
Flow (high)	Gas exhaust at bottom of unit blocked	Unblock exhaust and check all hoses

<b>TROUBLESHOOTING</b>		
<b>Symptoms</b>	<b>Possible Causes</b>	<b>Resolution</b>
Analyzer will not turn on. (Screen is off)	Battery is dead.	Plug in the charger. Analyzer should turn on.
	Battery is not charging.	Check the charger and jack. Check the case for excessive heat.
	Internal initialization problem.	Reset the analyzer.
Analyzer turns on but screen is blue or faded.	Internal initialization problem.	Reset the analyzer.
	Analyzer is overheating.	Unplug charger. Check fan. Turn on & off to reinitialize.
Analyzer locks up or will not turn off properly.	Internal initialization or power problem.	Push the red power reset button.
“Low Flow” on display screen	Filters are clogged and/or wet	Check & replace filters inside drawer as needed
	Probe/Hoses are blocked or pinched	Check probe & hoses
“High Flow” on display screen	Gas exhaust at bottom of analyzer is blocked	Check exhaust hose to make sure it is not blocked or clogged

---

## CHAPTER 2

---

### THE INSTRUMENT KEYBOARD



A brief explanation of the instrument's buttons is as follows:

<b>CALIB</b>	Controls calibration settings and zeroing of the analyzer's sensors.
<b>SETUP</b>	Controls all customization parameters (such as measurement units) for the analyzer
<b>MEASURE</b>	Displays the analyzer's currently measured data in either of two fonts: A. Small fonts (all data displayed simultaneously plus range indicated, battery condition and time) B. Large fonts (four data parameters displayed simultaneously)
<b>POWER</b>	Turns analyzer and conditioning system on and off
<b>STORE</b>	Controls operation of the analyzer's internal data storage
<b>PRINT</b>	Executes print commands for the analyzer's remote printer
<b>OK</b>	Used with the direction keys to change a setting or navigate the menus
▲	Moves the cursor up or increments the entry marked by the cursor
▼	Moves the cursor down or decrements the entry marked by the cursor
◀	Moves the cursor to the left
▶	Moves the cursor to the right

#### NOTE:

The orientation of the display (the display's lettering) rotates automatically by 90 degrees depending on the analyzer's position so that the words & numbers on the display can be read properly. The analyzer's position also changes the orientation of the arrows so that they always conform to the direction pointed.

---

## CHAPTER 3

---

### BASIC INSTRUMENT OPERATION

It is possible to master the basic operation of the instrument in a few minutes by following the procedure outlined below. Please refer to the other sections of this manual for a description of the more advanced features.

The E8500 emissions analyzer consists of the following three major components:

1. The probe sampling line, whose function is to extract the sample, sense the stack temperature and depending on the option measure the stack gas velocity
2. The conditioning system is located inside the analyzer's drawer compartment and consists of the thermoelectric chiller, automatic condensate draining system, and filters
3. The main section of the analyzer that houses all the gas sensors, battery pack, and PC board

To operate the instrument, follow the steps outlined below.

1. Turn the analyzer on. The instrument pump will immediately turn on and the E INSTRUMENTS logo will appear. Press **OK** to run the autozero cycle.
2. Attach the probe and sampling line that is supplied with your analyzer.
3. If you are using the analyzer for the first time, press the **SETUP** key to set the appropriate parameters (i.e. fuel, units, etc.) for your application. See Chapter 7 for an explanation of each parameter. A table of the SETUP display is shown here.

APR 1 '11 12:45:00
Fuel: NATURL GAS
Temperature Units: F
Measure Units: PPM
Pressure Units: inWC
O2 Reference: TRUE
Pumps: OFF
Dilution Duty: 100%
Water Drain: 5min
Chiller Duty: 50%
Dilute CO: 4000 PPM
Use CO-IR: 9000 PPM
Thermal Eff: 0.30
Display Contrast: 24
Baudrate: 9.6 kbps
Version: 1.0
Battery: x.xx V

- Press the **MEASURE** key and check the unit's battery condition.

EFF:xx.x%	CO: XXXXPPM
Tg: xxxxx°F	NOx:XXXXPPM
O2: xx.x%	NO: XXXXPPM
HC:xx.xx%	NO2: XXXPPM
CO2:xx.x%	SO2: XXXPPM
DFT:xx.x"	H2S: XXXPPM
LOW RANGE  12:45:00	

The **MEASURE** key toggles between a small font and a large font screen. Select the small font screen.

The battery icon is displayed in the middle of the bottom line of the display. Its condition is marked by the shaded fraction of the icon. If the unit is powered by the battery charger a small "plug" icon will replace the battery icon.

**NOTE:** Depending on the options enabled for your analyzer some of the entries in one or more of the displays shown above will be blank if that option is not available.

**NOTE:** When connecting the battery charger to the analyzer make sure that the "plug" icon appears on the **MEASURE** screen. This ensures a proper power connection and charging of the batteries.

- After making sure that the analyzer is drawing clean air at room temperature, press the **CALIB** key. The cursor (reverse color) will point to the line:

Zero All Sensors

Press the **OK** key to execute an autozero cycle of all the sensors.

- At the end of the autozero period, all sensors should indicate zero reading with the exception of the oxygen sensor, which should read 20.9% (the concentration of ambient dry air), and the stack temperature, which should correspond approximately to the room temperature.
- Insert the analyzer's probe into the stack or engine exhaust. Use the **MEASURE** key to read the stack parameters.
- To obtain a printout of the data displayed, press the **PRINT** key. The cursor (reverse color) will point to:

Print Test Record

Press the **OK** key to execute a printout on the E8500's remote printer.

- Measured data can be stored in the analyzer's internal memory. Please refer to Chapter 8 for more details about data storage.
- When you are finished with your measurements, withdraw the probe from the stack, allow the analyzer to draw clean ambient air for several minutes and for the probe to cool down, before packing the analyzer in its carrying case.

---

## CHAPTER 4

---

### POWER REQUIREMENTS

The E8500 can run off of AC power or the internal rechargeable battery pack. It is recommended to run the E8500 off AC power as often as possible for maximum operating time and optimal chiller performance.

Power is supplied by a Ni-MH rechargeable battery pack. A 110 – 240 Volt AC charger having a 12 Volt DC / 2.5A output is supplied with the instrument. The battery charger will fully charge the battery pack in a minimum of six hours.

The battery pack will supply power to the analyzer for about 4 to 8 hours of continuous operation depending on the unit's options and utilization.

A new E8500 should be charged with the unit powered off for 12 to 24 hours. It is not suggested to charge the unit for more than 24 hours when powered off.

You can check the condition of the batteries at any time:

1. By pressing the **MEASURE** key, (small font screen) and observing the battery icon, located at the bottom of the display, in the middle, or
2. By pressing the **SETUP** key and observing the actual battery voltage, displayed on the last line. When the unit is operating on its batteries, the voltage displayed will vary from an initial 8.0 to 8.4 volts (fully charged) dropping slowly to approximately 7 volts (batteries nearly empty). When the battery voltage drops to 7.1 volts a "low battery" warning will appear on the display. Within a few minutes later the instrument will automatically turn off, to preserve the remaining battery power for the sensor bias voltages.

## CHAPTER 5 - TECHNICAL

### SAMPLE FLOW & SAMPLE CONDITIONING SYSTEM

#### PART A. THE EXTRACTION PROBE AND SAMPLING LINE

A number of different types of probes are available depending on the application requirements. The probe consists of the extraction probe, the sampling line and the stack thermocouple.

1. Medium temperature probe and latex sampling line. This standard probe is suitable for temperatures up to 800°C/1470°F.
2. High temperature probe and viton sampling line. This probe uses an inconel extraction probe suitable for temperatures up to 1200°C/2200°F and very low NO<sub>2</sub> and SO<sub>2</sub> loss sampling line suitable for emissions measurements. Different extraction probe and sampling line lengths are available on request.

The end of the probe's sampling line connects to the SAMPLE IN quick disconnect connector of the analyzer and the thermocouple connector connects to TEMPERATURE STACK input of the analyzer.

**Pitot tube** – This optional part consists of stainless steel tubing with the tips open and bent at a certain angle according to the EPA specifications of 40CFR60 Appendix A, Method 2 for measuring stack gas velocities. The Pitot tube must always be oriented with the open tips parallel to the direction of the stack gas flow. Care must be taken to keep the tubes from getting clogged by soot particles. The end of the Pitot tube assembly is connected by means of two flexible hoses to a very accurate pressure transducer located inside the drawer.

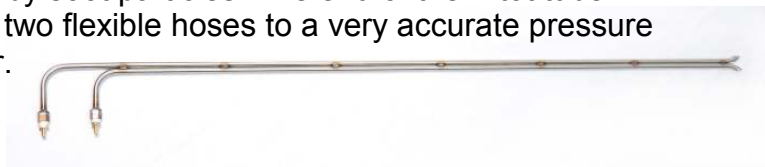

#### PART B. THE SAMPLE CONDITIONING SYSTEM

The purpose of the sample conditioning system is to remove the excess condensation from the extracted stack gas sample and also to remove soot particles. The exhaust sample contains typically between 5% and 20% of water vapor, most of which will condense in the probe and sample line.



NO<sub>2</sub> and SO<sub>2</sub> are gases that are highly soluble in water. To prevent significant loss of NO<sub>2</sub> and SO<sub>2</sub> during transport of the sample from the probe to the analyzer, the following conditions must be satisfied:

1. Rapid sample transport. This is accomplished by maintaining a high flow rate using a relatively small diameter sampling line.
2. Preferably use of a sample line made from a highly hydrophobic material, such as Teflon, Viton or stainless steel.
3. Minimum contact of the gas sample with the water collection mechanism and also no additional condensation to occur following the thermoelectric chiller. This is accomplished by using a specially designed Peltier cooled manifold to separate the gas from the water.

The entire conditioning system is located inside the drawer compartment of the analyzer.

You can open the drawer compartment to access the conditioning system by pulling on the black knob that is located on the right side of the instrument front above the temperature connectors.

The following figure shows the drawer compartment containing the sample conditioning apparatus:

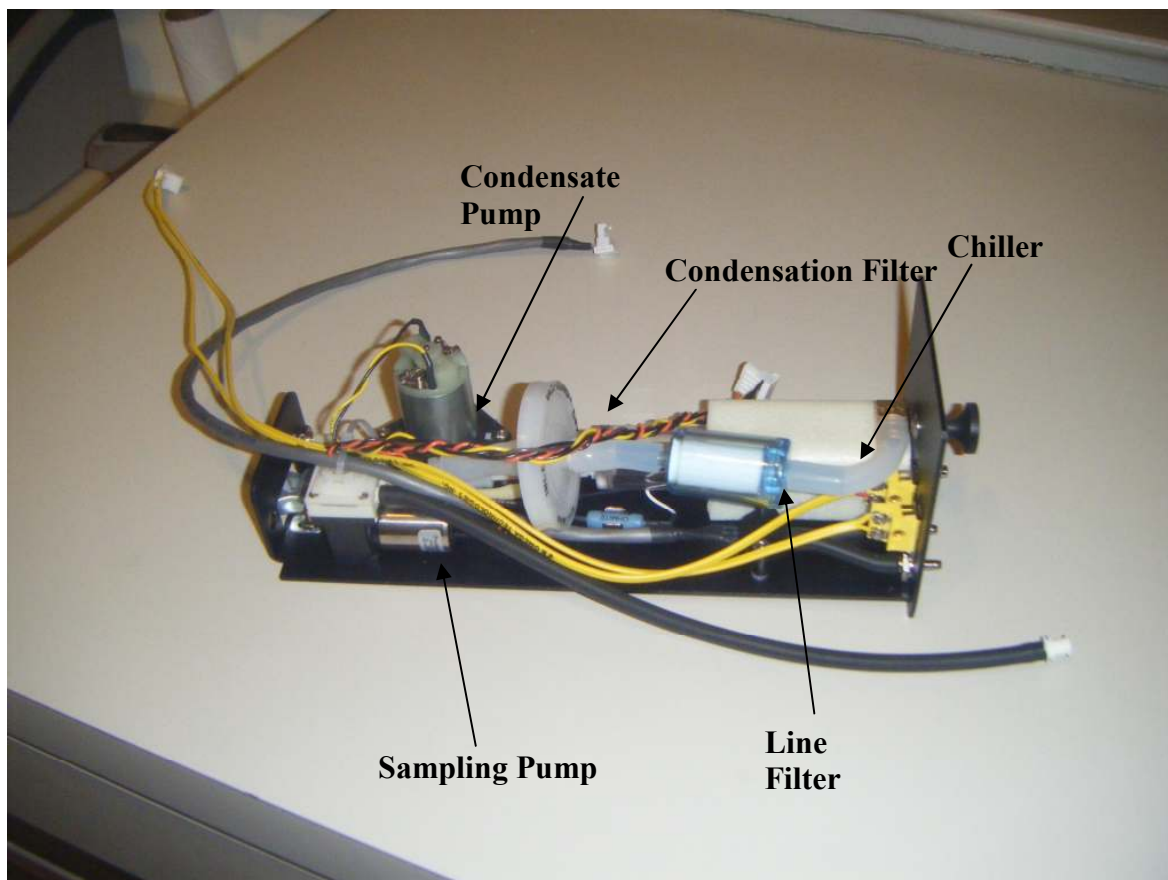

The following components are mounted on the conditioning system:

1. Thermoelectric chiller. The sample gas enters this aluminum manifold from the front panel. The condensed water is removed and collects at the bottom. The dry sample exits towards the filters. The manifold is cooled by the Peltier element, powered by electrical pulses of user-settable duty cycle. By cooling the chiller below ambient temperature, any further condensation in the analyzer is prevented.  
The chiller will maintain the sample at a certain temperature below ambient temperature to ensure that no further condensation takes place inside the analyzer. You can control this temperature differential by adjusting the CHILLER DUTY CYCLE, if necessary, as detailed below.

The duty cycle of the thermoelectric chiller is set at the factory to 75%. It should not be adjusted unless when being used to measure a stack gas with very high water content. It can be adjusted as follows:

- 1) Press the **SETUP** key. The **SETUP MENU** will be displayed.
- 2) Press the **UP/DOWN** keys until the cursor points to **COOLER DUTY**.
- 3) Press the **OK** key.
- 4) Use the **UP/DOWN** keys to set the power duty cycle.
- 5) Press the **OK** key.

2. Water trap. The condensed water collects inside this water trap.
3. Condensate pump. This peristaltic pump operates automatically on a periodic basis that can be set by the customer to remove the condensed water from the water trap and discharge it in the back of the instrument. The default operation is 10 seconds on, 5 minutes off.
4. Line filter. The dried gas sample goes through a disposable fiber filter whose function is to trap any soot particles from the sample. This filter must be inspected often especially for oil or coal fired applications.
5. Condensation filter. The primary function of this 2 ¼" diameter filter is to prevent any residual condensation from reaching the sensors area. This precaution is particularly important, especially if the analyzer is equipped with an NDIR sensor bench.
6. Sample pump. This is a high quality diaphragm pump whose function is to extract a sample from the stack. Its flow rate is adjustable and can be set by instrument command. Typical flow rates are 1 – 1.5 liters per minute.
7. Damper. The last component is the conditioning system is a small damper whose function is to smooth the flow pulsations generated by the sample pump. The electrochemical sensors are diffusion type and their accuracy is affected by significant flow pulsations.

## CHAPTER 6 - TECHNICAL

### SENSORS

The great versatility of the Model 8500 Emissions system is partly due to the large number of sensors available within a single analyzer.

These sensors are primarily gas sensors and can be grouped into three categories based on their principle of operation:

1. Seven electrochemical gas sensors.
2. Three NDIR (infrared gas sensors)
3. Non-gas sensors (temperature & draft/stack gas velocity) sensors

The figure below shows the location of the sensors on their housing:

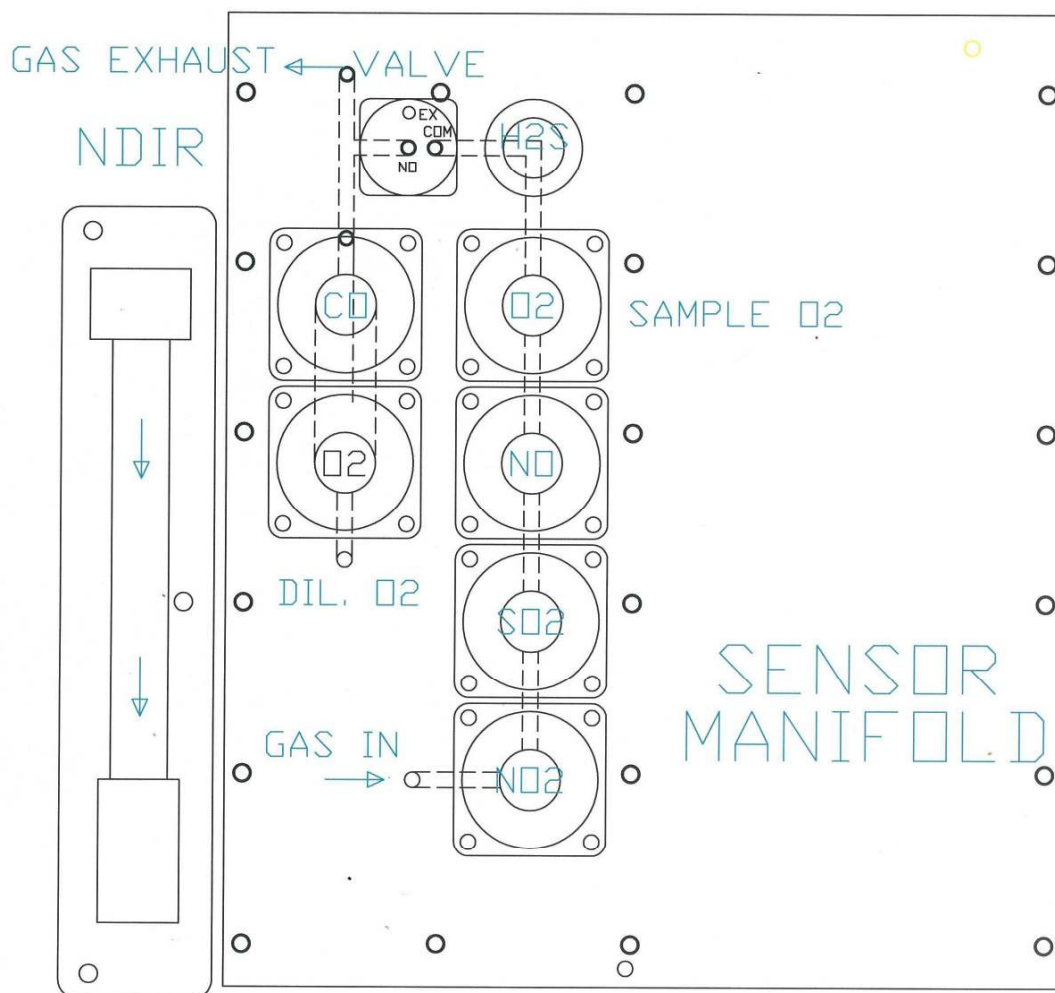

## 1. ELECTROCHEMICAL SENSORS

All electrochemical sensors, except for the H<sub>2</sub>S sensor are of the 5 series type mounted on bayonet style fittings for easy removal.

The electrochemical sensors are described below following the order by which the gas flows through the manifold.

### A. Nitrogen dioxide sensor (NO<sub>2</sub>)

This is a three electrode sensor that responds to nitrogen dioxide gas. Nitrogen dioxide is a “sticky” gas and this sensor’s response is usually the slowest of all sensors.

B. Sulfur dioxide sensor (SO<sub>2</sub>). It is a three electrode sensor that responds to sulfur dioxide gas. It is equipped with an inboard filter to remove interference from H<sub>2</sub>S gas.

### C. Nitric oxide sensor (NO sensor)

This is also a three electrode sensor that responds to nitric oxide. It is equipped with an inboard filter to remove any interference from NO or SO<sub>2</sub> gases.

The nitric oxide sensor requires a constant bias-voltage for proper operation. This is supplied by the analyzer’s battery. If the battery voltage drops below a certain value the analyzer will turn off automatically to maintain the sensor bias. If, however, the battery voltage further drops to near zero, one must wait 24 hours after connecting the battery charger, for the sensor bias to recover.

### D. Oxygen sensor (O<sub>2</sub> sensor)

This sensor measures the oxygen concentration in the sample. It is a two-electrode electrochemical cell. It has a silver cathode and a lead anode. Oxygen diffuses through a tiny hole and reacts with the lead anode. The reaction produces an electric current. The unit software linearizes the current vs. oxygen response. The cell becomes exhausted when all the lead is consumed.

### E. Hydrogen sulfide sensor. (H<sub>2</sub>S)

This is a 4-series three-electrode micro sensor with low methanol interference. It measures the concentration of hydrogen sulfide, which is a highly toxic gas. Special precautions must be taken during calibration.

### F. Carbon monoxide sensor and sensor assembly (CO)

Unlike the other toxic sensors the carbon monoxide sensor is mounted in an assembly that includes a three way electronic valve and an additional oxygen (dilution) sensor. The sensor itself has an inboard filter to remove interference from NO gas.

This sensor has four electrodes. One measures the concentration of carbon monoxide gas and the other the concentration of any interfering hydrogen gas (It is hydrogen compensated).

Furthermore, this sensor assembly is designed to provide the CO sensor with a dual range capability and also to purge the sensor with air, if the CO gas concentration exceeds the sensor's diluted upper limit.

If the CO concentration exceeds the sensor's low range selectable upper limit, a "dilution" pump turns on mixing dilution air with the sample. A second "dilution" oxygen sensor measures the resultant concentration of the combined sample and air streams and computes the correct CO concentration.

(For still higher CO concentrations please refer to the NDIR CO sensor option).

## 2. NDIR (INFRARED) SENSORS

The Model 8500 emissions analyzer can be equipped with infrared sensor measurement capability for the measurement of three gases: carbon monoxide (high range), carbon dioxide and hydrocarbons.

The NDIR bench is designed for operation primarily with measurements of engine exhausts, according to the California BAR 97 regulations.

The infrared option has the following specifications:

<b>GAS</b>	<b>RANGE</b>	<b>ACCURACY</b>
CARBON MONOXIDE (CO)	0% - 10% 10% - 15%	3% relative 5% relative
CARBON DIOXIDE (CO <sub>2</sub> )	0% - 16% 16% - 20%	3% relative 5% relative
HYDROCARBONS (HC or C <sub>x</sub> H <sub>y</sub> )	0 - 0.40 % 0.40 – 1.00 % 1.00 – 3.00 %	3% of Rdg. + 0.01% 5% of Rdg. 8% of Rdg.

## 3. NON-GAS SENSORS

### A. Ambient temperature sensor

This is an IC sensor located near the cold junction of the thermocouple. The ambient temperature is displayed on the CALIB screen and is used for temperature compensation. This sensor is located in the vicinity of the gas sensors and also monitors the temperature of the cells as required by the EPA's Method CTM-034.

B. Stack temperature sensor

The thermocouple is located at the tip of the probe. It measures the stack temperature minus the ambient temperature. The thermocouple junction is a shielded, ungrounded, inconel sheathed, type K thermocouple with a capability of measuring temperatures from 0 to 2000 °F. The instrument software linearizes the thermocouple output to improve the accuracy.

C. Draft sensor / Gas velocity sensor.

If the analyzer comes with the stack gas velocity option (separate S-type pitot tube and tubing), the pressure sensor, located inside the drawer compartment, is a very low range (0-10" WC) pressure sensor.

If the analyzer does not have the gas velocity option, then the pressure sensor is a 0-1 PSI, higher range sensor for the measurement of stack draft.

Pressure / velocity will zero every time an autozero countdown is carried out.

---

## CHAPTER 7

---

### ANALYZER SETUP

The SETUP MENU allows the operator to change system parameters.

APR 1 '10 12:45:00
Fuel: NATURAL GAS
Temperature Units: F
Measure Units: PPM
Pressure Units: inWC
O2 Reference: TRUE
Pumps: AUTO 1500cc/m
Dilution Duty: 90%
Water Drain: 5min
Chiller Duty: 70%
Dilute CO: 4000 PPM
Use CO-IR: 9000 PPM
Thermal Eff: 0.25
Display Contrast: 24
Baudrate: 9.6 kbps
Velocity Units: FPS
Stack Size: 144 in <sup>2</sup>
Version: 1.01
Battery: x.xx V

Every parameter listed on the SYSTEM MENU screen can be changed as follows:

- a. Use the **UP / DOWN** keys to move the highlighted line to the parameter you wish to change.
- b. Press **OK** to edit the value. The arrow will disappear as the current line shifts to the left by one character and a cursor appears over the value. This indicates that you are in edit mode.
- c. Use the **UP / DOWN** keys (buttons displaying the triangles) until the desired value of the selected parameter appears on the display.
- d. Press the **OK** key to execute the change.



A more detailed explanation of each parameter follows:

- 1) **DATE & TIME:** The analyzer's internal clock is displayed in the format month-day-year, hour-minute-second. Hours are always displayed using a 24-hour clock format.
  
- 2) **FUEL:** The analyzer has the following fifteen fuels stored in its memory
  - (1) #2 OIL
  - (2) #4 OIL
  - (3) #6 OIL
  - (4) NATURAL GAS
  - (5) ANTHRACITE (COAL)
  - (6) BITUMINOUS (COAL)
  - (7) LIGNITE (COAL)
  - (8) WOOD, 50% MOISTURE
  - (9) WOOD, 0% MOISTURE
  - (10) KEROSENE
  - (11) PROPANE
  - (12) BUTANE
  - (13) COKE OVEN GAS
  - (14) BLAST FURNACE
  - (15) SEWER GAS

To select the desired fuel, press the **UP / DOWN** keys until the desired fuel appears on the top of the display and then press **OK**. The fuel selection affects the following parameters: combustion efficiency, carbon dioxide calculation and display of toxic gases in units other than PPM.

- 3) **TEMPERATURE UNITS:** The **UP / DOWN** keys toggle between °F (Fahrenheit) and °C (Celsius). Stack temperature and ambient temperature will be displayed, printed, and saved in the selected units.
  
- 4) **MEASURE UNITS:** When the cursor is blinking on this line, you can select any of the following units of measurement for the toxic gases (CO, NO, NO<sub>2</sub>, SO<sub>2</sub> & H<sub>2</sub>S):
  - PPM : Parts per million (volumetric)
  - MGM : Milligrams per cubic meter
  - #/B : Pounds (of pollutant) per million BTU of fuel
  - GBH: Grams (of pollutant) per brake horsepower-hour

To choose the desired emission units, toggle the **UP / DOWN** buttons until the proper units are displayed. Then press the **OK** key. If you select GBH (grams/brake horsepower-hour) as the desired units, you must not forget to set the value of the (engine) thermal efficiency also! You can obtain this figure from the engine's manufacturer specifications. It differs somewhat as a function of engine type and load factor. (Typically, it is a number between 0.25 and 0.35) The analyzer's default value is 0.25. If the thermal efficiency is not known, it may be computed by using the engine's BSFC (brake-specific fuel consumption-BTU/BHP-HR) as follows:

ENGINE EFFICIENCY = 2547/BSFC

*NOTE: Emission measurements in PPM, MGM, #/B and GBH are carried out on a dry basis as required by the EPA's 40CFR75. (The E8500 is an extractive analyzer, whose conditioning system removes most of the water vapor before the sample reaches the sensors).*

*NOTE: Values of emissions in #/B and GBH are fuel and CO<sub>2</sub> dependent. The fuel parameters for certain typical fuels used in the analyzer (i.e. the F- factors for anthracite, etc.) have been modified to be identical to those specified in 40CFR60 Appendix A method 19 of the code of federal regulations. Consult E INSTRUMENTS, Inc., for details and correction factors.*

**NOTE: NO and NOX emissions in #/B or GBH are computed as NO<sub>2</sub>**

- 5) PRESSURE UNITS: The Stack Draft measurement can be shown in inches of water (inWC), millibar (mbar), millimeters of water (mmWC), or kilopascal (kPa).

1 mbar = 0.10 kPa = 0.40 inWC = 10.2 mmWC

- 6) C<sub>x</sub>H<sub>y</sub> UNITS: The hydrocarbon measurement can be displayed in either % or ppm units. The factory setting is for % units, and % units are recommended for most hydrocarbon measurements. The ppm units are only recommended for very low hydrocarbon measurements.

If using ppm units, an extra autozero calibration should be done within the first few minutes after the initial autozero calibration has been completed. Additionally, extra autozero calibrations should be done every 30 to 45 minutes. These extra autozero calibrations will allow for greater accuracy of the C<sub>x</sub>H<sub>y</sub> measurements especially when measuring in ppm units.

- 7) O<sub>2</sub> REFERENCE: Many environmental regulations require that the concentrations of pollutants measured, be corrected to some reference value of oxygen other than the actual concentration at the time of the measurement. Typical oxygen reference values are 0% (air free), 3%, 7% or 15%. To select the desired oxygen reference value, press the **OK** key repeatedly until the blinking cursor is located on the OXY REFERENCE line on the display, as described above. Toggle the **UP / DOWN** buttons, until the desired value of the reference oxygen is displayed. (Range is 0-20% in 1% increments). Then press the **OK** key. When the O<sub>2</sub> reference is set at anything other than "TRUE", the O<sub>2</sub> measurement on the display screen will have reverse contrast (white letters/numbers on dark background). To return to uncorrected measurements, press the **UP** button until the display reads:

O<sub>2</sub> REF: TRUE

*NOTE: Setting the OXYGEN REFERENCE to a value other than TRUE affects values of emissions concentrations in PPM and MGM. It does not affect values in #/B or GBH.*

- 8) PUMP: Pump status is displayed:
- AUTO - Automatic sample and dilution control mode is selected, and typical flow-rate is shown.
  - SAMPLE - Pump remains in sample mode (dilution disabled), and the current duty cycle of the pump is shown. The duty cycle\*\*\* can be set with the **UP / DOWN & OK** keys.
  - DILUTE - Pump remains in dilution mode, and the current duty cycle\*\*\* of the pump is shown.
  - PURGE – Purge mode is enabled, and the sample pump is turned off.
  - OFF – All pumps are turned off.

\*\*\*The manufacturer strongly suggests not changing the duty cycle values without consulting the manufacturer first.

- 9) DILUTION DUTY: This controls the power to the dilution pump. The manufacturer strongly suggests not changing this duty value without consulting the manufacturer first.
- 10) WATER DRAIN: This controls how often the analyzer's peristaltic pump should drain water from the small water trap of the conditioning system
- 11) CHILLER DUTY: This setting adjusts the temperature of the thermoelectric chiller. See CHAPTER 5.
- 12) DILUTE CO: This sets the CO concentration above which the dilution system will be engaged. The default value is 5000 PPM.
- 13) PURGE CO / USE CO-IR: This sets the maximum CO concentration for the electrochemical sensor. Higher concentrations will engage a purge cycle for the CO sensor to prevent it from becoming saturated. Factory default is set at 17,000 PPM. If you have an NDIR infrared system, the infrared CO data will be used above this point. With the infrared system, CO is always displayed as a percentage (%).
- 14) THERMAL EFF: Selects the thermal efficiency of the engine. See MEASURE UNITS above.
- 15) DISPLAY CONTRAST: Select the best value for viewing the LCD screen.
- 16) BAUDRATE: The speed of the Bluetooth port is set here.
- 17) VELOCITY UNITS: (Velocity Option) Select between feet per second (FPS), meters per second (MPS), cubic feet per minute (CFM), or cubic meter per minute (CMM).
- 18) STACK SIZE: (Velocity Option). Estimate the cross-section area of your stack in square inches (in<sup>2</sup>) and set this value to obtain accurate stack gas flow measurements in CFM or CMM.

---

## CHAPTER 8

---

### INTERNAL DATA STORAGE

The STORE MENU allows the operator to store data and manage the internal storage tags.

Store Current Buffer
Select Buffer
Start Average Test
Start Periodic Store
Select Interval: 1m
Review Buffer
Name Buffers
Erase Buffers
00: TAG#02

The E8500 has 1000 internal storage tags. Each tag stores one complete set of emissions data. There are two ways to store emissions data to the analyzer's buffer. You can either store data by selecting the option STORE CURRENT DATA after pressing the **STORE** key, or alternatively you can make use of the analyzer's capability of storing data automatically on a periodic basis. You can set the time period between data storage. The STORAGE MENU shows the relevant display lines for the storage options.

1. STORE CURRENT BUFFER: The analyzer will store one set of data into the tag currently selected. The index number and the name of this tag appears at the bottom of the screen.
2. SELECT BUFFER: Selecting this item will display an index of the analyzer's 1000 internal storage tags. Tags that are used have an icon next to their index number. The selected storage tag is indicated by the reverse color line. When data is stored, this pointer will automatically advance to the next available tag. If you want to store data in a different location, use the UP, DOWN, & OK keys to select a new tag. As you scroll up and down, tags containing data show their date and time at the bottom of the display. Empty tags show the word *empty*.
3. START AVERAGE TEST: This will begin a period of data averaging, with the average values stored periodically in successive memory tags. The interval between each storage cycle is displayed below and can be set by the user. Once enabled, this line will read: STOP AVERAGE TEST.

4. **START PERIODIC:** This will turn on the periodic store function. In this mode, the unit will continuously store data at an interval displayed on the next line. Once enabled, this line will read: `STOP PERIODIC`.
5. **SELECT INTERVAL:** The time between each store is set here. This can range from 10 seconds to 60 minutes.
6. **REVIEW BUFFER:** This choice allows you to view previously saved data. Press **OK**. The display will switch to the data screen, with the data in the first tag displayed. The time and date when the data was saved will appear at the bottom of the display. Use the **UP / DOWN** keys to scroll through the tags.

7. **NAME BUFFERS:** This choice will take you to another screen where you can rename one or more tags. This is useful if you use several tags together to form a test series. Select the starting test index with the **UP / DOWN / LEFT / RIGHT** keys and press **OK**. Next, select the ending test index. The cursor will move to the first character of the first tag's name, and the alphanumeric keyboard will appear. Use the **UP / DOWN / LEFT / RIGHT** keys to navigate around the keyboard, and press **OK** to select the letter or number. For lower-case letters, highlight `shift` and press **OK**, for symbols, highlight `sym` and press **OK**. The arrows in the corner will move the cursor forward or backward through the tag's name.

*** NAME BUFFERS ***									
Starting Tag: 00									
Ending Tag: 00									
Name:xxxxxxxxxxxxxxxx									
1	2	3	4	5	6	7	8	9	0 ◀
A	B	C	D	E	F	G	H	sym	▶
I	J	K	L	M	N	O	P	shift	
Q	R	S	T	U	V	W	X	Y	Z

8. **ERASE BUFFER:** This option is used to erase stored data. Data that has been stored in the analyzer's memory will be retained even after the instrument has been shut off and its batteries removed. To erase the contents of a specific tag, use the **UP / DOWN** keys to move the arrow to the desired tag. As you scroll up and down, tags containing data show their date and time at the bottom of the display. Empty tags show the word `empty`. If you wish to erase all 1000 of the analyzer's stored data, move the arrow to the entry `ALL TAGS` and press **OK**.

## CHAPTER 9

### WIRELESS REMOTE PRINTER

The E8500 uses a wireless remote printer. The printer is powered by a rechargeable battery. A charger is supplied with the printer. The printer is optional with the E8500.

First you must turn the printer on. Then press **PRINT** to scan and connect with your wireless printer to establish communications between the analyzer and the printer.

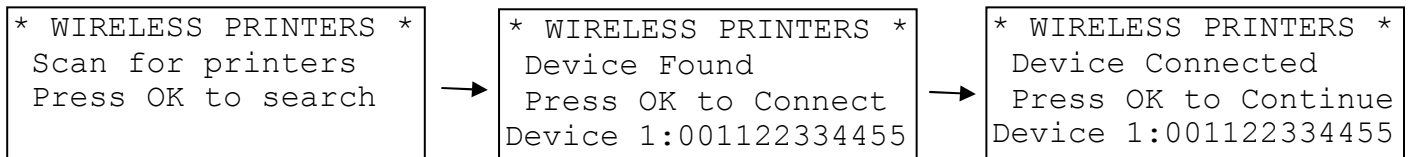

When you have connected successfully the printer's green status light will turn on. Pressing the **PRINT** key will now display the PRINT MENU.

The PRINT MENU allows the user to print test records.

```
Print Test Record
Start Test Log
  Log Interval:
Print Buffer
Edit Customer Name
Calibration Record
Paper Feed On/Off
Mobile Printer...
```

**PRINT TEST RECORD:** This option will print a test record of the current stack parameters.

**PRINT TEST LOG:** This option begins a log of the following combustion parameters: stack temperature, oxygen, carbon monoxide, excess air, and efficiency.

**LOG INTERVAL:** This selects the interval between each log entry. The interval can be set between 1 and 60 seconds.

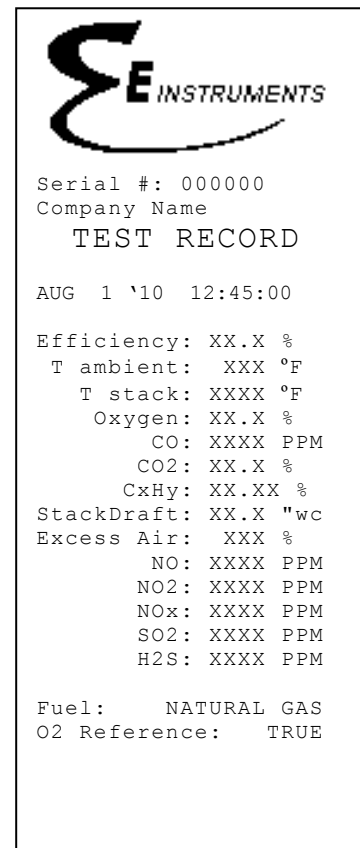

**PRINT BUFFER:** This option is used to print data stored in the analyzer’s memory. Each line corresponds to one storage tag. Tags containing data show an icon next to the index number. When you scroll up and down, the date (mm/dd) and time (hh/mm) when the data was stored appear at the bottom; empty tags show the word “empty”. To print the contents of a specific tag, use the **UP / DOWN** keys to move the arrow to the desired tag and press **OK**. If you wish to print all of the analyzer’s stored data in sequence, move the arrow to the entry `ALL TAGS` and press **OK**.

**CONFIGURE RECORD:** This option allows the user to add, delete, or change the order of the parameters that appear on the paper print out.

**EDIT CUSTOMER NAME:** This will display a screen where you can change the information printed at the top of each printout. Usually the customer’s name or the operator’s name appears here. To edit this information, use the **UP / DOWN / LEFT / RIGHT** keys to navigate around the keyboard, and press **OK** to select the letter or number. For lower-case letters, highlight `shift` and press **OK**, for symbols, highlight `sym` and press **OK**. The arrows in the corner will move the cursor forward or backward through the name.

** EDIT HEADER INFO *									
E INSTRUMENT ANALYZER									
1	2	3	4	5	6	7	8	9	0 ◀
A	B	C	D	E	F	G	H	sym	▶
I	J	K	L	M	N	O	P	shift	
Q	R	S	T	U	V	W	X	Y	Z

**CALIBRATION RECORD:** This option will print a record of each sensor’s last calibration, including the date of calibration and span gas value used.

**PAPER FEED:** This toggles the printer’s motor on and off, advancing the paper out the top of the analyzer as needed. The motor will not turn on if there is no paper present.

## CHAPTER 10

### CALIBRATION

Every instrument must occasionally be calibrated against some known value of a parameter in order to make sure that its accuracy has not deteriorated.

Instrument calibration requires two steps. The first step is to zero the analyzer in a clean, ambient temperature environment. The second step uses certified span gas cylinders of known concentration to carry out a span calibration of the gas sensors.

The CALIBRATION MENU lets you set span calibration values for each sensor and performs all sensor calibrations. The CALIBRATION MENU is shown below.

A brief explanation of the parameters shown follows below:

```
**** CALIBRATION ****
Zero All Sensors
Zero Thermocouples
AutoZero Errors
Sensor History
T ambient: 74 °F
T preheat: 74 °F
Zero Time: 60sec
Span Time: 120sec
** Span Lockout **
Span CO: xxxx PPM
Span H2: xxxx PPM
Span NO: xxxx PPM
Span NO2: xxxx PPM
Span SO2: xxxx PPM
Span H2S: xxxx PPM
Span CO-IR:xx.x %
Span CO2: xx.x %
Span HC: xx.xx %
Span Draft: xx "
```

**ZERO ALL SENSORS:** This will set the zero point of CO, CO<sub>2</sub>, HC, NO, NO<sub>2</sub>, SO<sub>2</sub>, H<sub>2</sub>S, and draft or velocity values.

**ZERO THERMOCOUPLES:** This zeros the stack and auxiliary thermocouples. The thermocouples must be at room temperature when zeroing.

**AUTOZERO ERRORS:** This will display a list of sensors that were out of the analyzer's acceptable range during the last autozero countdown.

**SENSOR HISTORY:** The date that each sensor was installed is displayed, along with the date the sensor was last calibrated and the span gas concentration used.

**T AMBIENT:** Press the **OK** key to adjust the ambient temperature reading. The display will show:  
Amb Temp Offset: 0C

Use the **UP/DOWN** keys to set the value, in °C, to add or subtract to the displayed ambient temperature.

**T PREHEAT:** This is the reading obtained from the second temperature input. It is optionally used to measure the temperature of the preheat air, if preheat air is used.



**ZERO TIME:** This is the countdown time for the autozero procedure. The autozero countdown should be at least 60 seconds. However, it need not be more than 120 seconds.

**SPAN TIME:** When carrying out a span calibration, you must introduce the span gas for an appropriate amount of time before the analyzer executes the span calibration. This setting, which is the same for all sensors, controls this time interval. The time is indicated in seconds, but a minimum of 5 minutes of span gas feeding is required for proper calibration of the electrochemical sensors. For span calibrating NDIR sensors 1 to 2 minutes of feed time is sufficient.

**SPAN LOCKOUT:** This controls access to the remaining span calibration menu options. Span lockout prevents accidental or mistaken calibrations. Span lockout is enabled and disabled by entering a 4-digit code.

**SPAN XXXX:** The remaining lines of the CALIBRATION MENU are used for carrying out span calibrations of the CO, NO, NO<sub>2</sub>, SO<sub>2</sub>, H<sub>2</sub>S, NDIR and Stack Draft sensors. For detailed use of these settings, please refer below.

## A. AUTOZEROING THE INSTRUMENT

When you turn the instrument on, wait two minutes to allow the analyzer to warm up before carrying out the autozero countdown.

To start the autozero procedure, press the **CALIB** button and select **ZERO ALL SENSORS**. Make sure that the analyzer pump is pulling in air.

At the end of the autozero period the E8500 reads the output of all gas sensors and sets them all to zero, with the exception of the oxygen that it sets to 20.9%. Consequently, it is very important that at the moment of "zeroing", the environment is clean from traces of carbon monoxide or other gases.

If no error messages appear at the end of the countdown, proceed with your measurements.

## B. SPAN CALIBRATION

**TO SPAN CALIBRATE THE ANALYZER, IT IS BEST TO USE ONLY SINGLE GAS MIXTURES WITH EITHER NITROGEN OR AIR BALANCE.**

You must always span calibrate the instrument every time you replace a sensor. At a minimum, you should perform a span calibration of the instrument once every 12 months. For greater accuracy you should check the calibration of the instrument before and after each emissions test. The parameters that require a span calibration are: carbon monoxide, carbon dioxide, nitric oxide, nitrogen dioxide, sulfur dioxide, hydrogen

sulfide, hydrocarbons, and draft. You can carry out all span calibrations in sequence or just one, if you wish.

### **Span calibration using your own gas**

If you wish to use your own span gas to perform span calibrations you must take certain precautions in order to calibrate the sensors properly.

Notice that you will need a number of certified gas cylinders. Make sure that you use a bypass flow meter as shown, in order to supply an adequate flow of span gas without developing excessive or insufficient pressure on the sensors. The accessory ensures proper gas flow to the E8500.

For greatest accuracy it is recommended that you use a span gas value close to the emission concentration you expect to measure.

Use a piece of tubing to connect one end of a T-junction of the calibration accessory to the E8500 probe. Connect the other end of the T-junction with a piece of flexible tubing to the gas cylinder outlet, past the gas regulator and shutoff valve.

You must not feed gas to the E8500 under pressure and you must not starve the E8500's pump for gas. When feeding the gas, you must maintain a reasonably constant pressure, near ambient pressure. This is a requirement of all diffusion-type electrochemical sensors.

Make sure the concentration of the calibration gas is within the range of each sensor. Do not use gas that will over-range the sensor.

The CO span gas can be in the range of 30 - 2000 PPM, 2% accuracy with balance nitrogen, preferably.

The NO span gas can be in the range of 10 - 2000 PPM, 2% accuracy with balance nitrogen, required.

The NO<sub>2</sub> span gas can be in the range of 10 - 500 PPM, 2% accuracy with balance nitrogen or air.

The SO<sub>2</sub> span gas can be in the range of 10 - 2000 PPM, 2% accuracy, with balance nitrogen, preferably.

The H<sub>2</sub>S span gas can be in the range of 10 - 200 PPM, 2% accuracy, with balance nitrogen, preferably.

For the NDIR option, the following ranges are allowed:

- The CO span gas can be in the range of 1.2 – 15.0% with balance nitrogen, preferably.
- The CO<sub>2</sub> span gas can be in the range of 9.0 – 20.0% with balance nitrogen, preferably.
- The hydrocarbons span gas can be in the range of 1000 - 30,000 PPM with balance nitrogen or air. Hydrocarbon gases such as methane, propane, and hexane can be used for calibration. Methane is used for factory calibrations.

## Calibration procedure

The following page illustrates the sequence of key strokes to carry out a span calibration of the analyzer. It is assumed that the instrument has been autozeroed and there have been no error messages.

**IMPORTANT: For the NDIR channels, the span calibration must be carried out within 3 minutes of autozeroing the analyzer.**

1. Connect the calibration apparatus and cylinder to the analyzer probe.
2. Press the MEASURE key and observe the target gas reading on the display, as you open the calibration cylinder valve. (If you are using the bypass flow meter, adjust the cylinder valve for a bypass flow rate of approximately 400 - 500 cc/min).

Observe the readings of the other gas parameters for evidence of cross sensitivity and also the oxygen reading for confirmation that there is no instrument leak, if the balance gas in the cylinder is nitrogen.

3. When the display reading for the desired gas has stabilized, press the **CALIB** key to enter the CALIBRATION MENU.
4. Scroll to the sensor that your are calibrating.
5. Enter the span value, printed on the span cylinder. Use the **UP, DOWN & OK** keys to change the span value. First set the hundreds digit, then press **OK** to advance the cursor to the tens digit, and repeat for the units digit.

6. Pressing **OK** again will bring up the DATA screen with the confirmation line:

PRESS OK TO SPAN

Press the **OK** key to begin the calibration. The unit will wait for the amount of time set as the span time. The display will show the span gas, the span gas value, and the time remaining.

7. When the calibration is finished, check the sensor accuracy with the calibration span gas.

You can minimize the span time if you wait for the reading to stabilize before executing the span calibration. If, instead, you execute the span countdown when you begin to feed span gas to the analyzer, then the recommended span time is set to 2 minutes for NDIR calibrations, 4 minutes or more for NO and CO calibrations, and a minimum of 10 minutes for NO<sub>2</sub> and SO<sub>2</sub> calibrations.

## Stack Draft Calibration

To obtain a span calibration of the draft sensor, connect a manometer to the end of the probe through a T fitting. Leave one side of the T open. Restrict the open side of the T with a suitable plug or valve. In the SPAN MENU, use the **UP / DOWN** keys to select a suitable draft calibration span between 5" H<sub>2</sub>O and 10" H<sub>2</sub>O. Press the **OK** key. The pump will be on and the display will read:

PRESS OK AT 10"

Very slowly start closing the intake valve of the apparatus and observe the manometer reading climbing. Set the valve opening as soon as the manometer is reading the same pressure as that selected on the display. Press the OK key again. The draft sensor will be calibrated to the value shown on the display.

## Velocity Calibration

To obtain a span calibration of the velocity sensor, connect a manometer to the end of the probe through a T fitting. In the SPAN MENU, use the **UP / DOWN** keys to select a suitable velocity calibration between 1.0" H<sub>2</sub>O and 3.0" H<sub>2</sub>O. Press the **OK** key. The display will read:

PRESS OK AT 1.0"

Increase the pressure using a pressure source, and observe the manometer reading climbing. When the manometer is reading the same pressure as that selected on the display, press the OK key. The velocity sensor will be calibrated to the value shown on the display.

---

## CHAPTER 11

---

### COMMUNICATIONS

The E8500 analyzer communicates wirelessly with a computer using its internal Bluetooth module. The E8500 is also supplied with an external Bluetooth module that connects to a USB port on the user's computer. The communication protocol is as follows:

BAUD RATE: 115000 baud  
FORMAT: 8 bits, 1 stop bit, no parity  
HANDSHAKE: None

#### A. EGAS SOFTWARE

You can enhance the performance and versatility of the E8500 by using the Emissions Gas Analyzer Software (EGAS) program. EGAS is available for Windows 95/98/ME/NT/XP/7.

The EGAS software is a robust package, and allows you to:

1. Monitor all emissions parameters simultaneously.
2. Record maximum, minimum, average and standard deviation for all emissions parameters.
3. Set alarms for every emissions parameter including recording the time duration that alarms have been exceeded.
4. Plot bar graphs and time plots of all parameters.
5. Select a variety of saving and printing options.
6. Enter custom fuel information.
7. Retrieve and save stored data.

Consult the EGAS manual for details on the software. The manual can be accessed by clicking on "Help" and then "How Do I..." in the EGAS software program.

---

## CHAPTER 12

---

### MAINTENANCE

The E8500 emissions analyzer is a sophisticated analytical instrument designed to perform accurate emissions measurements. However, because the analyzer is a portable, field use instrument that can be used in many environments, care must be taken to prevent physical and environmental abuse to help maintain trouble-free operation.

There are four components that will require periodic inspection or replacement. These are:

1. The disposable fiber line filter for particulates, located inside the drawer compartment of the analyzer
2. The disposable round disk condensation filter for moisture, also located inside the drawer compartment, behind the fiber line filter
3. Gas sensor periodic replacement
4. Printer paper replacement

#### **A. Fiber Line Filter and Condensation Disk Filter replacement**

The disposable fiber line filter is located inside the drawer compartment to the left of the chiller assembly. Its function is to prevent soot, smoke, & dust particles from reaching the analyzer pump and sensors. The disk condensation filter is also located in the same area behind the fiber line filter. Its function is to prevent any residual water from penetrating into the sensor area.

You must replace the filters when they become discolored or show any signs of cracks. **Never operate the analyzer without the filters.**

Frequency of filter replacement depends on the type of fuel burned in the combustion process being measured and the hours of active use.

To replace the filters pull out the drawer compartment and disconnect the two pieces of flexible tubing that hold the respective filters in place. If you are replacing the disk filter make sure that the filter's lettering is facing the front of the drawer.

## B. Condensation removal

Most of the water vapor in the stack gas will condense inside the extraction probe and sampling line. However, any additional excess water vapor will condense inside the thermoelectrically operated chiller, which is located in the front of the drawer compartment. All this water condensation will collect inside the small water trap that is located at the bottom of the chiller assembly. It will then be automatically removed by the peristaltic pump, which operates intermittently to discharge the water through the bottom of the analyzer.

## C. Sensor replacement

This should be an infrequent operation, since the sensors have a typical life of several years.

If you receive an error message for one of the sensors during instrument operation, do not attempt to replace the sensor immediately. Instead, wait a few minutes and then autozero the analyzer again. If you get an error message again, then investigate and determine if moisture has entered the sensor area. If so, wait a few hours for the moisture to evaporate and then autozero again. If the sensor failure persists then you must replace the sensor.

To access the sensor compartment you must remove the top section of the instrument case. **Before opening the analyzer case, first pull the drawer half way open and disconnect the wire connector right behind the back corner of the chiller fan.** The top section of the analyzer case is held to the bottom section by a total of four retaining screws. With both hands, slide off the vent covers on each side. Use a Philips screwdriver to remove both pairs of retaining screws (one pair on each side of the case). It is best to remove the bottom pair of screws first. Carefully lift the top of the instrument case together with the attached aluminum mounting shielding plate especially since the top & bottom cases pieces are connected with cables/wires. When the plastic case is open, be careful when near the main board because some of the resistors on the board can get significantly hot. The location of the gas sensors on the manifold is shown in the figure in Chapter 6.

To replace a sensor locate its correct position on the manifold. Carefully lift the small PC board that is mounted on top of the sensor. Grab the sensor with your fingers and lift it twisting it out of its bayonet fitting.

Take a new sensor. Remove any springs that may be shorting the sensor pins. Install it on its mount and connect the small PC board on top of it.

Replace the top section of the case and secure it with the four screws.

Wait the following time periods before autozeroing the analyzer:

O <sub>2</sub> SENSOR	10 minutes
CO SENSOR	30 minutes

NO SENSOR	24 hours
NO <sub>2</sub> SENSOR	30 minutes
SO <sub>2</sub> SENSOR	30 minutes
H <sub>2</sub> S SENSOR	30 minutes

Span calibrate the sensor as explained in Chapter 10. If you are installing a pre-calibrated sensor, use the following procedure:

- 1) While holding the **SETUP** key, press the **MEASURE** key three times. The display will show the sensor factors.
- 2) Press the **DOWN** key until you reach the appropriate sensor then press OK.
- 3) Use the **UP / DOWN** keys to enter the correct factor, digit by digit starting with the hundreds digit, press **OK** to move through the tens, ones, and tenths digits.

#### D. Printer paper replacement

The external printer uses a high quality 2" thermal paper. Keep any spare paper rolls in a cool dark place to prevent paper discoloration.

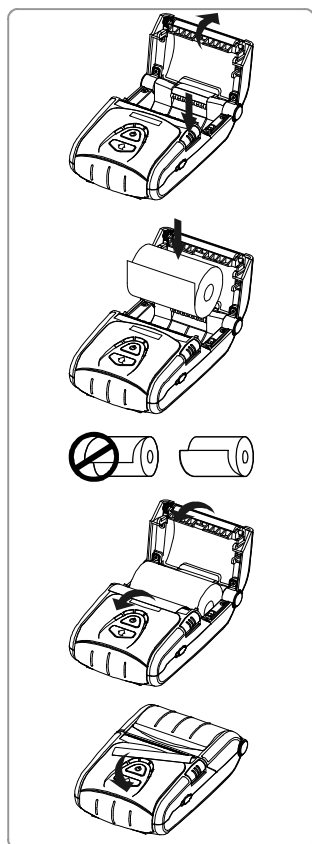

1. Press the open button on the printer to open the paper cover.
2. Insert the paper as shown in the image. Remove any remaining core of a used paper roll.
3. Make sure to align the paper roll properly.
4. Pull the paper out as shown in the image, and close the cover.
5. Tear off any excess paper in the direction of the side of the printer.



---

## APPENDIX A

---

### MODEL E8500 – SPECIFICATIONS

#### ANALYZER

##### 1. PHYSICAL:

Material: ABS plastic case with internal aluminum shielding

Dimensions (analyzer): 11.42" X 10.24" X 4.88"

Weight: (analyzer): 11 lbs. / 5 kg

Carrying case (analyzer & all accessories): 22 lbs. / 10 kg

##### 2. POWER:

7.2 Volt, 8 AH rechargeable NIMH battery pack

Operating time: 4 to 8 hours

110/240 VAC input, 12 V/2.5A fast charger

Charging time: 6 hours minimum

##### 3. DISPLAY:

2.6" x 1.4" 128 x 64 graphic, chip on glass (white backlit) LCD display.

Rotating display depending on analyzer case orientation

Small and large fonts, plus inverted background color for help messages

Battery condition & charger operation indicator

##### 4. WIRELESS REMOTE PRINTER

2" high resolution, high speed, graphic thermal printer, with charger, prints:

A. current set of data

B. stored data

C. periodic data printouts

D. calibration history and external messages

##### 5. INSTRUMENT PUMPS

A. Gas sample pump: high quality diaphragm pump with long life motor

B. CO dilution pump

C. Automatic condensate drain pump

##### 6. STORAGE

1000 internal memory storage tags, each tag stores one complete set of data

##### 7. COMMUNICATIONS

Bluetooth wireless: Class 1 (100m)

##### 8. SOFTWARE

EGAS™ Windows software

## SENSORS

### 1. EMISSIONS SENSORS – ELECTROCHEMICAL

SENSOR		RANGE	RESOLUTION	ACCURACY
CARBON MONOXIDE (CO)	Low Range	0-8000 ppm	1 ppm	<300ppm, 10ppm To 8000ppm, 4%
CARBON MONOXIDE (CO)	Dilution Auto-Range	4000-20000 ppm	1 ppm	>2000ppm, 10%
NITRIC OXIDE (NO)	Std. Range	0-4000 ppm	1 ppm	<100ppm, 5ppm To 4000ppm, 4%
NITROGEN DIOXIDE (NO <sub>2</sub> )	Std. Range	0-1000 ppm	1 ppm	<100ppm, 5ppm To 1000ppm, 4%
SULFUR DIOXIDE (SO <sub>2</sub> )	Std. Range	0-4000 ppm	1 ppm	<100ppm, 5ppm To 4000ppm, 4%
HYDROGEN SULPHIDE (H <sub>2</sub> S)	Std. Range	0-500 ppm	1 ppm	<100ppm, 5ppm To 500ppm, 4%

### 2. EMISSIONS SENSORS – NON-DISPERSIVE INFRARED (NDIR) SENSORS

SENSOR	RANGE	RESOLUTION	ACCURACY
HYDROCARBONS (HC or C <sub>x</sub> H <sub>y</sub> )	0 - 0.40 % 0.40 – 1.00 % 1.00 – 3.00 %	0.01 %	3% of Rdg.+ 0.01% 5% of Rdg. 8% of Rdg.
CARBON MONOXIDE (CO)	High Range 0%-10.00% 10.01%-15%	0.01%	0.02% or 3% Rdg. 5% of Rdg.
CARBON DIOXIDE (CO <sub>2</sub> )	0.0% - 16.0% 16.0% - 20.0%	0.1%	0.3% or 3% Rdg. 5% of Rdg.

### 3. OTHER SENSORS

SENSOR	RANGE	RESOLUTION	ACCURACY
OXYGEN (O <sub>2</sub> ) EC Sensor	0 – 25%	0.1%	0.1% Vol.
Stack Temperature Type K Tc	0 – 2000 °F (0 – 1100°C)	1 °F (1 °C)	5 °F (3 °C) or 2% of Rdg.
Ambient Temperature	0 – 150 °F (65 °C)	1 °F (1 °C)	3 °F (2 °C)
Stack Draft (piezoresistive)	+10" to -40" WC	0.1" WC	0.3" or 5% of Rdg.
Stack Gas Velocity	0 – 300 ft/sec	1 ft/sec	Meets EPA Method 2

**CALCULATED PARAMETERS**

<b>PARAMETER</b>	<b>RANGE</b>	<b>RESOLUTION</b>	<b>ACCURACY</b>
Combustion Efficiency	0 – 100%	0.1%	Calculated from fuel, O <sub>2</sub> , & dTemp
CARBON DIOXIDE (CO <sub>2</sub> )	0 – 99.9%	0.1%	Calculated from fuel and O <sub>2</sub>
Excess Air	0 – 1000%	1%	Calculated from fuel and O <sub>2</sub>
Oxides of Nitrogen (NO <sub>x</sub> )	0 -- 5000 ppm	1 ppm	NO + NO <sub>2</sub> Specs.
Emissions 1 (CO, NO, NO <sub>2</sub> , NO <sub>x</sub> , SO <sub>2</sub> , H <sub>2</sub> S)	0 – 2500 mg/m <sup>3</sup>	2 mg/m <sup>3</sup>	Calculated from ppm, O <sub>2</sub> , & fuel
Emissions 2 (CO, NO, NO <sub>2</sub> , NO <sub>x</sub> , SO <sub>2</sub> , H <sub>2</sub> S)	0.00 – 99.99 lbs/MBTU	0.01 lbs/MBTU	Calculated from ppm, O <sub>2</sub> , & fuel
Emissions 3 (CO, NO, NO <sub>2</sub> , NO <sub>x</sub> , SO <sub>2</sub> , H <sub>2</sub> S)	0.00 – 99.99 g/bhp-hr	0.01 g/bhp-hr	Calculated from ppm, O <sub>2</sub> , & fuel
Emissions 4 (CO, NO, NO <sub>2</sub> , NO <sub>x</sub> , SO <sub>2</sub> , H <sub>2</sub> S & CO <sub>2</sub> )	0 .00 – 99.99 lbs/hr 0-99.99 tons/day (CO <sub>2</sub> )	0.01 lbs/hr 0.1 tons/day (CO <sub>2</sub> )	Calculated from velocity, ppm, O <sub>2</sub> , & fuel
Stack Gas Flow Rate	0 – 65000 cfm	1 cfm	Calculated from velocity, ppm, O <sub>2</sub> , & fuel

---

## APPENDIX B

---

### FIRMWARE PROGRAMMING

On occasion it may be necessary to update the internal software of the analyzer, also known as the firmware. The firmware can be updated in the field with the use of a computer connected to the E8500 analyzer. Firmware updates can be requested from the factory. The current firmware version is displayed on the second status screen.

#### Updating the firmware

1. Open the drawer of the analyzer and locate the programming switches on the right edge of the PC board. There are 2 miniature slide switches on a black block.
2. Connect communications between the E8500 and the computer. Run the firmware update. The program will backup the analyzer's settings.
3. When prompted, toggle the switches on. The firmware will now be reprogrammed. This will take 2 to 3 minutes.
4. When prompted, toggle all the switches off and replace the batteries and cover. The analyzer's settings will be restored.
5. Autozero the analyzer. Check the span calibration of all sensors.

---

## APPENDIX C

---

### REPLACEMENT PARTS

<b>PART NUMBER</b>	<b>DESCRIPTION</b>
E85-9078	Printer Paper Roll
EE650072	Line Filter
EE650077	Condensation Disk Filter
AAA32-240	O2 Sensor
AB510-W0X	CO Sensor
AF508-W0C	NO Sensor
AG526-W00	NO2 Sensor
AD527-W04	SO2 Sensor
E851010	H2S Sensor
E851015	NDIR Bench with CO2, CxHy, & High CO Sensors
E852010	Rechargeable Battery Pack
E852020	AC Charger, 100-240VAC/50- 60Hz with 12V Output
E852130	Bluetooth Adapter/Dongle