



TABLE OF CONTENTS

System	A1
Carrying case.....	A1
Measuring units.....	A2
Brackets	A2
Display unit.....	A3
Auto off functions / Program menu / Loss of signal	B1
Main menu.....	B1
Help menus	B2
Store measurement result.....	B2
Restore and Delete measurements.....	B3
Print and Send measurement	B4
Measurement value filter.....	B4
Mounting the measuring units.....	B5
Aim the beam (target mode).....	B5
Rough alignment.....	B6
Entering the distances (Horizontal shaft alignment)	B6
Softfoot program	C1
Horizontal program.....	C2
Easy-Turn™ program	C3
Measurement result explained	C4
Measurement result with tolerance check	C5
Measurement result with thermal growth compensation.....	C6
Cardan program.....	C7
Vertical program	C9
Offset and Angle program	C10
Values program.....	C11
Machine Train program.....	C12
Straightness program.....	C15
Straightness Plus program	C16
Facts about laser and psd detector	D1
Conditions for shaft alignment.....	D2
Thermal gradients.....	D3
Technical terms	D3
Tolerances for shaft alignment	D4
Problem solver / Maintenance	D5
EasyLink™ PC software for Windows®.....	D6

DECLARATION OF CONFORMITY

Equipment: Easy-Laser® *Extreme*™

Damalini AB declares that the Easy-Laser® product *Extreme*™ is manufactured in conformity with national and international regulations.

The system complies with, and has been tested according to the following requirements:

EMC Directive: 89/336/EEC
Low Voltage Directive: 73/23/EEC including amendments by Directive 93/68/EEC.

Easy-Laser® *Extreme*™ complies with the harmonized European Standards:

Directive 94/9EC, ISO9001:2000

Pr EN 13980: 2002 E

CENELEC EN 50014: 1997 +A1, A2: 1999

CENELEC EN50020: 2002

Ex Classification: EEx ib IIC T4, Atex-code: II 2 G

Ex Certificate Number: NEMKO 06ATEX1051X

IECEX NEM 06.0002X

Laser Classification: EUROPE SS-EN-60825-1-1994

USA CFR 1040.10/11 - 1993

2006-06-19, Damalini AB

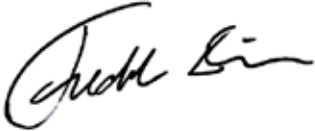

Fredrik Eriksson, Quality Manager

CE 0470

Damalini AB's quality system is approved by Nemko (Notification Number Nemko 05ATEX44280) as follows: "Nemko AS, notified body number 0470 for Annex VII in accordance with Article 9 of Council Directive 94/9/EC of March 1994 notifies to the applicant that the actual manufacturer has a product quality system which complies with Annex VII of the Directive."

DISCLAIMER

Damalini AB and our authorized dealers will take no responsibility for damage to machines and plant as a result of the use of Easy-Laser® measurement and alignment systems.

Even though great efforts are made to make the information in this manual free from errors, and to make the information complete for the user, there could be things we have missed, because of the large amount of information. As a result of this, we might change and correct these things in later issues without further information. Changes to the Easy-Laser® equipment may also affect the accuracy of the information.

SAFETY PRECAUTIONS

Easy-Laser® is a laser instrument in laser class II with an output power less than 1 mW, which only requires the following safety precautions:

- ! Never stare directly into the laser beam
- ! Never aim the laser beam at anyone else's eyes.

NOTE! Opening the laser units can result in hazardous radiation, and will invalidate the manufacturer warranty.



- Always turn off the power of the drive machine before you start working.
- Always read and follow the operating instructions.
- Opening the housing of the measuring unit will invalidate the Ex rating, voids warranty and may result in hazardous light exposure.
- Opening the display unit will invalidate the EX rating and voids warranty.
- Use the equipment only in the intrinsic safety zone for which it has been certified, EEx ib IIC T4 - II 2G.
- The equipment is designed for use in ambient temperature between 0 °C and +40 °C.
- Never remove or replace the batteries of the display unit in potentially explosive atmosphere.
- Only use the type of battery specified.
- Never connect any equipment to the RS232 connector in potentially explosive atmosphere.
- All repair work should be taken care of by an authorized Easy-Laser® repair shop.



SYSTEM

Complete system (Part No:12-0340). Includes:

- 1 Display unit (Part No:12-0336)
- 1 Measuring unit M (Part No:12-0334)
- 1 Measuring unit S (Part No:12-0335)
- 2 Shaft brackets with chains (Part No:12-0337)
- 2 Extension chains (Part No:12-0363)*
- 8 Rods 120 mm (Part No:01-0873)*
- 1 Hexagon key for battery lid (Part No:03-0699)*
- 1 Rod tightening tool (Part No:01-0048)
- 3 Cables with push-pull connectors, 2 m (Part No:12-0074)
- 1 Cable with push-pull connectors, 5 m (Part No:12-0108)
- 1 Measuring tape (Part No:12-0012)
- 1 Manual
- 1 EasyLink™ PC program
- 1 Carrying case (Part No:12-0339)
- 1 USB adaptor (Part No:03-0722)
- 1 Null modem cable (Part No:03-0333)

*Located in the tool pocket

TECHNICAL SPECIFICATIONS

Measuring distance 20 m
Ambient temperature 0–40 °C
Weight total in case 7.3 kg

Ruggedized, intrinsically safe, IP66/IP67 protected shaft alignment system.



CARRYING CASE

Aluminum case with conductive contoured foam padding. Approved for Ex environments.

TECHNICAL SPECIFICATIONS

Weight 3 kg
Dimensions 490x350x200 mm



MEASURING UNITS

Measuring units with PSD detector (20x20 mm), electronic 360° inclinometer and laser diode in one housing.
 Delivered as a pair with S-unit and M-unit (for Stationary and Movable machine).

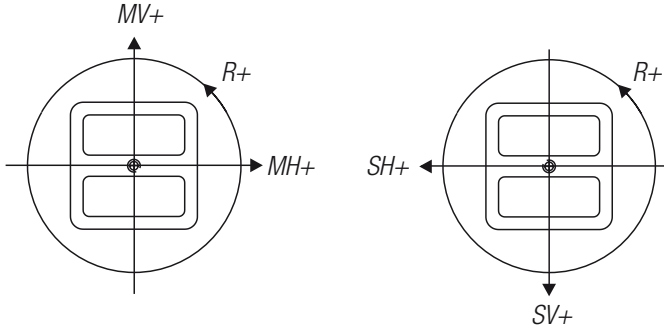

Measurement values when moved according to arrows.

Adjustment screws (Appr. ±3 revolutions = ±3° angular adj.)

Adjustment screw (near the PSD for Vertical adj.)

Adjustment screw (near the Laser for Horizontal adj.)

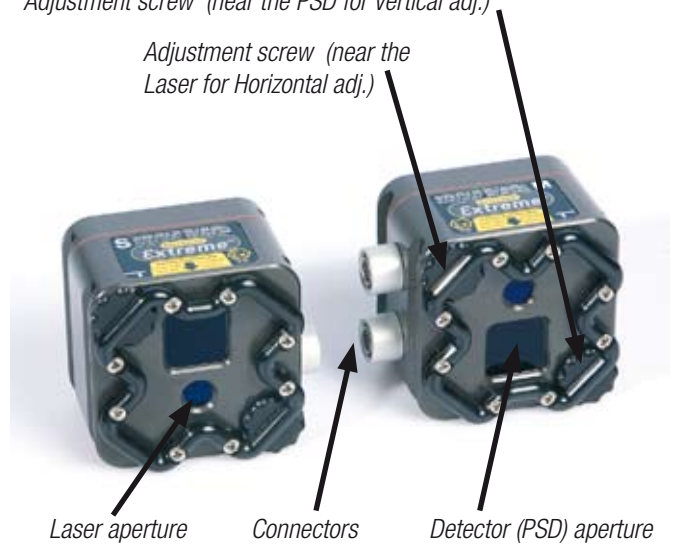

Laser aperture

Connectors

Detector (PSD) aperture

TECHNICAL SPECIFICATIONS

Detector type	2-axis PSD
Detector size	20x20 mm
Linearity	Better than 1%
Laser diode	< 1 mW Class 2
Laser wavelength	635-670 nm
Inclinometer resolution	0.1°
Thermal sensor resolution	0.1°
Dimensions	75x65x52 mm
Housing material	Hard anodized aluminum
Weight	220 g
Water and dust protected	IP66 / IP67



Label on measuring units (back side) 2.



Label on measuring units (back side) 1.

(Marking labels consist of polyester)



Labels on measuring units S and M respectively (top).

BRACKETS

Bracket with pre-mounted chain, locking frame and spare locking screw which also functions as a stopper for the frame.

TECHNICAL SPECIFICATIONS

Shaft diameter	20-450 mm, extension chain for larger diameters
Material	Stainless steel, including the chain
Weight	800 g

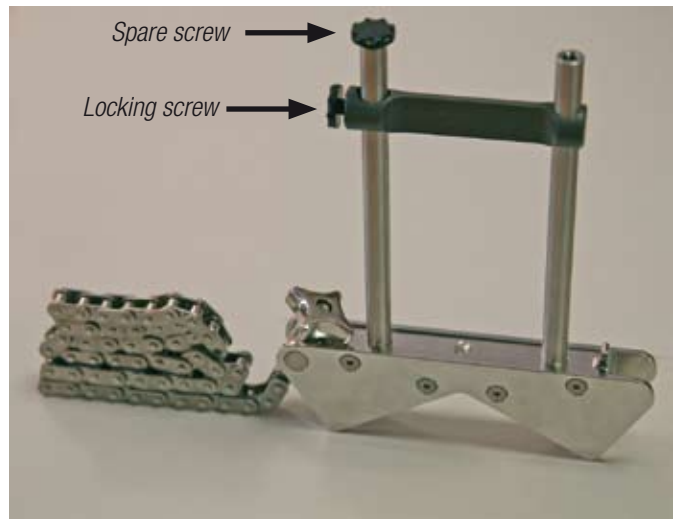

Spare screw

Locking screw

DISPLAY UNIT

Battery operated unit.

Membrane keyboard with 16 buttons.

Measurement data storage.

Serial port for printer and PC communication.

Note: Do not connect the serial port in a potentially explosive atmosphere.

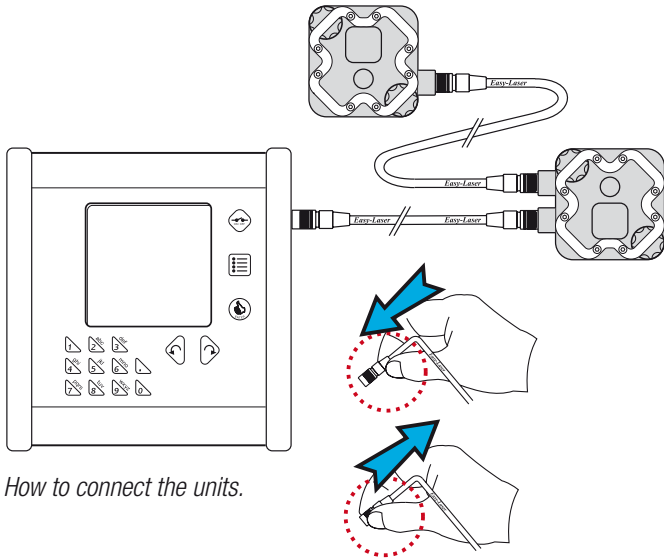

How to connect the units.

TECHNICAL SPECIFICATIONS

Housing material	Anodized aluminum / Chrome plated aluminum
Keyboard	16 membrane buttons
Display	4.5" LCD
Battery type	Duracell Procell Alkaline Mn1400 (PC1400)LR14 1.5 V
Operating time	20 hrs continuously
Displayed resolution	Changeable, down to 0.001 mm (0.05 mil)
Memory	Stores up to 1000 measurements
External connector	RS232, 9P PC or printer
Dimensions	183x155x45 mm
Weight	1000 g
Water and dust protected	IP66 / IP67

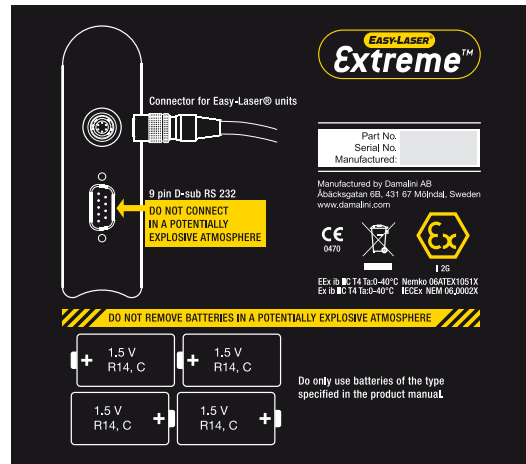

Back side label of display unit. (Marking label consists of polyester)

Replacing batteries. When batteries are low (see B1, battery condition), the batteries need to be replaced.

Follow this procedure when replacing the batteries:

1. Do not remove batteries in a potentially explosive atmosphere.
2. Only use batteries Duracell Procell Alkaline Mn1400 (PC1400) LR14 1.5 Volt
3. Press and hold the lid close to the unit, then use the hexagon key from the tool pocket and unscrew the two screws about 4 mm. Release the lid.
4. When closing, press the lid to completely compress the springs, then tighten the two screws.



AUTO OFF FUNCTIONS / PROGRAM MENU / LOSS OF SIGNAL

During power-up, the program version is shown for about 2 seconds.

Then the measurement program menu is shown. Start a program by entering the appropriate number.

When a program is running, pressing  will exit the program and return to Program menu.

Pressing  in the Program menu will turn the Display unit off.

If no program is started, the Display unit will be turned off after 10 minutes.

When a program is running, but no buttons are pressed, the Display unit will return to the Program menu when the Auto Off Time expires (see B1).

No signal

Current measurement values becomes +++++ when loss of signal, for example if the laserbeam is interrupted.

When connection failure, for example if cable isn't connected, measurement values become -----

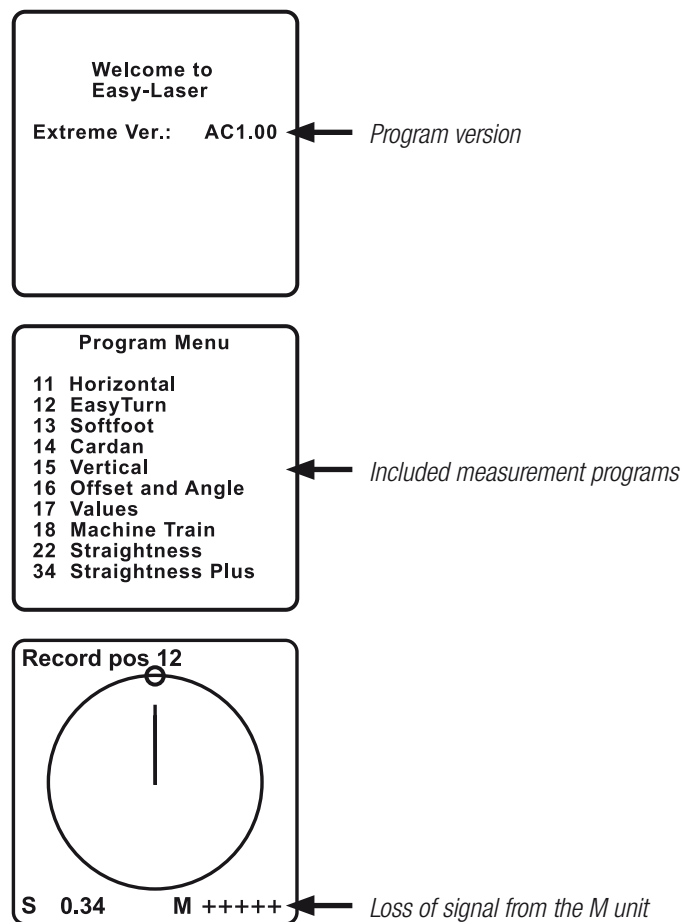

MAIN MENU

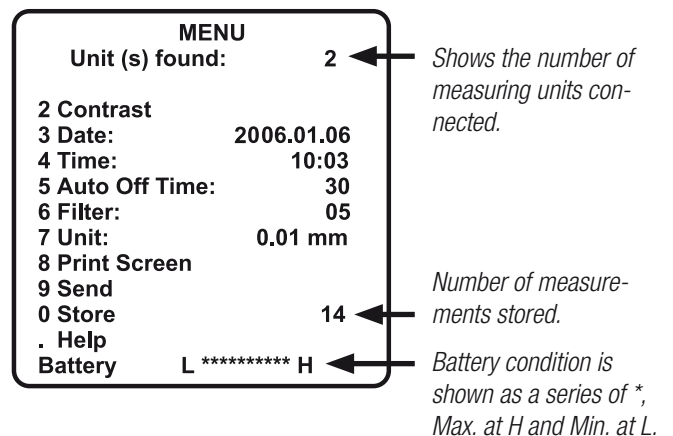

The menu for main settings, print and store is shown when pressing . This can of course be done during measurement. When the display unit is shut off, all the settings will remain (except measurement filter value and tolerance checked display of measurement result). *Press corresponding numeric key to change or execute settings. Only available choices are shown.*



- 2 Each touch changes the Contrast of the display to one of ten steps.
- 3 Set the current Date in the system clock.
- 4 Set the current Time in the system clock.
- 5 Set the time until Auto-Off between 10 and 99 minutes. 00 disables Auto-Off.
- 6 Set Measurement Filter Value between 0 and 30. (see page B4)
- 7 Toggle the units of measurement between 0.1, 0.01, 0.001 mm: 5, 0.5, 0.05 mils: 5, 0.5, 0.05 thou.
- 8 Print the previous screen on a connected printer.
- 9 Send the measurement result to a connected printer or PC.
- 0 Store and Restore measurement results.
- . Help: Shows available program choices at each step of the measurement program procedure.
-  Return.

HELP MENUS

Help menus are available at most steps in the measurement program procedure. "Help menu" is a display page that shows available button choices (direct commands). This is for example usable when the printed manual is not available.

1. To show current Help menu, first press 
2. Then press , and the current help menu is shown.
3. *NOTE! The shown button choices are only active in the measurement procedure, and not when the Help menu is shown. Therefore, return to the Main menu and the measurement procedure by pressing Menu-button twice. Then press appropriate numeric key.*

< **Prev. Page**
 > **Next Page**
 0 **Set ref. points**
 1 **Clear ref. points**
 4 **Graph**
 9 **Remeasure**

Example from Straightness program when the measurement result is shown digitally. Press  and the result will be shown graphically instead.







STORE MEASUREMENT RESULT



The measurement result with date, time and description can be stored in the internal memory, and will be kept even when the display unit is shut off. The stored result can later on be reviewed on the display, printed or transferred to a PC.

Date and time are stored automatically. When you type the letters and figures in, the cursor jumps to the next position after 1 second. Repeated pressings will give the next letter or figure.

The memory is very large. 1000 shaft alignments or 7000 measurement points can be stored. Occassionaly, if the memory is full the oldest measurement stored will be erased and a new result is stored.

Characters

-  blank _ - 1
-  A B C 2
-  D E F 3
-  G H I 4
-  J K L 5
-  M N O 6
-  P Q R S 7
-  T U V 8
-  W X Y Z 9
-  / 0
-  & () .

Example: press  three times and you have entered "Y".
NOTE! When entering values for machine measures the  button pressed before any figure will give a (-) sign.

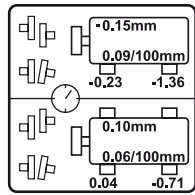

1. The measurement result is displayed...

2. Press the Menu-button 

MENU

Unit (s) found: 2

2 Contrast

3 Date: 2006.01.06

4 Time: 10:03

5 Auto Off Time: 30

6 Filter: 05

7 Unit: 0.01 mm

8 Print Screen

9 Send

0 Store 14

. Help

Battery L ***** H

3. Press  (Store)

TYPE LABEL

4. Enter a label (Max. 20 characters).

5. Finish and store by pressing 

RESTORE AND DELETE MEASUREMENTS

Restore a measurement by turning the system on and then press the Menu-button *before* starting any program. Choose *Restore* and each stored measurement is displayed with Date, Time and Label. The measurements are sorted in chronological order with the latest at the first position (number 1). Up to five measurements can be displayed at each time. Enter the corresponding number for the measurement to be restored or deleted, then select desired function. When the data is displayed it can be printed or transferred to a PC. This is done as usual via the Main menu by pressing *Print* or *Send*.

1. Start the system 



2. Press Menu-button 

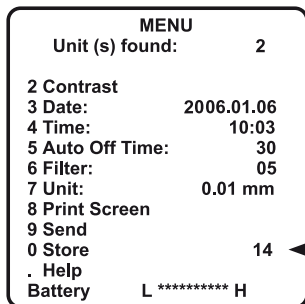

← Number of stored measurements.

3. Press **[0]** (Restore)

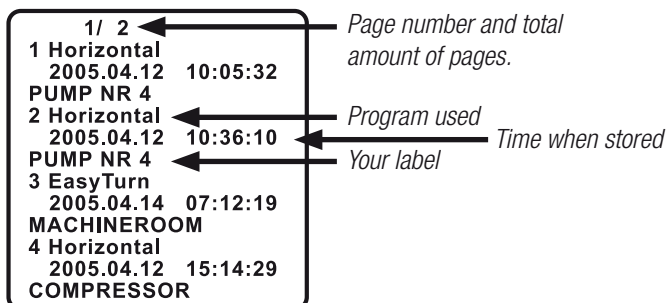

4. Press corresponding figure to display desired measurement.

[Toggle between pages with  ]

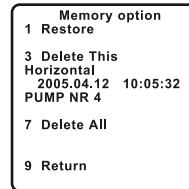

5. Select desired function:

Restore measurement **[1]**

Delete this measurement **[3]**

Delete all stored measurements **[7]**

Back **[9]**



The measurement result is displayed.
[Return to list by pressing **[9]**]

Press **[3]** to confirm deletion of this measurement.
[Return to list **[9]**]

Press **[7]** to confirm deletion of all stored measurements.
[Return to list **[9]**]

PRINT AND SEND MEASUREMENT

Two options are available for measurement data transfers. These are carried out from the Main menu. The Print Screen command transfers a copy of what is shown on the display. Actually a screen-dump. The Send command transfers a complete set of information, in text mode. Transferring a previously stored measurement also includes description if available. When using the programs Offset and Angle and Values, measurement values can be sent directly from the detector to the serial port. The EasyLink™ software (or other similar terminal program) can receive the data sent. (For installation of EasyLink™, see page D6.)

1. Press 
2. Press  (print) or  (send)

Easy-Laser® is equipped with an RS 232 C, 9 pin D-sub connector for printer or PC. The printer must be Epson compatible to achieve a proper graphic printout. Port settings: 9600 Baud, no parity check, 8 data bits, 1 stopbit. For USB connection, use the RS232/USB adaptor.

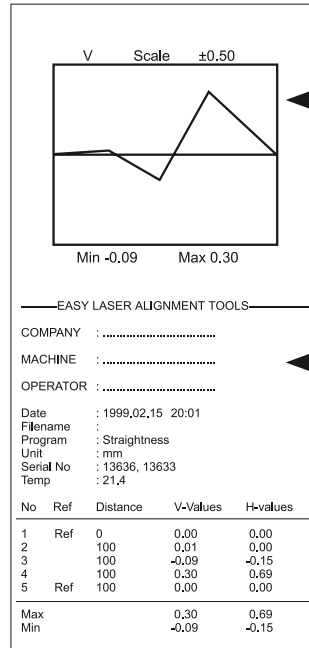

Print Screen performs a graphic screen dump.

Send transfers a complete set of information about current measurement in text mode. The serial number of the equipment used and the measurement temperature will also be specified.

Example: printout from Straightness-program.

MEASUREMENT VALUE FILTER

If the laser beam passes through air with varying temperature, this may influence the direction of the laser beam. If measurement values fluctuate, this could mean unstable readings. Try to reduce air movements between laser and detector by, for instance, moving heat sources, closing doors etc. If the readings remain unstable, increase the filter time (more samples will become available to the statistical filter). In the Main menu, choose a filter value between 1 and 30. Use as short a time as possible that still produces acceptable stability during the measurement.

Filter value 0=filter not active.

Note! Settings for filter value are not saved when the Display unit is turned off.

Always ensure a good measurement environment.

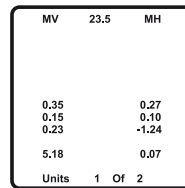

1. Unstable values...

2. Press 

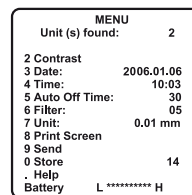

3. Press  (filter).

4. Select suitable value.

5. Press  to return to measurement.

When measurement values are registering, "WAIT 5" is displayed, where the number corresponds to chosen filter value and counts down to 0. NOTE! Do not interrupt the laserbeam or move the detector before countdown is complete.

MOUNTING THE MEASURING UNITS

Two set of grooves make two possibilities for the mounting of the measuring units (alternative A or B, see pictures). Which to use depends on how much space there is around the coupling.

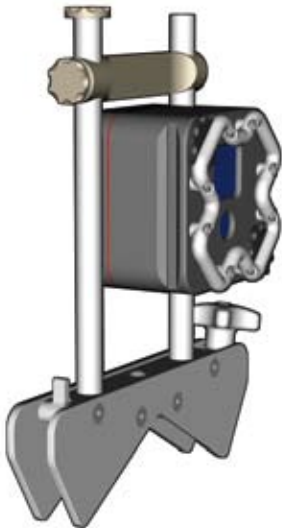

A. Back mounted



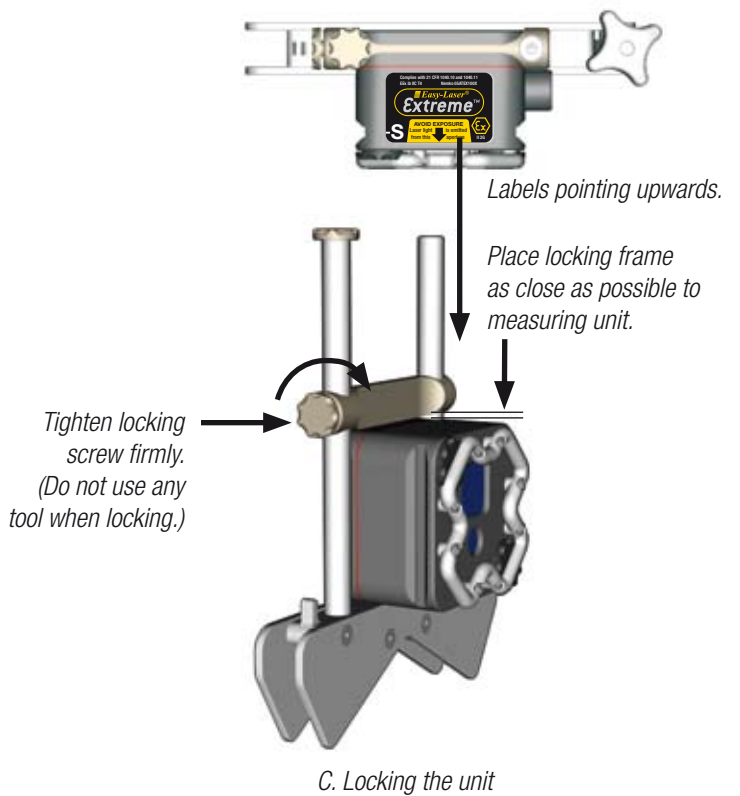

B. Front mounted



AIM THE BEAM (TARGET MODE)

In all measurements the whole laser spot must hit within the PSD aperture. Follow this procedure:

1. First of all check that the S and M units are approximately at the same level (the distance from shaft center).
2. Enter the distances as asked by the program (see page B6).
3. Press **8** and the display now represents the M unit PSD surface, with a cross at the center. The circle shows the S laser position. Turn the adjustment screws on the S unit to move the laser spot approximately at the center.
4. Toggle M-S displaying with  or , then adjust the M laser spot at the center.
5. Press **8** to exit Target mode.

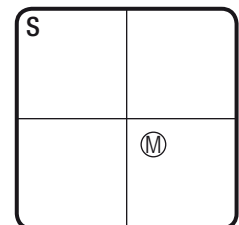
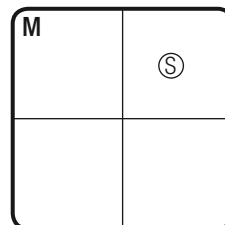

The range is about ± 8 mm (± 0.3 ") and the smallest visible step is about 0.15 mm (6 mils).

ROUGH ALIGNMENT

When turning the shafts with measuring units mounted, the laserbeams will project arcs, where the centres will coincide with the centres of the shafts. During the turning the laser beams will move on the detector surfaces. When the alignment is poor the beams may travel outside the detectors. If this happens you will have to do a rough alignment first. Preparation: mount the equipment.

Enter the distances as asked by the system, then press **8**.

1. Turn shafts with measuring units to the 9 o'clock position. Adjust the laserbeams to the centre of the PSDs.
2. Turn shafts with measuring units to the 3 o'clock position.
3. Check where the laser hits, then adjust the beams half the travel in direction to the centre of the PSDs (see picture below).

[Toggle S-M unit displaying with  ]

4. Adjust/move the movable machine so that the laser beam hits the centres of both the PSDs. Done.

The arc described by the **laserbeam from the M-unit during turning.**
(Only S-unit shown, faced from the M-unit)

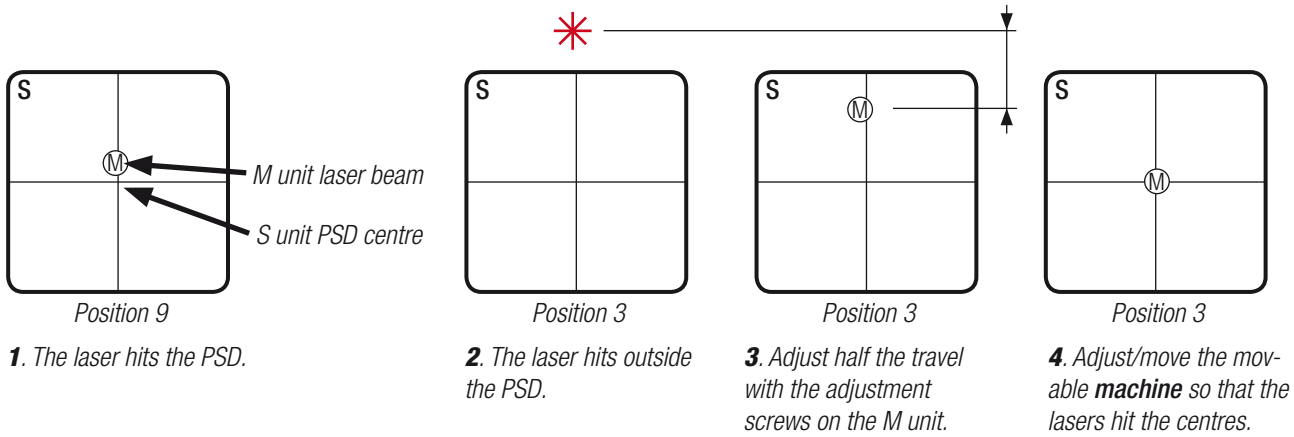
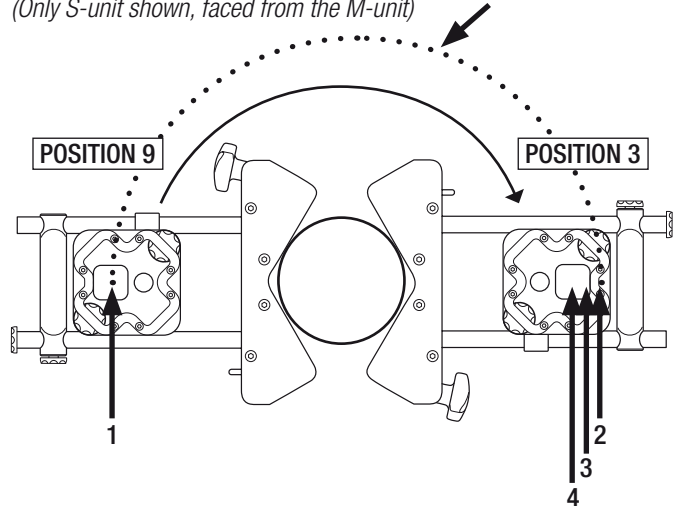

ENTERING THE DISTANCES (HORIZONTAL SHAFT ALIGNMENT)

When you select a shaft alignment program the system asks for the distances between measuring units, coupling and feet. Enter the distances according to the pictures below. The system can handle distances between 1 and 32000 mm (1260 Inch).

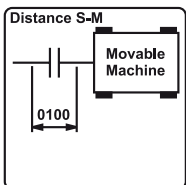

Type the distances in by using the numerical keys.

Confirm each distance with 

[Redo with ]

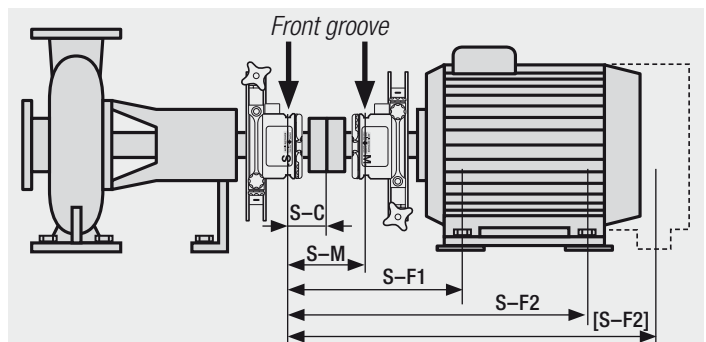

S-M=distance between measuring units.

S-F1=distance between stationary detector (S) and feetpair 1 (F1).
(To enter a negative [S-F1] value, first press **[-]** for minus sign, then enter the value.)

S-C=distance between S and Center of coupling (if the coupling is in the middle between the measuring units, just press "Enter". If not, enter the right value).

S-F2=distance between S and F2 (must be longer than S-F1).

[S-F2]=if the machine has three pairs of feet, you can add this distance after finished measurement, and let the system calculate a new shimming and adjustment value for this pair of feet (see page G2).

SOFTFOOT PROGRAM

Before you begin a shaft alignment you should do a softfoot check. Previous shimming or a twisted machine bed may cause the machine to rest unevenly on the feet (=softfoot). The result from this measurement program displays the difference between tightened and loosened bolt. You can go from softfoot check directly to the Horizontal or EasyTurn™ shaft alignment program and keep the entered machine distances. Procedure: Tighten all bolts, mount the measurement equipment, start the softfoot program, enter the distances, start the measurement. *Note! the "Store" function can not be used in this program.*

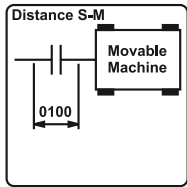
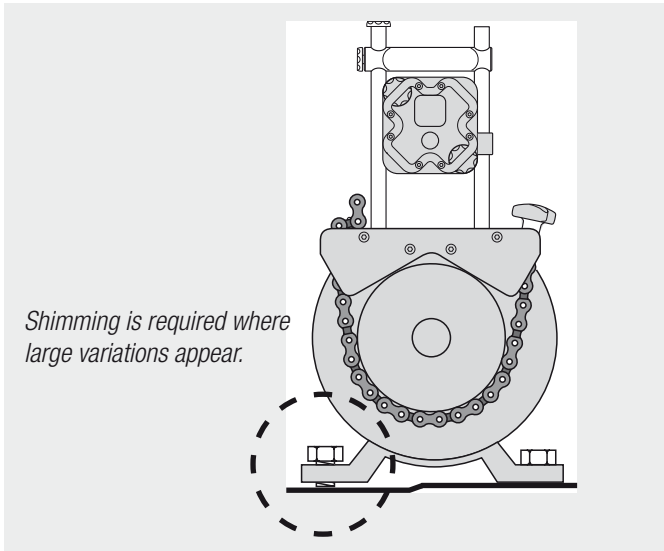

1. Enter the distances when prompted on the display.

Confirm
 [Redo]

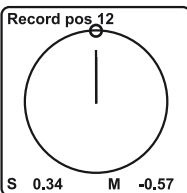

2. Turn to position 12.

Aim the beams.
 Confirm
 [Back]

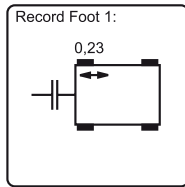

3. Release and tighten first bolt.

Confirm
 Redo step 3 for each of the other feet (foot 2-4).

[If desired, zero set with]

[Back]

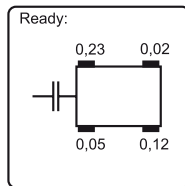

4. The result for all feet are displayed. Shim the foot/feet with the highest value.

[Remeasure]

[To go directly to alignment, and keep the entered distances, press]

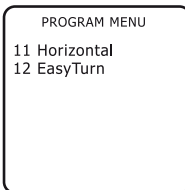

[Select desired program.]

HORIZONTAL PROGRAM

With the Horizontal program you read values at the 9, 12 and 3 o'clock positions. That is, you turn the shafts a total of 180°. Measurement procedure: mount the equipment, start the Horizontal program, enter the distances, if necessary make a rough alignment, start the measurement.

For the positioning of the units, built-in electronic inclinometers detect the angular position and displays this as hands on a clock.

Important: The Horizontal program requires that the units are in the right position (9, 12, or 3).

NOTE! Check in each position (9, 12, 3) that the laser beams hit the detectors by pressing **[8]**.

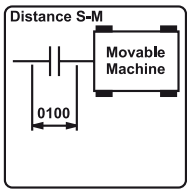
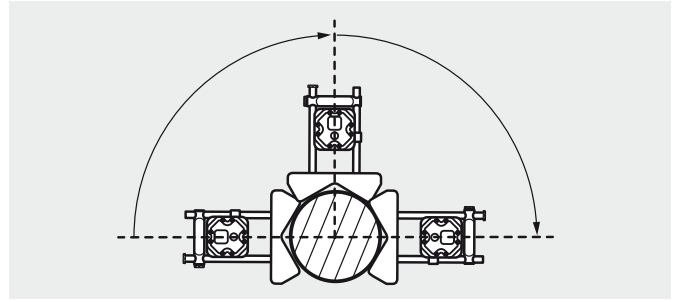

1. Enter the distances, as prompted by the system.

Confirm each distance with

[Redo with]

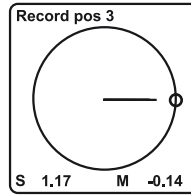

4. Turn shafts to the 3 o'clock position. Record last value.

Confirm

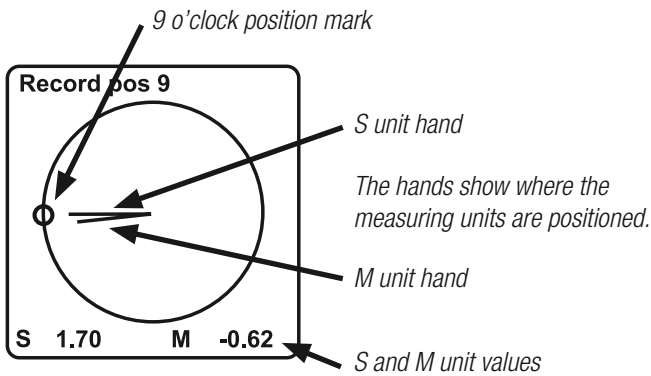

2. Turn the measuring units/shafts according to the hands into the 9 o'clock position. Aim the beam. Record the first measurement value.

Confirm

[Redo]

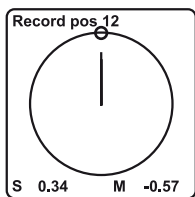

3. Turn shafts to the 12 o'clock position. Record second value.

Confirm

[Redo]

Horizontal values updates continuously.

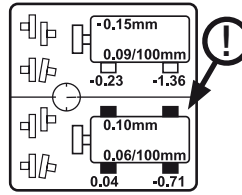

Vertical values updates continuously.

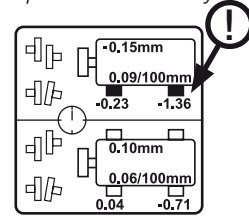

5. The result is displayed. Horizontal and vertical positions for the movable machine are shown both digitally and graphically.

See page C4, "Result for Horizontal machine" for detailed information of the result display.

[By pressing when the measurement values are displayed, a new S-F2 distance can be entered for a third pair of feet. New F2-values (adjustment and shimming) will be calculated for this pair of feet and displayed.]

[Press **[9]** to do a new measurement from the 9 o'clock position]

[Press **[4]** to select tolerance checked displaying of the measurement result. See page C5.]

[Press **[6]** to set values for Thermal growth compensation. See page C6.]

An indicator for measurement direction () in the middle of the display shows that the measuring units now have to be in the 3 o'clock position. The horizontal values now updates continuously (live), indicated by filled foot symbols. Button **[5]** changes between Horizontal and Vertical live values. The indicator for measurement direction shows in which position the measuring units have to be placed (3 or 12 o'clock) and filled foot symbols shows which direction is displaying live values.

EASY-TURN™ PROGRAM

With the EasyTurn™ program shaft alignment is possible even if machine parts or piping interfere with 180° of shaft rotation. You can start the measurement anywhere on the turn, and the smallest angle needed between measurement points is 20°.

Procedure: mount the measurement equipment, start the EasyTurn™ program, enter the distances, if necessary do a rough alignment, start the measurement.

Built-in electronic inclinometers detect the angular position of the units. The angles are displayed as hands on a clock (angular marks). If machines are severely misaligned, the beam from the M-unit may not strike the S-unit detector surface. The second and third positions of the M-unit are therefore dependent on the laserbeam from the S-unit.

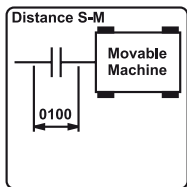
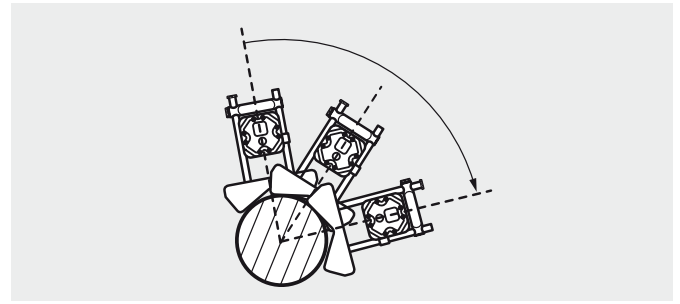

1. Enter the distances, as prompted by the system.

Confirm each distance with

[Redo with]

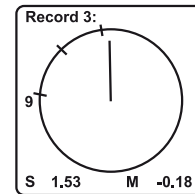

4. Third reading. Similar to second reading. Turn shafts beyond the 20° mark.

Confirm

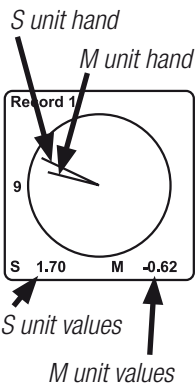

2. Place the measuring units so that the marks are on top of each other (or almost on top).

Aim the beams.

Record the first measurement value.

Confirm

[Back]

Horizontal values updates continuously.

Vertical values updates continuously.

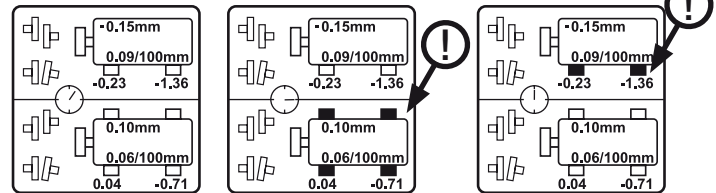

5. The measurement result is displayed. The Horizontal and Vertical positions for the movable machine are displayed both digitally and graphically.

See page C4, "Result for Horizontal machine" for detailed information of the result display.

[By pressing a new S-F2 distance can be typed in. A new F2-value will then be calculated and displayed.]

[Press **9** to do a new measurement from first position "9"]

[Press **4** to select tolerance checked displaying of the measurement result. See page C5.]

[Press **6** to set values for Thermal growth compensation. See page C6.]

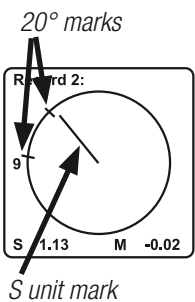

3. Second reading. Turn the shafts at least 20° in any direction (displayed as small marks on the circle). If the shafts are uncoupled; first turn the shaft with the S-unit, then press **8**, turn the shaft with the M-unit so that the S-laser hits the PSD.

Press **8** again, then:

Confirm

[Redo first value]

The foot symbols are filled for the horizontal or vertical values when the measuring units are positioned 3, 6, 9 or 12 o'clock (±2°). Then the values are updated continuously in each direction. The indicator for measurement direction () in the middle of the display shows the actual position of the units.

MEASUREMENT RESULT EXPLAINED

The result from a measurement of a horizontal machine displays the position of the movable machine, and how to shim and adjust to align the machine. (Note! The indicator for measurement direction works differently for the Horizontal and the EasyTurn™ program. See below*.)

1. Read the values and decide if the machine needs to be aligned. If so:
2. Shim according to the vertical adjustment values.
3. Adjust sideways according to the horizontal values.

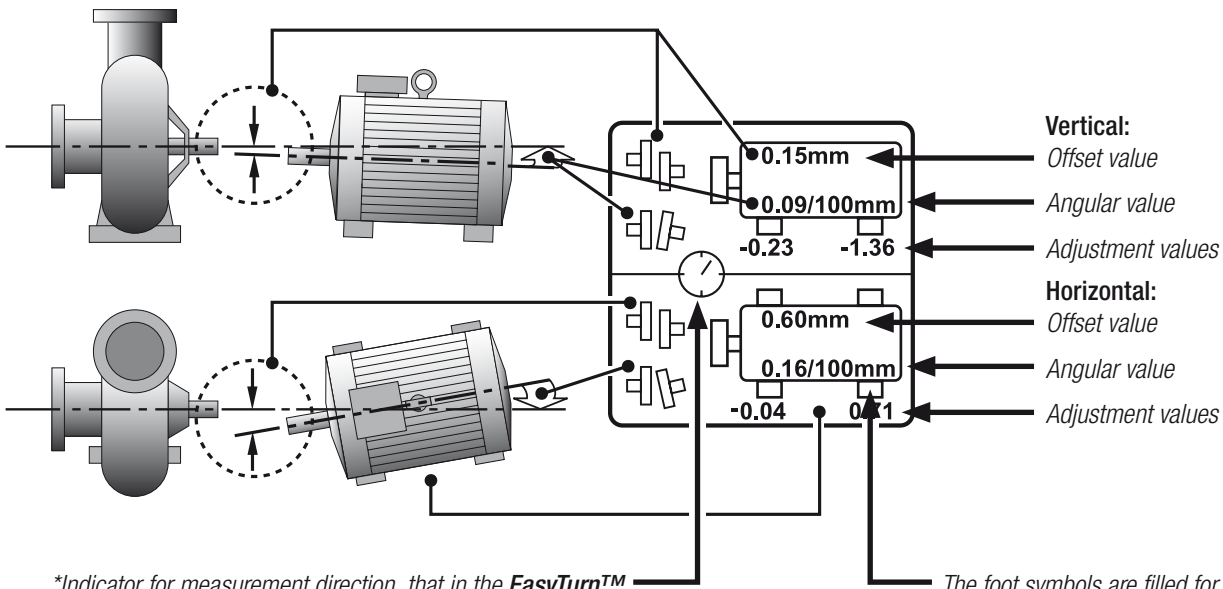
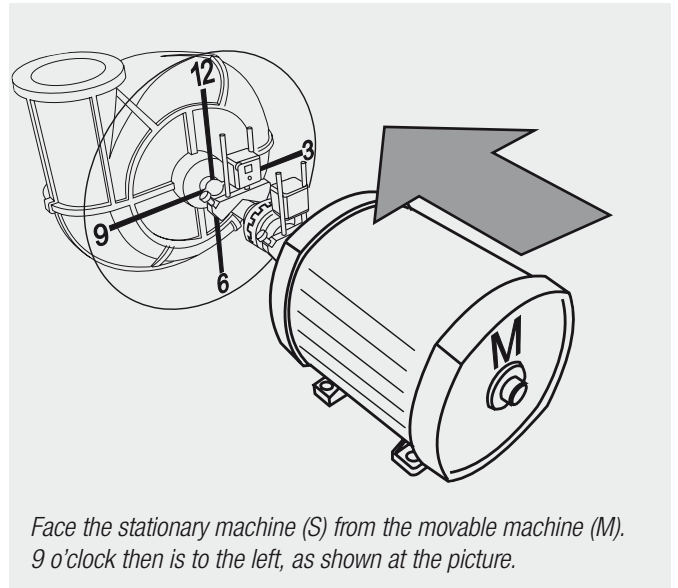

*Indicator for measurement direction, that in the **EasyTurn™** program shows the real position of the units. Note! In the **Horizontal program** the indicator shows how the units **have to be** positioned for true live values.

The foot symbols are filled for that direction (horizontal or vertical) in which the measurement values are updated live. Note! Be sure that the units are positioned in the right direction (3 alt. 9, or 12 alt. 6 o'clock).

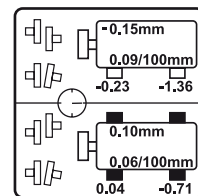

MEASUREMENT RESULT WITH TOLERANCE CHECK

The measurement result can be checked towards tolerance value table. This is based on the speed of the machine. When the alignment is within tolerance, the left part of the coupling symbol is filled. This also works live. The coupling symbols for horizontal and vertical offset and angle is filled independently of each other. This clearly displays which values are within tolerance, making it easy to adjust the others.

Note! There is a Speed Range "User". Here you can define your own setting. This setting will only remain during this measurement, and will be cleared if you start a new measurement, or turn the Display unit off.

Speed	0-1000	1000-2000	2000-3000	3000-4000	4000-	rpm
Offset	3.5	2.8	2.0	1.2	0.4	mils
	0.09	0.07	0.05	0.03	0.01	mm
Angular error	0.9	0.7	0.5	0.3	0.1	mils/inch
	0.09	0.07	0.05	0.03	0.01	mm/100mm

Tolerance table with maximum values for offset and angle, towards which the actual values are checked.

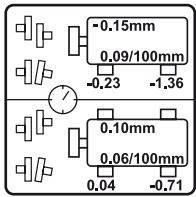

1. The result is displayed.
Press **[4]** to select tolerance checked displaying.

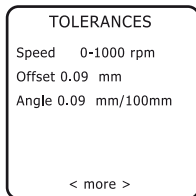
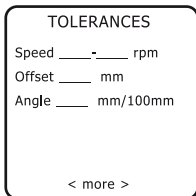

2. Select Speed range.
No tolerance values are displayed from the start (the function is disabled every time the measurement system is started).

Press or to select speed range. The tolerances is displayed at the same time.

Confirm Speed range

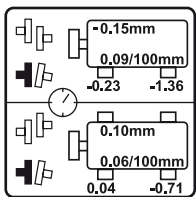

3. The result is displayed with filled coupling for values which are within tolerance.
(In the example above the angular values are within tolerance, but the offset is too large.)



MEASUREMENT RESULT WITH THERMAL GROWTH COMPENSATION

You enter specified values (from the manufacturer of the machines) for offset and angular deviation caused by thermal growth. The system compensates for these and recalculates the foot values to true adjustment values. This function works with programs Horizontal, EasyTurn™ and Machine Train. Read more about thermal growth at page D2.

Procedure for setting thermal growth values:

1. At the display, show the result for the coupling you want to set compensation value for.
2. First enter the direction for the Horizontal offset, then the value.
3. Horizontal angle; direction and value.
4. Vertical offset; direction and value.
5. Vertical angle; direction and value.
6. Go back to result display, now it is compensated for thermal growth.

Special notes for Machine Train Program:

NOTE1! When using the Machine Train Program, note that it is the machine "to the right" at each coupling you enter values for. Select coupling by pressing  and .

Go to the next coupling you want to set compensation values for and repeat steps 2–6 above.

NOTE2! Works both at graph and digital display.

NOTE3! You can also enter the values directly after the measurement of each coupling.

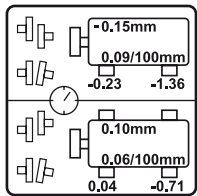

1. The result is displayed.

Press **[6]** to go to Thermal Growth Compensation.

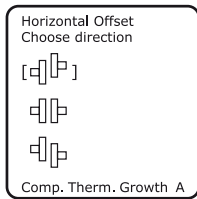

2. Enter the direction for the horizontal offset:

Change Offset direction with 

Confirm choice with 

[Back ]

Example:

Entering compensation values for coupling A.
(If you are working with Machine Train Program it will indicate B, C etc here.)

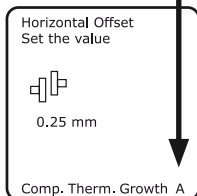

3. Enter the value for horizontal offset:

Type the value with the numerical buttons.

Confirm value with 

[Back ]

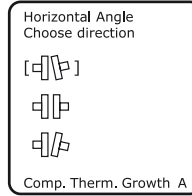

4. Enter the direction for horizontal angle:

Select Angle direction with 

Confirm choice with 

[Back to step 2 ]

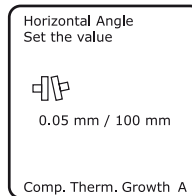

5. Enter value for horizontal angle:

Type the value with the number buttons.

Confirm value with 

[Back to step 2 ]

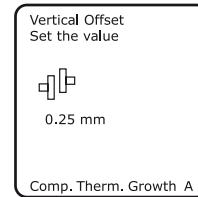
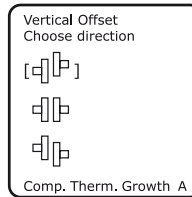

6. Enter the direction and value for vertical offset according to steps 2 and 3.

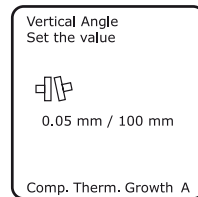
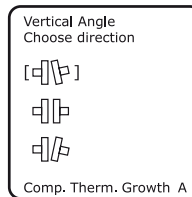

7. Enter direction and value for vertical angle according to steps 4 and 5.

8. The program returns to measurement value display, now with compensation for thermal growth. If wanted, go to the next coupling (display the result for the coupling) and enter compensation values for this according to steps 2–7. (The compensation values are shown at the print out.)

[At a compensated coupling, press **[6]** to change values. By confirming no value the compensation will be reset.]

CARDAN PROGRAM

The **Cardan program** is used when aligning offset mounted machines. The procedure is shown step-by-step. When there are threads at the end of the “movable” shaft, mount guiding pins on the turnable magnet bracket. The guiding pin centres the bracket and permits turning when indexing. Attach the measuring units to the fixtures using the central M6-threads.

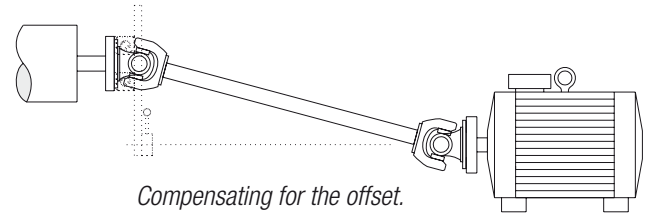
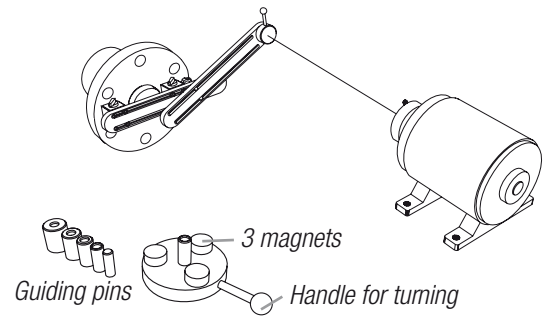

1. Mount the fixture arm with magnets on the shaft end of the stationary machine (if needed, use extension arm to compensate for the whole offset).

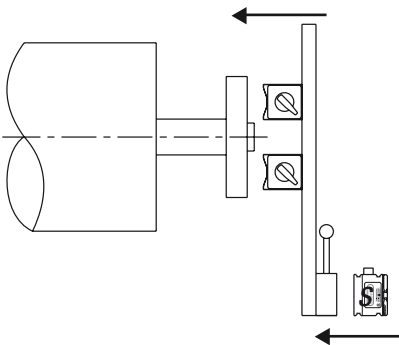

2. Mount the measuring unit S on the fixture arm.

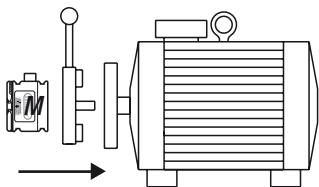

3. Mount the turnable magnet fixture on the end of the shaft of the movable machine. Mount the measuring unit M on the fixture.

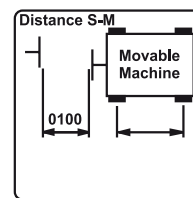

5. Measure and enter the distances.

Confirm each distance with

[Redo]

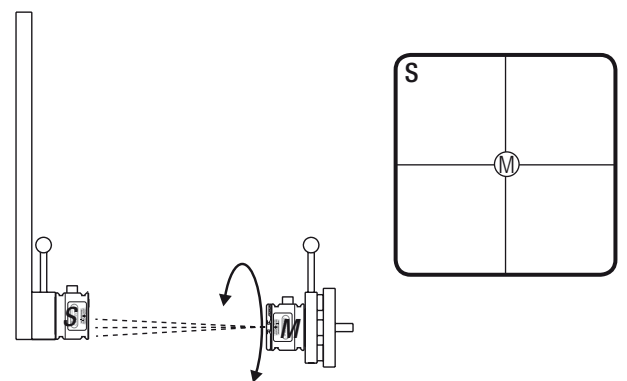
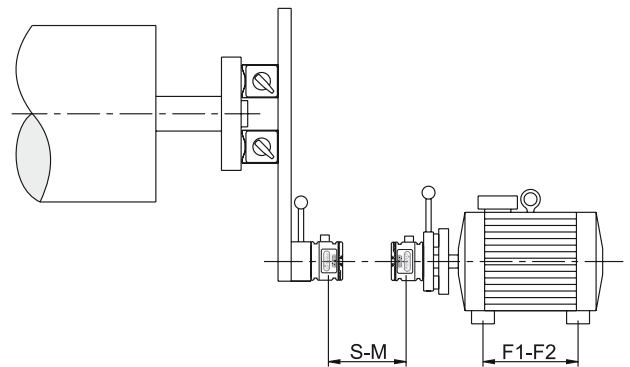

4. Connect the S and M unit to the display unit and start the Cardan program.

6. Press **[8]** for Target mode and , then adjust the M laser to the centre. Press **[8]** and use the hand on the display to turn the unit half a turn; the spot moves away from the centre. Now press **[8]** again and adjust the beam half way back.

CARDAN PROGRAM

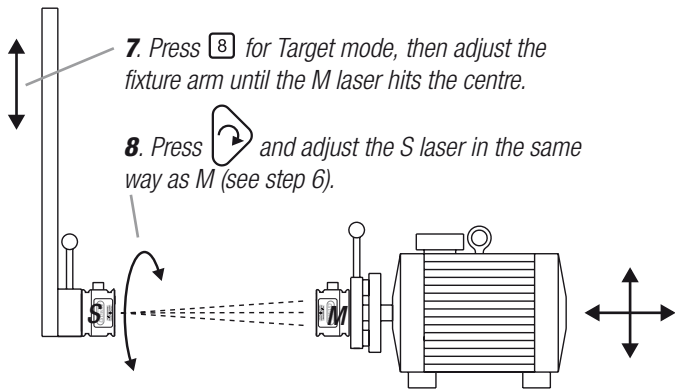

9. Roughly align the movable machine to both S and M centre. **NOTE!** Final adjustment of the fixture arm may be needed. Press [8] to exit Target mode.

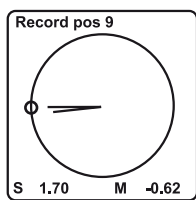

10. Face the stationary machine from the movable machine. Turn both measuring units to position 9. Aim the beam. Record the first value.

Confirm [Redo]

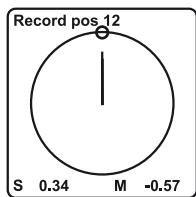

11. Record the second value in position 12. (Labels upwards.)

Confirm
[Redo]

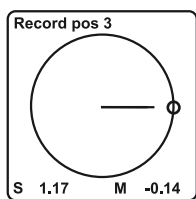

12. Record the third value in position 3. (Labels to the right.)

Confirm

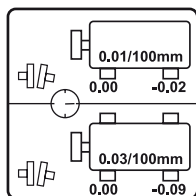

13. The result is displayed.

When parallel adjustment is not needed, only one end of the machine should be adjusted, therefore the other pair of feet is set to zero.

[Pressing [5] will toggle the LIVE display between the horizontal and vertical direction (Measuring units must be in position 3 or 12).]

[Press [9] to restart a measurement from position 9.]

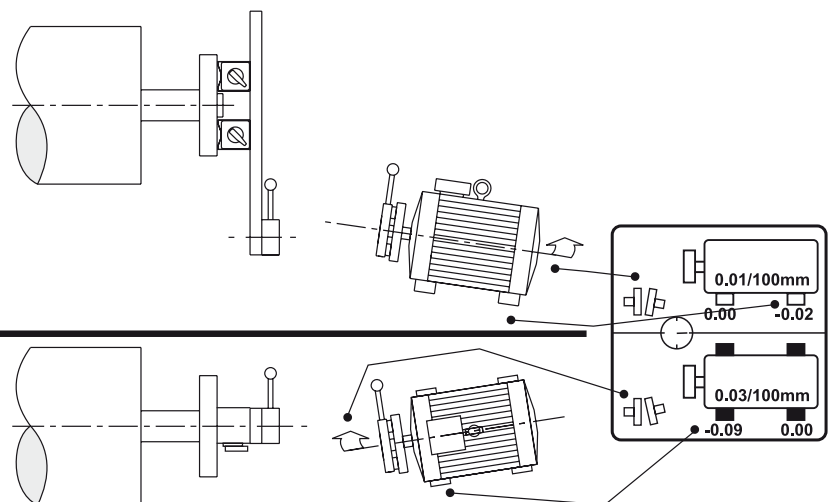

VERTICAL PROGRAM

The **Vertical program** is used for the measurement of vertical and flange mounted machines. Position the measuring units and record the values at positions 9, 12 and 3.

The 9 o'clock position is selected at any bolt. Rotate the measuring units a total of 180°.

Procedure: mount the measurement equipment, start the Vertical program, enter the distances, number of bolts and the diameter, start the measurement.

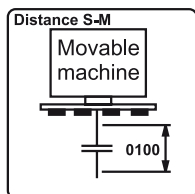

1. Enter the distances, as prompted by the system.

Confirm each distance

[Redo with]

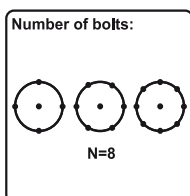

2. Enter the number of bolts.
(4, 6 or 8)

Confirm

[Back]

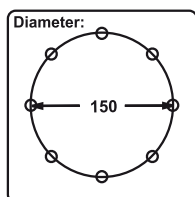

3. Enter the diameter between the bolts.

Confirm

[Back]

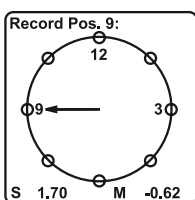

4. Place the units in position 9 (Bolt 1), aim the beam, record the value.

Confirm

[Back]

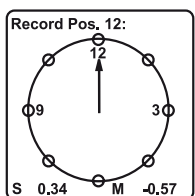

5. Place the units in position 12. Record the value.

Confirm

[Back]

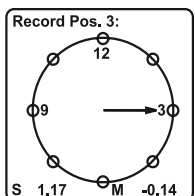

6. Place the units in position 3. Record the value.

Confirm

9-3 (3) LIVE
± 0.07
± 0.26 /100 mm
6-12 (12)
± 0.03
± 0.24 /100 mm

7. The result is displayed.

Offset and angular error in two directions (9-3 or 6-12) for the movable machine are shown both digitally and graphically. If the machine is adjusted, a new measurement is needed to get all the values updated.

Adjust sideways according to the offset value (continuously updated). The direction depends on the position of the measuring units; 3 or 12.

[Toggle LIVE with **5**]

[To enter new distances, press]

[Press **9** to restart measurement from position 9]

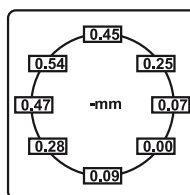

8. The shim values are shown by pressing . The "highest" bolt is displayed as 0.00.

Shim according to the shim values.

[Press **9** to restart measurement from position 9]

[Back to offset and angular error (step 7)]

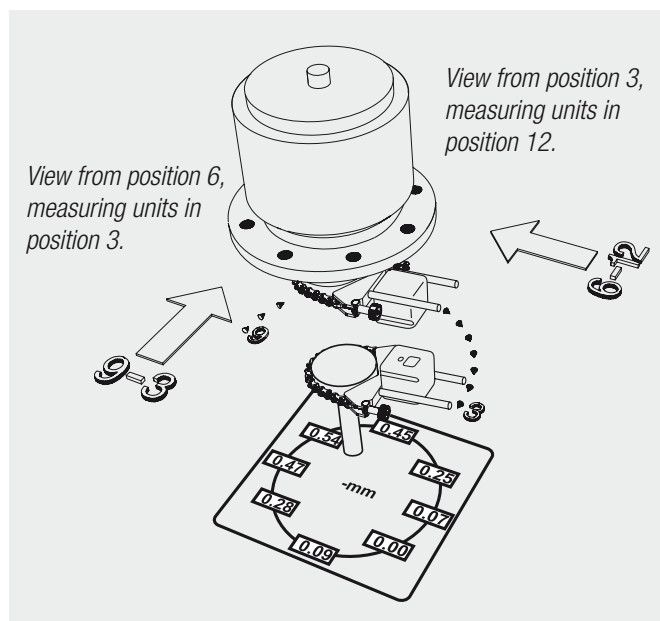

OFFSET AND ANGLE PROGRAM

The **Offset And Angle program** continuously displays measurement values from two measuring units S and M. The measurement values can be zeroed and any offset and angular changes between the units that may occur are displayed. You will get both horizontal and vertical values at the same time. The program is intended for dynamic measurements. Procedure: Mount the units, start the program.

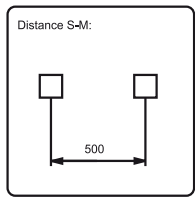
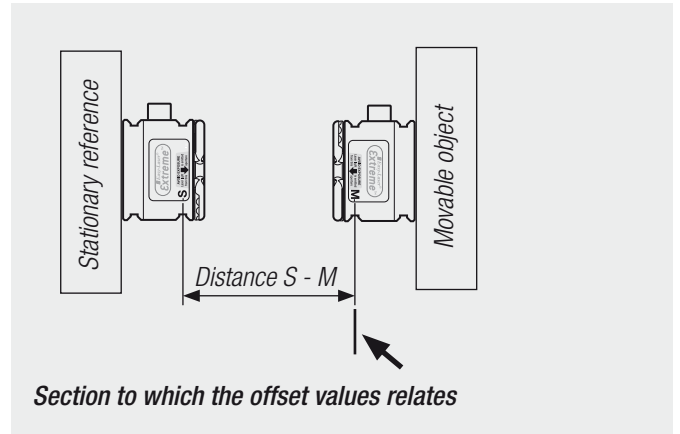

1. Enter the distance S - M.

Confirm

Aim the beams.

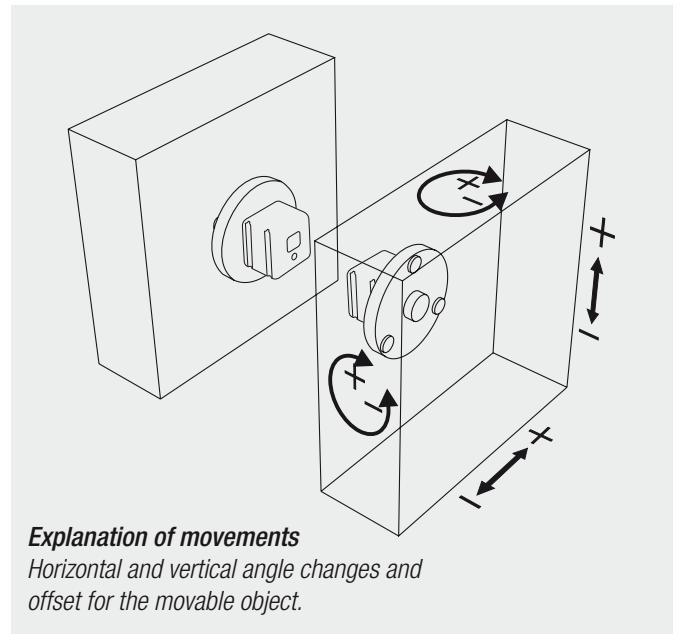

Explanation of movements

Horizontal and vertical angle changes and offset for the movable object.

S unit inclinometer value

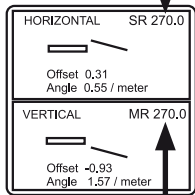

2. The measurement values are shown.

Zero the values by pressing

Absolute values

Halve the values

Send to serial port (continuously)

Target mode

M unit inclinometer value

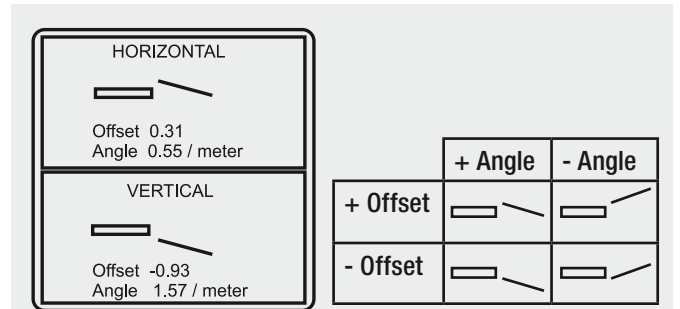
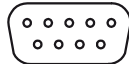

Example of measurement values

VALUES PROGRAM

The **Values program** continuously displays measurement values from the detector.

Procedure: mount the measurement equipment, start the Values program, aim the beam.

NOTE! The "Store" function cannot be used with this program.

Explanation of the measurement values (+, -)

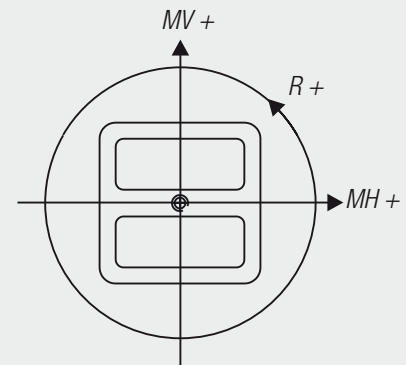

Measuring unit M (seen from behind)

Serial No. from displayed unit

Angle

S.no 39968 R 23.5

MV 0.35	MH 0.27
MV 0.15	MH 0.10
MV 0.23	MH -1.24
MV 5.18	MH 0.07

Registered measurement values (Max. 10 displayed)

M unit Horizontal

The number of connected units

Actual unit

M unit Vertical

Units 1 / 2

1. The measurement values are displayed immediately when starting the program.

Zero actual

Absolute values

Halve

Send to serial port (continuously)

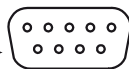

Large figures / small figures

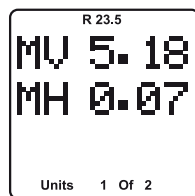

Last unit

Next unit

Record

Clear display

H-value on/off

All units displayed

Target mode

MACHINE TRAIN PROGRAM

With the Machine train program up to ten coupled or uncoupled machines in a row (nine couplings) can be measured. The EasyTurn™ function is used, which allows for a complete measurement with only 40° turn of the shafts. The display shows live values both digitally and graphically, which makes the alignment easy.

Feetlock

The program has Reflock function which means that any two pairs of feet in the machine train can be used as stationary reference, e.g. pair 1 and 10 or 3 and 4 (see fig.). The program is also suitable for measurement of two machines, e.g. a motor and a pump. You can choose which machine you want to use as stationary by changing references in the program.

Compensation for thermal growth

You enter specified values (from the manufacturer of the machines) for offset and angular deviation caused by thermal growth. The system compensates for these and recalculates the foot values to true adjustment values.

Note

During the measurement, the S-unit must always be mounted on the left machine (see fig.).

Explanation of signs

On the display these signs are displayed:

A, B, C,=the order and name of the couplings.

H=horizontally

V=vertically

S=stationary

M=movable

L=live

Ref.=reference

Ang.=angle

Off.=offset

1, 2, 3,=the order of the feet pair.

Measurement procedure (briefly)

1. Mount the measuring units at the first coupling (A).
2. Enter the distances according to the display.
3. Record the values at the first coupling.
4. Move the measuring units to the following couplings (B, C and D if four couplings are to be aligned), enter the distances and record the values.
5. If wanted, enter values for thermal growth compensation.
6. Enter which pair of feet that are to be references (by default the feet of the first machine, 1 and 2, are set to reference).
7. Document the measurement result.

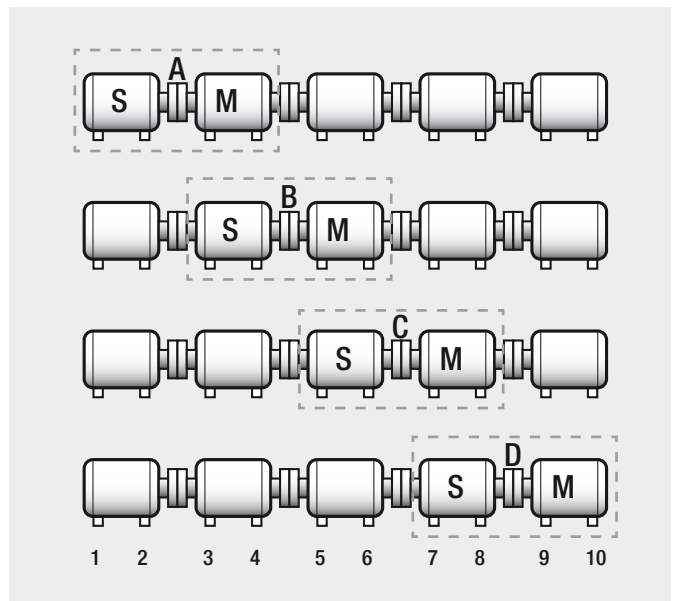
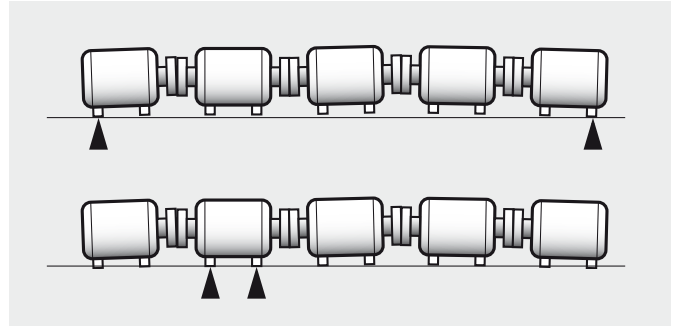

MACHINE TRAIN PROGRAM

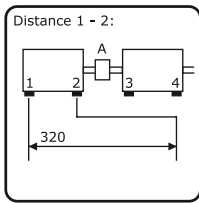

1. Enter the distances, as prompted by the program.

Confirm each distance with

[Back]

S and M measuring unit marker

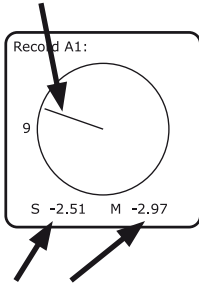

2. Place the measuring units so that the unit markers are on top of each other (or almost on top). Aim the beams. Record the first value.

Confirm value with

[Back]

S and M unit values

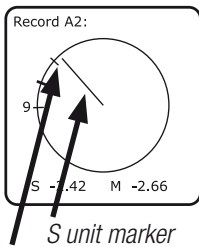

S unit marker
Angular mark

3. Second value. Turn shafts a minimum of 20° in any direction (shown as small angular marks at the circle). For uncoupled shafts; first turn the shaft with the S-unit, press **[8]**, then turn the shaft with the M-unit so that the S-laser hits the PSD. Press **[8]** again.

Confirm with

[Show/hide M-angular marker **[6]**]

[Redo first value]

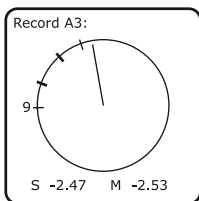

4. Third value. As second value. Turn units beyond 20° markings.

Confirm with

Ready A:		
	Hori.	Vert.
F 1 :	0.00	0.00
F 2 :	0.00	0.00
Ang.:	-0.41	0.02
Off.:	0.02	-0.03
F 3 :	-0.39	-0.02
F 4 :	-0.38	0.07
Ref. :	1	2

5. The result for coupling A is shown. Horizontal and vertical position, and angle and offset for the machines are displayed digitally. As default pair of feet 1 and 2 are set as stationary references.

Press to continue the measurement at coupling B.

(See step 11 for graph display.)

(See step 12 for reference setting.)

(See page C6 for thermal growth compensation.)

(See page "Measurement result" for adjustment of the machine.)

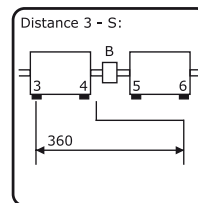

6. Enter the distances for coupling B, as prompted by the program.

Confirm each distance with

[Back]

(Note! The program already knows the distance 3-4.)

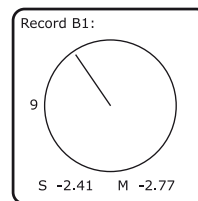

7. Place the units so that the markers are on top of each other (or almost on top). Aim the beams. Record the first value.

Confirm with

[Back]

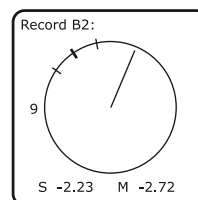

8. Second value.

Confirm with

[Redo first value]

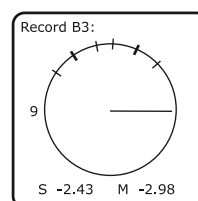

9. Third value. As second value. Turn units beyond 20° markings.

Confirm with



MACHINE TRAIN PROGRAM

Ready B:		
	Live	
	Hori.	Vert.
F 3 :	0.49	0.13
F 4 :	0.86	0.69
Ang.:	-0.31	0.04
Off.:	-0.04	-0.03
F 5 :	-0.41	-0.06
F 6 :	-0.36	-0.17
Ref. :	1	2

The result is displayed. Horizontal values are shown in "Live". This means that the measuring units are in position 9 or 3.

10. The result for coupling B is displayed. Horizontal and vertical position, and angle and offset for the machines are displayed digitally.

Press  to continue the measurement at coupling C (and after that D when the result for C is displayed), then follow the procedure according to steps 6–9.

[It says "LIVE" at either the horizontal or the vertical values when you turn the shafts with measuring units to positions according to 3, 6, 9 or 12 o'clock ($\pm 2^\circ$). Then the value updates continuously in each direction.]

[Change which coupling result is displayed by pressing

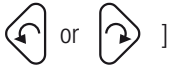

[Press **6** to set values for Thermal growth compensation. See page C6.]

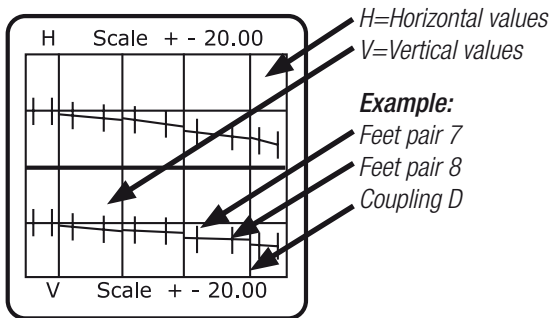

11. Graph display of the result: **4**

Toggle between graph/digital display of the values

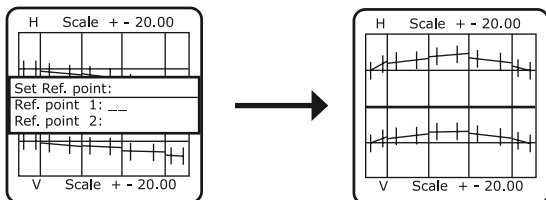

Window for reference setting.

Feet pair 1 and 10 as references.

12. Change references:

Press **0** to set new references. Enter the figures of the feet that are to be references. Confirm each with .

(NOTE! Works both at graph and digital display.)

STRAIGHTNESS PROGRAM

Straightness program. Use the S-unit as the Laser and the M-unit as the Detector. Attach the units on magnet bases. Prepare for the measurement by marking the desired measurement points. The program can handle up to 150 measurement points with two zero points. Use the target mode to aim the S-laser.

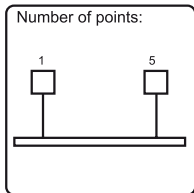

1. Enter the number of measurement points (2–150).

Confirm

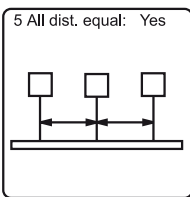
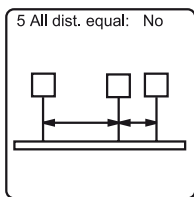

2. Are the points evenly placed on the object? Yes or No?

Toggle between No / Yes with

Confirm choice with

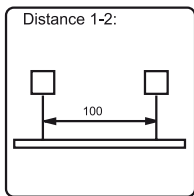

3. Enter the distances.
If evenly placed points, just enter this distance and confirm

If different distances, enter each distance and confirm each

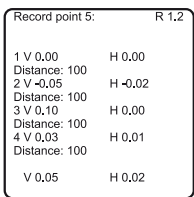

4. Place the Detector at point 1. Press and aim the beam to the center of the PSD, then exit Target mode.
Next, press and record the value.

[Zero value] (only at measurement point 1)

[Show absolute value] (only at measurement point 1)

[Halve the value] (only at measurement point 1)

[Show / Hide H-value with]

NOTE! If the H-value is not displayed when recording the last measurement value this cannot be displayed again.

[Back to Enter distance]

Next: move the detector to the following points and record the values.

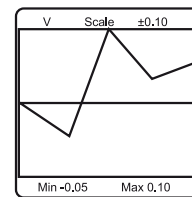
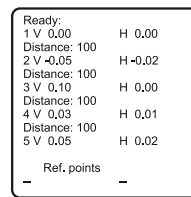
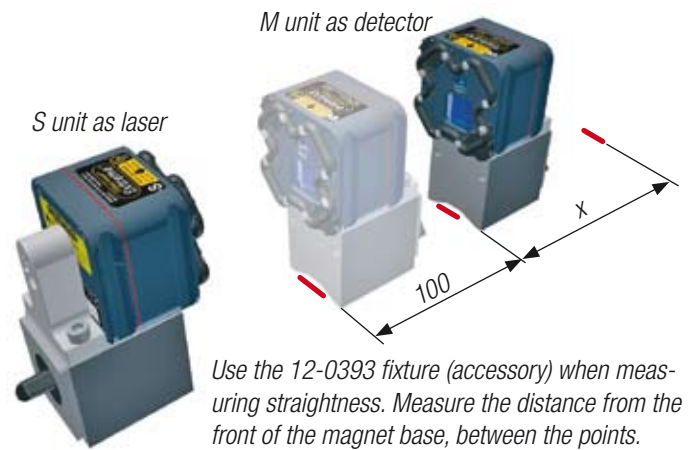

5. Ready. The result can be displayed as a graph or as a table. The graph can display vertical (V) or horizontal (H) measurement values. Measurement point 1 is at the left. The biggest deviation from zero sets the scale to one of three possible. The smallest and largest measurement values are displayed as Min. and Max.

[Back to registration of the last point]
(only possible before pressing another button).

[Shift to previous page]
(only possible after pressing another button).

[Shift to next page]

[Toggle between table and graph]

[Toggle V / H at graph display]

[New measurement from point 1]

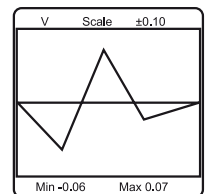
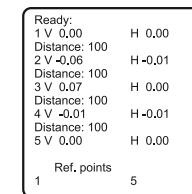
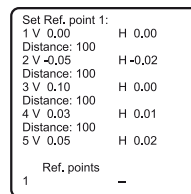

Selecting reference points.

Two of the measurement points can be selected as reference points, which will set them to zero. The values of the rest of the measurement points will then be recalculated. Selecting the same measurement point as ref.1 and ref.2 will give one zero point. New reference points can be set on a previously stored measurement.

[Select ref. points]

[Cancel all ref. points]

STRAIGHTNESS PLUS PROGRAM

The StraightnessPlus program differs from the standard Straightness program in that way that you can add and delete measurement points, or remeasure a previously recorded point anytime during the measurement. You can also set an offset value for the reference line, making the program calculate the correct offset adjustment values automatically. Other differences are that you always enter the distance measured from point 1 (the distance is what tells the program which point is which), and that you tell the distance when adding a point, not in advance.

As you do not have to tell the program how many points you are going to measure before starting the measurement it is not crucial to prepare for the measurement by marking the desired measurement points, but it is still a good idea to do so. The program can handle up to 150 measurement points with two zero points.

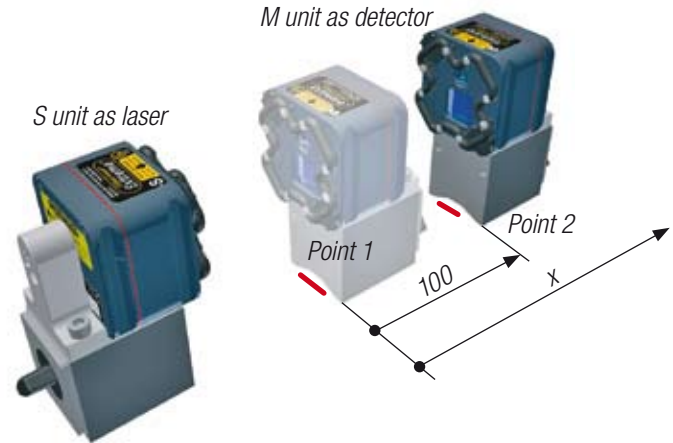

Use the 12-0393 fixture (accessory) when measuring straightness. Measure the distance from the front of the magnet base, always from point 1.

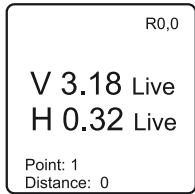

1. Detector values are displayed.
Current values calculated upon distances and reference settings. The measurement point number is calculated from the distances. Recording a new point will renumber higher points. Recording values at a previous recorded distance will erase the old values. Two points can at this moment be set to ref. points.

Record the values

[Set the point as a ref. point]
(after two references are set this is performed from the list display instead.)

[Show/hide the H value]

[Back to distances]

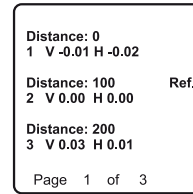

2. Measurement values are listed.
No live values. Recorded points, sorted by distance. Maximum five points at each page.

Add new point or remeasure

[Set ref. points]

[Cancel all ref. points]

[Set offset]

[Graphic display of the values]

[Return to Memory Menu (if restored)]

[Delete point from the list]

[Next list page]

[Previous list page]

(Perform additional steps only if wanted, or continue with step 3 above.)

STRAIGHTNESS PLUS PROGRAM

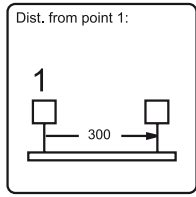

3. Add/edit measurement point.

Enter the distance from point 1 (the leftmost point).
 (Remeasuring or adjusting values for a previous recorded point is performed by entering the distance to that point. Recording will delete the old values for the point.)

Confirm entered distance

(After confirming a new point/distance the program jumps to step1, "Detector values are displayed".)

[Back to list]

Set Ref. points:

Ref. point 1: 1

Ref. point 2: 3

References

Shows the current reference points.
Set new or cancel a ref. point.

Set the entered point as a ref.

Entering number 0 will cancel a previously set ref. point.

Set Ref. points:

Ref. point 1: 5

Ref. point 2: 24

Offset

1. You always get the question to change/set Ref. points before setting Offset value. When/if OK, press

2. Next step is to enter values for Vertical and Horizontal offset for the Reference points.

Enter figure, then press

[Press before figure for negative value (-)]

V Scale ±0.05

Diagram

Graphical display of the values. Point 1 is to the left. The highest deviation from zero sets the scaling.

[Back to list]

[Toggle between V / H display]

Delete point:

Point: 3

Delete point

Enter the number for the point to delete. NOTE! The remaining points with higher number will be renumbered.

Delete the entered point

[Back to list (no deletion will be made)]

FACTS ABOUT LASER AND PSD DETECTOR

Light is a part of the electromagnetic spectrum, which also includes UV, IR, microwaves etc. Wavelengths between 400 nm and 780 nm are called visible light.

The word laser means: Light Amplification by Stimulated Emission of Radiation.

There are many applications for lasers and even more kinds of lasers to handle them. Instruments for length scale calibration (interferometers) of machine tools are most often equipped with gas lasers of helium-neon type. Within alignment instruments semiconductor lasers are the ones preferred. The benefits with this kind of lasers are the extremely compact design and very high directional stability of the beam.

To describe the laser principle we use a HeNe-laser because of its simplicity. The HeNe-laser consists of a glass tube with anode and cathode, filled with a mixture of helium and neon gas. At each end mirrors are placed, of which the one at the front is partially translucent. The tube is powered from a high-voltage supply unit. The light is then generated by the electrical discharge in the gas (spontaneous emission), and begins to “bounce” between the mirrors. Only light that is moving exactly parallel to the length axis of the tube can go on bouncing and get so powerful (stimulated emission) that it can pass through the translucent mirror as a laser beam. In principle laser light is similar to normal light, but consists of light with only one wavelength.

PSD is short for Position Sensitive Device. The PSD detector consists of a light-sensitive silicon wafer. For comparison the PSD can be called an analogue component, with theoretically unlimited resolution, on the contrary to a CCD detector (camera device), which is digital and with a resolution limited by the design. When the laserbeam hits the PSD, an electric current flows through the point hit by the beam. The electric currents at the two electrodes are proportional to the position of the beam. This makes it possible to determine the position of the beam center. The resolution possible is, quite literally, one in a million.

Easy-Laser® measurement systems uses a visible red laser beam as a measurement reference. The laser beam is directed to the PSD detector. Then the measurement programs in the Display unit calculate the values from the PSD and present the result according to which program is used.

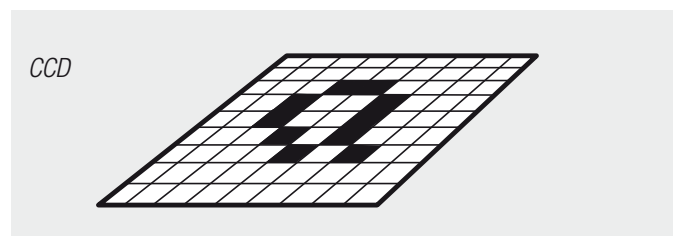
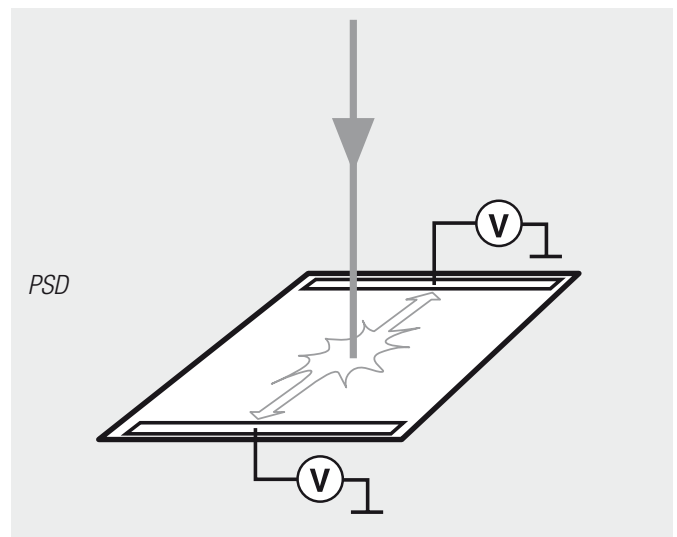
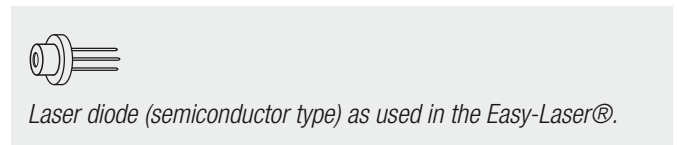
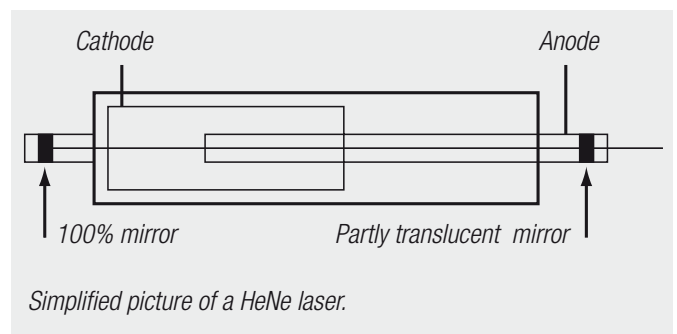
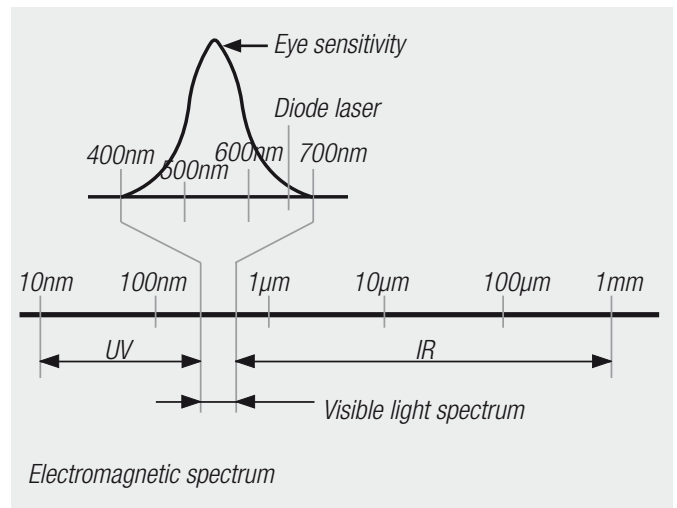

CONDITIONS FOR SHAFT ALIGNMENT

The conditions for a good alignment

Before you start the alignment you have to know how the machines will react in normal working conditions. To align machines that are in bad shape, or will move from their position just a short moment after starting them is a waste of effort.

New machines

Make a rough alignment, followed by a more accurate alignment when the installation is finished. Before alignment, check how the machine is working. Check the mounting bolts, coupling, vibrations, temperature, pipes and other connections.

Machine foundations (new installation)

Check that the foundations of both the machines are stable and flat, and that the concrete foundation has hardened before placing the machines. Observe that the feet of the machines should not rest directly on to the foundation, instead you should use shims. Clean the machine feet from dirt and rust. In addition the stationary machine should be shimmed a little bit higher than the moveable one before alignment.

To begin with, place approximately 2 mm of shims under each machine foot. Then you will be well prepared for the following alignment.

Dynamical movements

During operation, machinery will be influenced by different factors and forces. These factors may be thermal growth, twisting forces, aerodynamical forces and hydraulic forces to mention some. The sum of these factors will result in an offset deviation from the position of a "cold" machine. This new position of the shafts is normally called the "hot" condition. Depending on the kind of machinery, these changes can be of great importance.

Thermal growth

The result of the measurement can be influenced from different thermal growth factors for the S- and the M-machine. For example the thermal growth factor for steel is approximately 0.01 mm/m for each degree of temperature rising.

Example:

Height from foundation to shaft 1 m
Temperature when aligning +20 °C
Working temperature +50 °C
Thermal growth: $1 \times 0.01 \times (50-20)=0.3 \text{ mm}$

There is no problem when the S-machine has the same characteristics as the M-machine. In other cases you have to do the alignment before the machine get cold, or you have to compensate for the difference.

Example:

If the S-machine rises with 0.25 mm more than the M-machine as a result of the thermal growth, the shims under the M-machine also have to be increased with 0.25 mm (under all feet).

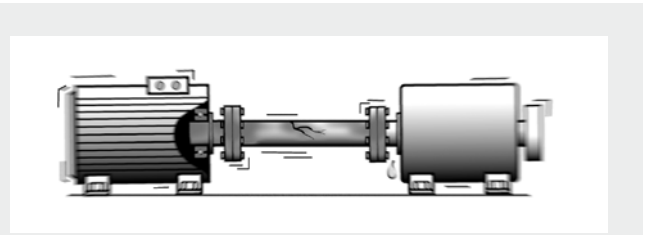

Misaligned shafts will always cause strains and stresses in bearings, shafts, couplings and the driving machine.

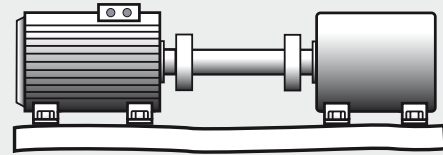

Reliable alignment is not possible if the machine foundation is not stable.

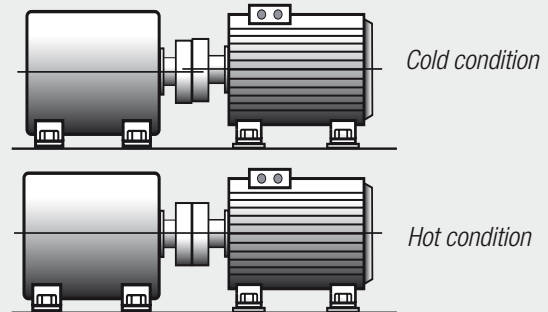

The machine manufacturers normally provide information about the thermal characteristics of their machines. Always check the following when deciding the influences of thermal growth:

The working temperature for both the machines.
The temperature coefficient for both the machines.
The influence of the surrounding temperature such as machinery insulation, external heat sources, cooling systems etc.

THERMAL GRADIENTS

You can easily see the effects of thermal gradients when the air is moving above the asphalt a hot summer day. It is then not possible to focus what is on the other side of this area. If the laserbeam passes through air with varying temperature, that may influence the direction of the laserbeam in the same way. During continuous measurement this could mean unstable readings. Try to reduce air movements between laser and detector by, for instance, moving heat sources, closing doors etc. If the readings remain unstable, you can use the measurement value filter feature in the Easy-Laser® systems.

Always ensure a good measurement environment.

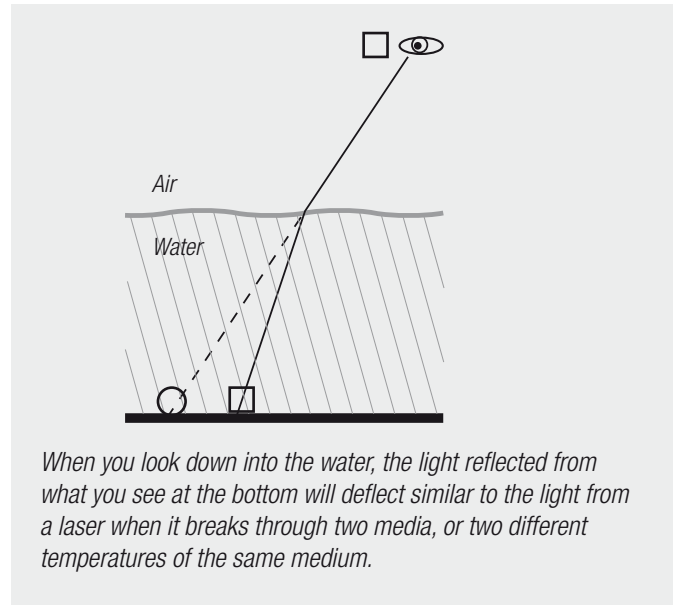
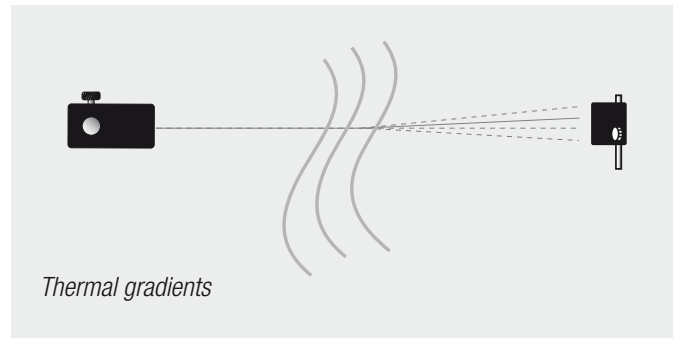

TECHNICAL TERMS

Technical terms within measurement and alignment that is important to know:

- Offset** *The centre lines of the two shafts are not concentric but parallel.*
- Angular deviation** *The centre lines of the two shafts are not parallel.*
- M-machine** *Movable machine. The machine that is adjusted relative to the stationary machine.*
- M-unit** *The measuring unit to be mounted on the movable machine.*
- S-machine** *Stationary machine. Must not be moved.*
- S-unit** *The measuring unit that shall be mounted on the stationary machine.*
- Softfoot** *A condition where the machine stands on three feet instead of four. This of course means that the machine is standing unstably on the foundation. Should be adjusted before alignment.*

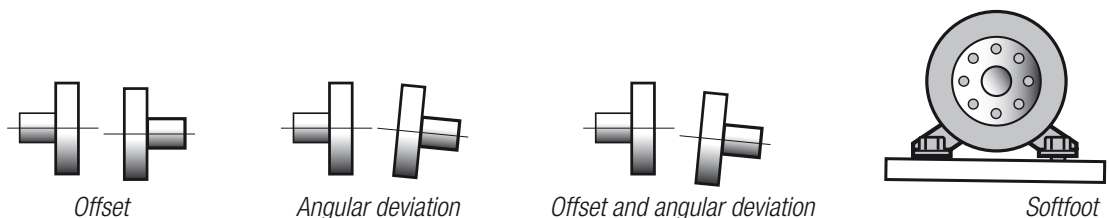

TOLERANCES FOR SHAFT ALIGNMENT

The rotation speed of the shafts will decide the demands on the alignment. The table on this side can be used as a guidance if no other tolerances is recommended by the manufacturer of the machines. The tolerances are set to the maximum allowed deviation from accurate values, with no consideration of whether that value should be zero or compensated for thermal growth.

Offset rpm	Excellent		Acceptable	
	mils	mm	mils	mm
0-1000	3.0	0.07	5.0	0.13
1000-2000	2.0	0.05	4.0	0.10
2000-3000	1.5	0.03	3.0	0.07
3000-4000	1.0	0.02	2.0	0.04
4000-5000	0.5	0.01	1.5	0.03
5000-6000	<0.5	<0.01	<1.5	<0.03
Angular error rpm	mils/inch	mm/100mm	mils/inch	mm/100mm
0-1000	0.6	0.06	1.0	0.10
1000-2000	0.5	0.05	0.8	0.08
2000-3000	0.4	0.04	0.7	0.07
3000-4000	0.3	0.03	0.6	0.06
4000-5000	0.2	0.02	0.5	0.05
5000-6000	0.1	0.01	0.4	0.04

CONVERSION TABLES

Angle					
arc sec.	mil/foot	mil/inch	mm/m	degree	inch/foot
1	0.06	0.005	0.005		
16.6	1	0.083	0.083		
	12	1	1	0.057°	0.012
	210	17.45	17.45	1°	0.21
	1000	83.3	83.3	4.75°	1

Example:

The diagram shows a horizontal line representing a shaft of length 1000 mm (1 meter). At the right end, there is a vertical arrow pointing downwards, labeled with a 1° angle. A vertical dimension line on the right indicates the offset distance of 17.45 mm.

Temperature	
°C	°F
-40	-40
-30	-22
-20	-4
-17.8	0
-10	14
0	32
10	50
20	68
30	86
37.8	100
40	104
50	122
60	140
70	158

Mass		
gram (g)	ounce (oz)	pound (lb)
1	0.035	
28.35	1	
453.59	16	1
1000		2.205

Length				
mil	mm	inch	foot	meter
0.0394	0.001			
0.05	0.00127			
0.3937	0.01			
0.5	0.0127			
1	0.0254	0.001		
3.937	0.1	0.0039		
5	0.127	0.005		
39.37	1	0.0394		
100	2.54	0.1		
1000	25.4	1	0.0833	
	304.8	12	1	0.3048
	1000	39.37	3.28	1

PROBLEM SOLVER / MAINTENANCE

A. The system will not start:

- 1 Don not let go of the On-button so quickly.
- 2 Check that the battery poles are facing the correct side according to the labels. Note! This must not be done in potentially explosive atmospheres.
- 3 Change batteries. Note! This must not be done in potentially explosive atmospheres.

B. The laser does not light up:

- 1 Check the connectors.
- 2 Change batteries. Note! This must not be done in potentially explosive atmospheres.

C. No measurement values are displayed:

- 1 See B
- 2 Aim the beams.
- 3 Adjust the laser to the detector.

D. Unstable measurement values:

- 1 Tighten the screws at the fixtures etc.
- 2 Adjust the laser away from the PSD edge.
- 3 Increase the filter setting.

E. Wrong measurement values?

- 1 Study arrows and signs on the detector labels.

Cleaning

For the best measurement result, always keep the equipment clean and the optics at the detector and laser very clean from dirt and fingerprints. Use a dry rag for cleaning.

Batteries

The system is powered by four Duracell Procell Alkaline Mn 1400 (PC1400) LR14 1.5 V batteries. Do only use this type of battery. If the system will not be used for a long time, the batteries must be taken out.

Note! This must not be done in potentially explosive atmospheres.

Avoid direct sunlight

If the measuring unit/detector has to be placed so that sunlight hits the PSD directly, there is a risk of unstable measurement values. Try to shade the detector.

EASYLINK™ PC SOFTWARE FOR WINDOWS®

EasyLink™ is a data transfer and database software for Windows. The export function supports the Excel, Works and Lotus programs.

The import function supports, besides Easy-Laser®, also measurement systems from some other manufacturers. Up to 16000 measurements per database can (at the time of publication of this manual) be handled/stored by the program.

For the best functionality the EasyLink™ program should be upgraded continuously. The latest version is always available for download at our web site: www.damalini.com

Because of this some of the functions in the program might differ from what is described on the following pages. When necessary, please check the internal Help files of the program.

Installing the program

1. Place the Easy-Laser® CD in the CD drive of your PC. The presentation program that also includes the installation files for EasyLink™ will normally autostart. Choose language. Then the image according to Fig. 1 will appear. Click on the image (at the arrow), then choose type of installation ("full installation" if this is the first time the program is installed).

If the CD doesn't start automatically, do like this: Under the [Start]-menu, choose [Run]. Then type the path "D:\fscommand\Install.exe". Press [OK]. (Note: "D" is just an example, type the letter of your CD drive here.)

2. The program will be installed with preset alternatives if you don't choose otherwise (Fig. 2). Press [Next] in the following dialogs until the program installation starts.

3. Press [Finish] to finish the installation.

4. Remove the CD from the CD drive.

When installation is complete the program icon appears at the desktop. You can also find the program in the [Start]-menu.



The first time you start EasyLink™ the program asks for registration data (Fig. 3). You should e-mail this to get information on program updatings.



Fig.1

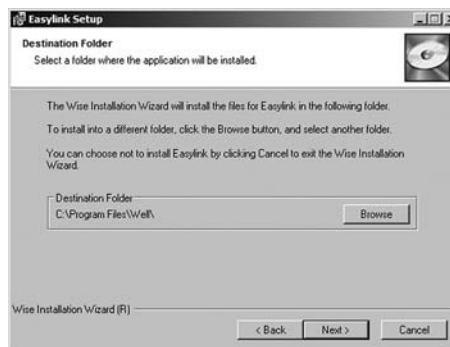

Fig.2



Fig.3

EasyLink™ requires; DOS:
Windows® 2000, XP, Vista, Win7.
RAM: 256 MB
Available hard disk space for program files: 50 MB.
Serial cable – nullmodem type (i.e. serial LapLink cable).

Update EasyLink™ via the internet

If you want to update an older version of EasyLink™ for Windows, do as follows :

1. Under "Help" in EasyLink™, choose "Update via internet"
2. The dialog in Fig. 4 will appear.
3. Press "OK" and your internet browser starts* and locates the address assigned in the dialog.
4. In the next dialog, choose "Save to disc"
5. Download the file to C:\Program\Well (which is the EasyLink™ folder)
6. Under the "Start" menu, choose "Run" and browse for the file (C:\Program\Well \Update.EXE) where x is the update version)

*Some browsers doesn't support this function. Then you have to download the file manually from www.damalini.com instead.



Fig.4

Communication setup

Start the EasyLink™ program.

Under "Settings", choose the Com-port to which the serial cable is connected. Only available ports can be selected. Note that a port that appear to be available sometimes can be assigned to camera or phone programs in your PC, which makes it necessary to reconfigure these.

Transferring data from the Display unit.



Connect the Display unit to the PC with the serial cable that came with the measurement system.

Note! This must not be done in potentially explosive hazardous areas!

In the Display unit, display the measurement you want to transfer to EasyLink™ by pressing ,

then  (restore), then choose your measurement file.

In the *Memory option* menu, press  to view the file.

Press the menu button  again, and then  to transfer the data to the PC.

When the transfer is finished the current measurement will appear in the data window in the EasyLink™ program.

Note that it is only from the Start page of EasyLink™ communication with the Display unit can be established. The program automatically assigns a suitable picture, but you can change this picture later to one of your own.

A serial cable for EasyLink™ can usually be bought from any computer store. The cable is a "null modem" cable (also known as Laplink). The connections of the cable must be configured as in the picture to the right.

Note!
The length of the cable should not exceed 3 meters.

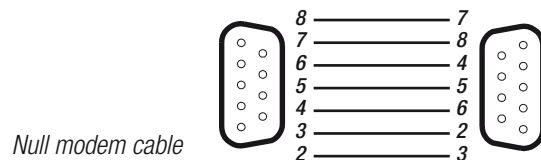

Null modem cable

Important! When transferring data to a PC, be sure that there are no reference points set (Program Straightness), otherwise the EasyLink™ program cannot calculate absolute values.

EASYLINK™ PC SOFTWARE FOR WINDOWS®

When you start the EasyLink™-program the start window appears with all saved measurements listed to the right. You can sort these by type of measurement, date, time or file name by clicking at the buttons right above the list.

Open a saved measurement by double clicking on it in the list.

To right-click at a measurement in the list gives you more options (see below).

Open database Choose alternative database
 Export to spreadsheet..... Export to spreadsheet
 Print report (only in measurement window)
 Print value list..... Prints measurement values and measurement information
 Print picture..... (only in measurement window)
 Download from other instrument.... Download measurement data from instrument other than Easy-Laser®
 Exit Exit Program

Copy picture (only in measurement window)
 Copy value list (only in measurement window)

Options..... (see below)

Help
 Update via internet
 Send Email for support
 EasyLink registration
 About

In the Options dialog you can make settings suitable for you.

The measurement data is displayed

graphically and digitally in the measurement window.

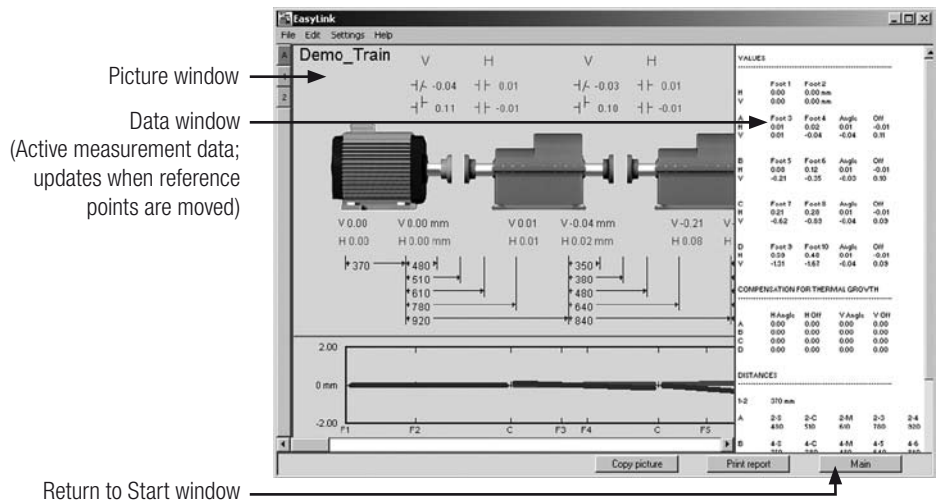

Copy the measurement data to other programs

In the Data window to the right the current data is shown. This data can be copied, and then pasted in to another document, e.g. Word or Excel documents.

Do like this:

1. Under "Edit", choose "Copy value list"
2. Open your document
3. Paste the data in [Ctrl+V]

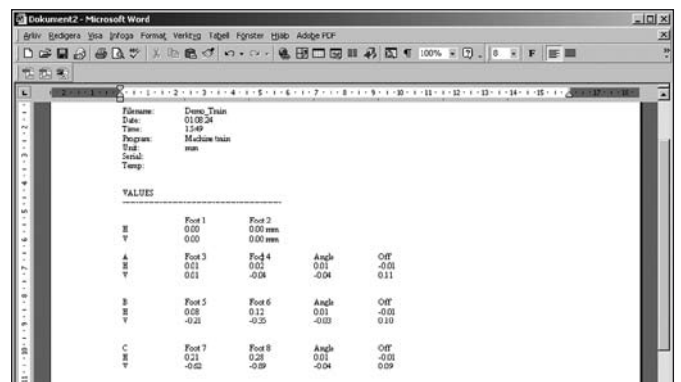

Copy the picture window to other programs

"Copy Picture" copies the picture in the Picture window, which you then can paste in to another document.

Do like this:

1. Press  , or under "Edit", choose "Copy picture"
2. Open your document
3. Paste the picture in [Ctrl+V]

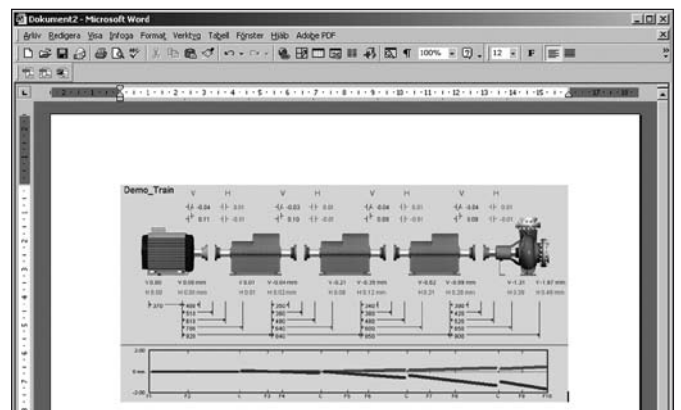

Print the data window

You can make a direct printout of the measurement data on your printer.

Do this:

1. Under "File", choose "Print report", or press 
2. Printout is done on your default printer.

Print the picture window



Do this:

1. Under "File", choose "Print picture"
2. Printout is done on your default printer.

EASYLINK™ PC SOFTWARE FOR WINDOWS®

Copy the screen of the Display unit directly to the EasyLink™ program

Do this:

1. Connect the Display unit to the PC.
2. Start the EasyLink™ program.
3. Show the display you want to copy from the Display unit.
4. Press  to go to the Main menu.
5. Press  and the display is directly copied into the EasyLink™ program, and opened in a new window.

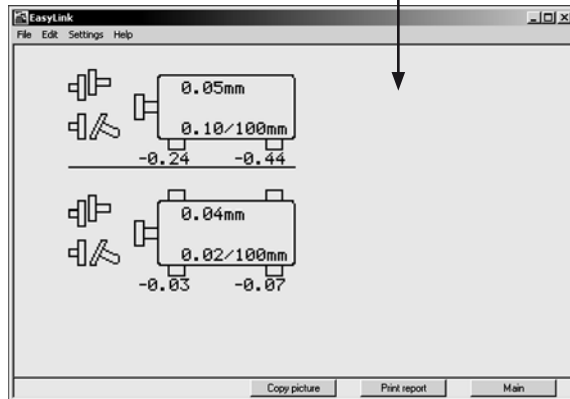

Exporting measurement data to spreadsheet

When exporting to MS Excel, do this (the Excel program must be installed on your computer):

1. In the Start window, first left-click once on the measurement, then right-click it to see the pop-up menu.
2. Choose "Export to spreadsheet" in the pop-up menu.
3. Excel automatically starts and the data is exported to a new spreadsheet.

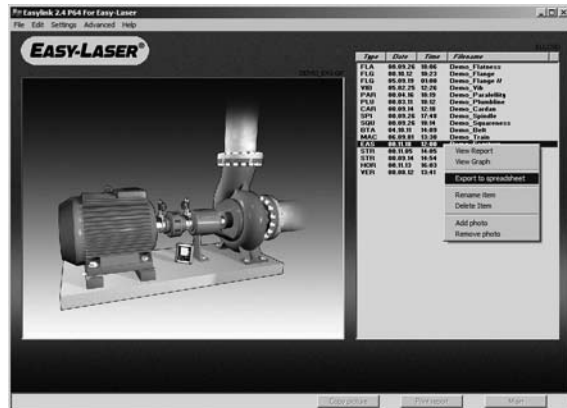

	A	B	C	D	E
1	Easylink 2.0 P27				
2					
3	Filename:	Demo Horizontal			
4	Date:	97.11.13			
5	Time:	16.03			
6	Program:	Horizontal			
7	Unit:	mm (mm/100mm)			
8					
9	S-M:	105			
10	S-Center:	53			
11	S-Foot1:	165			
12	S-Foot2:	285			
13					
14	V/H	Offset	Angle	Foot1	Foot2
15					
16	H	-2,43	0,28	-2,11	-1,77
17	V	0,12	-0,07	0,03	-0,06
18					
19					
20					
21					