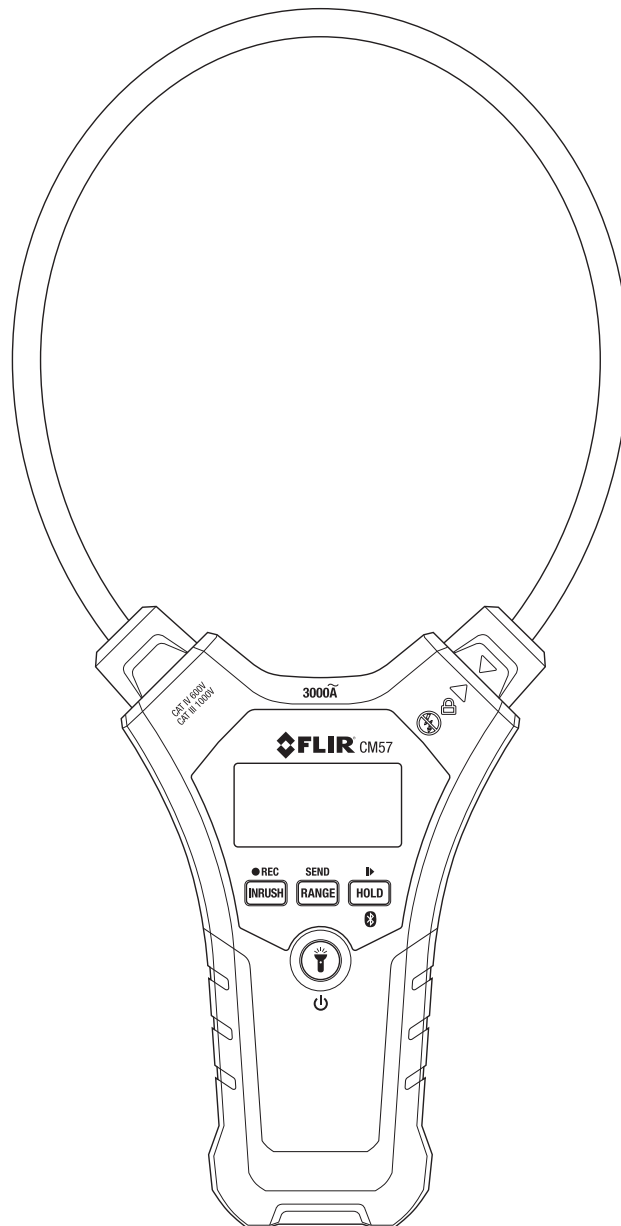

---

**FLIR MODEL CM55 and MODEL CM57****FLEX CLAMP METERS with Bluetooth<sup>®</sup>**

**USER GUIDE LOCATION:** The detailed User Guide is located in the product packaging and on the support.flir.com web site (download tab). Please read the entire User Guide to gain a thorough understanding of the meter before use.

Register for Extended Warranty and Product Updates at [www.flir.com/testwarranty](http://www.flir.com/testwarranty)

## Quick Overview

- Press and hold to power ON or OFF. Install or replace batteries in rear compartment if meter does not power up.
- Meter switches OFF automatically after 10 mins of inactivity.
- Current Measurements are covered on the next page.
- For the descriptive diagram at right, see the descriptions below:
  1. Work Lights
  2. Flexible Current Clamp Coil
  3. Display
  4. INRUSH / REC (Record) button
  5. Power / Work Light button
  6. RANGE / SEND button
  7. HOLD / Start-Stop Record / Bluetooth® button
  8. Clamp Lock mechanism

Note: Battery compartment on rear of meter



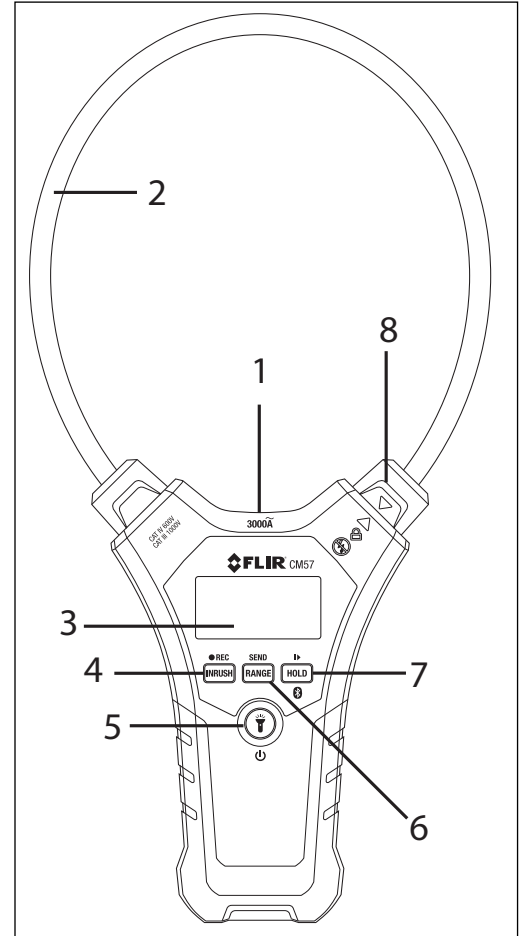





- When powered, press to turn Work Lights ON or OFF.
- Press HOLD to freeze displayed readings.
- Press RANGE for Manual Ranging (Auto Range is default).
- Press INRUSH for inrush current mode (refer to User Guide).
- Press and hold REC to record readings at 1 min. intervals.
- Press to Start/Stop recording (in REC mode only).
- Press and hold to activate Bluetooth® (real time readings will now be available to Bluetooth® paired devices).
- Press and hold SEND to transmit bulk stored readings via Bluetooth® (refer to User Guide for in-depth information).



## Button Overview

	<ul style="list-style-type: none"> <li>• Momentary press to access INRUSH mode</li> <li>• Press and hold to access the Record Memory mode (REC)</li> </ul>
	<ul style="list-style-type: none"> <li>• Momentary presses step through the ranges manually</li> <li>• Press and hold while in manual range mode to return to Auto range</li> <li>• Press and hold to Send data via Bluetooth® (refer to User Guide for in-depth information)</li> </ul>
	<ul style="list-style-type: none"> <li>• Momentary press to access the Data Hold mode</li> <li>• Press and hold to activate/deactivate Bluetooth® communication</li> <li>• While in Record mode, momentary press to Pause/Resume recording</li> </ul>
	<ul style="list-style-type: none"> <li>• Press and hold to switch power ON/OFF</li> <li>• When powered, press to activate/deactivate work lights</li> </ul>

## Display Icons

	Bluetooth® Communication		Display Hold		Amperes (Current)
	Battery status		Inrush Current		Auto Power Off (APO)
	Bulk Data Transmission		Memory (Recording) Mode		Auto Range mode

## AC Current Measurements

**⚠ WARNING:** Ensure that power to the device under test is OFF before starting this procedure. Switch power to the device under test ON only after the clamp has been safely attached to the device under test.

**⚠ CAUTION:** Do not move fingers above the LCD at any time during a test.

1. Switch the meter OFF and switch power to the device under test OFF.
2. Turn the clamp lock (1) counter-clockwise to release the flexible clamp (2).
3. Fully enclose only one conductor of the device under test with the flexible clamp probe (see diagram below for Correct and Incorrect usage).
4. Re-secure the clamp lock (1) after clamping around a single conductor.
5. Do not attempt to measure current higher than the specified current limit.
6. Switch the meter ON and then switch power to the device under test ON. Never move fingers above the display area when running a test.
7. Read the current value in the display; '**OL**' will display if the measured signal exceeds the range. The meter defaults to the Auto Range mode; the Auto Range icon  is visible on the display. The meter will automatically select the appropriate range when in Auto Range mode.
8. To manually select the range, use the **RANGE** button to step through the available ranges (30.00A / 300.0A / 3000A).

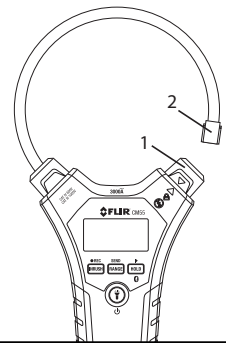

Unlock/Lock Clamp Jaw

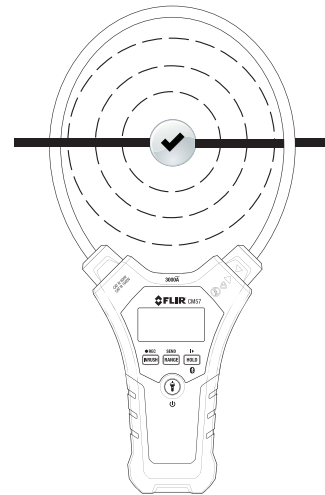
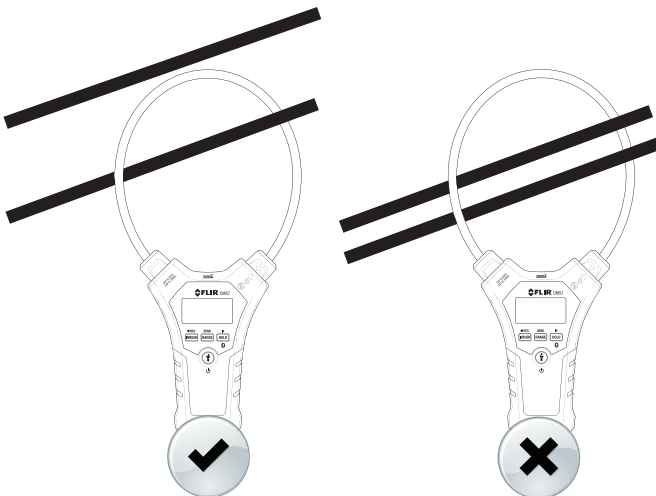

Positioning Conductor in Center of Clamp Jaw

Copyright © 2015 FLIR Systems, Inc.

All rights reserved including the right of reproduction in whole or in part in any form.

[www.flir.com](http://www.flir.com)



## Corporate Headquarters

FLIR Systems, Inc.  
2770 SW Parkway Avenue  
Wilsonville, OR 97070  
USA  
Telephone: +1 503-498-3547

## Customer Support

Technical Support Website	<a href="http://support.flir.com">http://support.flir.com</a>
Technical Support Email	<a href="mailto:TMSupport@flir.com">TMSupport@flir.com</a>
Service and Repair Email	<a href="mailto:Repair@flir.com">Repair@flir.com</a>
Customer Support Telephone	+1 855-499-3662 (toll free)

## Certificate of Conformity and ISO-9001 Quality Management System

FLIR Commercial Systems, Inc., an ISO 9001:2008 certified company, hereby certify that our instruments meet or exceed the specifications stated in the user manuals.

This instrument was produced under the stringent guidelines of FLIR Commercial System's certified ISO-9001 Quality Management System from design to delivery. All instruments are calibrated and inspected to meet the stated specifications.

FLIR Commercial Systems, Inc. inspects its incoming shipments using an approved sampling plan with an Acceptable Quality Level (AQL). All incoming inspections are performed using test equipment that is traceable to National Standards. Our ISO-9001 Quality Management System extends to aftermarket support where tested quality procedures are applied to customer support, service, calibration and repair processes.

This instrument will provide years of reliable service when used in accordance with the instructions provided in the User Guide. To have this device certified please contact your local service center.

### Quality Assurance Management



Publication Identification No.:	CM55_CM57-QS-mul
Release version:	AB
Release Date:	2015 June
Language:	Multiple