

FLIR MR176

Imaging Moisture Meter Plus IGM™

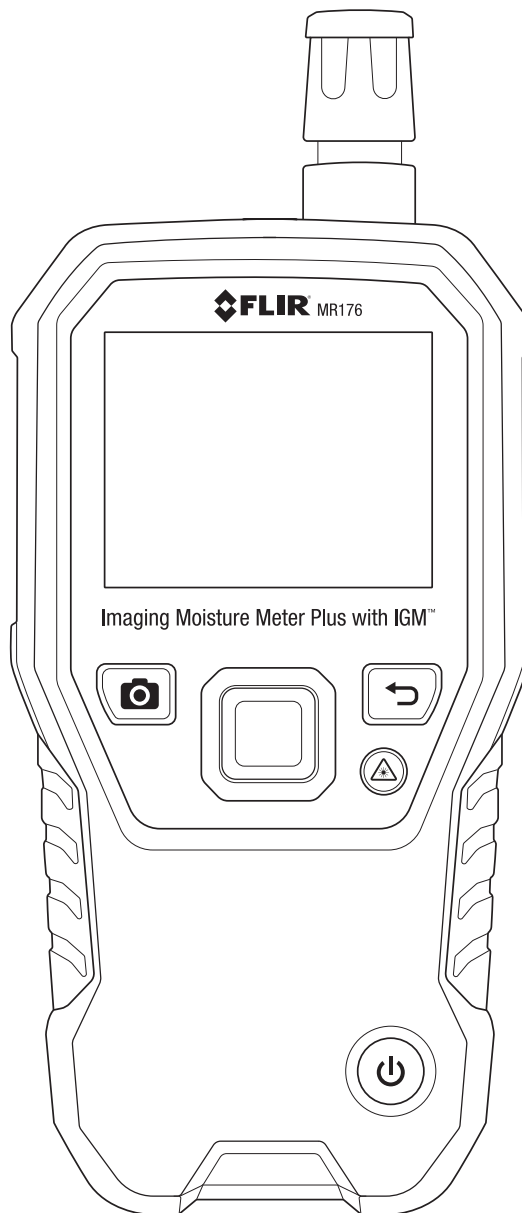

USER GUIDE LOCATION: Please read the detailed User Guide, located in the MR176 internal memory, for complete details on all MR176 features and functions. Connect the meter to a PC using the supplied USB cable and open the folder entitled 'DOC' to access the User Guide. The User Guide is also available on the website www.flir.com.

Register for Extended Warranty and Product Updates at www.flir.com/testwarranty

Quick Steps

- Charge the battery by connecting the supplied USB cable to a PC before first use.
- Press  to power ON (press and hold to power OFF).
- The MR176 first powers up in the IGM Custom mode. Use the Main Menu to change modes (press Select for the Main Menu).
- View IR Thermal Image, Moisture, Air Temperature, Relative Humidity (RH %), Dew Point, and Mixing Ratio on the display.
- Press the Laser button to activate the laser and display crosshairs.
- Place the internal pinless moisture sensor against a test surface (apply light pressure) to take relative moisture measurements.
- Press the image capture button to freeze the view and store a screen-shot. Press image capture again to confirm, or back to cancel. Use Image Review mode (from Main Menu) to view/delete stored images. Transfer images to PC using supplied USB cable.
- Refer to the informative User Guide for detailed instructions on External Probe use, Material Groups, Relative (Set Reference) mode, High Alarm, Psychrometrics, and more.
- For Fig. 1 at right, see the descriptions below:
 1. Temperature and Relative Humidity Sensor (MR01)
 2. Color Graphical Display
 3. Screen Capture button: Press to hold/record/store IR images
 4. Navigation buttons (ring) for up/down-left/right scrolling
 5. Select button (center): Press for Main Menu
 6. Back button: Press to return from a menu screen
 7. Laser Pointer and Crosshairs button
 8. Power button: Short press ON, long press OFF.
 9. USB, External Probe jack, and Battery charging LED
 10. Laser pointer lens (back)
 11. Thermal imaging lens (back)
 12. Internal Pinless Moisture sensor (back)
 13. Micro USB Port (bottom)
 14. External Probe Jack (bottom)
 15. Battery Charging LED status lamp (bottom)

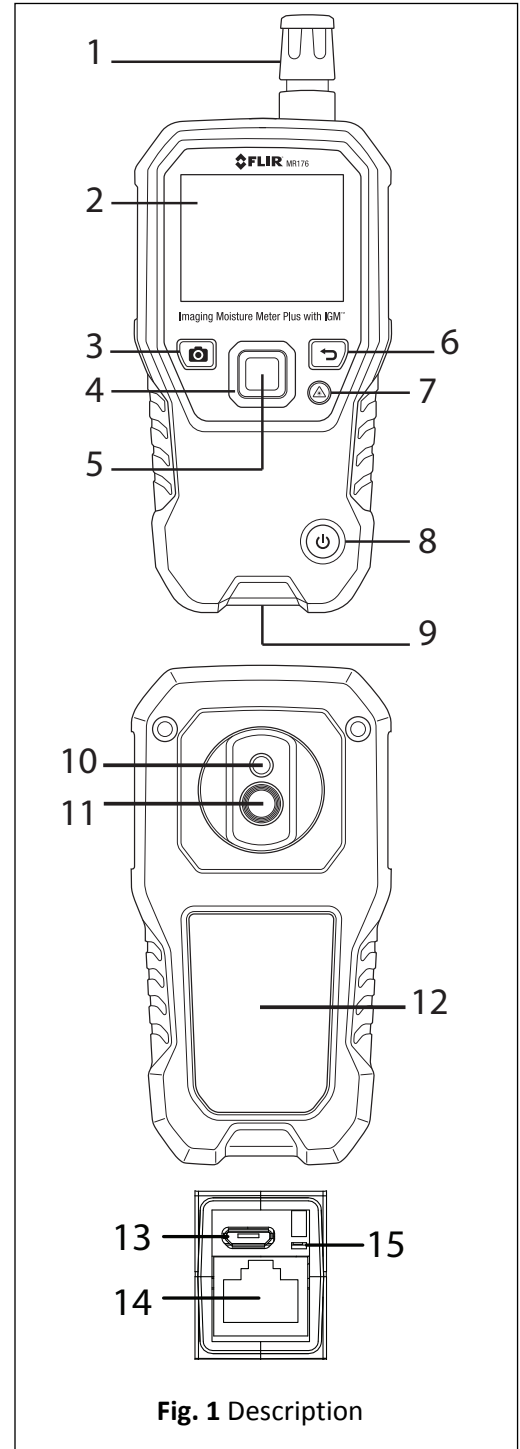



Fig. 1 Description

MAIN Menu

Press the Select button to access the Main Menu (Fig. 2) and to select icons. Use the four navigation buttons to move left-right-up-down. Use the Back button  to move out of a menu.

1. Image Review mode (view and deleted stored display images)
2. Image mode selection
3. Moisture mode selection and options
4. Lock/Unlock Palette auto-scaling
5. Settings menu

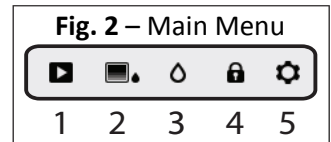
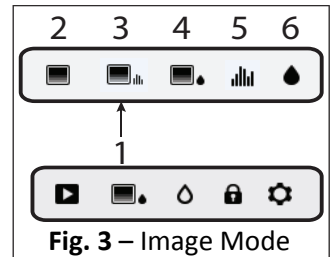

IMAGE Mode Selection

Press Select to access the Main Menu and then select the IMAGE mode icon (1). See Fig. 3.

1. Image mode icon from the Main Menu
2. IR Thermal Image mode only
3. IGM Custom mode: IR Thermal image and a custom set of parameters (Moisture, Air Temperature, RH%, Dew Point, Mixing Ratio, and Vapor Pressure); configurable in the Settings menu.
4. IGM Moisture mode (IR Thermal image and Moisture reading)
5. Psychrometrics screen. Displays Air Temperature, RH%, Dew Point, Mixing Ratio, & Vapor Pressure
6. Moisture reading with bargraph







MOISTURE Mode Selection

Press Select for the Main Menu and select the MOISTURE mode icon (1). See Fig. 4.

1. Moisture Mode Icon from the Main Menu
2. MATERIAL GROUP: Select a material wood group (pin mode); see User Guide for group tables.
3. PIN MODE: For external pin-based probe use
4. PINLESS MODE: For internal sensor use
5. SET REFERENCE: Compare displayed readings to a stored reference (pinless mode only)

Settings Menu

Access Settings by pressing the Select button and selecting the Settings mode icon .

1. **LANGUAGE:** From the Settings menu, scroll to **Language** and press Select. Use the Navigation buttons to scroll to the desired language and then press the Select button. The selected language will show a blue dot to its right.
2. **CONFIGURE IGM CUSTOM:** Choose the parameters to display in the IGM Custom Moisture screen (see Image Mode selection section above).
3. **PALETTE:** Select the color scheme (Iron, Rainbow, Ice, Grey) for IR Thermal image viewing by pressing the Select button.
4. **ALARM:** Scroll to **Alarm** and press Select. Use the up/down buttons to turn the alarm ON/OFF. Use the left/right buttons to select a threshold digit and then use the up/down buttons to change its value. Press Select to save and return.
5. **AUTO POWER OFF:** Scroll to **Auto Power OFF** and then use the Select button to step through the options (1, 5, 20 minutes, or OFF). Navigate to another SETTINGS option or press the back button  to exit the Settings mode.
6. **UNITS:** Select the desired temperature units ($^{\circ}\text{C}$ $^{\circ}\text{F}$ and GPP g/kg) using the Select button.
7. **DATE & TIME:** From the SETTINGS menu, scroll to **Date & Time** and press Select. Use the Navigation and Select buttons to program the Year, Month, Day, Hour, & Minute. Press Select to save and return to the SETTINGS Menu or press the Back button  to cancel.
8. **HELP SCREEN:** View technical support and training contact information.
9. **METER INFORMATION:** Scroll to **Meter Information** and press Select to view the Model, Software Version, and Last Calibration Date. Press the back button  to return to the SETTINGS menu.

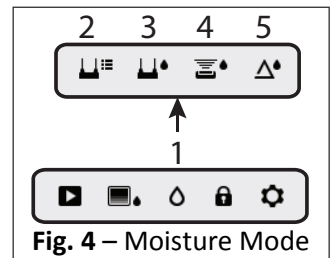

Basic Display Descriptions (Refer to Fig. 5)

IGM Moisture Mode Fig 5(a)

1. Thermal Image
2. Set Relative icon and reference value
3. Alarm icon and Alarm Threshold value
4. Moisture Mode icon (Pinless mode shown)
5. Moisture reading
6. Laser pointer icon
7. Cross-hairs

IGM Custom Mode Fig 5(b)

1. Thermal image
2. Mixing ratio
3. Dew Point temperature
4. RH% (solid green dot & green reading when stabilized)
5. Air Temperature reading
6. Moisture mode icon (Pinless mode shown)
7. Moisture reading
8. Alarm icon
9. Set Reference mode icon

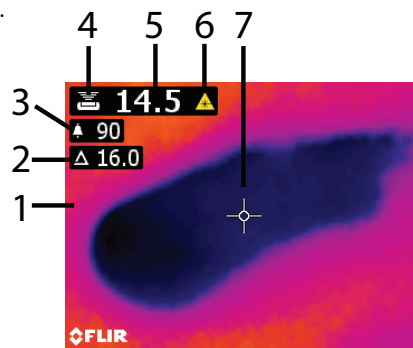

Fig. 5 (a) IGM Moisture mode

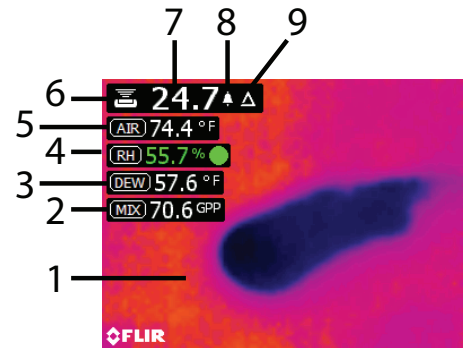

Fig. 5 (b) IGM Custom mode

Copyright © 2015 FLIR Systems, Inc.

All rights reserved including the right of reproduction in whole or in part in any form.

www.flir.com



USA – NASHUA

Support Site

FLIR Commercial Systems, Inc.
9 Townsend West
Nashua, NH 03063 USA
Telephone +1 855-499-3662

Customer Support

Technical Support Website <http://support.flir.com>
Technical Support Email TMSupport@flir.com
Service and Repair Email Repair@flir.com
Customer Support Telephone +1 855-499-3662 option 3 (toll free)

USA – PORTLAND

Corporate Headquarters

FLIR Systems, Inc.
2770 SW Parkway Avenue
Wilsonville, OR 97070 USA
Telephone: +1 503-498-3547

Firmware Updates

To check for MR176 firmware updates please visit the technical support website (above) for complete installation instructions.

Certificate of Conformity and ISO-9001 Quality Management System

FLIR Commercial Systems, Inc., an ISO 9001:2008 certified company, hereby certify that our instruments meet or exceed the specifications stated in the user manuals.

This instrument was produced under the stringent guidelines of FLIR Commercial System's certified ISO-9001 Quality Management System from design to delivery. All instruments are calibrated and inspected to meet the stated specifications.

FLIR Commercial Systems, Inc. inspects its incoming shipments using an approved sampling plan with an Acceptable Quality Level (AQL). All incoming inspections are performed using test equipment that is traceable to National Standards. Our ISO-9001 Quality Management System extends to aftermarket support where tested quality procedures are applied to customer support, service, calibration and repair processes.

This instrument will provide years of reliable service when used in accordance with the instructions provided in the User Guide. To have this device certified please contact your local service center.

Quality Assurance Management



Publication Identification No.: MR176-QS-mul
Release version: AA
Release Date: 2015 September
Language: EN