

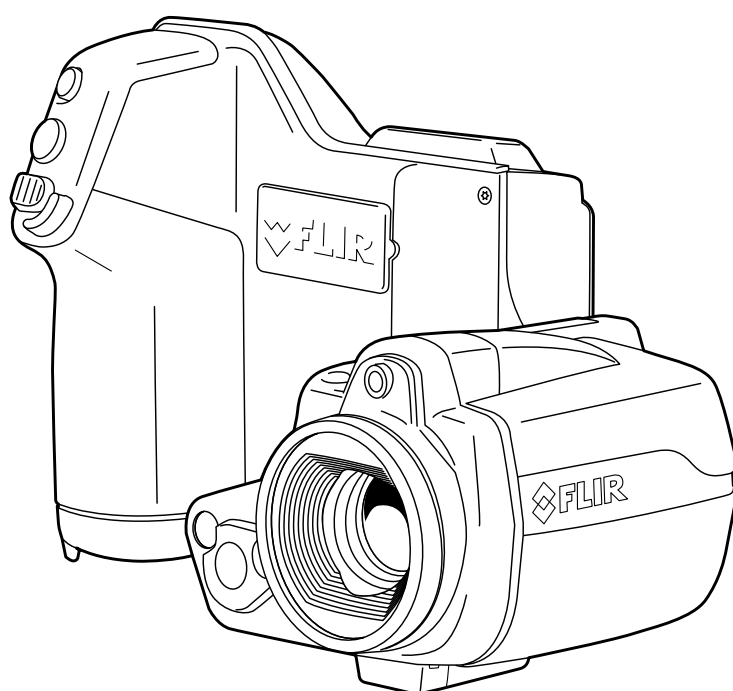

User's manual FLIR T4xx series



Important note

Before operating the device, you must read, understand, and follow all instructions, warnings, cautions, and legal disclaimers.

Důležitá poznámka

Před použitím zařízení si přečtěte veškeré pokyny, upozornění, varování a vyvázání se ze záruky, ujistěte se, že jim rozumíte, a řiďte se jimi.

Viktig meddelelse

Før du betjener enheden, skal du læse, forstå og følge alle anvisninger, advarsler, sikkerhedsforanstaltninger og ansvarsfraskrivelser.

Wichtiger Hinweis

Bevor Sie das Gerät in Betrieb nehmen, lesen, verstehen und befolgen Sie unbedingt alle Anweisungen, Warnungen, Vorsichtshinweise und Haftungsausschlüsse

Σημαντική σημείωση

Πριν από τη λειτουργία της συσκευής, πρέπει να διαβάσετε, να κατανοήσετε και να ακολουθήσετε όλες τις οδηγίες, προειδοποιήσεις, προφυλάξεις και νομικές αποποιήσεις.

Nota importante

Antes de usar el dispositivo, debe leer, comprender y seguir toda la información sobre instrucciones, advertencias, precauciones y renunciaciones de responsabilidad.

Tärkeä huomautus

Ennen laitteen käyttämistä on luettava ja ymmärrettävä kaikki ohjeet, vakavat varoitukset, varoitukset ja lakitiedotteet sekä noudatettava niitä.

Remarque importante

Avant d'utiliser l'appareil, vous devez lire, comprendre et suivre l'ensemble des instructions, avertissements, mises en garde et clauses légales de non-responsabilité.

Fontos megjegyzés

Az eszköz használatá elött figyelmesen olvassa el és tartsa be az összes utasítást, figyelmeztetést, óvintézkedést és jogi nyilatkozatot.

Nota importante

Prima di utilizzare il dispositivo, è importante leggere, capire e seguire tutte le istruzioni, avvertenze, precauzioni ed esclusioni di responsabilità legali.

重要な注意

デバイスをご使用になる前に、あらゆる指示、警告、注意事項、および免責条項をお読み頂き、その内容を理解して従ってください。

중요한 참고 사항

장치를 작동하기 전에 반드시 다음의 사용 설명서와 경고, 주의사항, 법적 책임제한을 읽고 이해하며 따라야 합니다.

Viktig

Før du bruker enheten, må du lese, forstå og følge instruksjoner, advarsler og informasjon om ansvarsfraskrivelse.

Belangrijke opmerking

Zorg ervoor dat u, voordat u het apparaat gaat gebruiken, alle instructies, waarschuwingen en juridische informatie hebt doorgelezen en begrepen, en dat u deze opvolgt en in acht neemt.

Ważna uwaga

Przed rozpoczęciem korzystania z urządzenia należy koniecznie zapoznać się z wszystkimi instrukcjami, ostrzeżeniami, przestrożami i uwagami prawnymi. Należy zawsze postępować zgodnie z zaleceniami tam zawartymi.

Nota importante

Antes de utilizar o dispositivo, deverá proceder à leitura e compreensão de todos os avisos, precauções, instruções e isenções de responsabilidade legal e assegurar-se do seu cumprimento.

Важное примечание

До того, как пользоваться устройством, вам необходимо прочитать и понять все предупреждения, предостережения и юридические ограничения ответственности и следовать им.

Viktig information

Innan du använder enheten måste du läsa, förstå och följa alla anvisningar, varningar, försiktighetsåtgärder och ansvarsfriskrivningar.

Önemli not

Cihazı çalıştırmadan önce tüm talimatları, uyarıları, ikazları ve yasal açıklamaları okumalı, anlamalı ve bunlara uymalısınız.

重要注意事項

在操作设备之前，您必须阅读、理解并遵循所有说明、警告、注意事项和法律免责声明。

重要注意事項

操作裝置之前，您務必閱讀、了解並遵循所有說明、警告、注意事項與法律免責聲明。



User's manual FLIR T4xx series



Table of contents

1	Disclaimers	1
1.1	Legal disclaimer	1
1.2	Usage statistics	1
1.3	Changes to registry	1
1.4	U.S. Government Regulations.....	1
1.5	Copyright	1
1.6	Quality assurance	1
1.7	Patents.....	1
1.8	EULA Terms	1
1.9	EULA Terms	1
2	Safety information	3
3	Notice to user	7
3.1	User-to-user forums	7
3.2	Calibration.....	7
3.3	Accuracy	7
3.4	Disposal of electronic waste	7
3.5	Training	7
3.6	Documentation updates	7
3.7	Important note about this manual.....	7
3.8	Note about authoritative versions.....	7
4	Customer help	8
4.1	General	8
4.2	Submitting a question	8
4.3	Downloads	9
5	Quick start guide	10
5.1	Procedure	10
6	List of accessories and services	11
7	A note about ergonomics	13
7.1	General	13
7.2	Figure	13
8	Camera parts	14
8.1	View from the rear.....	14
8.1.1	Figure.....	14
8.1.2	Explanation.....	14
8.2	View from the front	14
8.2.1	Figure.....	14
8.2.2	Explanation.....	14
8.3	View from the bottom.....	15
8.3.1	Figure.....	15
8.3.2	Explanation.....	15
8.4	Battery condition indicator	16
8.4.1	Figure.....	16
8.4.2	Explanation.....	16
8.5	Laser pointer	16
8.5.1	Figure.....	16
8.5.2	Laser warning label.....	16
8.5.3	Laser rules and regulations	17
9	Screen elements	18
9.1	Figure	18
9.2	Explanation	18
10	Navigating the menu system	19
10.1	Figure	19
10.2	Explanation	19

Table of contents

11	Pairing Bluetooth devices	20
11.1	General	20
11.2	Procedure	20
12	Configuring Wi-Fi	21
12.1	General	21
12.2	Setting up a peer-to-peer connection (most common use)	21
12.3	Connecting the camera to a wireless local area network (less common use).....	21
13	Handling the camera	22
13.1	Charging the battery.....	22
13.1.1	General.....	22
13.1.2	Using the combined power supply and battery charger to charge the battery when it is inside the camera	22
13.1.3	Using the combined power supply and battery charger to charge the battery when it is outside the camera	22
13.1.4	Using the stand-alone battery charger to charge the battery	22
13.2	Inserting the battery.....	23
13.2.1	Procedure	23
13.3	Removing the battery.....	24
13.3.1	Procedure	24
13.4	Turning on and turning off the camera.....	24
13.5	Adjusting the angle of lens	25
13.5.1	Figure.....	25
13.5.2	Procedure	25
13.6	Adjusting the infrared camera focus	25
13.6.1	Procedure	25
13.7	Mounting an additional lens.....	25
13.7.1	Procedure	25
13.8	Removing an additional infrared lens.....	27
13.8.1	Procedure	27
13.9	Attaching the sunshield	28
13.9.1	Procedure	28
13.10	Using the laser pointer	29
13.10.1	Figure.....	29
13.10.2	Procedure	29
13.11	Calibrating the compass.....	30
13.11.1	Procedure	30
13.12	Calibrating the touchscreen LCD.....	30
13.12.1	Figure.....	30
13.12.2	Procedure	30
13.13	Using the camera lamp as a flash	30
13.13.1	General.....	30
13.13.2	Procedure	30
14	Working with images	32
14.1	Saving an image	32
14.1.1	General.....	32
14.1.2	About UltraMax.....	32
14.1.3	Image capacity	32
14.1.4	Naming convention.....	32
14.1.5	Procedure	32
14.2	Previewing an image	33
14.2.1	General.....	33
14.2.2	Procedure	33
14.3	Opening a saved image.....	33

Table of contents

14.3.1	General.....	33
14.3.2	Procedure	33
14.4	Editing a saved image.....	33
14.4.1	General.....	33
14.4.2	Procedure	33
14.5	Adjusting an infrared image.....	34
14.5.1	General.....	34
14.5.2	Example 1	34
14.5.3	Example 2	34
14.5.4	Procedure	35
14.6	Performing a non-uniformity correction (NUC)	35
14.6.1	What is a non-uniformity correction?.....	35
14.6.2	When to perform a non-uniformity correction?	35
14.6.3	Procedure	35
14.7	Changing the temperature range	35
14.7.1	General.....	35
14.7.2	Procedure	36
14.8	Hiding overlay graphics (programmable button).....	36
14.8.1	General.....	36
14.8.2	Procedure	36
14.9	Changing the color palette	36
14.9.1	General.....	36
14.9.2	Procedure	36
14.10	Deleting an image	37
14.10.1	General.....	37
14.10.2	Procedure	37
14.11	Deleting all images.....	37
14.11.1	General.....	37
14.11.2	Procedure	37
14.12	Creating a PDF report in the camera	37
14.12.1	General.....	37
14.12.2	Naming convention.....	37
14.12.3	Procedure	37
15	Working with image modes.....	39
15.1	General	39
15.2	Image examples	39
15.3	Selecting the image mode	40
16	Working with measurement tools	41
16.1	General	41
16.2	Adding/removing measurement tools	41
16.3	Working with user presets.....	41
16.3.1	General.....	41
16.3.2	Procedure	41
16.4	Resizing or moving a measurement tool.....	42
16.4.1	General.....	42
16.4.2	Procedure	42
16.5	Changing object parameters	42
16.5.1	General.....	42
16.5.2	Types of parameters	42
16.5.3	Recommended values.....	43
16.5.4	Procedure	43
16.5.5	Related topics	44
16.6	Displaying values in the result table and displaying a graph.....	44
16.6.1	General.....	44
16.6.2	Procedure	45

Table of contents

16.7	Creating and setting up a difference calculation	45
16.7.1	General.....	45
16.7.2	Procedure	45
16.8	Setting a measurement alarm	46
16.8.1	General.....	46
16.8.2	Types of alarm	46
16.8.3	Alarm signals	46
16.8.4	Procedure	46
17	Fetching data from external FLIR meters	49
17.1	General	49
17.2	Supported FLIR meters	49
17.3	Technical support for external meters	49
17.4	Typical moisture measurement and documentation procedure	49
17.4.1	General.....	49
17.4.2	Procedure	49
17.5	More information	50
18	Working with color alarms and isotherms.....	51
18.1	Color alarms	51
18.1.1	General.....	51
18.1.2	Image examples	51
18.2	Setting up above, below, and interval alarms.....	52
18.3	Building isotherms	53
18.3.1	About the <i>Condensation alarm</i>	53
18.3.2	About the <i>Insulation alarm</i>	53
18.3.3	Setting up condensation and insulation alarms	53
19	Annotating images	54
19.1	General	54
19.2	Adding a note	54
19.2.1	General.....	54
19.2.2	Procedure	54
19.3	Adding a table.....	55
19.3.1	General.....	55
19.3.2	Procedure	55
19.4	Adding a voice annotation.....	55
19.4.1	General.....	55
19.4.2	Procedure	55
19.5	Adding a sketch.....	56
19.5.1	General.....	56
19.5.2	Procedure	56
20	Programming the camera (time lapse)	57
20.1	General	57
20.2	Procedure	57
21	Recording video clips	58
21.1	General	58
21.2	Procedure	58
22	Screening alarm	59
22.1	General	59
22.2	Procedure	59
23	Changing settings	60
23.1	General	60
23.1.1	<i>Define user presets</i>	60
23.1.2	<i>Save options</i>	60
23.1.3	<i>Programmable button</i>	60

Table of contents

	23.1.4	Reset options	60
	23.1.5	Device settings	60
	23.2	Procedure	61
24		Technical data	62
	24.1	Online field-of-view calculator	62
	24.2	Note about technical data	62
	24.3	Note about authoritative versions	62
	24.4	FLIR T420 (incl. Wi-Fi and 15° lens)	63
	24.5	FLIR T420 (incl. Wi-Fi and 45° lens)	69
	24.6	FLIR T420 (incl. Wi-Fi and Ext. cal.) (60 Hz)	75
	24.7	FLIR T420 (incl. Wi-Fi)	81
	24.8	FLIR T420 with SC kit (incl. Wi-Fi, incl. 45° lens)	87
	24.9	FLIR T420bx (incl. Wi-Fi and Ext. cal.) (60 Hz)	93
	24.10	FLIR T420bx (incl. Wi-Fi)	99
	24.11	FLIR T420bx 25° and 15° w/case	105
	24.12	FLIR T420bx 25° and 45° w/case	111
	24.13	FLIR T430sc (incl. Wi-Fi)	117
	24.14	FLIR T430sc with SC kit (incl. Wi-Fi)	123
	24.15	FLIR T440 (incl. Wi-Fi and Ext. cal.) (60 Hz)	128
	24.16	FLIR T440 (incl. Wi-Fi and 15° lens)	134
	24.17	FLIR T440 (incl. Wi-Fi and 45° lens)	140
	24.18	FLIR T440 (incl. Wi-Fi)	146
	24.19	FLIR T440bx (incl. Wi-Fi and Ext. cal.) (60 Hz)	152
	24.20	FLIR T440bx (incl. Wi-Fi)	158
	24.21	FLIR T440bx 25° and 15° w/case	164
	24.22	FLIR T440bx 25° and 45° w/case	170
	24.23	FLIR T450sc (incl. Wi-Fi)	176
	24.24	FLIR T450sc 25° and 45° w/case	182
	24.25	FLIR T460 (incl. Wi-Fi and Ext. cal.)	188
	24.26	FLIR T460 (incl. Wi-Fi)	194
	24.27	FLIR T460 25° and 15° w/case	200
	24.28	FLIR T460 25° and 45° w/case	206
25		Pin configurations	212
	25.1	Pin configuration for USB Mini-B connector	212
	25.2	Pin configuration for video connector	212
	25.3	Pin configuration for USB-A connector	212
	25.4	Pin configuration for power connector	213
26		Mechanical drawings	214
27		CE Declaration of conformity	222
28		Cleaning the camera	224
	28.1	Camera housing, cables, and other items	224
		28.1.1 Liquids	224
		28.1.2 Equipment	224
		28.1.3 Procedure	224
	28.2	Infrared lens	224
		28.2.1 Liquids	224
		28.2.2 Equipment	224
		28.2.3 Procedure	224
29		Application examples	225
	29.1	Moisture & water damage	225
		29.1.1 General	225
		29.1.2 Figure	225
	29.2	Faulty contact in socket	225
		29.2.1 General	225

Table of contents

	29.2.2 Figure.....	225
29.3	Oxidized socket.....	226
	29.3.1 General.....	226
	29.3.2 Figure.....	226
29.4	Insulation deficiencies.....	227
	29.4.1 General.....	227
	29.4.2 Figure.....	227
29.5	Draft	227
	29.5.1 General.....	227
	29.5.2 Figure.....	227
30	About FLIR Systems	229
	30.1 More than just an infrared camera	230
	30.2 Sharing our knowledge	230
	30.3 Supporting our customers.....	230
31	Glossary	232
32	Thermographic measurement techniques	235
	32.1 Introduction	235
	32.2 Emissivity.....	235
	32.2.1 Finding the emissivity of a sample.....	235
	32.3 Reflected apparent temperature.....	238
	32.4 Distance	239
	32.5 Relative humidity	239
	32.6 Other parameters.....	239
33	History of infrared technology.....	240
34	Theory of thermography.....	243
	34.1 Introduction	243
	34.2 The electromagnetic spectrum.....	243
	34.3 Blackbody radiation.....	243
	34.3.1 Planck's law	244
	34.3.2 Wien's displacement law.....	245
	34.3.3 Stefan-Boltzmann's law	246
	34.3.4 Non-blackbody emitters.....	247
	34.4 Infrared semi-transparent materials.....	249
35	The measurement formula.....	250
36	Emissivity tables	254
	36.1 References.....	254
	36.2 Tables	254

1.1 Legal disclaimer

All products manufactured by FLIR Systems are warranted against defective materials and workmanship for a period of one (1) year from the delivery date of the original purchase, provided such products have been under normal storage, use and service, and in accordance with FLIR Systems instruction.

Uncooled handheld infrared cameras manufactured by FLIR Systems are warranted against defective materials and workmanship for a period of two (2) years from the delivery date of the original purchase, provided such products have been under normal storage, use and service, and in accordance with FLIR Systems instruction, and provided that the camera has been registered within 60 days of original purchase.

Detectors for uncooled handheld infrared cameras manufactured by FLIR Systems are warranted against defective materials and workmanship for a period of ten (10) years from the delivery date of the original purchase, provided such products have been under normal storage, use and service, and in accordance with FLIR Systems instruction, and provided that the camera has been registered within 60 days of original purchase.

Products which are not manufactured by FLIR Systems but included in systems delivered by FLIR Systems to the original purchaser, carry the warranty, if any, of the particular supplier only. FLIR Systems has no responsibility whatsoever for such products.

The warranty extends only to the original purchaser and is not transferable. It is not applicable to any product which has been subjected to misuse, neglect, accident or abnormal conditions of operation. Expendable parts are excluded from the warranty.

In the case of a defect in a product covered by this warranty the product must not be further used in order to prevent additional damage. The purchaser shall promptly report any defect to FLIR Systems or this warranty will not apply.

FLIR Systems will, at its option, repair or replace any such defective product free of charge if, upon inspection, it proves to be defective in material or workmanship and provided that it is returned to FLIR Systems within the said one-year period.

FLIR Systems has no other obligation or liability for defects than those set forth above.

No other warranty is expressed or implied. FLIR Systems specifically disclaims the implied warranties of merchantability and fitness for a particular purpose.

FLIR Systems shall not be liable for any direct, indirect, special, incidental or consequential loss or damage, whether based on contract, tort or any other legal theory.

This warranty shall be governed by Swedish law.

Any dispute, controversy or claim arising out of or in connection with this warranty, shall be finally settled by arbitration in accordance with the Rules of the Arbitration Institute of the Stockholm Chamber of Commerce. The place of arbitration shall be Stockholm. The language to be used in the arbitral proceedings shall be English.

1.2 Usage statistics

FLIR Systems reserves the right to gather anonymous usage statistics to help maintain and improve the quality of our software and services.

1.3 Changes to registry

The registry entry HKEY_LOCAL_MACHINE\SYSTEM\CurrentControlSet\Control\Lsa\ImCompatibilityLevel will be automatically changed to level 2 if the FLIR Camera Monitor service detects a FLIR camera connected to the computer with a USB cable. The modification will only be executed if the camera device implements a remote network service that supports network logons.

1.4 U.S. Government Regulations

This product may be subject to U.S. Export Regulations. Please send any inquiries to exportquestions@flir.com.

1.5 Copyright

© 2016, FLIR Systems, Inc. All rights reserved worldwide. No parts of the software including source code may be reproduced, transmitted, transcribed or translated into any language or computer language in any form or by any means, electronic, magnetic, optical, manual or otherwise, without the prior written permission of FLIR Systems.

The documentation must not, in whole or part, be copied, photocopied, reproduced, translated or transmitted to any electronic medium or machine readable form without prior consent, in writing, from FLIR Systems.

Names and marks appearing on the products herein are either registered trademarks or trademarks of FLIR Systems and/or its subsidiaries. All other trademarks, trade names or company names referenced herein are used for identification only and are the property of their respective owners.

1.6 Quality assurance

The Quality Management System under which these products are developed and manufactured has been certified in accordance with the ISO 9001 standard.

FLIR Systems is committed to a policy of continuous development; therefore we reserve the right to make changes and improvements on any of the products without prior notice.

1.7 Patents

One or several of the following patents and/or design patents may apply to the products and/or features. Additional pending patents and/or pending design patents may also apply.

000279476-0001; 000439161; 000499579-0001; 000653423; 000726344; 000859020; 001106306-0001; 001707738; 001707746; 001707787; 001776519; 001954074; 002021543; 002058180; 002249953; 002531178; 0600574-8; 1144833; 1182246; 1182620; 1285345; 1299699; 1325808; 1336775; 1391114; 1402918; 1404291; 1411581; 1415075; 1421497; 1458284; 1678485; 1732314; 2106017; 2107799; 2381417; 3006596; 3006597; 466540; 483782; 484155; 4889913; 5177595; 60122153.2; 602004011681.5-08; 6707044; 68657; 7034300; 7110035; 7154093; 7157705; 7237946; 7312822; 7332716; 7336823; 7544944; 7667198; 7809258 B2; 7826736; 8,153,971; 8,823,803; 8,853,631; 8018649 B2; 8212210 B2; 8289372; 8354639 B2; 8384783; 8520970; 8565547; 8595689; 8599262; 8654239; 8680468; 8803093; D540838; D549758; D579475; D584755; D599,392; D615,113; D664,580; D664,581; D665,004; D665,440; D677298; D710,424 S; D718801; D16702302-9; D16903617-9; D17002221-6; D17002891-5; D17002892-3; D17005799-0; DM/057692; DM/061609; EP 2115696 B1; EP2315433; SE 0700240-5; US 8340414 B2; ZL 201330267619.5; ZL01823221.3; ZL01823226.4; ZL02331553.9; ZL02331554.7; ZL200480034894.0; ZL200530120994.2; ZL200610088759.5; ZL200630130114.4; ZL200730151141.4; ZL200730339504.7; ZL200820105768.8; ZL200830128581.2; ZL200880105236.4; ZL200880105769.2; ZL200930190061.9; ZL201030176127.1; ZL201030176130.3; ZL201030176157.2; ZL201030595931.3; ZL201130442354.9; ZL201230471744.3; ZL201230620731.8.







1.8 EULA Terms











- You have acquired a device ("INFRARED CAMERA") that includes software licensed by FLIR Systems AB from Microsoft Licensing, GP or its affiliates ("MS"). Those installed software products of MS origin, as well as associated media, printed materials, and "online" or electronic documentation ("SOFTWARE") are protected by international intellectual property laws and treaties. The SOFTWARE is licensed, not sold. All rights reserved.
- IF YOU DO NOT AGREE TO THIS END USER LICENSE AGREEMENT ("EULA"), DO NOT USE THE DEVICE OR COPY THE SOFTWARE. INSTEAD, PROMPTLY CONTACT FLIR Systems AB FOR INSTRUCTIONS ON RETURN OF THE UNUSED DEVICE(S) FOR A REFUND. ANY USE OF THE SOFTWARE, INCLUDING BUT NOT LIMITED TO USE ON THE DEVICE, WILL CONSTITUTE YOUR AGREEMENT TO THIS EULA (OR RATIFICATION OF ANY PREVIOUS CONSENT).
- **GRANT OF SOFTWARE LICENSE.** This EULA grants you the following license:
 - You may use the SOFTWARE only on the DEVICE.
 - **NOT FAULT TOLERANT.** THE SOFTWARE IS NOT FAULT TOLERANT. FLIR Systems AB HAS INDEPENDENTLY DETERMINED HOW TO USE THE SOFTWARE IN THE DEVICE, AND MS HAS RELIED UPON FLIR Systems AB TO CONDUCT SUFFICIENT TESTING TO DETERMINE THAT THE SOFTWARE IS SUITABLE FOR SUCH USE.
 - **NO WARRANTIES FOR THE SOFTWARE.** THE SOFTWARE is provided "AS IS" and with all faults. THE ENTIRE RISK AS TO SATISFACTORY QUALITY, PERFORMANCE, ACCURACY, AND EFFORT (INCLUDING LACK OF NEGLIGENCE) IS WITH YOU. ALSO, THERE IS NO WARRANTY AGAINST INTERFERENCE WITH YOUR ENJOYMENT OF THE SOFTWARE OR AGAINST INFRINGEMENT. IF YOU HAVE RECEIVED ANY WARRANTIES REGARDING THE DEVICE OR THE SOFTWARE, THOSE WARRANTIES DO NOT ORIGINATE FROM, AND ARE NOT BINDING ON, MS.
 - No Liability for Certain Damages. **EXCEPT AS PROHIBITED BY LAW, MS SHALL HAVE NO LIABILITY FOR ANY INDIRECT, SPECIAL, CONSEQUENTIAL OR INCIDENTAL DAMAGES ARISING FROM OR IN CONNECTION WITH THE USE OR PERFORMANCE OF THE SOFTWARE. THIS LIMITATION SHALL APPLY EVEN IF ANY REMEDY FAILS OF ITS ESSENTIAL PURPOSE. IN NO EVENT SHALL MS BE LIABLE FOR ANY AMOUNT IN EXCESS OF U.S. TWO HUNDRED FIFTY DOLLARS (U.S.\$250.00).**
 - **Limitations on Reverse Engineering, Decompilation, and Disassembly.** You may not reverse engineer, decompile, or disassemble the SOFTWARE, except and only to the extent that such activity is expressly permitted by applicable law notwithstanding this limitation.
 - **SOFTWARE TRANSFER ALLOWED BUT WITH RESTRICTIONS.** You may permanently transfer rights under this EULA only as part of a permanent sale or transfer of the Device, and only if the recipient agrees to this EULA. If the SOFTWARE is an upgrade, any transfer must also include all prior versions of the SOFTWARE.
 - **EXPORT RESTRICTIONS.** You acknowledge that SOFTWARE is subject to U.S. export jurisdiction. You agree to comply with all applicable international and national laws that apply to the SOFTWARE, including the U.S. Export Administration Regulations, as well as end-user, end-use and destination restrictions issued by U.S. and other governments. For additional information see <http://www.microsoft.com/exporting/>.











1.9 EULA Terms







Qt4 Core and Qt4 GUI, Copyright ©2013 Nokia Corporation and FLIR Systems AB. This Qt library is a free software; you can redistribute it and/or modify it under the terms of the GNU Lesser General Public License as published by the Free Software Foundation; either version 2.1 of the License, or (at your option) any later version. This library is distributed in the hope that it will be useful, but WITHOUT ANY WARRANTY; without even the implied warranty of MERCHANTABILITY or FITNESS FOR A PARTICULAR PURPOSE. See the GNU Lesser General Public License, <http://www.gnu.org/licenses/lgpl-2.1>.

html. The source code for the libraries Qt4 Core and Qt4 GUI may be requested from FLIR Systems AB.

 WARNING
<p>Applicability: Class B digital devices.</p> <p>This equipment has been tested and found to comply with the limits for a Class B digital device, pursuant to Part 15 of the FCC Rules. These limits are designed to provide reasonable protection against harmful interference in a residential installation. This equipment generates, uses and can radiate radio frequency energy and, if not installed and used in accordance with the instructions, may cause harmful interference to radio communications. However, there is no guarantee that interference will not occur in a particular installation. If this equipment does cause harmful interference to radio or television reception, which can be determined by turning the equipment off and on, the user is encouraged to try to correct the interference by one or more of the following measures:</p> <ul style="list-style-type: none"> • Reorient or relocate the receiving antenna. • Increase the separation between the equipment and receiver. • Connect the equipment into an outlet on a circuit different from that to which the receiver is connected. • Consult the dealer or an experienced radio/TV technician for help.
 WARNING
<p>Applicability: Digital devices subject to 15.19/RSS-210.</p> <p>NOTICE: This device complies with Part 15 of the FCC Rules and with RSS-210 of Industry Canada. Operation is subject to the following two conditions:</p> <ol style="list-style-type: none"> 1. this device may not cause harmful interference, and 2. this device must accept any interference received, including interference that may cause undesired operation.
 WARNING
<p>Applicability: Digital devices subject to 15.21.</p> <p>NOTICE: Changes or modifications made to this equipment not expressly approved by FLIR Systems may void the FCC authorization to operate this equipment.</p>
 WARNING
<p>Applicability: Digital devices subject to 2.1091/2.1093/OET Bulletin 65.</p> <p>Radiofrequency radiation exposure Information: The radiated output power of the device is below the FCC/IC radio frequency exposure limits. Nevertheless, the device shall be used in such a manner that the potential for human contact during normal operation is minimized.</p>
 WARNING
<p>Applicability: Cameras with one or more laser pointers.</p> <p>Do not look directly into the laser beam. The laser beam can cause eye irritation.</p>
 WARNING
<p>Applicability: Cameras with one or more batteries.</p> <p>Do not disassemble or do a modification to the battery. The battery contains safety and protection devices which, if damage occurs, can cause the battery to become hot, or cause an explosion or an ignition.</p>
 WARNING
<p>Applicability: Cameras with one or more batteries.</p> <p>If there is a leak from the battery and you get the fluid in your eyes, do not rub your eyes. Flush well with water and immediately get medical care. The battery fluid can cause injury to your eyes if you do not do this.</p>

 WARNING
Applicability: Cameras with one or more batteries. Do not continue to charge the battery if it does not become charged in the specified charging time. If you continue to charge the battery, it can become hot and cause an explosion or ignition. Injury to persons can occur.
 WARNING
Applicability: Cameras with one or more batteries. Only use the correct equipment to remove the electrical power from the battery. If you do not use the correct equipment, you can decrease the performance or the life cycle of the battery. If you do not use the correct equipment, an incorrect flow of current to the battery can occur. This can cause the battery to become hot, or cause an explosion. Injury to persons can occur.
 WARNING
Make sure that you read all applicable MSDS (Material Safety Data Sheets) and warning labels on containers before you use a liquid. The liquids can be dangerous. Injury to persons can occur.
 CAUTION
Do not point the infrared camera (with or without the lens cover) at strong energy sources, for example, devices that cause laser radiation, or the sun. This can have an unwanted effect on the accuracy of the camera. It can also cause damage to the detector in the camera.
 CAUTION
Do not use the camera in temperatures more than +50°C (+122°F), unless other information is specified in the user documentation or technical data. High temperatures can cause damage to the camera.
 CAUTION
Applicability: Cameras with one or more laser pointers. To prevent damage, put the protective cap on the laser pointer when you do not operate the laser pointer. Damage to the laser pointer can occur if you do not do this.
 CAUTION
Applicability: Cameras with one or more batteries. Do not attach the batteries directly to a car's cigarette lighter socket, unless FLIR Systems supplies a specific adapter to connect the batteries to a cigarette lighter socket. Damage to the batteries can occur.
 CAUTION
Applicability: Cameras with one or more batteries. Do not connect the positive terminal and the negative terminal of the battery to each other with a metal object (such as wire). Damage to the batteries can occur.
 CAUTION
Applicability: Cameras with one or more batteries. Do not get water or salt water on the battery, or permit the battery to become wet. Damage to the batteries can occur.
 CAUTION
Applicability: Cameras with one or more batteries. Do not make holes in the battery with objects. Damage to the battery can occur.

 CAUTION
Applicability: Cameras with one or more batteries. Do not hit the battery with a hammer. Damage to the battery can occur.
 CAUTION
Applicability: Cameras with one or more batteries. Do not put your foot on the battery, hit it or cause shocks to it. Damage to the battery can occur.
 CAUTION
Applicability: Cameras with one or more batteries. Do not put the batteries in or near a fire, or into direct sunlight. When the battery becomes hot, the built-in safety equipment becomes energized and can stop the battery charging procedure. If the battery becomes hot, damage can occur to the safety equipment and this can cause more heat, damage or ignition of the battery.
 CAUTION
Applicability: Cameras with one or more batteries. Do not put the battery on a fire or increase the temperature of the battery with heat. Damage to the battery and injury to persons can occur.
 CAUTION
Applicability: Cameras with one or more batteries. Do not put the battery on or near fires, stoves, or other high-temperature locations. Damage to the battery and injury to persons can occur.
 CAUTION
Applicability: Cameras with one or more batteries. Do not solder directly onto the battery. Damage to the battery can occur.
 CAUTION
Applicability: Cameras with one or more batteries. Do not use the battery if, when you use, charge, or put the battery in storage, there is an unusual smell from the battery, the battery feels hot, changes color, changes shape, or is in an unusual condition. Speak with your sales office if one or more of these problems occurs. Damage to the battery and injury to persons can occur.
 CAUTION
Applicability: Cameras with one or more batteries. Only use a specified battery charger when you charge the battery. Damage to the battery can occur if you do not do this.
 CAUTION
Applicability: Cameras with one or more batteries. Only use a specified battery for the camera. Damage to the camera and the battery can occur if you do not do this.
 CAUTION
Applicability: Cameras with one or more batteries. The temperature range through which you can charge the battery is $\pm 0^{\circ}\text{C}$ to $+45^{\circ}\text{C}$ ($+32^{\circ}\text{F}$ to $+113^{\circ}\text{F}$), unless other information is specified in the user documentation or technical data. If you charge the battery at temperatures out of this range, it can cause the battery to become hot or to break. It can also decrease the performance or the life cycle of the battery.

 CAUTION
<p>Applicability: Cameras with one or more batteries.</p> <p>The temperature range through which you can remove the electrical power from the battery is -15°C to +50°C (+5°F to +122°F), unless other information is specified in the user documentation or technical data. If you operate the battery out of this temperature range, it can decrease the performance or the life cycle of the battery.</p>
 CAUTION
<p>Applicability: Cameras with one or more batteries.</p> <p>When the battery is worn, apply insulation to the terminals with adhesive tape or equivalent materials before you discard it. Damage to the battery and injury to persons can occur if you do not do this.</p>
 CAUTION
<p>Applicability: Cameras with one or more batteries.</p> <p>Remove any water or moisture on the battery before you install it. Damage to the battery can occur if you do not do this.</p>
 CAUTION
<p>Do not apply solvents or equivalent liquids to the camera, the cables, or other items. Damage to the battery and injury to persons can occur.</p>
 CAUTION
<p>Be careful when you clean the infrared lens. The lens has an anti-reflective coating which is easily damaged. Damage to the infrared lens can occur.</p>
 CAUTION
<p>Do not use too much force to clean the infrared lens. This can cause damage to the anti-reflective coating.</p>
 NOTE
<p>The encapsulation rating is only applicable when all the openings on the camera are sealed with their correct covers, hatches, or caps. This includes the compartments for data storage, batteries, and connectors.</p>

3.1 User-to-user forums

Exchange ideas, problems, and infrared solutions with fellow thermographers around the world in our user-to-user forums. To go to the forums, visit:

<http://www.infraredtraining.com/community/boards/>

3.2 Calibration

We recommend that you send in the camera for calibration once a year. Contact your local sales office for instructions on where to send the camera.

3.3 Accuracy

For very accurate results, we recommend that you wait 5 minutes after you have started the camera before measuring a temperature.

3.4 Disposal of electronic waste



As with most electronic products, this equipment must be disposed of in an environmentally friendly way, and in accordance with existing regulations for electronic waste.

Please contact your FLIR Systems representative for more details.

3.5 Training

To read about infrared training, visit:

- <http://www.infraredtraining.com>
- <http://www.irtraining.com>
- <http://www.irtraining.eu>

3.6 Documentation updates

Our manuals are updated several times per year, and we also issue product-critical notifications of changes on a regular basis.

To access the latest manuals and notifications, go to the Download tab at:

<http://support.flir.com>

It only takes a few minutes to register online. In the download area you will also find the latest releases of manuals for our other products, as well as manuals for our historical and obsolete products.

3.7 Important note about this manual

FLIR Systems issues generic manuals that cover several cameras within a model line.

This means that this manual may contain descriptions and explanations that do not apply to your particular camera model.

3.8 Note about authoritative versions

The authoritative version of this publication is English. In the event of divergences due to translation errors, the English text has precedence.

Any late changes are first implemented in English.

FLIR Customer Support Center

Home Answers Ask a Question Product Registration Downloads My Stuff Service

FLIR Customer support

Get the most out of your FLIR products

Get Support for Your FLIR Products

Welcome to the FLIR Customer Support Center. This portal will help you as a FLIR customer to get the most out of your FLIR products. The portal gives you access to:

- The FLIR Knowledgebase
- Ask our support team (requires registration)
- Software and documentation (requires registration)
- FLIR service contacts











Find Answers
We store all resolved problems in our solution database. Search by product, category, keywords, or phrases.

Search by Keyword

[Search All Answers](#)

[See All Popular Answers](#)

To find a datasheet for a current product, click on a picture.
To find a datasheet for a legacy product, click [here](#).

[FLIR Ex](#) [FLIR Exx](#) [FLIR Kxx](#) [FLIR T4xx](#) [FLIR T6xx](#) [FLIR G3xx](#)
     
[ThermaCAM™ GasFindIR](#) [FLIR GF3xx](#) [FLIR AX](#) [FLIR Ax5](#) [FLIR A3xx](#) [More...](#)
    

Product catalog
Please right-click the links below and select Save Target As... to save the file.

 US Letter (28 Mb)
A4 (27.4 Mb)

Accessories

[Important legal disclaimer, dangers, warnings, and cautions](#)

4.1 General

For customer help, visit:

<http://support.flir.com>

4.2 Submitting a question

To submit a question to the customer help team, you must be a registered user. It only takes a few minutes to register online. If you only want to search the knowledgebase for existing questions and answers, you do not need to be a registered user.

When you want to submit a question, make sure that you have the following information to hand:

- The camera model
- The camera serial number
- The communication protocol, or method, between the camera and your device (for example, HDMI, Ethernet, USB, or FireWire)
- Device type (PC/Mac/iPhone/iPad/Android device, etc.)
- Version of any programs from FLIR Systems
- Full name, publication number, and revision number of the manual

4.3 Downloads

On the customer help site you can also download the following, when applicable for the product:

- Firmware updates for your infrared camera.
- Program updates for your PC/Mac software.
- Freeware and evaluation versions of PC/Mac software.
- User documentation for current, obsolete, and historical products.
- Mechanical drawings (in *.dxf and *.pdf format).
- Cad data models (in *.stp format).
- Application stories.
- Technical datasheets.
- Product catalogs.

5.1 Procedure

Follow this procedure:

1. Put a battery into the battery compartment.
2. Charge the battery for 4 hours before starting the camera for the first time.
3. Insert a memory card into the card slot.
4. Push the On/off button  to turn on the camera.
5. Aim the camera toward the object of interest.
6. Adjust the focus.

Note It is very important to adjust the focus correctly. Incorrect focus adjustment affects how the image modes work. It also affects the temperature measurement.

7. Push the Autofocus/save button fully down to save an image.
8. Go to <http://support.flir.com/tools> and download FLIR Tools.
9. Install FLIR Tools on your computer.
10. Start FLIR Tools.
11. Connect the camera to the computer using a USB cable.
12. Import the images into FLIR Tools.
13. Select one or more images.
14. Click *Generate report*.
15. Click *Export* to export the report as a PDF file.
16. Send the PDF report to your client.

Product name	Part number
2-bay battery charger, incl. power supply with multi plugs	T197650
Battery	1196398ACC
Battery package	T197667
Bluetooth Headset	T197771ACC
Calibration including General maintenance T2xx-T4xx series	T199802
Cigarette lighter adapter kit, 12 VDC, 1.2 m/3.9 ft.	T198509
Close-up 2x (50 µm) incl. case	T197214
Close-up 4x (100 µm) incl. case	T197215
FLIR IR Camera Player	DSW-10000
FLIR Reporter Professional (license only)	T198586
FLIR ResearchIR Max + HSDR 4 (hardware sec. dev.)	T198697
FLIR ResearchIR Max + HSDR 4 (printed license key)	T199014
FLIR ResearchIR Max + HSDR 4 Upgrade (printed license key)	T199044
FLIR ResearchIR Max 4 (hardware sec. dev.)	T198696
FLIR ResearchIR Max 4 (printed license key)	T199013
FLIR ResearchIR Max 4 Upgrade (printed license key)	T199043
FLIR ResearchIR Standard 4 (hardware sec. dev.)	T198731
FLIR ResearchIR Standard 4 (printed license key)	T199012
FLIR ResearchIR Standard 4 Upgrade (printed license key)	T199042
FLIR Tools	T198584
FLIR Tools+ (download card incl. license key)	T198583
Hard transport case for FLIR T/B2xx-4xx	T198370ACC
High temp. option +1200°C (+2192°F)	T197000
IR lens, 4 mm (90°) with case and mounting support for T/B2xx-4xx	T197412
IR lens, 76 mm (6°) with case and mounting support for T/B-200/400	T197408
IR lens, f = 10 mm, 45° incl. case	1196960
IR lens, f = 30 mm, 15° incl. case	1196961
IR Window 2 in.	19250-100
IR Window 3 in.	19251-100
IR Window 4 in.	19252-100
Memory card SDHC 4 GB	T911230ACC
Neck strap	T198499
One year extended warranty for T2xx-4xx series	T199815
Pouch	1124545
Pouch for FLIR T6xx and T4xx series	T198495
Power supply, incl. multi plugs	T910814
SS IR Window 2 in.	19250-200
SS IR Window 3 in.	19251-200

Product name	Part number
SS IR Window 4 in.	19252-200
Sun shield	T198493
Tool belt	T911093
USB cable Std A <-> Mini-B	1910423
Video cable	1910582ACC

Note FLIR Systems reserves the right to discontinue models, parts or accessories, and other items, or to change specifications at any time without prior notice.

A note about ergonomics

7.1 General

To prevent strain-related injuries, it is important that you hold the camera ergonomically correct. This section gives advice and examples on how to hold the camera.

Note Please note the following:

- Always tilt the touch-screen LCD to suit your work position.
- When you hold the camera, make sure that you support the optics housing with your left hand too. This decreases the strain on your right hand.

7.2 Figure

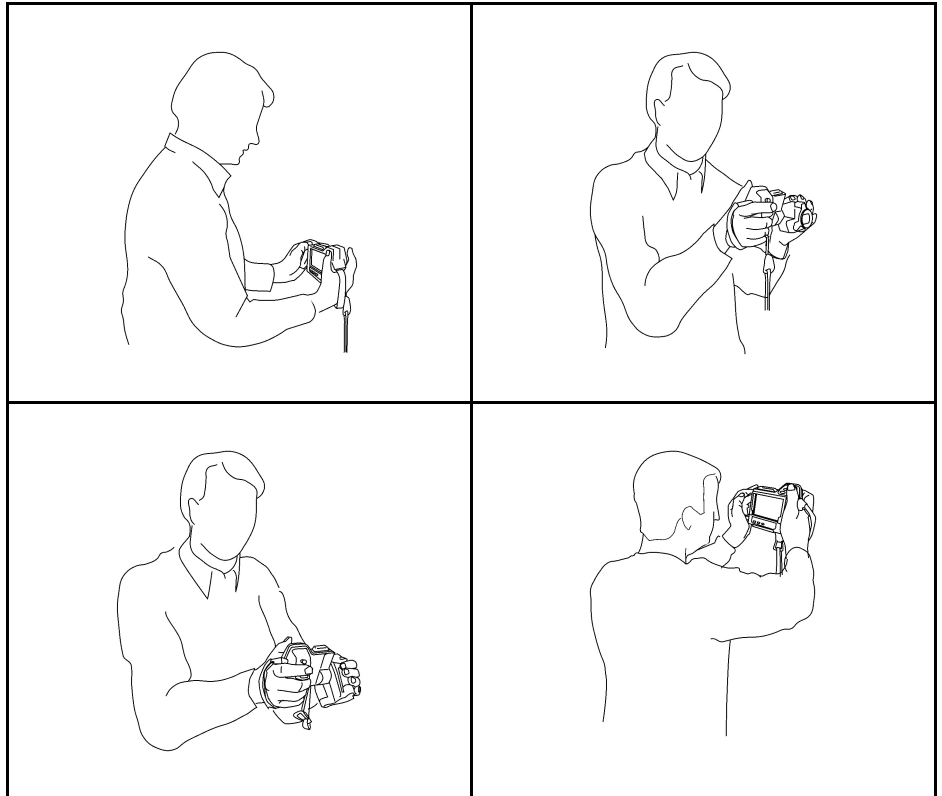

8.1 View from the rear

8.1.1 Figure

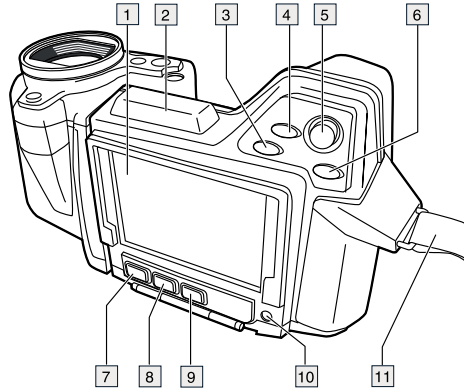

8.1.2 Explanation

1. Touch-screen LCD.
2. Antenna for wireless communication.
3. Digital zoom button.
4. Programmable button.
5. Joystick with push-button functionality.
6. Back button.
7. Camera lamp button.
8. Button to switch between automatic and manual image adjustment mode.
9. Image archive button.
10. On/off button.
11. Hand strap.

8.2 View from the front

8.2.1 Figure

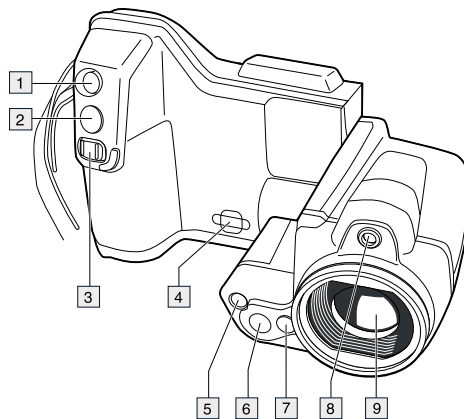

8.2.2 Explanation

1. Laser pointer button. Push to activate the laser pointer.
2. Autofocus/save button.
3. Focus button. Move left/right to focus the camera.
4. Attachment point for the neck strap.
5. Camera lamp.
6. Digital camera.
7. Release button for additional infrared lenses.

8. Laser pointer.

Note The laser pointer may not be enabled in all markets.

9. Infrared lens.

8.3 View from the bottom

8.3.1 Figure

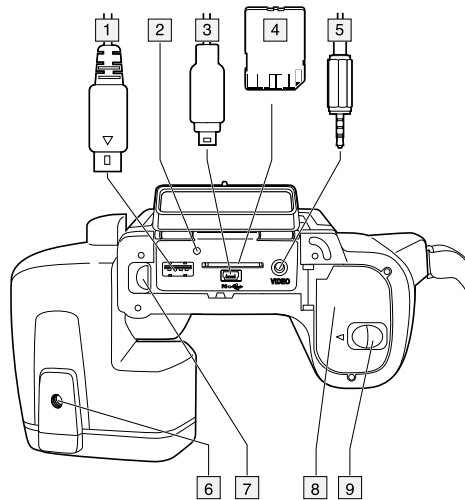

8.3.2 Explanation

1. USB-A cable (to connect an external USB device to the camera).
2. Indicator showing that the memory card is busy.

Note

- Do not eject the memory card when this LED is flashing.
- Do not connect the camera to a computer when this LED is flashing.

3. USB Mini-B cable (to connect the camera to a computer).
4. Memory card.
5. Video cable (composite video).
6. Tripod mount 1/4"-20.
7. Latch for the cover to the connector bay.
8. Battery compartment cover.
9. Latch for the battery compartment cover.

8.4 Battery condition indicator

8.4.1 Figure

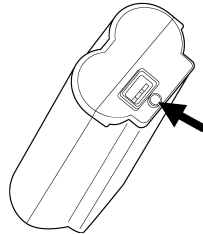

8.4.2 Explanation

Type of signal	Explanation
The green light flashes.	The power supply or the stand-alone battery charger is charging the battery.
The green light is continuous.	The battery is fully charged.
The green light is off.	The camera is using the battery (instead of the power supply).

8.5 Laser pointer

8.5.1 Figure

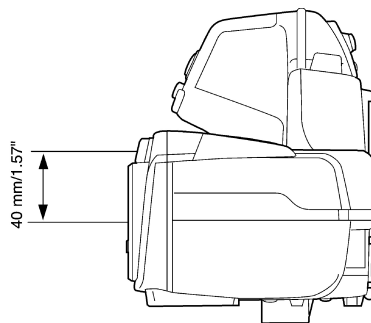

Figure 8.1 This figure shows the difference in position between the laser pointer and the optical center of the infrared lens.

	WARNING
Do not look directly into the laser beam. The laser beam can cause eye irritation.	

Note The laser pointer is enabled by a setting. Select (*Settings*) > *Device settings* > *Set up camera* > *Lamp & laser* > *Enable lamp & laser*.

Note The laser pointer may not be enabled in all markets.

Note The symbol is displayed on the screen when the laser pointer is on.

8.5.2 Laser warning label

A laser warning label with the following information is attached to the camera:

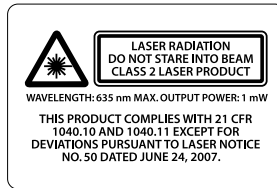

8.5.3 Laser rules and regulations

Wavelength: 635 nm. Maximum output power: 1 mW.

This product complies with 21 CFR 1040.10 and 1040.11 except for deviations pursuant to Laser Notice No. 50, dated June 24, 2007.

9.1 Figure

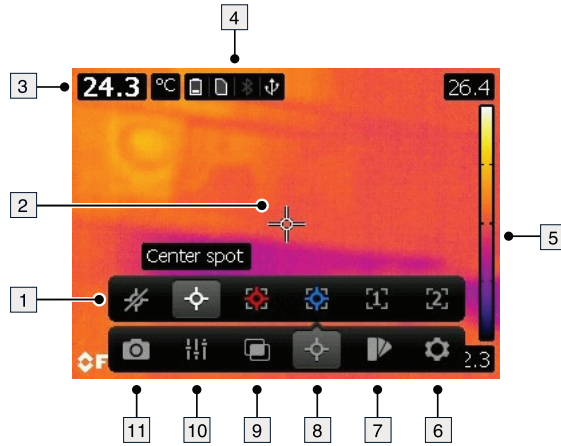

9.2 Explanation

1. Measurement toolbar.
2. Measurement tool (e.g., spotmeter).
3. Result table.
4. Status icons.
5. Temperature scale.
6. Settings toolbar button.
7. Color toolbar button.
8. Measurement toolbar button.
9. Image mode toolbar button.
10. Measurement parameters toolbar button.
11. Recording mode toolbar button.

10.1 Figure

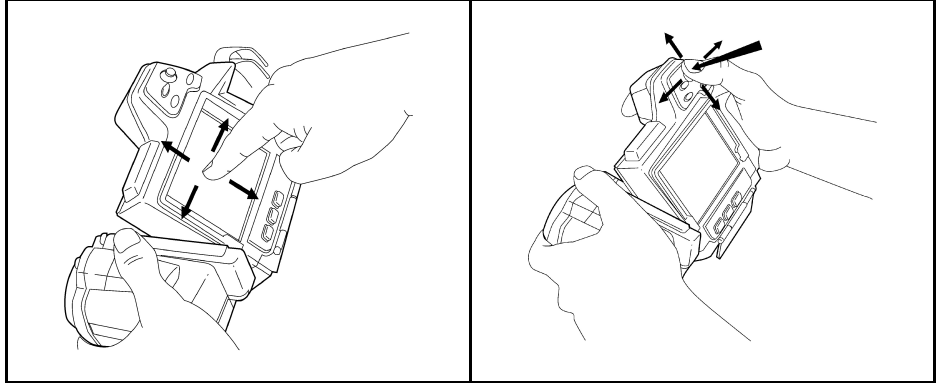

10.2 Explanation

The figure above shows the two ways to navigate the menu system in the camera:

- Using the index finger or a stylus pen specially designed for capacitive touch usage to navigate the menu system (left).
- Using the joystick to navigate the menu system (right).

You can also use a combination of the two.

In this manual it is assumed that the joystick is used, but most tasks can also be carried out using the index finger or a stylus pen.

11.1 General

Before you can use a Bluetooth device with the camera, you need to pair the devices.

11.2 Procedure

Follow this procedure:

1. Push the joystick to display the menu system.
2. Use the joystick to go to  (*Settings*).
3. Push the joystick to display the *Settings* menu.
4. Select *Device settings* and push the joystick.
5. Select *Bluetooth including METERLiNK* and push the joystick.
6. If the *Bluetooth* check box is unchecked, push the joystick to activate Bluetooth.
Note You also need to activate Bluetooth connectivity on the external device.
7. Select *Scan for Bluetooth devices* and push the joystick.
8. Wait until a list of available devices is displayed. This will take about 15 seconds.
9. When a Bluetooth device is found, select the device to add it, and begin the pairing procedure. The device is then ready to be used.

Note

- Only METERLiNK devices and Bluetooth-enabled headsets will appear in the list of available devices.
- You can add several devices.
- You can remove a device by selecting the device and then selecting *Unpair device*.
- After adding a METERLiNK device, such as the FLIR MR77 or FLIR DM93, the result from the meter will be visible in the result table and stored with the images. For more information, see section 17 *Fetching data from external FLIR meters*, page 49.
- After adding a Bluetooth-enabled headset, it is ready to be used for adding voice annotations.

12.1 General

Depending on your camera configuration, you can connect the camera to a wireless local area network (WLAN) using Wi-Fi, or let the camera provide Wi-Fi access to another device.

You can connect the camera in two different ways:

- *Most common use:* Setting up a peer-to-peer connection (also called an *ad hoc* or *P2P* connection). This method is primarily used with other devices, e.g., an iPhone or iPad.
- *Less common use:* Connecting the camera to a WLAN.

12.2 Setting up a peer-to-peer connection (most common use)

Follow this procedure:

1. Push the joystick to display the menu system.
2. Use the joystick to go to  (*Settings*).
3. Push the joystick to display the *Settings* menu.
4. Select *Device settings* and push the joystick.
5. Select *Wi-Fi* and push the joystick.
6. Select *Share* and push the joystick.
7. (Optional step.) To display and change the parameters, select *Settings* and push the joystick.
 - To change the channel (the channel that the camera is broadcasting on), select *Channel* and push the joystick.
 - To activate WEP (encryption algorithm), select *WEP* and push the joystick. This will check the *WEP* check box.
 - To change the WEP password, select *Password* and push the joystick.

Note These parameters are set for your camera's network. They will be used by the external device to connect that device to the network.

12.3 Connecting the camera to a wireless local area network (less common use)

Follow this procedure:

1. Push the joystick to display the menu system.
2. Use the joystick to go to  (*Settings*).
3. Push the joystick to display the *Settings* menu.
4. Select *Device settings* and push the joystick.
5. Select *Wi-Fi* and push the joystick.
6. Select *Connect to network* and push the joystick.
7. To display a list of the available networks, select *Networks* and push the joystick.
8. Select one of the available networks.

Password-protected networks are indicated with a padlock icon, and for these you will need to enter a password.

Note Some networks do not broadcast their existence. To connect to such a network, select *Settings* from the *Networks* list and push the joystick. Then select *Add network...* and set all parameters manually according to that network.

13.1 Charging the battery

Note You must charge the battery for 4 hours before you start using the camera for the first time.

13.1.1 General

You must charge the battery when a low battery voltage warning is displayed on the screen.

Follow one of these procedures to charge the battery:

- Use the combined power supply and battery charger to charge the battery when it is inside the camera.
- Use the combined power supply and battery charger to charge the battery when it is outside the camera.
- Use the stand-alone battery charger to charge the battery.

13.1.2 *Using the combined power supply and battery charger to charge the battery when it is inside the camera*

Note For brevity, the 'combined power supply and battery charger' is called the 'power supply' below.

13.1.2.1 Procedure

Follow this procedure:

1. Open the battery compartment cover.
2. Connect the power supply cable plug to the connector on the battery.
3. Connect the power supply mains-electricity plug to a mains socket.
4. Disconnect the power supply cable plug when the green light of the battery condition indicator is continuous.

See also:

For information about the battery condition indicator, see 8.4 *Battery condition indicator*, page 16.

13.1.3 *Using the combined power supply and battery charger to charge the battery when it is outside the camera*

Note For brevity, the 'combined power supply and battery charger' is called the 'power supply' below.

13.1.3.1 Procedure

Follow this procedure:

1. Put the battery on a flat surface.
2. Connect the power supply cable plug to the connector on the battery.
3. Connect the power supply mains-electricity plug to a mains socket.
4. Disconnect the power supply cable plug when the green light of the battery condition indicator is continuous.

See also:

For information about the battery condition indicator, see 8.4 *Battery condition indicator*, page 16.

13.1.4 *Using the stand-alone battery charger to charge the battery*

13.1.4.1 Procedure

Follow this procedure:

1. Put the battery in the stand-alone battery charger.

2. Connect the power supply cable plug to the connector on the stand-alone battery charger.
3. Connect the power supply mains-electricity plug to a mains socket.
4. Disconnect the power supply cable plug when the green light of the battery condition indicator is continuous.

See also:

For information about the battery condition indicator, see 8.4 *Battery condition indicator*, page 16.

13.2 Inserting the battery

Note Use a clean, dry cloth to remove any water or moisture on the battery before you insert it.

13.2.1 Procedure

Follow this procedure:

1. Push the release button on the battery compartment cover to unlock it.

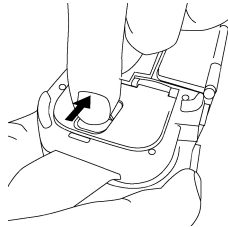

2. Open the cover to the battery compartment.

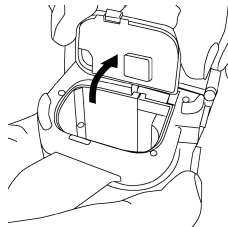

3. Push the battery into the battery compartment until the battery-locking mechanism engages.

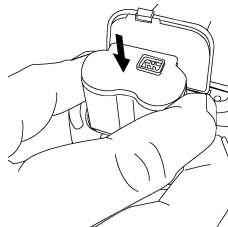

4. Close the cover to the battery compartment.

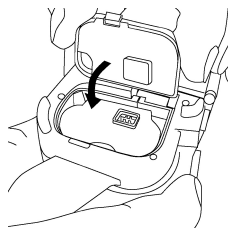

13.3 Removing the battery

13.3.1 Procedure

Follow this procedure:

1. Push the release button on the battery compartment cover to unlock it.

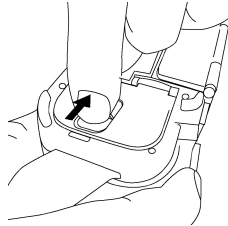

2. Open the cover to the battery compartment.



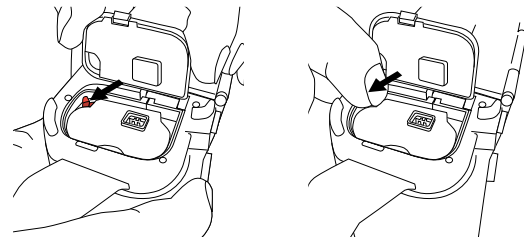

3. Push the red release button in the direction of the arrow to unlock the battery.

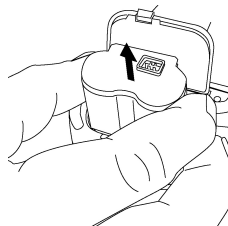

4. Pull out the battery from the battery compartment.



13.4 Turning on and turning off the camera

- Push the  button to turn on the camera.
- Push and hold the  button for less than 5 seconds to put the camera in standby mode. The camera then automatically turns off after 6 hours.
- Push and hold the  button for more than 10 seconds to turn off the camera.

13.5 Adjusting the angle of lens

13.5.1 Figure

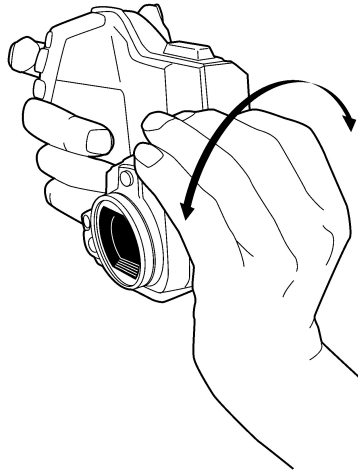

13.5.2 Procedure

To adjust the angle, tilt the lens up or down.

13.6 Adjusting the infrared camera focus

13.6.1 Procedure

To adjust the infrared camera focus, do one of the following:

- Push the focus button left for far focus.
- Push the focus button right for near focus.
- Push the Autofocus/save button halfway down to autofocus the camera.

Note It is important that you hold the camera steady while autofocus.

13.7 Mounting an additional lens

Note Do not touch the lens surface when you mount an infrared lens. If this happens, clean the lens according to the instructions in 28.2 *Infrared lens*, page 224.

13.7.1 Procedure

Follow this procedure:

1. Push the lens release button to unlock the lens cap.

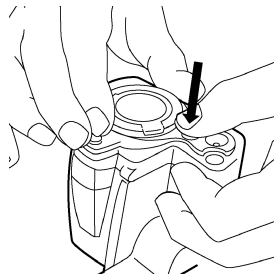

2. Rotate the lens cap 30° counter-clockwise (looking at the front of the lens).

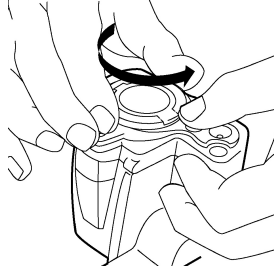

3. Carefully pull out the lens cap from the bayonet ring.

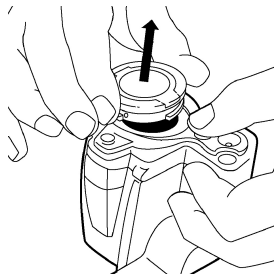

4. Correctly position the lens in front of the bayonet ring.

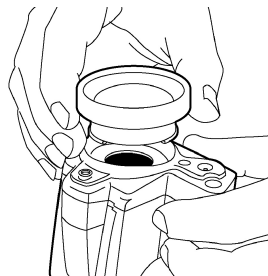

5. Carefully push the lens into position.

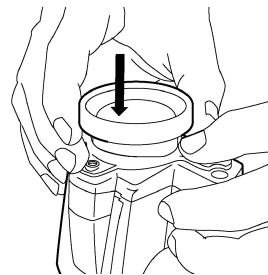

6. Rotate the lens 30° clockwise (looking at the front of the lens).



13.8 Removing an additional infrared lens

Note Do not touch the lens surface when you mount an infrared lens. If this happens, clean the lens according to the instructions in 28.2 *Infrared lens*, page 224. When you have removed the lens, put the lens caps on the lens immediately, to protect it from dust and fingerprints.

13.8.1 Procedure

Follow this procedure:

1. Push the lens release button to unlock the lens.

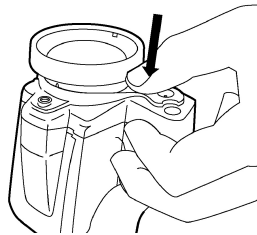

2. Rotate the lens counter-clockwise 30° (looking at the front of the lens).



3. Carefully pull out the lens from the bayonet ring.

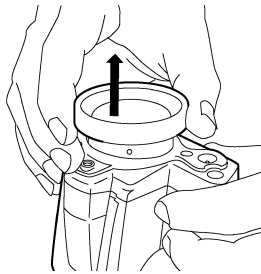

4. Correctly position the lens cap in front of the bayonet ring.

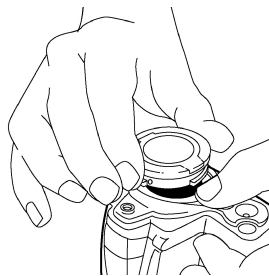

5. Carefully push the lens cap into position.

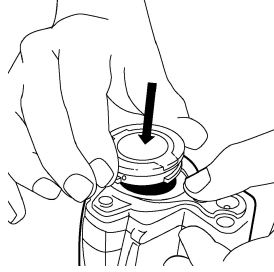

6. Rotate the lens cap 30° clockwise (looking at the front of the lens).

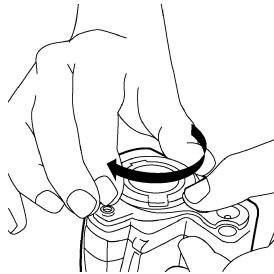

13.9 Attaching the sunshield

13.9.1 Procedure

Follow this procedure:

1. Align the two front tabs of the sunshield with the corresponding two notches at the top of the screen.

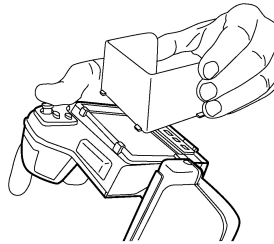

2. Push the front part of the sunshield into position. Make sure that the two tabs mate with the corresponding notches.

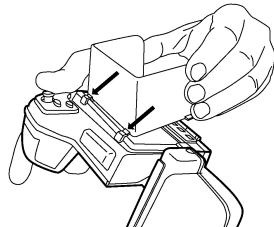

3. Carefully hold together the two rear wings of the sunshield.

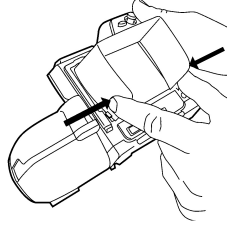

4. Push the rear part of the sunshield toward the screen, and then release your grip. Make sure that the two tabs mate with the corresponding notches.

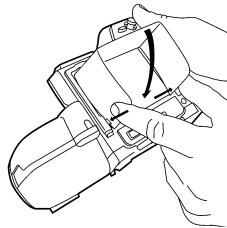

13.10 Using the laser pointer

Note The laser pointer is enabled by a setting. Select  (Settings) > Device settings > Set up camera > Lamp & laser > Enable lamp & laser.

13.10.1 Figure

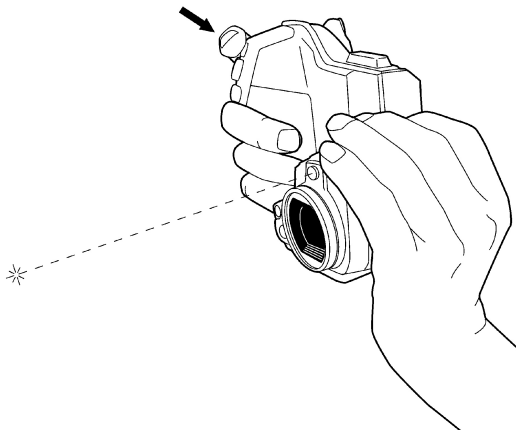

13.10.2 Procedure

Follow this procedure:

1. To turn on the laser pointer, push and hold the laser pointer button.
2. To turn off the laser pointer, release the laser pointer button.

Note The laser pointer may not be enabled in all markets.

Note The symbol  is displayed on the screen when the laser pointer is on.

13.11 Calibrating the compass

13.11.1 Procedure

Follow this procedure:

1. Push the joystick to display the menu system.
2. Use the joystick to go to  (*Settings*).
3. Push the joystick to display the *Settings* menu.
4. Select *Device settings* and push the joystick.
5. Select *Compass* and push the joystick.
6. Select *Compass*. If the *Compass* check box is unchecked, push the joystick to enable the compass.
7. Select *Calibrate compass* and push the joystick. Follow the on-screen instructions.

Note You must rotate the camera slowly.

13.12 Calibrating the touchscreen LCD

13.12.1 Figure

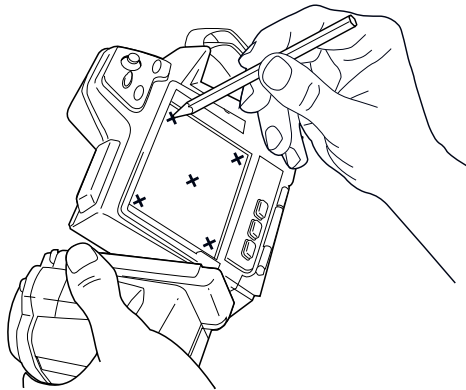

13.12.2 Procedure

Follow this procedure:

1. Push the joystick to display the menu system.
2. Use the joystick to go to  (*Settings*).
3. Push the joystick to display the *Settings* menu.
4. Select *Device settings* and push the joystick.
5. Select *Set up camera* and push the joystick.
6. Select *Calibrate touchscreen* and push the joystick.
7. Calibrate the touchscreen by tapping the five crosshairs that appear on the screen using a stylus pen specially designed for capacitive touch usage.
8. When completed, push the joystick.

13.13 Using the camera lamp as a flash

13.13.1 General

The camera lamp can be used as a flash for the digital camera. When the flash function is activated, the camera lamp will flash when an image is saved by pushing the Auto-focus/Save button fully down.

13.13.2 Procedure

Follow this procedure:

1. Push the joystick to display the menu system.

2. Use the joystick to go to  (*Settings*).
3. Push the joystick to display the *Settings* menu.
4. Select *Device settings* and push the joystick.
5. Select *Set up camera* and push the joystick.
6. Select *Lamp & laser* and push the joystick.
7. Select *Enable lamp & laser*. If the check box is unchecked, push the joystick to enable the camera lamp.
8. Select *Use lamp as flash*. If the check box is unchecked, push the joystick to activate the flash function.

14.1 Saving an image

14.1.1 General

You can save images to a memory card.

The camera saves an image file including all thermal and visual information. This means that you can open an image file at a later stage and, for example, select another image mode, apply color alarms, and add measurement tools.

The image jpg file is fully radiometric and saved lossless, which enables full post-processing in FLIR Tools. There is also a regular jpg part (lossy) for convenient viewing in non-FLIR Systems software (Explorer).

14.1.2 About UltraMax

UltraMax is an image enhancement feature that increases the image resolution and lowers the noise, making small objects easier to see and measure. An UltraMax image is twice as wide and high as an ordinary image.

When an UltraMax image is captured by the camera, several ordinary images are saved in the same file. Capturing all the images can take up to 1 second. To fully utilize UltraMax, the images need to be slightly different, which can be accomplished by a slight movement of the camera. You should hold the camera firmly in your hands (do not put it on a tripod), which will make these images vary just a little during the capture. Correct focus, a high-contrast scene, and a non-moving target are other conditions that help to achieve a good-quality UltraMax image.

At the moment, only FLIR Tools has the ability to process UltraMax images. Other FLIR software will treat the image as a regular image.

14.1.3 Image capacity

The capacity of a 4 GB memory card is theoretically 13 000 images (with no annotations).

Note Although a memory card may have a higher capacity than 5000 images, saving more than that number of images severely slows down file management on the memory card.

14.1.4 Naming convention



The naming convention for image files is FLIRxxxx.jpg, where xxxx is a unique counter.

14.1.5 Procedure

Follow this procedure:

1. To save an image, push the Autofocus/Save button fully down.

Note

- Depending on the settings in  (Settings) > Save options, the following may happen:
 - A preview image is displayed before the image is saved.
 - An annotation tool or the annotation menu is displayed when the image has been saved.
- To configure UltraMax, select  (Settings) > Save options > Image resolution = UltraMax.
- The camera can be configured to also save the visual image as a separate file. Select  (Settings) > Save options > Photo as separate JPEG = On.

14.2 Previewing an image



14.2.1 General

You can preview an image before you save it. This enables you to see if the image contains the information you want before you save it. You can also adjust and edit the image.

Note The camera must be configured to display a preview image before saving. Select  (Settings) > Save options > Preview image before saving = On.

14.2.2 Procedure

Follow this procedure:

1. To preview an image, push the Autofocus/Save button fully down. This displays the preview.
2. Manual image adjust mode is now active, and the status icon  is displayed. For image adjustment instructions, see 14.5 *Adjusting an infrared image*, page 34.
3. To edit the image, push the joystick. This displays a context menu. For editing instructions, see 14.4 *Editing a saved image*, page 33.
4. Do one of the following:
 - To save the image, push the Autofocus/Save button fully down.
 - To exit preview mode without saving, push the Back button .



14.3 Opening a saved image

14.3.1 General

When you save an image, the image file is stored on the memory card. To display the image again, open it from the image archive.

14.3.2 Procedure

Follow this procedure:

1. Push the Image archive button .
2. Move the joystick up/down or left/right to select the image you want to view.
3. Push the joystick. This will display the image at full size.
4. Do one or more of the following:
 - To switch between an infrared image and a visual image, move the joystick up/down.
 - To view the previous/next image, move the joystick left/right.
 - To edit the image, add annotations, display information, or delete the image, push the joystick. This displays a context menu.
 - To return to the image archive overview, push the Back button .

14.4 Editing a saved image







14.4.1 General

You can edit a saved image. You can also edit an image in preview mode.

14.4.2 Procedure

Follow this procedure:

1. Open the image in the image archive.
2. Push the joystick and select  (Edit) from the menu.

-
3. Manual image adjust mode is now active, and the status icon  is displayed. For image adjustment instructions, see 14.5 *Adjusting an infrared image*, page 34.
 4. Push the joystick. This displays a context menu.
 - Select  (*Cancel*) to exit edit mode.
 - Select  (*Measurement parameters*) to change the global parameters.
 - Select  (*Image mode*) to change the image mode.
 - Select  (*Measurement*) to add a measurement tool.
 - Select  (*Color*) to change the color palette or set a color alarm.
 - Select  (*Save*) to save and exit edit mode.

14.5 Adjusting an infrared image

14.5.1 General

An infrared image can be adjusted automatically or manually. When manual image adjust mode is active, the status icon  is displayed.

- In live mode, push the button  to switch between automatic and manual image adjust modes. You can also switch between the modes by touching the temperature scale on the screen.
- In preview/edit mode, manual image adjust mode is active.

14.5.2 Example 1

Here are two infrared images of a building. In the left image, which is auto-adjusted, the large temperature span between the clear sky and the heated building makes a correct analysis difficult. You can analyze the building in more detail if you change the temperature scale to values close to the temperature of the building.

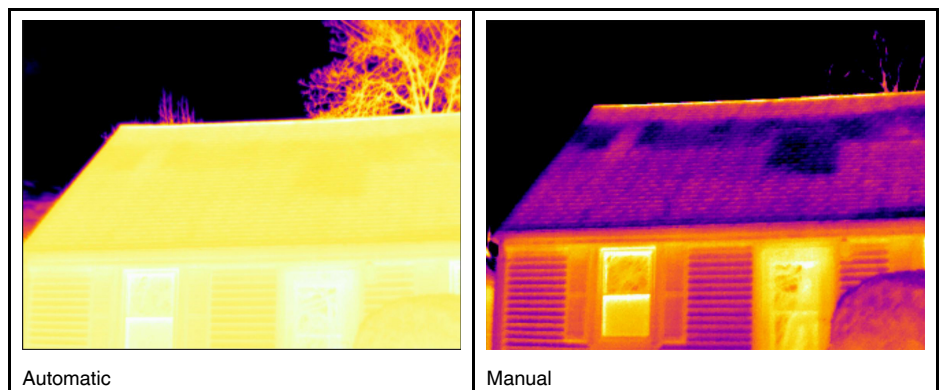

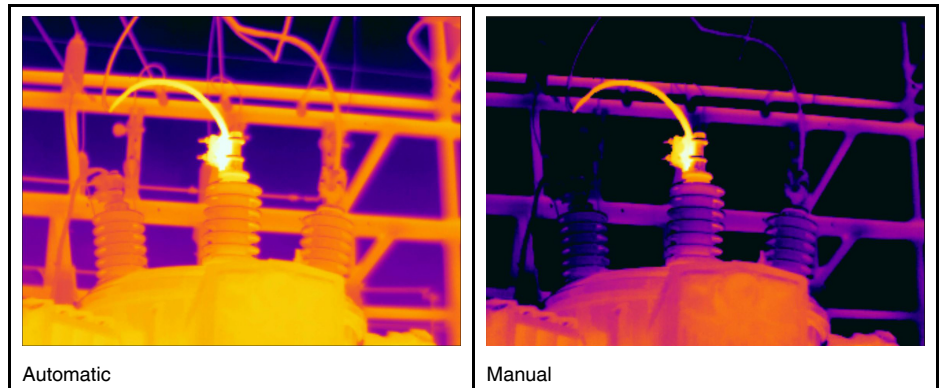

14.5.3 Example 2

Here are two infrared images of an isolator in a power line. To make it easier to analyze the temperature variations in the isolator, the temperature in the right image has been changed to values close to the temperature of the isolator.



14.5.4 Procedure

Follow this procedure:

1. In live mode, push the button  to enter manual image adjust mode.
2. To change the temperature scale minimum and maximum limits simultaneously, move the joystick up/down.
3. To change the temperature scale minimum or maximum limit, do the following:
 - Move the joystick left/right to select (highlight) the maximum or minimum temperature.
 - Move the joystick up/down to change the value of the highlighted temperature.
4. (Optional step). In preview/edit mode, push the button  to perform a one-shot auto-adjust sequence.

14.6 Performing a non-uniformity correction (NUC)

14.6.1 What is a non-uniformity correction?

A non-uniformity correction is *an image correction carried out by the camera software to compensate for different sensitivities of detector elements and other optical and geometrical disturbances*¹.

14.6.2 When to perform a non-uniformity correction?

The non-uniformity correction process should be carried out whenever the output image becomes spatially noisy. The output can become spatially noisy when the ambient temperature changes (such as from day to night operation, and vice versa).

14.6.3 Procedure

To perform a non-uniformity correction, push and hold the Image archive button  for more than 2 seconds.

14.7 Changing the temperature range

14.7.1 General

You must change the temperature range according to the expected temperature of the object you are inspecting.

1. Definition from the impending international adoption of DIN 54190-3 (Non-destructive testing – Thermographic testing – Part 3: Terms and definitions).

14.7.2 Procedure

Follow this procedure:

1. Push the joystick to display the menu system.
2. Use the joystick to go to  (*Settings*).
3. Push the joystick to display the *Settings* menu.
4. Select *Device settings* and push the joystick.
5. Select *Set up camera* and push the joystick.
6. Select *Camera temperature range* and push the joystick.
7. Select the appropriate temperature range and push the joystick.

Note You can also assign the function *Switch temperature range* to the programmable button. Select  (*Settings*) > *Programmable button* > *Switch temperature range*.

14.8 Hiding overlay graphics (programmable button)

14.8.1 General

Overlay graphics provide information about an image, e.g., measurement functions and parameters. You can choose to hide all overlay graphics.

14.8.2 Procedure

Follow this procedure:

1. Push the joystick to display the menu system.
2. Use the joystick to go to  (*Settings*).
3. Push the joystick to display the *Settings* menu.
4. Select *Programmable button* and push the joystick.
5. Select *Hide graphics* and push the joystick. You have now assigned this function to the button **P**. This is a programmable button, and you can assign other functions to it.

Note Other functions that can be associated with the programmable button include the following:

- *Hide graphics*
- *Calibrate*
- *Switch Thermal <> Digital camera*
- *Switch Thermal <> Thermal MSX*
- *Switch 1x zoom <> Max zoom*
- *Switch between two latest palettes*
- *Switch temperature range*

14.9 Changing the color palette

14.9.1 General

You can change the color palette that the camera uses to display different temperatures. A different palette can make it easier to analyze an image.

14.9.2 Procedure

Follow this procedure:

1. Push the joystick to display the menu system.
2. Use the joystick to go to  (*Color*).
3. Push the joystick to display a submenu.
4. Use the joystick to select a different palette.

5. Push the joystick.



14.10 Deleting an image

14.10.1 General

You can delete an image from the memory card.

14.10.2 Procedure

Follow this procedure:

1. Push the Image archive button .
2. Move the joystick up/down or left/right to select the image you want to delete.
3. Push the joystick to display the image.
4. Push the joystick to display a menu.
5. On the menu, select  (*Delete*).
6. Push the joystick and confirm the choice.

Note Note that both images in the image file (thermal and visual) will be deleted.

14.11 Deleting all images

14.11.1 General

You can delete all images from the memory card.

14.11.2 Procedure

Follow this procedure:

1. Push the joystick to display the menu system.
2. Use the joystick to go to  (*Settings*).
3. Push the joystick to display the *Settings* menu.
4. Select *Reset options* and push the joystick.
5. Select *Delete all saved images...* and confirm the choice.

14.12 Creating a PDF report in the camera

14.12.1 General



You can create a PDF report and save it to the memory card. You can then transfer the PDF report to a computer, iPhone, or iPad using FLIR Tools, and send the report to a customer.

14.12.2 Naming convention

The naming convention for report files is REPORTxxxx.jpg, where xxxx is a unique counter.

14.12.3 Procedure

Follow this procedure:

1. Push the Image archive button .
2. Move the joystick up/down or left/right to select an image.
3. Push the joystick to display the image.
4. Push the joystick to display a context menu.
5. Select  (*Information & reports*) and push the joystick. This displays information about the image.

6. Select *Create report* and push the joystick.
The created report will be available in the archive.

15.1 General

The camera captures both thermal and visual images at the same time. By your choice of image mode, you select which type of image to display on the screen.

The camera supports the following image modes:

- *Thermal MSX* (Multi Spectral Dynamic Imaging): The camera displays infrared images where the edges of the objects are enhanced with visual image details.
- *Thermal*: A full infrared image is displayed.
- *Picture in picture*: An infrared image frame is displayed on top of the visual image.
- *Digital camera*: The visual image captured by the digital camera is displayed.

Note

- These image modes only work correctly for calibrated lenses. The lens that ships with the camera is factory calibrated. To have a new lens calibrated, you must send in the camera and the lens to your local service department.
- All thermal and visual information is stored when an image is saved. This means that you can edit the image later, in the image archive or in FLIR Tools, and select any of the image modes.

15.2 Image examples

This table explains the different types of image modes.



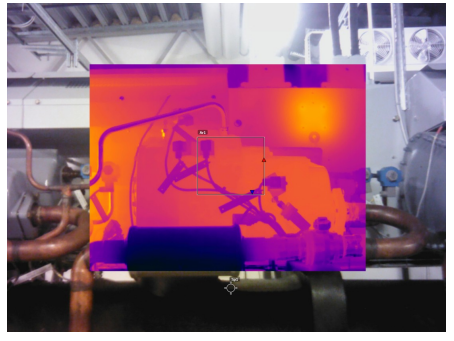
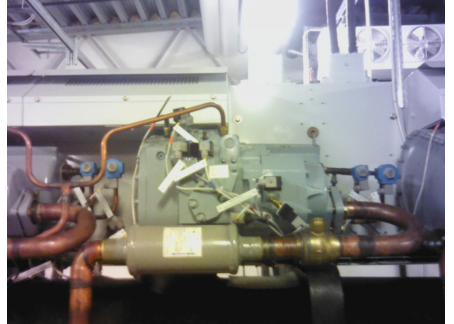





Image mode	Image
<i>Thermal</i>	
<i>Thermal MSX</i>	

Image mode	Image
<i>Picture in picture</i>	
<i>Digital camera</i>	

15.3 Selecting the image mode

Follow this procedure:







1. Push the joystick to display the menu system.
2. Use the joystick to go to  (*Image mode*).
3. Push the joystick to display a submenu.
4. Use the joystick to go to one of the image modes:
 -  (*Thermal MSX*)
 -  (*Thermal*)
 -  (*Picture in picture*)
 -  (*Digital camera*)
5. Push the joystick confirm.
6. If *Picture in picture* mode is selected, you can at this point move and resize the image frame using the touch screen.

16.1 General

To measure a temperature, you can use one or more measurement tools, e.g., a spot-meter or a box.

16.2 Adding/removing measurement tools

Follow this procedure:

1. Push the joystick to display the menu system.
2. Use the joystick to go to  (*Measurement*).
3. Push the joystick to display a submenu.
 - Select  (*No measurements*) to remove all tools.
 - Select  (*Center spot*) to add a center spot.
 - Select  (*Hot spot*) to add a hot spot detection within a box area.
 - Select  (*Cold spot*) to add a cold spot detection within a box area.
 - Select  (*User preset 1*) to add user preset 1. (Not available in all camera models.)
 - Select  (*User preset 2*) to add user preset 2. (Not available in all camera models.)
4. Push the joystick. This displays the measurement tool or the group of preset tools on the screen.







16.3 Working with user presets



16.3.1 General

A user preset is a measurement tool, or a group of measurement tools, with predefined characteristics.

16.3.2 Procedure

Follow this procedure:

1. Push the joystick to display the menu system.
2. Use the joystick to go to  (*Settings*).
3. Push the joystick to display the *Settings* menu.
4. Select *Define user presets* and push the joystick.
5. Select *Define preset 1* or *Define preset 2* and push the joystick. This displays a context menu.
6. Select  (*Add measurement*).
7. Push the joystick. This displays a submenu.
 - Select  (*Add spot*) to add a spot.
 - Select  (*Add box*) to add a box.
 - Select  (*Add circle*) to add a circle.
 - Select  (*Add line*) to add a line.
 - Select  (*Add delta*) to set up a differential calculation.

-
8. Push the joystick. This displays the measurement tool on the screen.
 9. Push the joystick. This displays a context menu, where you can select one or more of the following actions (depending on the type of tool):
 - Remove the tool.
 - Resize, move, center, and rotate the tool.
 - Display maximum, minimum, and average values.
 - Set alarms.
 - Set local parameters.
 - When completed, select  (*Done*).
 10. When all measurement tools have been added, select  (*Save as preset*).

16.4 Resizing or moving a measurement tool

16.4.1 General

You can resize and move a measurement tool.

16.4.2 Procedure

Note

- This procedure assumes that you have previously laid out a measurement tool or user preset on the screen.
- You can also move and resize the measurement tool by touching the screen.

Follow this procedure:



1. To select the measurement tool, touch the tool on the screen. The tool is now displayed with one or more handles.

Spot measurement tool:

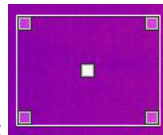

Area measurement tool:



2. Push the joystick—or touch and hold the tool. This displays a context menu.
 - Select  (*Resize*) to change the size of the tool.
 - Select  (*Move*) to move the tool.
3. Move the joystick up/down and left/right to resize or move the tool.
4. When completed, push the joystick and select  (*Done*).

16.5 Changing object parameters

16.5.1 General

For accurate measurements, you must set the object parameters.

16.5.2 Types of parameters

The camera can use these object parameters:

- *External IR window compensation*, i.e., the temperature of any protective windows, external lenses (e.g., the close-up lens), etc., that are set up between the camera and the object of interest. If no protective window, protective shield, or external lens is used, this value is irrelevant and should be left inactive.
- *Object distance*, i.e., the distance between the camera and the object of interest.

- *Atmospheric temperature*, i.e., the temperature of the air between the camera and the object of interest.
- *Relative humidity*, i.e., the relative humidity of the air between the camera and the object of interest.
- *Reflected temperature*, which is used when compensating for the radiation from the surroundings reflected by the object into the camera. This property of the object is called “reflectivity”.
- *Emissivity*, i.e., how much radiation an object emits, compared with the radiation of a theoretical reference object at the same temperature (called a “blackbody”). The opposite of emissivity is reflectivity. The emissivity determines how much of the radiation originates from the object as opposed to being reflected by it.

Note There is an *Emissivity mode* setting, which you can use to enter the emissivity by material instead of by value. Select  (*Settings*) > *Device settings* > *Set up camera* > *Emissivity mode* > *Select from materials table*.

Of the object parameters, *Emissivity* is the most important parameter to set correctly. If the *Emissivity* is set to a low value, the *Reflected temperature* also becomes important. The parameters *Object distance*, *Atmospheric temperature*, and *Relative humidity* are relevant for longer distances. The *External IR window compensation* must be activated if a protective window or external lens is used.

16.5.3 Recommended values

If you are unsure about the values, the following are recommended:

Object distance	1.0 m (3.3')
Atmospheric temperature	20°C (69°F)
Relative humidity	50%
Reflected temperature	20°C (69°F)
Emissivity	0.95

16.5.4 Procedure

You can set the object parameters globally. You can also change the *Emissivity*, *Reflected temperature*, and *Object distance* parameters locally for a measurement tool.

Local parameters are normally only effective for a fixed setup, where each measurement tool is set to a specific object of interest. In a general handheld application, the global parameters are usually sufficient.







Note Of the object parameters, *Emissivity* and *Reflected temperature* are the two most important to set correctly in the camera.

16.5.4.1 Setting global parameters

Follow this procedure:

1. Push the joystick to display the menu system.
2. Use the joystick to go to  (*Measurement parameters*).

3. Push the joystick to display a submenu. Use the joystick to select one or more of the global object parameters:

-  (External IR window compensation)
-  (Object distance)
-  (Atmospheric temperature)
-  (Relative humidity)
-  (Reflected temperature)
-  (Emissivity)





4. Push the joystick to display a dialog box.
5. Use the joystick to change the parameter.
6. Push the joystick. This closes the dialog box.

16.5.4.2 Changing local parameters

You can change the local parameters for a measurement tool.

A *P* next to the measurement tool on the screen indicates that local parameters are activated for the tool.

Follow this procedure:

1. To select the measurement tool, touch the tool on the screen. The tool is now displayed with one or more handles.
2. Push the joystick—or touch and hold the tool. This displays a context menu.
3. Use the joystick to go to  (Use local parameters).
4. Push the joystick.  (icon with grey indicator) is displayed.
5. Push the joystick to activate the use of local parameters.  (icon with blue indicator) is displayed together with a submenu.
6. Use the joystick to select an object parameter.
7. Push the joystick to display a dialog box.
8. Use the joystick to change the parameter.
9. Push the joystick. This closes the dialog box.
10. When completed, push the joystick and select  (*Done*).

16.5.5 Related topics

For in-depth information about parameters, and how to correctly set the emissivity and reflected apparent temperature, see section 32 *Thermographic measurement techniques*, page 235.

16.6 Displaying values in the result table and displaying a graph











16.6.1 General

For the box, circle, and line tools, you can set the camera to display the maximum, minimum, and average values in the result table.

For the line tool, you can also display a graph.

16.6.2 Procedure

Follow this procedure:

1. To select the measurement tool, touch the tool on the screen. The tool is now displayed with one or more handles.
2. Push the joystick—or touch and hold the tool. This displays a context menu.
3. Use the joystick to go to (depending on the tool) , , or  (*Max/Min/Avg/Alarm*) or (*Graph/Max/Min/Avg/Alarm*).
4. Push the joystick. This displays a submenu.
 - (Option available for the line tool.) Select  (*Graph*) and push the joystick to display a graph.
 - Select  (*Max*) and push the joystick to display the maximum value.
 - Select  (*Min*) and push the joystick to display the minimum value.
 - Select  (*Avg*) and push the joystick to display the average value.
 - (Optional step.) You can choose to show or hide the maximum and minimum markers (the hot/cold spots). Select  (*Max & min markers*) and push the joystick to toggle:
 - When  (icon with grey indicator) is displayed, the markers are hidden.
 - When  (icon with blue indicator) is displayed, the markers are shown.
5. When completed, move the joystick down to close the submenu.
6. Select  (*Done*) and push the joystick.

16.7 Creating and setting up a difference calculation

16.7.1 General

A difference calculation gives the difference between the values of two known measurement results.

16.7.2 Procedure

Note

- You can set up a difference calculation when defining user presets, or when editing an image in the archive.
- This procedure assumes that you have previously laid out at least one measurement tool on the screen.

16.7.2.1 Procedure

Follow this procedure:

1. To set up a difference calculation, select  (*Add delta*).

2. Push the joystick. This displays a dialog box where you can select the measurement tools that you want to use in the difference calculation. You can also select a fixed-temperature reference.



3. Push the joystick. The result of the difference calculation is now displayed on the screen.

16.8 Setting a measurement alarm

16.8.1 General

You can make the camera trigger an alarm when certain measurement conditions are met.



16.8.2 Types of alarm

You can choose between the following alarm types:

- *Above*: Triggers an alarm when the temperature is above the preset alarm temperature.
- *Below*: Triggers an alarm when the temperature is below the preset alarm temperature.

16.8.3 Alarm signals

When an alarm is set, the symbol  is displayed in the result table.

When an alarm is triggered, the value in the result table is displayed in red (above alarm) or blue (below alarm) and the symbol  (above alarm) or  (below alarm) is blinking. You can also set an audible alarm (there will be a “beep” when the alarm is triggered).

16.8.4 Procedure

There are different procedures for setting up an alarm for a spot, box, circle, or line and for a difference calculation.

16.8.4.1 Setting up an alarm for a spot

Follow this procedure:





1. To select the spot, touch the tool on the screen. The tool is now displayed with a frame.
2. Push the joystick—or touch and hold the tool. This displays a context menu.
3. Use the joystick to go to  (*Set alarm on spot*).

-
4. Push the joystick. This displays a dialog box where you can define the settings for the alarm.
 - *Alarm condition*: The condition that triggers the alarm. Applicable values are *Above*, *Below*, or *Off*.
 - *Alarm limit*: The temperature value that will be the critical condition when an alarm is triggered or not.
 - *Alarm sound*: Applicable values are *Beep* or *No sound*.
 5. Push the joystick. This closes the dialog box.
 6. Push the joystick and select  (*Done*).

16.8.4.2 Setting up an alarm for a box, circle, or line

Note This procedure assumes that you have previously set the camera to display at least one value (maximum, minimum, or average) in the result table.

Follow this procedure:



1. To select the measurement tool, touch the tool on the screen. The tool is now displayed with one or more handles.
2. Push the joystick—or touch and hold the tool. This displays a context menu.
3. Use the joystick to go to (depending on tool) , , or  (*Max/Min/Avg/Alarm*) or (*Graph/Max/Min/Avg/Alarm*).
4. Push the joystick. This displays a submenu.
5. Select  (*Set alarm*).
6. Push the joystick. This displays a dialog box where you can define the settings for the alarm.
 - *Alarm condition*: The condition that triggers the alarm. Applicable values are *Above*, *Below*, or *Off*.
 - *Select measurement*: Applicable settings are the values you have previously defined (*Max*, *Min*, and/or *Avg*).
 - *Alarm limit*: The temperature value that will be the critical condition when an alarm is triggered or not.
 - *Alarm sound*: Applicable values are *Beep* or *No sound*.
7. Push the joystick. This closes the dialog box.
8. Push the joystick and select  (*Done*).

16.8.4.3 Setting up an alarm for a difference calculation

Note

- You can set up an alarm for a difference calculation when defining user presets, or when editing an image in the archive.
- This procedure assumes that you have previously set up a difference calculation.

Follow this procedure:

1. Select  (*Add measurement*). This displays a submenu.
2. Select  (*Select*). This displays a dialog box.
3. Select *Delta*. This displays a context menu.
4. Use the joystick to go to  (*Set alarm on delta*).
5. Push the joystick. This displays a dialog box where you can define the settings for the alarm.
 - *Alarm condition*: The condition that triggers the alarm. Applicable values are *Above*, *Below*, or *Off*.
 - *Alarm limit*: The temperature value that will be the critical condition when an alarm is triggered or not.
 - *Alarm sound*: Applicable values are *Beep* or *No sound*.

6. Push the joystick. This closes the dialog box.

Fetching data from external FLIR meters

17.1 General

You can fetch data from an external FLIR meter and merge this data into the infrared image.

When the camera is connected to a FLIR meter via Bluetooth, the measurement value from the meter is displayed in the result table of the camera. The FLIR meter value is also added to the information saved in the image file. In preview mode and when editing an image in the archive, you can add more than one value from the same FLIR meter.

Note

- Before you can use a FLIR meter with the camera, you need to pair the devices. For more information, see 11 *Pairing Bluetooth devices*, page 20.
- To add more than one FLIR meter value when saving an image, preview mode must be enabled. Select  (*Settings*) > *Save options* > *Preview image before saving = On*.

In preview mode and when editing an image in the archive, you can do the following:

- Push the programmable button **P** to add the value currently displayed by the FLIR meter.
- Push and hold the programmable button **P** to remove all FLIR meter values from the image.

Note Any function assigned to the programmable button is temporarily disabled when in preview mode or when editing an image in the archive.

17.2 Supported FLIR meters

- FLIR CM78
- FLIR CM83
- FLIR DM93
- FLIR MR77

17.3 Technical support for external meters

Technical support	
Website	http://support.flir.com
E-mail	TMSupport@flir.com
Phone	855-499-3662
Repairs	repair@flir.com

17.4 Typical moisture measurement and documentation procedure

17.4.1 General

The following procedure can form the basis for other procedures using FLIR meters and infrared cameras.

17.4.2 Procedure

Follow this procedure:

1. Use the infrared camera to identify any potential damp areas behind walls and ceilings.
2. Use the moisture meter to measure the moisture levels at various suspect locations that may have been found.

3. When an area of particular interest is located, store the moisture reading in the moisture meter's memory and identify the measurement area with a handprint or other thermal identifying marker.
4. Recall the reading from the meter memory. The moisture meter will now continuously transmit this reading to the infrared camera.
5. Use the camera to take a thermal image of the area with the identifying marker. The stored data from the moisture meter will also be saved on the image.

17.5 More information

For more information, see the users' manuals that are shipped with the FLIR meters.

Working with color alarms and isotherms

18.1 Color alarms

18.1.1 General

By using color alarms (isotherms), anomalies can easily be discovered in an infrared image. The isotherm command applies a contrasting color to all pixels with a temperature above, below, or between the set temperature levels. The camera also features isotherm types that are specific to the building trade: condensation and insulation alarms.

You can make the camera trigger the following types of color alarms:

- *Above alarm*: This will apply a contrasting color to all pixels with a temperature above the specified temperature level.
- *Below alarm*: This will apply a contrasting color to all pixels with a temperature below the specified temperature level.
- *Interval alarm*: This will apply a contrasting color to all pixels with a temperature between two specified temperature levels.
- *Condensation alarm*: Triggers when the camera detects a surface where the relative humidity exceeds a preset value.
- *Insulation alarm*: Triggers when there is an insulation deficiency in a wall.

18.1.2 Image examples



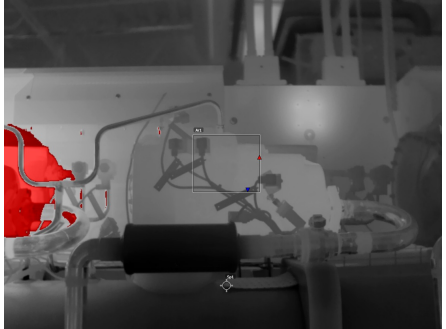
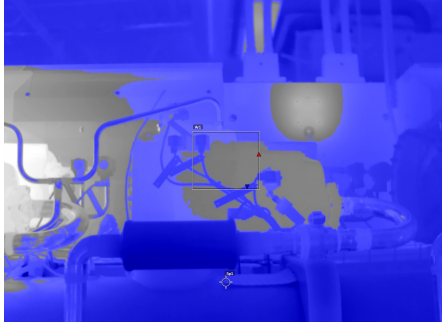

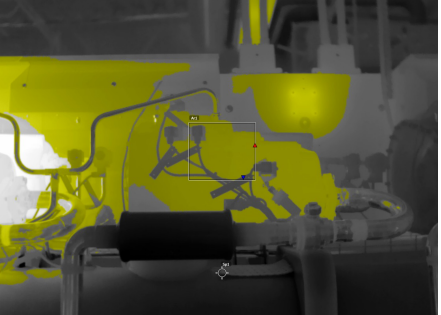
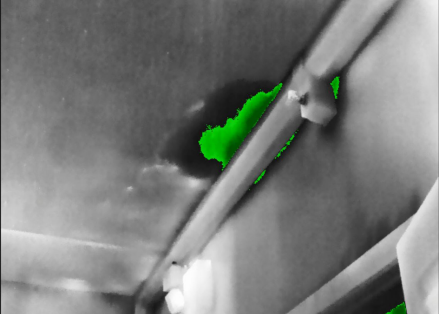
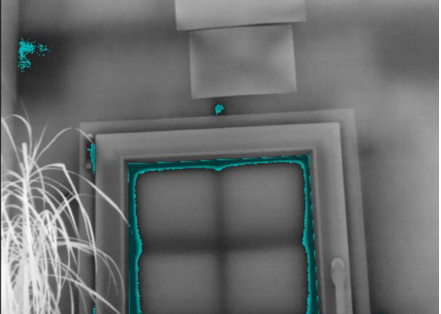
This table explains the different color alarms (isotherms).

Color alarm	Image
<i>Above alarm</i>	
<i>Below alarm</i>	

Color alarm	Image
<i>Interval alarm</i>	
<i>Condensation alarm</i>	
<i>Insulation alarm</i>	

18.2 Setting up above, below, and interval alarms

Follow this procedure:

1. Push the joystick to display the menu system.
2. Use the joystick to go to  (*Color*).
3. Push the joystick to display a submenu. Use the joystick to select the type of alarm:
 -  (*Above alarm*)
 -  (*Below alarm*)
 -  (*Interval alarm*)
4. Push the joystick. The threshold temperature is displayed at the bottom of the screen.
5. To change the threshold temperature, do the following:
 - For the *Interval alarm*, move the joystick left/right to select the low/high-temperature value.
 - Move the joystick up/down to change the threshold temperature.

18.3 Building isotherms

Note The Condensation and Insulation alarms are not supported by all camera models.

18.3.1 About the Condensation alarm

To detect areas with potential moisture problems, you can use the *Condensation alarm*. You can set the relative humidity above which the isotherm will colorize the image.



18.3.2 About the Insulation alarm

The *Insulation alarm* can detect areas where there may be an insulation deficiency in the building. It will trigger when the insulation level (which is called the thermal index in the camera) falls below a preset value of the energy leakage through a wall.

Different building codes recommend different values for the insulation level, but typical values are 60–80% for new buildings. Refer to your national building code for recommendations.

18.3.3 Setting up condensation and insulation alarms

Follow this procedure:

1. Push the joystick to display the menu system.
2. Use the joystick to go to  (*Color*).
3. Push the joystick to display a submenu. Use the joystick to select the type of alarm:
 -  (*Condensation alarm*)
 -  (*Insulation alarm*)
4. Push the joystick. This displays a dialog box where you can define the settings for the alarm.

For the *Condensation alarm*, the following parameters can be set:

- *Atmospheric temperature*: The current atmospheric temperature.
- *Relative humidity*: The current relative humidity.
- *Relative humidity limit*: The relative humidity level at which you want the alarm to be triggered. A relative humidity of 100% means that water vapor condenses from the air as liquid water (= dewpoint). A relative humidity of about 70% or above can cause mold.

For the *Insulation alarm*, the following parameters can be set:

- *Indoor temperature*: The current indoor temperature.
- *Outdoor temperature*: The current outdoor temperature.
- *Thermal index*: The insulation level, an integer between 0 and 100.

5. Push the joystick. This closes the dialog box.

19.1 General

You can save additional information together with an infrared image by using annotations. Annotations make reporting and post-processing more efficient, by providing essential information about the image, e.g., conditions and information about where an image is taken.

Annotations are added to the image file, and can be viewed and edited in the image archive, and also when moving files from the camera to reporting software on the computer.

- You can set the camera to display annotation tools before an image is saved. Select  (Settings) > Save options > Add annotation after saving.
- You can also add annotations to a saved image in the image archive.

Note This section describes the procedures for adding annotations to a saved image in the image archive. Adding annotations when saving an image works in a similar way.

19.2 Adding a note

19.2.1 General

A text note is grouped with the image file. Using this feature, you can annotate images by entering free-form text.

19.2.2 Procedure

Follow this procedure:

1. Open the image in the image archive.
2. Push the joystick. This displays a context menu.
3. Select  (Add note).
4. Push the joystick. This displays a soft keyboard where you can enter the text you want to save.

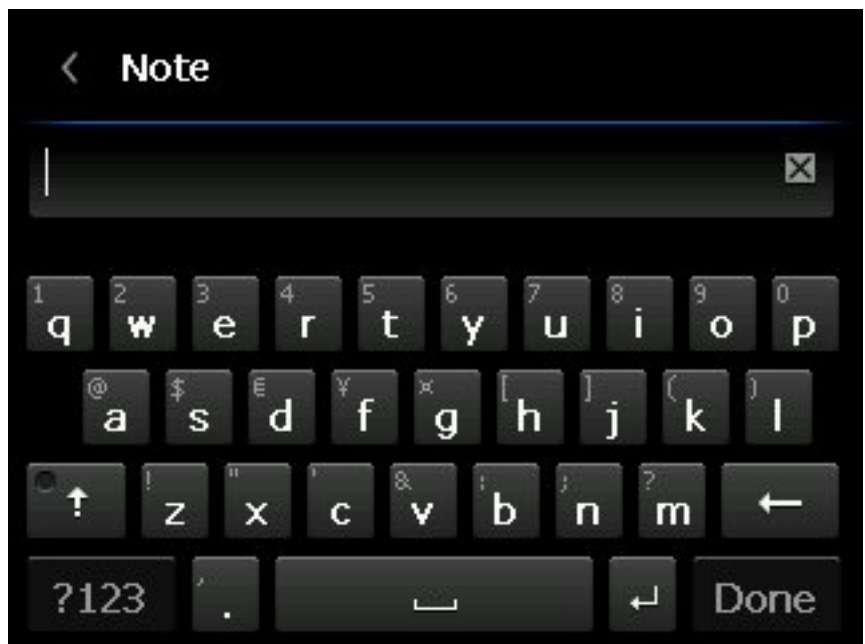

Note To select special characters, press and hold down the corresponding key on the soft keyboard.

5. When completed, touch *Done* on the soft keyboard.

19.3 Adding a table



19.3.1 General

You can save a table with textual information to the image file. This feature is a very efficient way of recording information when you are inspecting a large number of similar objects. The idea behind using a table with textual information is to avoid filling out forms or inspection protocols manually.

The camera has a number of default table templates. You can also import your own table templates from FLIR Tools. The templates are stored on the memory card.

19.3.2 Procedure

Follow this procedure:

1. Open the image in the image archive.
2. Push the joystick. This displays a context menu.
3. Select  (*Add table*) and push the joystick.
4. Select  (*Add table contents*) and push the joystick.
5. This displays the default table template that ships with the camera.

Note You can select another template by first selecting  (*Select default template*).

6. For each row in the table, do the following:
 - Push the joystick. This displays the predefined values.
 - Move the joystick up/down to select a predefined value. Push the joystick to confirm.
 - Instead of selecting a predefined value, you can select the keyboard  and enter other text.
7. When completed, select *Save & Exit* at the bottom of the table. Push the joystick to confirm.

19.4 Adding a voice annotation







19.4.1 General

A voice annotation is an audio recording that is saved to the infrared image file.

The voice annotation is recorded using a Bluetooth headset. The recording can be played back in the camera, and in image analysis and reporting software from FLIR Systems.

19.4.2 Procedure

Follow this procedure:

1. Open the image in the image archive.
2. Push the joystick. This displays a context menu.
3. Select  (*Add voice annotation*) and push the joystick.
4. To start a recording, select  (*Record*) and push the joystick.
5. To stop the recording, select  (*Stop*) and push the joystick.
6. To listen to the recording, select  (*Play*) and push the joystick.
7. To delete the recording, select  (*Delete*) and push the joystick.
8. When completed, select  (*Done*) and push the joystick.







19.5 Adding a sketch

19.5.1 General

You can add a freehand drawing to an image.

19.5.2 Procedure

Follow this procedure:

1. Open the image in the image archive.
2. Push the joystick. This displays a context menu.
3. Select  (*Add sketch*) and push the joystick.
4. You are now in sketch mode. Draw the sketch by touching the screen.
5. Push the joystick. This displays a context menu. Do one or more of the following:
 - To change the color of the sketch tools, select  (*Draw*) and push the joystick. Select the color and push the joystick.
 - To erase, select  (*Eraser*) and push the joystick. Erase parts of the sketch by touching the screen.
 - To add an arrow, circle, or cross, select  (*Stamp sketch*) and push the joystick. Select the type of stamp and push the joystick. The stamp is displayed in the center of the screen. You can move the stamp by touching the screen.
 - To clear, select  (*Clear all*) and push the joystick.
 - When the sketch is completed, select  (*Save*) and push the joystick.



Programming the camera (time lapse)

20.1 General

You can program the camera to save images periodically (time lapse).

20.2 Procedure

Follow this procedure:

1. Push the joystick to display the menu system.
2. Use the joystick to go to  (*Recording mode*).
3. Push the joystick. This displays a submenu.
4. Select  (*Time lapse*).
5. Push the joystick. This displays a dialog box, where you can set the save conditions:
 - *Save interval*: Use the joystick to set the time interval between each saved image.
 - *Total number of images*: Periodic saving will stop when the set number of images have been saved.
6. Push the joystick. This closes the dialog box. The time interval is displayed at the top of the screen.
7. To manually start or stop periodic saving, briefly push and release the Autofocus/ Save button.

21.1 General



You can record and save video clips to the memory card.

Note The camera can be configured to save video in *.mpg or *.csq format. Select  (Settings) > Save options > Video compression.

- *Mpeg (*.mpg)*: Mpeg recordings cannot be edited after the file has been saved.
- *Radiometric storage (*.csq)*: A *.csq file supports full radiometry but is only supported by FLIR Systems software. The file does not include any visual-image information.

21.2 Procedure

Follow this procedure:

1. Push the joystick to display the menu system.
2. Use the joystick to go to  (Recording mode).
3. Push the joystick. This displays a submenu.
4. Select  (Video) and push the joystick.
5. Do the following:
 - To start a recording, push and release the Autofocus/Save button. A counter at the top of the screen displays the duration of the recording.
 - To stop a recording, push and release the Autofocus/Save button.
6. The recording is automatically saved to the image archive, where you can play or delete it.

22.1 General

The screening alarm can be used, for example, at airports to detect passengers with elevated body temperatures, which may indicate the presence of a fever.

Activating the screening alarm will turn on a measurement box and screening data in the result table.

 The sampled average temperature.



 The alarm temperature.

 The measured temperature.

The alarm will trigger when the measurement box measures a temperature higher than the alarm temperature. The alarm temperature is, in turn, the sum of a specified allowed deviation and a sampled average value.

22.2 Procedure

Follow this procedure:

1. Enable the screening mode by selecting  (*Settings*) > *Device settings* > *Set up camera* > *Screening mode = On*.
2. Push the joystick to display the menu system.
3. Use the joystick to go to  (*Recording mode*).
4. Push the joystick. This displays a submenu.
5. Select  (*Screening*).
6. Push the joystick. This displays a dialog box where you can define the settings for the alarm.
 - *Allowed deviation*: The allowed deviation from the sampled average.
 - *Alarm sound*: Applicable values are *Beep* or *No sound*.
7. Push the joystick. This closes the dialog box.
8. Aim the camera toward a point of interest. The object should be within the frame of the measurement box.
9. Push and hold the programmable button **P** to reset the sampled average.
10. Push the programmable button **P** to sample.
11. Aim the camera toward more points of interest. Sample 10 times to build up a sample base by pushing the programmable button **P**.

The alarm is now set up and ready to use. Occasionally record a few samples if the alarm is used for a long time or if the conditions change.

Note

- The algorithm has a memory of the last 10 samples. It discriminates between the highest and lowest values, and calculates an average of the remaining values.
- Do not modify the measurement setup or activate another alarm because this will deactivate the screening alarm.

23.1 General

The *Settings* menu includes the following:

- *Define user presets*
- *Save options*
- *Programmable button*
- *Reset options*
- *Device settings*

23.1.1 Define user presets

- *Define preset 1*
- *Define preset 2*

23.1.2 Save options

- *Preview image before saving*
- *Add annotation after saving*
- *Image resolution*
- *Video compression*
- *Photo as separate JPEG*

23.1.3 Programmable button

- *No action*
- *Hide graphics*
- *Calibrate*
- *Switch Thermal <> Digital camera*
- *Switch Thermal <> Thermal MSX*
- *Switch 1x zoom <> Max zoom*
- *Switch between two latest palettes*
- *Switch temperature range*

23.1.4 Reset options

- *Reset default camera mode...*
- *Reset device settings to factory default...*
- *Delete all saved images...*

Note When an option is selected, a dialog box is displayed with more information. You can choose to execute the reset/delete action or to cancel.



23.1.5 Device settings

- *Set up camera*
 - *Camera temperature range*: The temperature range used for measuring objects. You must change the temperature range according to the expected temperature of the object you are inspecting.
 - *Auto orientation*
 - *Display intensity*
 - *Lamp & laser*
 - *Auto power off*
 - *Emissivity mode*
 - *Video output format*
 - *Calibrate touchscreen*
 - *Screening mode*
- *Wi-Fi*: For more information, see 12 *Configuring Wi-Fi*, page 21.
- *Compass*
- *Bluetooth including METERLiNK*: For more information, see 11 *Pairing Bluetooth devices*, page 20.
- *Language, time & units*

- *Camera information*: Information about the model, serial number, part number, and software versions. No changes can be made.

23.2 Procedure

Follow this procedure:

1. Push the joystick to display the menu system.
2. Use the joystick to go to  (*Settings*).
3. Push the joystick to display the *Settings* menu.
4. Use the joystick to select the setting you want to change.
5. To exit the *Settings* menu or a submenu, push the Back button .

24.1 Online field-of-view calculator

Please visit <http://support.flir.com> and click the photo of the camera series for field-of-view tables for all lens-camera combinations.

24.2 Note about technical data

FLIR Systems reserves the right to change specifications at any time without prior notice. Please check <http://support.flir.com> for latest changes.

24.3 Note about authoritative versions

The authoritative version of this publication is English. In the event of divergences due to translation errors, the English text has precedence.

Any late changes are first implemented in English.

24.4 FLIR T420 (incl. Wi-Fi and 15° lens)

P/N: 62103-1102

Rev.: 35207

General description	
The FLIR T420 is a camera that offers good performance at an affordable price. Excellent ergonomics, a walk-up-and-use interface, and easy communication make the FLIR T420 a truly user-friendly camera for the beginner or advanced user.	
Benefits:	
<ul style="list-style-type: none"> • Excellent ergonomics: The FLIR T420 has a tiltable infrared unit and auto-orientation, which make it easy to capture images from any angle comfortably. The small size and low weight of the camera facilitate its use over a full working day. • Affordable performance: The FLIR T420 is equipped with the innovative Multi Spectral Dynamic Imaging (MSX) feature, which produces an image richer in detail than ever before. You can highlight objects of interest, on both the infrared and the visual images, by sketching or adding predefined stamps directly onto the camera's touch screen. • Extensive communication options: The Wi-Fi connectivity of the FLIR T420 allows you to connect to smart phones or tablets, for the wireless transfer of images or the remote control of the camera. The Bluetooth-based METERLiNK function transfers readings from external measurement instruments to the infrared image. • Support for UltraMax: When enabling UltraMax in the camera, the resolution of images can be substantially enhanced when importing the images into FLIR Tools. 	
Imaging and optical data	
IR resolution	320 × 240 pixels
MSX resolution	320 × 240 pixels
UltraMax	Yes
Thermal sensitivity/NETD	<40 mK @ +30°C (+86°F)
Field of view (FOV)	25° × 19°
Minimum focus distance	0.4 m (1.31 ft.)
Focal length	18 mm (0.7 in.)
Spatial resolution (IFOV)	1.36 mrad
F-number	1.3
Image frequency	60 Hz
Focus	Automatic (one shot) or manual
Digital zoom	2× and 4×
Detector data	
Detector type	Focal plane array (FPA), uncooled microbolometer
Spectral range	7.5–13 μm
Detector pitch	25 μm
Image presentation	
Display	Touch screen, 3.5 in. LCD, 320 × 240 pixels
Auto orientation	Automatic landscape or portrait
Image adjustment	Auto or manual
Image presentation modes	
Thermal MSX	Thermal image with enhanced detail presentation
Picture in Picture	Resizable and movable IR area on visual image

Measurement	
Object temperature range	<ul style="list-style-type: none"> • -20°C to +120°C (-4°F to +248°F) • 0°C to +650°C (+32°F to +1202°F)
Accuracy	±2°C (±3.6°F) or 2%, whichever is greater, at 25°C (77°F) nominal.
Measurement analysis	
Spotmeter	5
Area	5 + 5 areas (boxes or circles) with max./min./average (in post-acquisition analysis)
Automatic hot/cold detection	Auto hot or cold spotmeter markers within area
Measurement presets	No measurements, Center spot, Hot spot, Cold spot, 3 spots, Hotspot-spot, Hotspot-temperature
Difference temperature	Delta temperature between measurement functions or reference temperature
Reference temperature	Manually set using difference temperature
Emissivity correction	Variable from 0.01 to 1.0 or selected from materials list
Measurement corrections	Emissivity, reflected temperature, relative humidity, atmospheric temperature, object distance, external IR window compensation
Colors (palettes)	Iron, Rainbow, Rainbow HC, White hot, Black hot, Arctic, Lava
Alarm	
Color Alarm (isotherm)	Above/below/interval
Measurement function alarm	Audible/visual alarms (above/below) on any selected measurement function
Screening	Difference temperature alarm, audible
Set-up	
Set-up commands	Save options, Programmable button, Reset options, Set up camera, Wi-Fi, Compass, Bluetooth, Language, Time & units, Camera information
Service functions	
Camera software update	Use PC software FLIR Tools
Storage of images	
Image storage	Standard JPEG, including digital photo and measurement data, on memory card
Image storage mode	<ul style="list-style-type: none"> • Simultaneous storage of thermal and digital photo in same JPEG file. • Optional to store digital photo as a separate JPEG file.
Time lapse	15 seconds to 24 hours
Image annotations (in still images)	
Voice	60 seconds (via Bluetooth) stored with the image
Text	Add table. Select between predefined templates or create your own in FLIR Tools
Image description	Add short note (stored in JPEG EXIF tag)

Image annotations (in still images)	
METERLiNK	Wireless connection (Bluetooth) to: FLIR meters with METERLiNK
Report generation	<ul style="list-style-type: none"> Instant Report (*.pdf file) in camera including IR and visual images Separate PC software with extensive report generation
Geographic Information System	
Compass	Camera direction automatically added to every still image
Video recording in camera	
Non-radiometric IR video recording	MPEG-4 to memory card
Visual video recording	MPEG-4 to memory card
Video streaming	
Radiometric IR video streaming	Full dynamic to PC using USB or to mobile devices using Wi-Fi.
Non-radiometric IR video streaming	<ul style="list-style-type: none"> MPEG-4 using Wi-Fi Uncompressed colorized video using USB
Visual video streaming	<ul style="list-style-type: none"> MPEG-4 using Wi-Fi Uncompressed colorized video using USB
Digital camera	
Built-in digital camera	3.1 Mpixels with LED light (photo as separate image)
Digital camera, focus	Fixed focus
Digital camera, FOV	Adapts to the IR lens
Built-in digital lens data	FOV 53° × 41°
Digital camera, aspect ratio	4:3
Laser pointer	
Laser	Activated by dedicated button
Laser alignment	Position is automatic displayed on the IR image
Laser classification	Class 2
Laser type	Semiconductor AlGaInP diode laser
Laser power	1 mW
Laser wavelength	635 nm (red)
Data communication interfaces	
Interfaces	USB-mini, USB-A, Bluetooth, Wi-Fi, composite video
METERLiNK/Bluetooth	Communication with headset and external sensors
Wi-Fi	Peer to peer (ad hoc) or infrastructure (network)
SD Card	One card slot for removable SD memory cards
USB	
USB	<ul style="list-style-type: none"> USB-A: Connect external USB device USB Mini-B: Data transfer to and from PC / uncompressed colorized video
USB, standard	USB Mini-B: 2.0

Composite video	
Video out	Composite
Video, standard	CVBS (ITU-R-BT.470 PAL/SMPTE 170M NTSC)
Video, connector type	4-pole 3.5 mm jack
Radio	
Wi-Fi	<ul style="list-style-type: none"> • Standard: 802.11 b/g • Frequency range: 2412–2462 MHz • Max. output power: 15 dBm
METERLiNK/Bluetooth	Frequency range: 2402–2480 MHz
Antenna	Internal
Power system	
Battery type	Rechargeable Li ion battery
Battery voltage	3.7 V
Battery capacity	4.4 Ah, at +20°C to +25°C (+68°F to +77°F)
Battery operating time	Approx. 4 hours at +25°C (+77°F) ambient temperature and typical use
Charging system	In camera (AC adapter or 12 V from a vehicle) or 2-bay charger
Charging time	4 h to 90% capacity, charging status indicated by LED's
Charging temperature	0°C to +45°C (+32°F to +113°F)
Power management	Automatic shutdown and sleep mode (user selectable)
AC operation	AC adapter, 90–260 VAC input, 12 V output to camera
Start-up time from sleep mode	Instant on
Environmental data	
Operating temperature range	–15°C to +50°C (+5°F to +122°F)
Storage temperature range	–40°C to +70°C (–40°F to +158°F)
Humidity (operating and storage)	IEC 60068-2-30/24 h 95% relative humidity +25°C to +40°C (+77°F to +104°F) / 2 cycles
EMC	<ul style="list-style-type: none"> • ETSI EN 301 489-1 (radio) • ETSI EN 301 489-17 • EN 61000-6-2 (Immunity) • EN 61000-6-3 (Emission) • FCC 47 CFR Part 15 B (Emission) • ICES-003
Radio spectrum	<ul style="list-style-type: none"> • ETSI EN 300 328 • FCC Part 15.247 • RSS-210
Magnetic fields	EN 61 000-4-8, Test level 5 for continuous field (severe industrial environment)
Encapsulation	IP 54 (IEC 60529)
Shock	25 g (IEC 60068-2-27)
Vibration	2 g (IEC 60068-2-6)
Safety	EN/UL/CSA/PSE 60950-1

Physical data	
Camera weight, incl. battery	0.855 kg (1.88 lb.)
Camera size (L x W x H)	106 x 201 x 125 mm (4.2 x 7.9 x 4.9 in.), with built-in lens pointing forward
Tripod mounting	UNC ¼"-20 (adapter needed)
Material	<ul style="list-style-type: none"> Polycarbonate + acrylonitrile butadiene styrene (PC-ABS) Thixomold magnesium Thermoplastic elastomer (TPE)
Color	Graphite gray and black
Shipping information	
Packaging, type	Cardboard box
List of contents	<ul style="list-style-type: none"> Infrared camera with lens Battery (2 ea.) Battery charger Bluetooth headset Camera lens cap Calibration certificate Printed documentation Hard transport case Memory card Neckstrap Power supply, incl. multi-plugs Sunshield USB cable Video cable IR lens, f = 30 mm, 15°
Packaging, weight	5.7 kg (12.6 lb.)
Packaging, size	495 x 192 x 370 mm (19.49 x 7.56 x 14.57 in.)
EAN-13	7332558010525
UPC-12	845188011185
Country of origin	Sweden

Supplies & accessories:

- 1196961; IR lens, f = 30 mm, 15° incl. case
- 1196960; IR lens, f = 10 mm, 45° incl. case
- T197215; Close-up 4x (100 µm) incl. case
- T197214; Close-up 2x (50 µm) incl. case
- T197408; IR lens, 76 mm (6°) with case and mounting support for T/B-200/400
- T197412; IR lens, 4 mm (90°) with case and mounting support for T/B2xx-4xx
- T197000; High temp. option +1200°C (+2192°F)
- T910814; Power supply, incl. multi plugs
- T197650; 2-bay battery charger, incl. power supply with multi plugs
- 1196398ACC; Battery
- T911230ACC; Memory card SDHC 4 GB
- 1910423; USB cable Std A <-> Mini-B
- T198509; Cigarette lighter adapter kit, 12 VDC, 1.2 m/3.9 ft.
- 1910582ACC; Video cable
- T198370ACC; Hard transport case for FLIR T/B2xx-4xx
- T198495; Pouch for FLIR T6xx and T4xx series
- 1124545; Pouch
- T198493; Sun shield
- T198499; Neck strap
- T197771ACC; Bluetooth Headset
- T911093; Tool belt
- 19250-100; IR Window 2 in
- 19251-100; IR Window 3 in.

- 19252-100; IR Window 4 in.
- 19250-200; SS IR Window 2 in.
- 19251-200; SS IR Window 3 in.
- 19252-200; SS IR Window 4 in.
- T198586; FLIR Reporter Professional (license only)
- T198584; FLIR Tools
- T198583; FLIR Tools+ (download card incl. license key)
- DSW-10000; FLIR IR Camera Player
- APP-10002; FLIR Tools Mobile (Android Application)
- APP-10004; FLIR Tools (MacOS Application)
- T198697; FLIR ResearchIR Max + HSDR 4 (hardware sec. dev.)
- T199014; FLIR ResearchIR Max + HSDR 4 (printed license key)
- T199044; FLIR ResearchIR Max + HSDR 4 Upgrade (printed license key)
- T198696; FLIR ResearchIR Max 4 (hardware sec. dev.)
- T199013; FLIR ResearchIR Max 4 (printed license key)
- T199043; FLIR ResearchIR Max 4 Upgrade (printed license key)
- T198731; FLIR ResearchIR Standard 4 (hardware sec. dev.)
- T199012; FLIR ResearchIR Standard 4 (printed license key)
- T199042; FLIR ResearchIR Standard 4 Upgrade (printed license key)
- T199233; FLIR Atlas SDK for .NET
- T199234; FLIR Atlas SDK for MATLAB

24.5 FLIR T420 (incl. Wi-Fi and 45° lens)

P/N: 62103-1103

Rev.: 35207

General description	
The FLIR T420 is a camera that offers good performance at an affordable price. Excellent ergonomics, a walk-up-and-use interface, and easy communication make the FLIR T420 a truly user-friendly camera for the beginner or advanced user.	
Benefits:	
<ul style="list-style-type: none"> • Excellent ergonomics: The FLIR T420 has a tiltable infrared unit and auto-orientation, which make it easy to capture images from any angle comfortably. The small size and low weight of the camera facilitate its use over a full working day. • Affordable performance: The FLIR T420 is equipped with the innovative Multi Spectral Dynamic Imaging (MSX) feature, which produces an image richer in detail than ever before. You can highlight objects of interest, on both the infrared and the visual images, by sketching or adding predefined stamps directly onto the camera's touch screen. • Extensive communication options: The Wi-Fi connectivity of the FLIR T420 allows you to connect to smart phones or tablets, for the wireless transfer of images or the remote control of the camera. The Bluetooth-based METERLiNK function transfers readings from external measurement instruments to the infrared image. • Support for UltraMax: When enabling UltraMax in the camera, the resolution of images can be substantially enhanced when importing the images into FLIR Tools. 	
Imaging and optical data	
IR resolution	320 × 240 pixels
MSX resolution	320 × 240 pixels
UltraMax	Yes
Thermal sensitivity/NETD	<40 mK @ +30°C (+86°F)
Field of view (FOV)	25° × 19°
Minimum focus distance	0.4 m (1.31 ft.)
Focal length	18 mm (0.7 in.)
Spatial resolution (IFOV)	1.36 mrad
F-number	1.3
Image frequency	60 Hz
Focus	Automatic (one shot) or manual
Digital zoom	2× and 4×
Detector data	
Detector type	Focal plane array (FPA), uncooled microbolometer
Spectral range	7.5–13 μm
Detector pitch	25 μm
Image presentation	
Display	Touch screen, 3.5 in. LCD, 320 × 240 pixels
Auto orientation	Automatic landscape or portrait
Image adjustment	Auto or manual
Image presentation modes	
Thermal MSX	Thermal image with enhanced detail presentation
Picture in Picture	Resizable and movable IR area on visual image

Measurement	
Object temperature range	<ul style="list-style-type: none"> • -20°C to +120°C (-4°F to +248°F) • 0°C to +650°C (+32°F to +1202°F)
Accuracy	±2°C (±3.6°F) or 2%, whichever is greater, at 25°C (77°F) nominal.
Measurement analysis	
Spotmeter	5
Area	5 + 5 areas (boxes or circles) with max./min./average (in post-acquisition analysis)
Automatic hot/cold detection	Auto hot or cold spotmeter markers within area
Measurement presets	No measurements, Center spot, Hot spot, Cold spot, 3 spots, Hotspot-spot, Hotspot-temperature
Difference temperature	Delta temperature between measurement functions or reference temperature
Reference temperature	Manually set using difference temperature
Emissivity correction	Variable from 0.01 to 1.0 or selected from materials list
Measurement corrections	Emissivity, reflected temperature, relative humidity, atmospheric temperature, object distance, external IR window compensation
Colors (palettes)	Iron, Rainbow, Rainbow HC, White hot, Black hot, Arctic, Lava
Alarm	
Color Alarm (isotherm)	Above/below/interval
Measurement function alarm	Audible/visual alarms (above/below) on any selected measurement function
Screening	Difference temperature alarm, audible
Set-up	
Set-up commands	Save options, Programmable button, Reset options, Set up camera, Wi-Fi, Compass, Bluetooth, Language, Time & units, Camera information
Service functions	
Camera software update	Use PC software FLIR Tools
Storage of images	
Image storage	Standard JPEG, including digital photo and measurement data, on memory card
Image storage mode	<ul style="list-style-type: none"> • Simultaneous storage of thermal and digital photo in same JPEG file. • Optional to store digital photo as a separate JPEG file.
Time lapse	15 seconds to 24 hours
Image annotations (in still images)	
Voice	60 seconds (via Bluetooth) stored with the image
Text	Add table. Select between predefined templates or create your own in FLIR Tools
Image description	Add short note (stored in JPEG EXIF tag)

Image annotations (in still images)	
METERLiNK	Wireless connection (Bluetooth) to: FLIR meters with METERLiNK
Report generation	<ul style="list-style-type: none"> Instant Report (*.pdf file) in camera including IR and visual images Separate PC software with extensive report generation
Geographic Information System	
Compass	Camera direction automatically added to every still image
Video recording in camera	
Non-radiometric IR video recording	MPEG-4 to memory card
Visual video recording	MPEG-4 to memory card
Video streaming	
Radiometric IR video streaming	Full dynamic to PC using USB or to mobile devices using Wi-Fi.
Non-radiometric IR video streaming	<ul style="list-style-type: none"> MPEG-4 using Wi-Fi Uncompressed colorized video using USB
Visual video streaming	<ul style="list-style-type: none"> MPEG-4 using Wi-Fi Uncompressed colorized video using USB
Digital camera	
Built-in digital camera	3.1 Mpixels with LED light (photo as separate image)
Digital camera, focus	Fixed focus
Digital camera, FOV	Adapts to the IR lens
Built-in digital lens data	FOV 53° × 41°
Digital camera, aspect ratio	4:3
Laser pointer	
Laser	Activated by dedicated button
Laser alignment	Position is automatic displayed on the IR image
Laser classification	Class 2
Laser type	Semiconductor AlGaInP diode laser
Laser power	1 mW
Laser wavelength	635 nm (red)
Data communication interfaces	
Interfaces	USB-mini, USB-A, Bluetooth, Wi-Fi, composite video
METERLiNK/Bluetooth	Communication with headset and external sensors
Wi-Fi	Peer to peer (ad hoc) or infrastructure (network)
SD Card	One card slot for removable SD memory cards
USB	
USB	<ul style="list-style-type: none"> USB-A: Connect external USB device USB Mini-B: Data transfer to and from PC / uncompressed colorized video
USB, standard	USB Mini-B: 2.0

Composite video	
Video out	Composite
Video, standard	CVBS (ITU-R-BT.470 PAL/SMPTE 170M NTSC)
Video, connector type	4-pole 3.5 mm jack
Radio	
Wi-Fi	<ul style="list-style-type: none"> • Standard: 802.11 b/g • Frequency range: 2412–2462 MHz • Max. output power: 15 dBm
METERLiNK/Bluetooth	Frequency range: 2402–2480 MHz
Antenna	Internal
Power system	
Battery type	Rechargeable Li ion battery
Battery voltage	3.7 V
Battery capacity	4.4 Ah, at +20°C to +25°C (+68°F to +77°F)
Battery operating time	Approx. 4 hours at +25°C (+77°F) ambient temperature and typical use
Charging system	In camera (AC adapter or 12 V from a vehicle) or 2-bay charger
Charging time	4 h to 90% capacity, charging status indicated by LED's
Charging temperature	0°C to +45°C (+32°F to +113°F)
Power management	Automatic shutdown and sleep mode (user selectable)
AC operation	AC adapter, 90–260 VAC input, 12 V output to camera
Start-up time from sleep mode	Instant on
Environmental data	
Operating temperature range	–15°C to +50°C (+5°F to +122°F)
Storage temperature range	–40°C to +70°C (–40°F to +158°F)
Humidity (operating and storage)	IEC 60068-2-30/24 h 95% relative humidity +25°C to +40°C (+77°F to +104°F) / 2 cycles
EMC	<ul style="list-style-type: none"> • ETSI EN 301 489-1 (radio) • ETSI EN 301 489-17 • EN 61000-6-2 (Immunity) • EN 61000-6-3 (Emission) • FCC 47 CFR Part 15 B (Emission) • ICES-003
Radio spectrum	<ul style="list-style-type: none"> • ETSI EN 300 328 • FCC Part 15.247 • RSS-210
Magnetic fields	EN 61 000-4-8, Test level 5 for continuous field (severe industrial environment)
Encapsulation	IP 54 (IEC 60529)
Shock	25 g (IEC 60068-2-27)
Vibration	2 g (IEC 60068-2-6)
Safety	EN/UL/CSA/PSE 60950-1

Physical data	
Camera weight, incl. battery	0.855 kg (1.88 lb.)
Camera size (L x W x H)	106 x 201 x 125 mm (4.2 x 7.9 x 4.9 in.), with built-in lens pointing forward
Tripod mounting	UNC ¼"-20 (adapter needed)
Material	<ul style="list-style-type: none"> Polycarbonate + acrylonitrile butadiene styrene (PC-ABS) Thixomold magnesium Thermoplastic elastomer (TPE)
Color	Graphite gray and black
Shipping information	
Packaging, type	Cardboard box
List of contents	<ul style="list-style-type: none"> Infrared camera with lens Battery (2 ea.) Battery charger Bluetooth headset Camera lens cap Calibration certificate Printed documentation Hard transport case Memory card Neckstrap Power supply, incl. multi-plugs Sunshield USB cable Video cable IR lens, f = 10 mm, 45°
Packaging, weight	5.7 kg (12.6 lb.)
Packaging, size	495 x 192 x 370 mm (19.49 x 7.56 x 14.57 in.)
EAN-13	7332558010532
UPC-12	845188011192
Country of origin	Sweden

Supplies & accessories:

- 1196961; IR lens, f = 30 mm, 15° incl. case
- 1196960; IR lens, f = 10 mm, 45° incl. case
- T197215; Close-up 4x (100 µm) incl. case
- T197214; Close-up 2x (50 µm) incl. case
- T197408; IR lens, 76 mm (6°) with case and mounting support for T/B-200/400
- T197412; IR lens, 4 mm (90°) with case and mounting support for T/B2xx-4xx
- T197000; High temp. option +1200°C (+2192°F)
- T910814; Power supply, incl. multi plugs
- T197650; 2-bay battery charger, incl. power supply with multi plugs
- 1196398ACC; Battery
- T911230ACC; Memory card SDHC 4 GB
- 1910423; USB cable Std A <-> Mini-B
- T198509; Cigarette lighter adapter kit, 12 VDC, 1.2 m/3.9 ft.
- 1910582ACC; Video cable
- T198370ACC; Hard transport case for FLIR T/B2xx-4xx
- T198495; Pouch for FLIR T6xx and T4xx series
- 1124545; Pouch
- T198493; Sun shield
- T198499; Neck strap
- T197771ACC; Bluetooth Headset
- T911093; Tool belt
- 19250-100; IR Window 2 in
- 19251-100; IR Window 3 in.

- 19252-100; IR Window 4 in.
- 19250-200; SS IR Window 2 in.
- 19251-200; SS IR Window 3 in.
- 19252-200; SS IR Window 4 in.
- T198586; FLIR Reporter Professional (license only)
- T198584; FLIR Tools
- T198583; FLIR Tools+ (download card incl. license key)
- DSW-10000; FLIR IR Camera Player
- APP-10002; FLIR Tools Mobile (Android Application)
- APP-10004; FLIR Tools (MacOS Application)
- T198697; FLIR ResearchIR Max + HSDR 4 (hardware sec. dev.)
- T199014; FLIR ResearchIR Max + HSDR 4 (printed license key)
- T199044; FLIR ResearchIR Max + HSDR 4 Upgrade (printed license key)
- T198696; FLIR ResearchIR Max 4 (hardware sec. dev.)
- T199013; FLIR ResearchIR Max 4 (printed license key)
- T199043; FLIR ResearchIR Max 4 Upgrade (printed license key)
- T198731; FLIR ResearchIR Standard 4 (hardware sec. dev.)
- T199012; FLIR ResearchIR Standard 4 (printed license key)
- T199042; FLIR ResearchIR Standard 4 Upgrade (printed license key)
- T199233; FLIR Atlas SDK for .NET
- T199234; FLIR Atlas SDK for MATLAB

24.6 FLIR T420 (incl. Wi-Fi and Ext. cal.) (60 Hz)

P/N: 62103-1105

Rev.: 35943

General description	
The FLIR T420 is a camera that offers good performance at an affordable price. Excellent ergonomics, a walk-up-and-use interface, and easy communication make the FLIR T420 a truly user-friendly camera for the beginner or advanced user.	
Benefits:	
<ul style="list-style-type: none"> • Excellent ergonomics: The FLIR T420 has a tiltable infrared unit and auto-orientation, which make it easy to capture images from any angle comfortably. The small size and low weight of the camera facilitate its use over a full working day. • Affordable performance: The FLIR T420 is equipped with the innovative Multi Spectral Dynamic Imaging (MSX) feature, which produces an image richer in detail than ever before. You can highlight objects of interest, on both the infrared and the visual images, by sketching or adding predefined stamps directly onto the camera's touch screen. • Extensive communication options: The Wi-Fi connectivity of the FLIR T420 allows you to connect to smart phones or tablets, for the wireless transfer of images or the remote control of the camera. The Bluetooth-based METERLiNK function transfers readings from external measurement instruments to the infrared image. • Support for UltraMax: When enabling UltraMax in the camera, the resolution of images can be substantially enhanced when importing the images into FLIR Tools. 	
Imaging and optical data	
IR resolution	320 × 240 pixels
MSX resolution	320 × 240 pixels
UltraMax	Yes
Thermal sensitivity/NETD	<40 mK @ +30°C (+86°F)
Field of view (FOV)	25° × 19°
Minimum focus distance	0.4 m (1.31 ft.)
Focal length	18 mm (0.7 in.)
Spatial resolution (IFOV)	1.36 mrad
F-number	1.3
Image frequency	60 Hz
Focus	Automatic (one shot) or manual
Digital zoom	2× and 4×
Detector data	
Detector type	Focal plane array (FPA), uncooled microbolometer
Spectral range	7.5–13 μm
Detector pitch	25 μm
Image presentation	
Display	Touch screen, 3.5 in. LCD, 320 × 240 pixels
Auto orientation	Automatic landscape or portrait
Image adjustment	Auto or manual
Image presentation modes	
Thermal MSX	Thermal image with enhanced detail presentation
Picture in Picture	Resizable and movable IR area on visual image

Measurement	
Object temperature range	<ul style="list-style-type: none"> • -20°C to +120°C (-4°F to +248°F) • 0°C to +650°C (+32°F to +1202°F)
Accuracy	±2°C (±3.6°F) or 2%, whichever is greater, at 25°C (77°F) nominal.
Measurement analysis	
Spotmeter	5
Area	5 + 5 areas (boxes or circles) with max./min./average (in post-acquisition analysis)
Automatic hot/cold detection	Auto hot or cold spotmeter markers within area
Measurement presets	No measurements, Center spot, Hot spot, Cold spot, 3 spots, Hotspot-spot, Hotspot-temperature
Difference temperature	Delta temperature between measurement functions or reference temperature
Reference temperature	Manually set using difference temperature
Emissivity correction	Variable from 0.01 to 1.0 or selected from materials list
Measurement corrections	Emissivity, reflected temperature, relative humidity, atmospheric temperature, object distance, external IR window compensation
Colors (palettes)	Iron, Rainbow, Rainbow HC, White hot, Black hot, Arctic, Lava
Alarm	
Color Alarm (isotherm)	Above/below/interval
Measurement function alarm	Audible/visual alarms (above/below) on any selected measurement function
Screening	Difference temperature alarm, audible
Set-up	
Set-up commands	Save options, Programmable button, Reset options, Set up camera, Wi-Fi, Compass, Bluetooth, Language, Time & units, Camera information
Service functions	
Camera software update	Use PC software FLIR Tools
Storage of images	
Image storage	Standard JPEG, including digital photo and measurement data, on memory card
Image storage mode	<ul style="list-style-type: none"> • Simultaneous storage of thermal and digital photo in same JPEG file. • Optional to store digital photo as a separate JPEG file.
Time lapse	15 seconds to 24 hours
Image annotations (in still images)	
Voice	60 seconds (via Bluetooth) stored with the image
Text	Add table. Select between predefined templates or create your own in FLIR Tools
Image description	Add short note (stored in JPEG EXIF tag)

Image annotations (in still images)	
METERLiNK	Wireless connection (Bluetooth) to: FLIR meters with METERLiNK
Report generation	<ul style="list-style-type: none"> Instant Report (*.pdf file) in camera including IR and visual images Separate PC software with extensive report generation
Geographic Information System	
Compass	Camera direction automatically added to every still image
Video recording in camera	
Non-radiometric IR video recording	MPEG-4 to memory card
Visual video recording	MPEG-4 to memory card
Video streaming	
Radiometric IR video streaming	Full dynamic to PC using USB or to mobile devices using Wi-Fi.
Non-radiometric IR video streaming	<ul style="list-style-type: none"> MPEG-4 using Wi-Fi Uncompressed colorized video using USB
Visual video streaming	<ul style="list-style-type: none"> MPEG-4 using Wi-Fi Uncompressed colorized video using USB
Digital camera	
Built-in digital camera	3.1 Mpixels with LED light (photo as separate image)
Digital camera, focus	Fixed focus
Digital camera, FOV	Adapts to the IR lens
Built-in digital lens data	FOV 53° × 41°
Digital camera, aspect ratio	4:3
Laser pointer	
Laser	Activated by dedicated button
Laser alignment	Position is automatic displayed on the IR image
Laser classification	Class 2
Laser type	Semiconductor AlGaInP diode laser
Laser power	1 mW
Laser wavelength	635 nm (red)
Data communication interfaces	
Interfaces	USB-mini, USB-A, Bluetooth, Wi-Fi, composite video
METERLiNK/Bluetooth	Communication with headset and external sensors
Wi-Fi	Peer to peer (ad hoc) or infrastructure (network)
SD Card	One card slot for removable SD memory cards
USB	
USB	<ul style="list-style-type: none"> USB-A: Connect external USB device USB Mini-B: Data transfer to and from PC / uncompressed colorized video
USB, standard	USB Mini-B: 2.0

Composite video	
Video out	Composite
Video, standard	CVBS (ITU-R-BT.470 PAL/SMPTE 170M NTSC)
Video, connector type	4-pole 3.5 mm jack
Radio	
Wi-Fi	<ul style="list-style-type: none"> • Standard: 802.11 b/g • Frequency range: 2412–2462 MHz • Max. output power: 15 dBm
METERLiNK/Bluetooth	Frequency range: 2402–2480 MHz
Antenna	Internal
Power system	
Battery type	Rechargeable Li ion battery
Battery voltage	3.7 V
Battery capacity	4.4 Ah, at +20°C to +25°C (+68°F to +77°F)
Battery operating time	Approx. 4 hours at +25°C (+77°F) ambient temperature and typical use
Charging system	In camera (AC adapter or 12 V from a vehicle) or 2-bay charger
Charging time	4 h to 90% capacity, charging status indicated by LED's
Charging temperature	0°C to +45°C (+32°F to +113°F)
Power management	Automatic shutdown and sleep mode (user selectable)
AC operation	AC adapter, 90–260 VAC input, 12 V output to camera
Start-up time from sleep mode	Instant on
Environmental data	
Operating temperature range	–15°C to +50°C (+5°F to +122°F)
Storage temperature range	–40°C to +70°C (–40°F to +158°F)
Humidity (operating and storage)	IEC 60068-2-30/24 h 95% relative humidity +25°C to +40°C (+77°F to +104°F) / 2 cycles
EMC	<ul style="list-style-type: none"> • ETSI EN 301 489-1 (radio) • ETSI EN 301 489-17 • EN 61000-6-2 (Immunity) • EN 61000-6-3 (Emission) • FCC 47 CFR Part 15 B (Emission) • ICES-003
Radio spectrum	<ul style="list-style-type: none"> • ETSI EN 300 328 • FCC Part 15.247 • RSS-210
Magnetic fields	EN 61 000-4-8, Test level 5 for continuous field (severe industrial environment)
Encapsulation	IP 54 (IEC 60529)
Shock	25 g (IEC 60068-2-27)
Vibration	2 g (IEC 60068-2-6)
Safety	EN/UL/CSA/PSE 60950-1

Physical data	
Camera weight, incl. battery	0.855 kg (1.88 lb.)
Camera size (L x W x H)	106 x 201 x 125 mm (4.2 x 7.9 x 4.9 in.), with built-in lens pointing forward
Tripod mounting	UNC ¼"-20 (adapter needed)
Material	<ul style="list-style-type: none"> • Polycarbonate + acrylonitrile butadiene styrene (PC-ABS) • Thixomold magnesium • Thermoplastic elastomer (TPE)
Color	Graphite gray and black
Shipping information	
Packaging, type	Cardboard box
List of contents	<ul style="list-style-type: none"> • Infrared camera with lens • Battery (2 ea.) • Battery charger • Bluetooth headset • Camera lens cap • Calibration certificate • Extended calibration certificate • Hard transport case • Memory card • Neckstrap • Power supply, incl. multi-plugs • Printed documentation • Sunshield • USB cable • Video cable
Packaging, weight	5.7 kg (12.6 lb.)
Packaging, size	495 x 192 x 370 mm (19.49 x 7.56 x 14.57 in.)
EAN-13	7332558012123
UPC-12	845188013226
Country of origin	Sweden

Supplies & accessories:

- 1196961; IR lens, f = 30 mm, 15° incl. case
- 1196960; IR lens, f = 10 mm, 45° incl. case
- T197215; Close-up 4x (100 µm) incl. case
- T197214; Close-up 2x (50 µm) incl. case
- T197408; IR lens, 76 mm (6°) with case and mounting support for T/B-200/400
- T197412; IR lens, 4 mm (90°) with case and mounting support for T/B2xx-4xx
- T197000; High temp. option +1200°C (+2192°F)
- T910814; Power supply, incl. multi plugs
- T197650; 2-bay battery charger, incl. power supply with multi plugs
- 1196398ACC; Battery
- T911230ACC; Memory card SDHC 4 GB
- 1910423; USB cable Std A <-> Mini-B
- T198509; Cigarette lighter adapter kit, 12 VDC, 1.2 m/3.9 ft.
- 1910582ACC; Video cable
- T198370ACC; Hard transport case for FLIR T/B2xx-4xx
- T198495; Pouch for FLIR T6xx and T4xx series
- 1124545; Pouch
- T198493; Sun shield
- T198499; Neck strap
- T197771ACC; Bluetooth Headset
- T911093; Tool belt
- 19250-100; IR Window 2 in
- 19251-100; IR Window 3 in.

- 19252-100; IR Window 4 in.
- 19250-200; SS IR Window 2 in.
- 19251-200; SS IR Window 3 in.
- 19252-200; SS IR Window 4 in.
- T198586; FLIR Reporter Professional (license only)
- T198584; FLIR Tools
- T198583; FLIR Tools+ (download card incl. license key)
- DSW-10000; FLIR IR Camera Player
- APP-10002; FLIR Tools Mobile (Android Application)
- APP-10004; FLIR Tools (MacOS Application)
- T198697; FLIR ResearchIR Max + HSDR 4 (hardware sec. dev.)
- T199014; FLIR ResearchIR Max + HSDR 4 (printed license key)
- T199044; FLIR ResearchIR Max + HSDR 4 Upgrade (printed license key)
- T198696; FLIR ResearchIR Max 4 (hardware sec. dev.)
- T199013; FLIR ResearchIR Max 4 (printed license key)
- T199043; FLIR ResearchIR Max 4 Upgrade (printed license key)
- T198731; FLIR ResearchIR Standard 4 (hardware sec. dev.)
- T199012; FLIR ResearchIR Standard 4 (printed license key)
- T199042; FLIR ResearchIR Standard 4 Upgrade (printed license key)
- T199233; FLIR Atlas SDK for .NET
- T199234; FLIR Atlas SDK for MATLAB

24.7 FLIR T420 (incl. Wi-Fi)

P/N: 62103-1101

Rev.: 35207

General description	
<p>The FLIR T420 is a camera that offers good performance at an affordable price. Excellent ergonomics, a walk-up-and-use interface, and easy communication make the FLIR T420 a truly user-friendly camera for the beginner or advanced user.</p>	
Benefits:	
<ul style="list-style-type: none"> • Excellent ergonomics: The FLIR T420 has a tiltable infrared unit and auto-orientation, which make it easy to capture images from any angle comfortably. The small size and low weight of the camera facilitate its use over a full working day. • Affordable performance: The FLIR T420 is equipped with the innovative Multi Spectral Dynamic Imaging (MSX) feature, which produces an image richer in detail than ever before. You can highlight objects of interest, on both the infrared and the visual images, by sketching or adding predefined stamps directly onto the camera's touch screen. • Extensive communication options: The Wi-Fi connectivity of the FLIR T420 allows you to connect to smart phones or tablets, for the wireless transfer of images or the remote control of the camera. The Bluetooth-based METERLiNK function transfers readings from external measurement instruments to the infrared image. • Support for UltraMax: When enabling UltraMax in the camera, the resolution of images can be substantially enhanced when importing the images into FLIR Tools. 	
Imaging and optical data	
IR resolution	320 × 240 pixels
MSX resolution	320 × 240 pixels
UltraMax	Yes
Thermal sensitivity/NETD	<40 mK @ +30°C (+86°F)
Field of view (FOV)	25° × 19°
Minimum focus distance	0.4 m (1.31 ft.)
Focal length	18 mm (0.7 in.)
Spatial resolution (IFOV)	1.36 mrad
F-number	1.3
Image frequency	60 Hz
Focus	Automatic (one shot) or manual
Digital zoom	2× and 4×
Detector data	
Detector type	Focal plane array (FPA), uncooled microbolometer
Spectral range	7.5–13 μm
Detector pitch	25 μm
Image presentation	
Display	Touch screen, 3.5 in. LCD, 320 × 240 pixels
Auto orientation	Automatic landscape or portrait
Image adjustment	Auto or manual
Image presentation modes	
Thermal MSX	Thermal image with enhanced detail presentation
Picture in Picture	Resizable and movable IR area on visual image

Measurement	
Object temperature range	<ul style="list-style-type: none"> • -20°C to +120°C (-4°F to +248°F) • 0°C to +650°C (+32°F to +1202°F)
Accuracy	±2°C (±3.6°F) or 2%, whichever is greater, at 25°C (77°F) nominal.
Measurement analysis	
Spotmeter	5
Area	5 + 5 areas (boxes or circles) with max./min./average (in post-acquisition analysis)
Automatic hot/cold detection	Auto hot or cold spotmeter markers within area
Measurement presets	No measurements, Center spot, Hot spot, Cold spot, 3 spots, Hotspot-spot, Hotspot-temperature
Difference temperature	Delta temperature between measurement functions or reference temperature
Reference temperature	Manually set using difference temperature
Emissivity correction	Variable from 0.01 to 1.0 or selected from materials list
Measurement corrections	Emissivity, reflected temperature, relative humidity, atmospheric temperature, object distance, external IR window compensation
Colors (palettes)	Iron, Rainbow, Rainbow HC, White hot, Black hot, Arctic, Lava
Alarm	
Color Alarm (isotherm)	Above/below/interval
Measurement function alarm	Audible/visual alarms (above/below) on any selected measurement function
Screening	Difference temperature alarm, audible
Set-up	
Set-up commands	Save options, Programmable button, Reset options, Set up camera, Wi-Fi, Compass, Bluetooth, Language, Time & units, Camera information
Service functions	
Camera software update	Use PC software FLIR Tools
Storage of images	
Image storage	Standard JPEG, including digital photo and measurement data, on memory card
Image storage mode	<ul style="list-style-type: none"> • Simultaneous storage of thermal and digital photo in same JPEG file. • Optional to store digital photo as a separate JPEG file.
Time lapse	15 seconds to 24 hours
Image annotations (in still images)	
Voice	60 seconds (via Bluetooth) stored with the image
Text	Add table. Select between predefined templates or create your own in FLIR Tools
Image description	Add short note (stored in JPEG EXIF tag)

Image annotations (in still images)	
METERLiNK	Wireless connection (Bluetooth) to: FLIR meters with METERLiNK
Report generation	<ul style="list-style-type: none"> Instant Report (*.pdf file) in camera including IR and visual images Separate PC software with extensive report generation
Geographic Information System	
Compass	Camera direction automatically added to every still image
Video recording in camera	
Non-radiometric IR video recording	MPEG-4 to memory card
Visual video recording	MPEG-4 to memory card
Video streaming	
Radiometric IR video streaming	Full dynamic to PC using USB or to mobile devices using Wi-Fi.
Non-radiometric IR video streaming	<ul style="list-style-type: none"> MPEG-4 using Wi-Fi Uncompressed colorized video using USB
Visual video streaming	<ul style="list-style-type: none"> MPEG-4 using Wi-Fi Uncompressed colorized video using USB
Digital camera	
Built-in digital camera	3.1 Mpixels with LED light (photo as separate image)
Digital camera, focus	Fixed focus
Digital camera, FOV	Adapts to the IR lens
Built-in digital lens data	FOV 53° × 41°
Digital camera, aspect ratio	4:3
Laser pointer	
Laser	Activated by dedicated button
Laser alignment	Position is automatic displayed on the IR image
Laser classification	Class 2
Laser type	Semiconductor AlGaInP diode laser
Laser power	1 mW
Laser wavelength	635 nm (red)
Data communication interfaces	
Interfaces	USB-mini, USB-A, Bluetooth, Wi-Fi, composite video
METERLiNK/Bluetooth	Communication with headset and external sensors
Wi-Fi	Peer to peer (ad hoc) or infrastructure (network)
SD Card	One card slot for removable SD memory cards
USB	
USB	<ul style="list-style-type: none"> USB-A: Connect external USB device USB Mini-B: Data transfer to and from PC / uncompressed colorized video
USB, standard	USB Mini-B: 2.0

Composite video	
Video out	Composite
Video, standard	CVBS (ITU-R-BT.470 PAL/SMPTE 170M NTSC)
Video, connector type	4-pole 3.5 mm jack
Radio	
Wi-Fi	<ul style="list-style-type: none"> • Standard: 802.11 b/g • Frequency range: 2412–2462 MHz • Max. output power: 15 dBm
METERLiNK/Bluetooth	Frequency range: 2402–2480 MHz
Antenna	Internal
Power system	
Battery type	Rechargeable Li ion battery
Battery voltage	3.7 V
Battery capacity	4.4 Ah, at +20°C to +25°C (+68°F to +77°F)
Battery operating time	Approx. 4 hours at +25°C (+77°F) ambient temperature and typical use
Charging system	In camera (AC adapter or 12 V from a vehicle) or 2-bay charger
Charging time	4 h to 90% capacity, charging status indicated by LED's
Charging temperature	0°C to +45°C (+32°F to +113°F)
Power management	Automatic shutdown and sleep mode (user selectable)
AC operation	AC adapter, 90–260 VAC input, 12 V output to camera
Start-up time from sleep mode	Instant on
Environmental data	
Operating temperature range	–15°C to +50°C (+5°F to +122°F)
Storage temperature range	–40°C to +70°C (–40°F to +158°F)
Humidity (operating and storage)	IEC 60068-2-30/24 h 95% relative humidity +25°C to +40°C (+77°F to +104°F) / 2 cycles
EMC	<ul style="list-style-type: none"> • ETSI EN 301 489-1 (radio) • ETSI EN 301 489-17 • EN 61000-6-2 (Immunity) • EN 61000-6-3 (Emission) • FCC 47 CFR Part 15 B (Emission) • ICES-003
Radio spectrum	<ul style="list-style-type: none"> • ETSI EN 300 328 • FCC Part 15.247 • RSS-210
Magnetic fields	EN 61 000-4-8, Test level 5 for continuous field (severe industrial environment)
Encapsulation	IP 54 (IEC 60529)
Shock	25 g (IEC 60068-2-27)
Vibration	2 g (IEC 60068-2-6)
Safety	EN/UL/CSA/PSE 60950-1

Physical data	
Camera weight, incl. battery	0.855 kg (1.88 lb.)
Camera size (L x W x H)	106 x 201 x 125 mm (4.2 x 7.9 x 4.9 in.), with built-in lens pointing forward
Tripod mounting	UNC ¼"-20 (adapter needed)
Material	<ul style="list-style-type: none"> Polycarbonate + acrylonitrile butadiene styrene (PC-ABS) Thixomold magnesium Thermoplastic elastomer (TPE)
Color	Graphite gray and black
Shipping information	
Packaging, type	Cardboard box
List of contents	<ul style="list-style-type: none"> Infrared camera with lens Battery (2 ea.) Battery charger Bluetooth headset Camera lens cap Calibration certificate Printed documentation Hard transport case Memory card Neckstrap Power supply, incl. multi-plugs Sunshield USB cable Video cable
Packaging, weight	5.7 kg (12.6 lb.)
Packaging, size	495 x 192 x 370 mm (19.49 x 7.56 x 14.57 in.)
EAN-13	7332558006474
UPC-12	845188006822
Country of origin	Sweden

Supplies & accessories:

- 1196961; IR lens, f = 30 mm, 15° incl. case
- 1196960; IR lens, f = 10 mm, 45° incl. case
- T197215; Close-up 4x (100 µm) incl. case
- T197214; Close-up 2x (50 µm) incl. case
- T197408; IR lens, 76 mm (6°) with case and mounting support for T/B-200/400
- T197412; IR lens, 4 mm (90°) with case and mounting support for T/B2xx-4xx
- T197000; High temp. option +1200°C (+2192°F)
- T910814; Power supply, incl. multi plugs
- T197650; 2-bay battery charger, incl. power supply with multi plugs
- 1196398ACC; Battery
- T911230ACC; Memory card SDHC 4 GB
- 1910423; USB cable Std A <-> Mini-B
- T198509; Cigarette lighter adapter kit, 12 VDC, 1.2 m/3.9 ft.
- 1910582ACC; Video cable
- T198370ACC; Hard transport case for FLIR T/B2xx-4xx
- T198495; Pouch for FLIR T6xx and T4xx series
- 1124545; Pouch
- T198493; Sun shield
- T198499; Neck strap
- T197771ACC; Bluetooth Headset
- T911093; Tool belt
- 19250-100; IR Window 2 in
- 19251-100; IR Window 3 in.
- 19252-100; IR Window 4 in.

- 19250-200; SS IR Window 2 in.
- 19251-200; SS IR Window 3 in.
- 19252-200; SS IR Window 4 in.
- T198586; FLIR Reporter Professional (license only)
- T198584; FLIR Tools
- T198583; FLIR Tools+ (download card incl. license key)
- DSW-10000; FLIR IR Camera Player
- APP-10002; FLIR Tools Mobile (Android Application)
- APP-10004; FLIR Tools (MacOS Application)
- T198697; FLIR ResearchIR Max + HSDR 4 (hardware sec. dev.)
- T199014; FLIR ResearchIR Max + HSDR 4 (printed license key)
- T199044; FLIR ResearchIR Max + HSDR 4 Upgrade (printed license key)
- T198696; FLIR ResearchIR Max 4 (hardware sec. dev.)
- T199013; FLIR ResearchIR Max 4 (printed license key)
- T199043; FLIR ResearchIR Max 4 Upgrade (printed license key)
- T198731; FLIR ResearchIR Standard 4 (hardware sec. dev.)
- T199012; FLIR ResearchIR Standard 4 (printed license key)
- T199042; FLIR ResearchIR Standard 4 Upgrade (printed license key)
- T199233; FLIR Atlas SDK for .NET
- T199234; FLIR Atlas SDK for MATLAB

24.8 FLIR T420 with SC kit (incl. Wi-Fi, incl. 45° lens)

P/N: 62103-1205

Rev.: 35207

General description	
The FLIR T420 is a camera that offers good performance at an affordable price. Excellent ergonomics, a walk-up-and-use interface, and easy communication make the FLIR T420 a truly user-friendly camera for the beginner or advanced user.	
Benefits:	
<ul style="list-style-type: none"> • Excellent ergonomics: The FLIR T420 has a tiltable infrared unit and auto-orientation, which make it easy to capture images from any angle comfortably. The small size and low weight of the camera facilitate its use over a full working day. • Affordable performance: The FLIR T420 is equipped with the innovative Multi Spectral Dynamic Imaging (MSX) feature, which produces an image richer in detail than ever before. You can highlight objects of interest, on both the infrared and the visual images, by sketching or adding predefined stamps directly onto the camera's touch screen. • Extensive communication options: The Wi-Fi connectivity of the FLIR T420 allows you to connect to smart phones or tablets, for the wireless transfer of images or the remote control of the camera. The Bluetooth-based METERLiNK function transfers readings from external measurement instruments to the infrared image. • Support for UltraMax: When enabling UltraMax in the camera, the resolution of images can be substantially enhanced when importing the images into FLIR Tools. 	
Imaging and optical data	
IR resolution	320 × 240 pixels
MSX resolution	320 × 240 pixels
UltraMax	Yes
Thermal sensitivity/NETD	<40 mK @ +30°C (+86°F)
Field of view (FOV)	25° × 19°
Minimum focus distance	0.4 m (1.31 ft.)
Focal length	18 mm (0.7 in.)
Spatial resolution (IFOV)	1.36 mrad
F-number	1.3
Image frequency	60 Hz
Focus	Automatic (one shot) or manual
Digital zoom	2× and 4×
Detector data	
Detector type	Focal plane array (FPA), uncooled microbolometer
Spectral range	7.5–13 μm
Detector pitch	25 μm
Image presentation	
Display	Touch screen, 3.5 in. LCD, 320 × 240 pixels
Auto orientation	Automatic landscape or portrait
Image adjustment	Auto or manual
Image presentation modes	
Thermal MSX	Thermal image with enhanced detail presentation
Picture in Picture	Resizable and movable IR area on visual image

Measurement	
Object temperature range	<ul style="list-style-type: none"> • -20°C to +120°C (-4°F to +248°F) • 0°C to +650°C (+32°F to +1202°F)
Accuracy	±2°C (±3.6°F) or 2%, whichever is greater, at 25°C (77°F) nominal.
Measurement analysis	
Spotmeter	5
Area	5 + 5 areas (boxes or circles) with max./min./average (in post-acquisition analysis)
Automatic hot/cold detection	Auto hot or cold spotmeter markers within area
Measurement presets	No measurements, Center spot, Hot spot, Cold spot, 3 spots, Hotspot-spot, Hotspot-temperature
Difference temperature	Delta temperature between measurement functions or reference temperature
Reference temperature	Manually set using difference temperature
Emissivity correction	Variable from 0.01 to 1.0 or selected from materials list
Measurement corrections	Emissivity, reflected temperature, relative humidity, atmospheric temperature, object distance, external IR window compensation
Colors (palettes)	Iron, Rainbow, Rainbow HC, White hot, Black hot, Arctic, Lava
Alarm	
Color Alarm (isotherm)	Above/below/interval
Measurement function alarm	Audible/visual alarms (above/below) on any selected measurement function
Screening	Difference temperature alarm, audible
Set-up	
Set-up commands	Save options, Programmable button, Reset options, Set up camera, Wi-Fi, Compass, Bluetooth, Language, Time & units, Camera information
Service functions	
Camera software update	Use PC software FLIR Tools
Storage of images	
Image storage	Standard JPEG, including digital photo and measurement data, on memory card
Image storage mode	<ul style="list-style-type: none"> • Simultaneous storage of thermal and digital photo in same JPEG file. • Optional to store digital photo as a separate JPEG file.
Time lapse	15 seconds to 24 hours
Image annotations (in still images)	
Voice	60 seconds (via Bluetooth) stored with the image
Text	Add table. Select between predefined templates or create your own in FLIR Tools
Image description	Add short note (stored in JPEG EXIF tag)

Image annotations (in still images)	
METERLiNK	Wireless connection (Bluetooth) to: FLIR meters with METERLiNK
Report generation	<ul style="list-style-type: none"> Instant Report (*.pdf file) in camera including IR and visual images Separate PC software with extensive report generation
Geographic Information System	
Compass	Camera direction automatically added to every still image
Video recording in camera	
Non-radiometric IR video recording	MPEG-4 to memory card
Visual video recording	MPEG-4 to memory card
Video streaming	
Radiometric IR video streaming	Full dynamic to PC using USB or to mobile devices using Wi-Fi.
Non-radiometric IR video streaming	<ul style="list-style-type: none"> MPEG-4 using Wi-Fi Uncompressed colorized video using USB
Visual video streaming	<ul style="list-style-type: none"> MPEG-4 using Wi-Fi Uncompressed colorized video using USB
Digital camera	
Built-in digital camera	3.1 Mpixels with LED light (photo as separate image)
Digital camera, focus	Fixed focus
Digital camera, FOV	Adapts to the IR lens
Built-in digital lens data	FOV 53° × 41°
Digital camera, aspect ratio	4:3
Laser pointer	
Laser	Activated by dedicated button
Laser alignment	Position is automatic displayed on the IR image
Laser classification	Class 2
Laser type	Semiconductor AlGaInP diode laser
Laser power	1 mW
Laser wavelength	635 nm (red)
Data communication interfaces	
Interfaces	USB-mini, USB-A, Bluetooth, Wi-Fi, composite video
METERLiNK/Bluetooth	Communication with headset and external sensors
Wi-Fi	Peer to peer (ad hoc) or infrastructure (network)
SD Card	One card slot for removable SD memory cards
USB	
USB	<ul style="list-style-type: none"> USB-A: Connect external USB device USB Mini-B: Data transfer to and from PC / uncompressed colorized video
USB, standard	USB Mini-B: 2.0

Composite video	
Video out	Composite
Video, standard	CVBS (ITU-R-BT.470 PAL/SMPTE 170M NTSC)
Video, connector type	4-pole 3.5 mm jack
Radio	
Wi-Fi	<ul style="list-style-type: none"> • Standard: 802.11 b/g • Frequency range: 2412–2462 MHz • Max. output power: 15 dBm
METERLiNK/Bluetooth	Frequency range: 2402–2480 MHz
Antenna	Internal
Power system	
Battery type	Rechargeable Li ion battery
Battery voltage	3.7 V
Battery capacity	4.4 Ah, at +20°C to +25°C (+68°F to +77°F)
Battery operating time	Approx. 4 hours at +25°C (+77°F) ambient temperature and typical use
Charging system	In camera (AC adapter or 12 V from a vehicle) or 2-bay charger
Charging time	4 h to 90% capacity, charging status indicated by LED's
Charging temperature	0°C to +45°C (+32°F to +113°F)
Power management	Automatic shutdown and sleep mode (user selectable)
AC operation	AC adapter, 90–260 VAC input, 12 V output to camera
Start-up time from sleep mode	Instant on
Environmental data	
Operating temperature range	–15°C to +50°C (+5°F to +122°F)
Storage temperature range	–40°C to +70°C (–40°F to +158°F)
Humidity (operating and storage)	IEC 60068-2-30/24 h 95% relative humidity +25°C to +40°C (+77°F to +104°F) / 2 cycles
EMC	<ul style="list-style-type: none"> • ETSI EN 301 489-1 (radio) • ETSI EN 301 489-17 • EN 61000-6-2 (Immunity) • EN 61000-6-3 (Emission) • FCC 47 CFR Part 15 B (Emission) • ICES-003
Radio spectrum	<ul style="list-style-type: none"> • ETSI EN 300 328 • FCC Part 15.247 • RSS-210
Magnetic fields	EN 61 000-4-8, Test level 5 for continuous field (severe industrial environment)
Encapsulation	IP 54 (IEC 60529)
Shock	25 g (IEC 60068-2-27)
Vibration	2 g (IEC 60068-2-6)
Safety	EN/UL/CSA/PSE 60950-1

Physical data	
Camera weight, incl. battery	0.855 kg (1.88 lb.)
Camera size (L x W x H)	106 x 201 x 125 mm (4.2 x 7.9 x 4.9 in.), with built-in lens pointing forward
Tripod mounting	UNC ¼"-20 (adapter needed)
Material	<ul style="list-style-type: none"> Polycarbonate + acrylonitrile butadiene styrene (PC-ABS) Thixomold magnesium Thermoplastic elastomer (TPE)
Color	Graphite gray and black
Shipping information	
Packaging, type	Cardboard box
List of contents	<ul style="list-style-type: none"> Infrared camera with lens Battery (2 ea.) Battery charger Camera lens cap Calibration certificate FLIR ResearchIR Standard 4 IR lens, f = 10 mm, 45° incl. case Printed documentation Hard transport case Memory card Neckstrap Power supply, incl. multi-plugs Sunshield USB cable Video cable
Packaging, weight	
Packaging, size	495 x 192 x 370 mm (19.49 x 7.56 x 14.57 in.)
EAN-13	7332558008515
UPC-12	845188008871
Country of origin	Sweden

Supplies & accessories:

- 1196961; IR lens, f = 30 mm, 15° incl. case
- 1196960; IR lens, f = 10 mm, 45° incl. case
- T197215; Close-up 4x (100 µm) incl. case
- T197214; Close-up 2x (50 µm) incl. case
- T197408; IR lens, 76 mm (6°) with case and mounting support for T/B-200/400
- T197412; IR lens, 4 mm (90°) with case and mounting support for T/B2xx-4xx
- T197000; High temp. option +1200°C (+2192°F)
- T910814; Power supply, incl. multi plugs
- T197650; 2-bay battery charger, incl. power supply with multi plugs
- 1196398ACC; Battery
- T911230ACC; Memory card SDHC 4 GB
- 1910423; USB cable Std A <-> Mini-B
- T198509; Cigarette lighter adapter kit, 12 VDC, 1.2 m/3.9 ft.
- 1910582ACC; Video cable
- T198370ACC; Hard transport case for FLIR T/B2xx-4xx
- T198495; Pouch for FLIR T6xx and T4xx series
- 1124545; Pouch
- T198493; Sun shield
- T198499; Neck strap
- T197771ACC; Bluetooth Headset
- T911093; Tool belt
- 19250-100; IR Window 2 in
- 19251-100; IR Window 3 in.

- 19252-100; IR Window 4 in.
- 19250-200; SS IR Window 2 in.
- 19251-200; SS IR Window 3 in.
- 19252-200; SS IR Window 4 in.
- T198586; FLIR Reporter Professional (license only)
- T198584; FLIR Tools
- T198583; FLIR Tools+ (download card incl. license key)
- DSW-10000; FLIR IR Camera Player
- APP-10002; FLIR Tools Mobile (Android Application)
- APP-10004; FLIR Tools (MacOS Application)
- T198697; FLIR ResearchIR Max + HSDR 4 (hardware sec. dev.)
- T199014; FLIR ResearchIR Max + HSDR 4 (printed license key)
- T199044; FLIR ResearchIR Max + HSDR 4 Upgrade (printed license key)
- T198696; FLIR ResearchIR Max 4 (hardware sec. dev.)
- T199013; FLIR ResearchIR Max 4 (printed license key)
- T199043; FLIR ResearchIR Max 4 Upgrade (printed license key)
- T198731; FLIR ResearchIR Standard 4 (hardware sec. dev.)
- T199012; FLIR ResearchIR Standard 4 (printed license key)
- T199042; FLIR ResearchIR Standard 4 Upgrade (printed license key)
- T199233; FLIR Atlas SDK for .NET
- T199234; FLIR Atlas SDK for MATLAB

24.9 FLIR T420bx (incl. Wi-Fi and Ext. cal.) (60 Hz)

P/N: 62103-1502

Rev.: 35945

General description	
The FLIR T420bx is a camera that offers good performance at an affordable price. Excellent ergonomics, a walk-up-and-use interface, and easy communication make the FLIR T420bx a truly user-friendly camera for the beginner or advanced user.	
Benefits:	
<ul style="list-style-type: none"> • Excellent ergonomics: The FLIR T420bx has a tiltable infrared unit and auto-orientation, which make it easy to capture images from any angle comfortably. The small size and low weight of the camera facilitate its use over a full working day. • Affordable performance: The FLIR T420bx is equipped with the innovative Multi Spectral Dynamic Imaging (MSX) feature, which produces an image richer in detail than ever before. You can highlight objects of interest, on both the infrared and the visual image, by sketching or adding predefined stamps directly onto the camera's touch screen. • Extensive communication options: The Wi-Fi connectivity of the FLIR T420bx allows you to connect to smart phones or tablets, for the wireless transfer of images or the remote control of the camera. The Bluetooth-based METERLiNK function transfers readings from external measurement instruments to the infrared image. • Support for UltraMax: When enabling UltraMax in the camera, the resolution of images can be substantially enhanced when importing the images into FLIR Tools. 	
Imaging and optical data	
IR resolution	320 × 240 pixels
MSX resolution	320 × 240 pixels
UltraMax	Yes
Thermal sensitivity/NETD	<30 mK @ +30°C (+86°F)
Field of view (FOV)	25° × 19°
Minimum focus distance	0.4 m (1.31 ft.)
Focal length	18 mm (0.7 in.)
Spatial resolution (IFOV)	1.36 mrad
F-number	1.3
Image frequency	60 Hz
Focus	Automatic (one shot) or manual
Digital zoom	2× and 4×
Detector data	
Detector type	Focal plane array (FPA), uncooled microbolometer
Spectral range	7.5–13 μm
Detector pitch	25 μm
Image presentation	
Display	Touch screen, 3.5 in. LCD, 320 × 240 pixels
Auto orientation	Automatic landscape or portrait
Image adjustment	Auto or manual
Image presentation modes	
Thermal MSX	Thermal image with enhanced detail presentation
Picture in Picture	Resizable and movable IR area on visual image

Measurement	
Object temperature range	<ul style="list-style-type: none"> • -20°C to +120°C (-4°F to +248°F) • 0°C to +350°C (+32°F to +662°F)
Accuracy	±2°C (±3.6°F) or 2%, whichever is greater, at 25°C (77°F) nominal.
Measurement analysis	
Spotmeter	5
Area	5 + 5 areas (boxes or circles) with max./min./average (in post-acquisition analysis)
Automatic hot/cold detection	Auto hot or cold spotmeter markers within area
Measurement presets	No measurements, Center spot, Hot spot, Cold spot, 3 spots, Hotspot-spot, Hotspot-temperature
Difference temperature	Delta temperature between measurement functions or reference temperature
Reference temperature	Manually set using difference temperature
Emissivity correction	Variable from 0.01 to 1.0 or selected from materials list
Measurement corrections	Emissivity, reflected temperature, relative humidity, atmospheric temperature, object distance, external IR window compensation
Colors (palettes)	Iron, Rainbow, Rainbow HC, White hot, Black hot, Arctic, Lava
Alarm	
Color Alarm (isotherm)	Above/below/interval
Measurement function alarm	Audible/visual alarms (above/below) on any selected measurement function
Screening	Difference temperature alarm, audible
Humidity alarm	1 humidity alarm, including dew point alarm
Insulation alarm	1 insulation alarm
Set-up	
Set-up commands	Save options, Programmable button, Reset options, Set up camera, Wi-Fi, Compass, Bluetooth, Language, Time & units, Camera information
Service functions	
Camera software update	Use PC software FLIR Tools
Storage of images	
Image storage	Standard JPEG, including digital photo and measurement data, on memory card
Image storage mode	<ul style="list-style-type: none"> • Simultaneous storage of thermal and digital photo in same JPEG file. • Optional to store digital photo as a separate JPEG file.
Time lapse	15 seconds to 24 hours
Image annotations (in still images)	
Voice	60 seconds (via Bluetooth) stored with the image
Text	Add table. Select between predefined templates or create your own in FLIR Tools
Image description	Add short note (stored in JPEG EXIF tag)

Image annotations (in still images)	
METERLiNK	Wireless connection (Bluetooth) to: FLIR meters with METERLiNK
Report generation	<ul style="list-style-type: none"> Instant Report (*.pdf file) in camera including IR and visual images Separate PC software with extensive report generation
Geographic Information System	
Compass	Camera direction automatically added to every still image
Video recording in camera	
Non-radiometric IR video recording	MPEG-4 to memory card
Visual video recording	MPEG-4 to memory card
Video streaming	
Radiometric IR video streaming	Full dynamic to PC using USB or to mobile devices using Wi-Fi.
Non-radiometric IR video streaming	<ul style="list-style-type: none"> MPEG-4 using Wi-Fi Uncompressed colorized video using USB
Visual video streaming	<ul style="list-style-type: none"> MPEG-4 using Wi-Fi Uncompressed colorized video using USB
Digital camera	
Built-in digital camera	3.1 Mpixels with LED light (photo as separate image)
Digital camera, focus	Fixed focus
Digital camera, FOV	Adapts to the IR lens
Built-in digital lens data	FOV 53° × 41°
Digital camera, aspect ratio	4:3
Laser pointer	
Laser	Activated by dedicated button
Laser alignment	Position is automatic displayed on the IR image
Laser classification	Class 2
Laser type	Semiconductor AlGaInP diode laser
Laser power	1 mW
Laser wavelength	635 nm (red)
Data communication interfaces	
Interfaces	USB-mini, USB-A, Bluetooth, Wi-Fi, composite video
METERLiNK/Bluetooth	Communication with headset and external sensors
Wi-Fi	Peer to peer (ad hoc) or infrastructure (network)
SD Card	One card slot for removable SD memory cards
USB	
USB	<ul style="list-style-type: none"> USB-A: Connect external USB device USB Mini-B: Data transfer to and from PC / uncompressed colorized video
USB, standard	USB Mini-B: 2.0

Composite video	
Video out	Composite
Video, standard	CVBS (ITU-R-BT.470 PAL/SMPTE 170M NTSC)
Video, connector type	4-pole 3.5 mm jack
Radio	
Wi-Fi	<ul style="list-style-type: none"> • Standard: 802.11 b/g • Frequency range: 2412–2462 MHz • Max. output power: 15 dBm
METERLiNK/Bluetooth	Frequency range: 2402–2480 MHz
Antenna	Internal
Power system	
Battery type	Rechargeable Li ion battery
Battery voltage	3.7 V
Battery capacity	4.4 Ah, at +20°C to +25°C (+68°F to +77°F)
Battery operating time	Approx. 4 hours at +25°C (+77°F) ambient temperature and typical use
Charging system	In camera (AC adapter or 12 V from a vehicle) or 2-bay charger
Charging time	4 h to 90% capacity, charging status indicated by LED's
Charging temperature	0°C to +45°C (+32°F to +113°F)
Power management	Automatic shutdown and sleep mode (user selectable)
AC operation	AC adapter, 90–260 VAC input, 12 V output to camera
Start-up time from sleep mode	Instant on
Environmental data	
Operating temperature range	–15°C to +50°C (+5°F to +122°F)
Storage temperature range	–40°C to +70°C (–40°F to +158°F)
Humidity (operating and storage)	IEC 60068-2-30/24 h 95% relative humidity +25°C to +40°C (+77°F to +104°F) / 2 cycles
EMC	<ul style="list-style-type: none"> • ETSI EN 301 489-1 (radio) • ETSI EN 301 489-17 • EN 61000-6-2 (Immunity) • EN 61000-6-3 (Emission) • FCC 47 CFR Part 15 B (Emission) • ICES-003
Radio spectrum	<ul style="list-style-type: none"> • ETSI EN 300 328 • FCC Part 15.247 • RSS-210
Magnetic fields	EN 61 000-4-8, Test level 5 for continuous field (severe industrial environment)
Encapsulation	IP 54 (IEC 60529)
Shock	25 g (IEC 60068-2-27)
Vibration	2 g (IEC 60068-2-6)
Safety	EN/UL/CSA/PSE 60950-1

Physical data	
Camera weight, incl. battery	0.855 kg (1.88 lb.)
Camera size (L x W x H)	106 x 201 x 125 mm (4.2 x 7.9 x 4.9 in.), with built-in lens pointing forward
Tripod mounting	UNC ¼"-20 (adapter needed)
Material	<ul style="list-style-type: none"> Polycarbonate + acrylonitrile butadiene styrene (PC-ABS) Thixomold magnesium Thermoplastic elastomer (TPE)
Color	Graphite gray and black
Shipping information	
Packaging, type	Cardboard box
List of contents	<ul style="list-style-type: none"> Infrared camera with lens Battery (2 ea.) Battery charger Bluetooth headset Camera lens cap Calibration certificate Extended calibration certificate Hard transport case Memory card Neckstrap Power supply, incl. multi-plugs Printed documentation Sunshield USB cable Video cable
Packaging, weight	5.7 kg (12.6 lb.)
Packaging, size	495 x 192 x 370 mm (19.49 x 7.56 x 14.57 in.)
EAN-13	7332558012147
UPC-12	845188013240
Country of origin	Sweden

Supplies & accessories:

- 1196961; IR lens, f = 30 mm, 15° incl. case
- 1196960; IR lens, f = 10 mm, 45° incl. case
- T197215; Close-up 4x (100 µm) incl. case
- T197214; Close-up 2x (50 µm) incl. case
- T197408; IR lens, 76 mm (6°) with case and mounting support for T/B-200/400
- T197412; IR lens, 4 mm (90°) with case and mounting support for T/B2xx-4xx
- T197000; High temp. option +1200°C (+2192°F)
- T910814; Power supply, incl. multi plugs
- T197650; 2-bay battery charger, incl. power supply with multi plugs
- 1196398ACC; Battery
- T911230ACC; Memory card SDHC 4 GB
- 1910423; USB cable Std A <-> Mini-B
- T198509; Cigarette lighter adapter kit, 12 VDC, 1.2 m/3.9 ft.
- 1910582ACC; Video cable
- T198370ACC; Hard transport case for FLIR T/B2xx-4xx
- T198495; Pouch for FLIR T6xx and T4xx series
- 1124545; Pouch
- T198493; Sun shield
- T198499; Neck strap
- T197771ACC; Bluetooth Headset
- T911093; Tool belt
- 19250-100; IR Window 2 in
- 19251-100; IR Window 3 in.

- 19252-100; IR Window 4 in.
- 19250-200; SS IR Window 2 in.
- 19251-200; SS IR Window 3 in.
- 19252-200; SS IR Window 4 in.
- T198586; FLIR Reporter Professional (license only)
- T198584; FLIR Tools
- T198583; FLIR Tools+ (download card incl. license key)
- DSW-10000; FLIR IR Camera Player
- APP-10002; FLIR Tools Mobile (Android Application)
- APP-10004; FLIR Tools (MacOS Application)
- T198697; FLIR ResearchIR Max + HSDR 4 (hardware sec. dev.)
- T199014; FLIR ResearchIR Max + HSDR 4 (printed license key)
- T199044; FLIR ResearchIR Max + HSDR 4 Upgrade (printed license key)
- T198696; FLIR ResearchIR Max 4 (hardware sec. dev.)
- T199013; FLIR ResearchIR Max 4 (printed license key)
- T199043; FLIR ResearchIR Max 4 Upgrade (printed license key)
- T198731; FLIR ResearchIR Standard 4 (hardware sec. dev.)
- T199012; FLIR ResearchIR Standard 4 (printed license key)
- T199042; FLIR ResearchIR Standard 4 Upgrade (printed license key)
- T199233; FLIR Atlas SDK for .NET
- T199234; FLIR Atlas SDK for MATLAB

24.10 FLIR T420bx (incl. Wi-Fi)

P/N: 62103-1501

Rev.: 35207

General description	
The FLIR T420bx is a camera that offers good performance at an affordable price. Excellent ergonomics, a walk-up-and-use interface, and easy communication make the FLIR T420bx a truly user-friendly camera for the beginner or advanced user.	
Benefits:	
<ul style="list-style-type: none"> • Excellent ergonomics: The FLIR T420bx has a tiltable infrared unit and auto-orientation, which make it easy to capture images from any angle comfortably. The small size and low weight of the camera facilitate its use over a full working day. • Affordable performance: The FLIR T420bx is equipped with the innovative Multi Spectral Dynamic Imaging (MSX) feature, which produces an image richer in detail than ever before. You can highlight objects of interest, on both the infrared and the visual image, by sketching or adding predefined stamps directly onto the camera's touch screen. • Extensive communication options: The Wi-Fi connectivity of the FLIR T420bx allows you to connect to smart phones or tablets, for the wireless transfer of images or the remote control of the camera. The Bluetooth-based METERLiNK function transfers readings from external measurement instruments to the infrared image. • Support for UltraMax: When enabling UltraMax in the camera, the resolution of images can be substantially enhanced when importing the images into FLIR Tools. 	
Imaging and optical data	
IR resolution	320 × 240 pixels
MSX resolution	320 × 240 pixels
UltraMax	Yes
Thermal sensitivity/NETD	<30 mK @ +30°C (+86°F)
Field of view (FOV)	25° × 19°
Minimum focus distance	0.4 m (1.31 ft.)
Focal length	18 mm (0.7 in.)
Spatial resolution (IFOV)	1.36 mrad
F-number	1.3
Image frequency	60 Hz
Focus	Automatic (one shot) or manual
Digital zoom	2× and 4×
Detector data	
Detector type	Focal plane array (FPA), uncooled microbolometer
Spectral range	7.5–13 μm
Detector pitch	25 μm
Image presentation	
Display	Touch screen, 3.5 in. LCD, 320 × 240 pixels
Auto orientation	Automatic landscape or portrait
Image adjustment	Auto or manual
Image presentation modes	
Thermal MSX	Thermal image with enhanced detail presentation
Picture in Picture	Resizable and movable IR area on visual image

Measurement	
Object temperature range	<ul style="list-style-type: none"> • -20°C to +120°C (-4°F to +248°F) • 0°C to +350°C (+32°F to +662°F)
Accuracy	±2°C (±3.6°F) or 2%, whichever is greater, at 25°C (77°F) nominal.
Measurement analysis	
Spotmeter	5
Area	5 + 5 areas (boxes or circles) with max./min./average (in post-acquisition analysis)
Automatic hot/cold detection	Auto hot or cold spotmeter markers within area
Measurement presets	No measurements, Center spot, Hot spot, Cold spot, 3 spots, Hotspot-spot, Hotspot-temperature
Difference temperature	Delta temperature between measurement functions or reference temperature
Reference temperature	Manually set using difference temperature
Emissivity correction	Variable from 0.01 to 1.0 or selected from materials list
Measurement corrections	Emissivity, reflected temperature, relative humidity, atmospheric temperature, object distance, external IR window compensation
Colors (palettes)	Iron, Rainbow, Rainbow HC, White hot, Black hot, Arctic, Lava
Alarm	
Color Alarm (isotherm)	Above/below/interval
Measurement function alarm	Audible/visual alarms (above/below) on any selected measurement function
Screening	Difference temperature alarm, audible
Humidity alarm	1 humidity alarm, including dew point alarm
Insulation alarm	1 insulation alarm
Set-up	
Set-up commands	Save options, Programmable button, Reset options, Set up camera, Wi-Fi, Compass, Bluetooth, Language, Time & units, Camera information
Service functions	
Camera software update	Use PC software FLIR Tools
Storage of images	
Image storage	Standard JPEG, including digital photo and measurement data, on memory card
Image storage mode	<ul style="list-style-type: none"> • Simultaneous storage of thermal and digital photo in same JPEG file. • Optional to store digital photo as a separate JPEG file.
Time lapse	15 seconds to 24 hours
Image annotations (in still images)	
Voice	60 seconds (via Bluetooth) stored with the image
Text	Add table. Select between predefined templates or create your own in FLIR Tools
Image description	Add short note (stored in JPEG EXIF tag)

Image annotations (in still images)	
METERLiNK	Wireless connection (Bluetooth) to: FLIR meters with METERLiNK
Report generation	<ul style="list-style-type: none"> Instant Report (*.pdf file) in camera including IR and visual images Separate PC software with extensive report generation
Geographic Information System	
Compass	Camera direction automatically added to every still image
Video recording in camera	
Non-radiometric IR video recording	MPEG-4 to memory card
Visual video recording	MPEG-4 to memory card
Video streaming	
Radiometric IR video streaming	Full dynamic to PC using USB or to mobile devices using Wi-Fi.
Non-radiometric IR video streaming	<ul style="list-style-type: none"> MPEG-4 using Wi-Fi Uncompressed colorized video using USB
Visual video streaming	<ul style="list-style-type: none"> MPEG-4 using Wi-Fi Uncompressed colorized video using USB
Digital camera	
Built-in digital camera	3.1 Mpixels with LED light (photo as separate image)
Digital camera, focus	Fixed focus
Digital camera, FOV	Adapts to the IR lens
Built-in digital lens data	FOV 53° × 41°
Digital camera, aspect ratio	4:3
Laser pointer	
Laser	Activated by dedicated button
Laser alignment	Position is automatic displayed on the IR image
Laser classification	Class 2
Laser type	Semiconductor AlGaInP diode laser
Laser power	1 mW
Laser wavelength	635 nm (red)
Data communication interfaces	
Interfaces	USB-mini, USB-A, Bluetooth, Wi-Fi, composite video
METERLiNK/Bluetooth	Communication with headset and external sensors
Wi-Fi	Peer to peer (ad hoc) or infrastructure (network)
SD Card	One card slot for removable SD memory cards
USB	
USB	<ul style="list-style-type: none"> USB-A: Connect external USB device USB Mini-B: Data transfer to and from PC / uncompressed colorized video
USB, standard	USB Mini-B: 2.0

Composite video	
Video out	Composite
Video, standard	CVBS (ITU-R-BT.470 PAL/SMPTE 170M NTSC)
Video, connector type	4-pole 3.5 mm jack
Radio	
Wi-Fi	<ul style="list-style-type: none"> • Standard: 802.11 b/g • Frequency range: 2412–2462 MHz • Max. output power: 15 dBm
METERLiNK/Bluetooth	Frequency range: 2402–2480 MHz
Antenna	Internal
Power system	
Battery type	Rechargeable Li ion battery
Battery voltage	3.7 V
Battery capacity	4.4 Ah, at +20°C to +25°C (+68°F to +77°F)
Battery operating time	Approx. 4 hours at +25°C (+77°F) ambient temperature and typical use
Charging system	In camera (AC adapter or 12 V from a vehicle) or 2-bay charger
Charging time	4 h to 90% capacity, charging status indicated by LED's
Charging temperature	0°C to +45°C (+32°F to +113°F)
Power management	Automatic shutdown and sleep mode (user selectable)
AC operation	AC adapter, 90–260 VAC input, 12 V output to camera
Start-up time from sleep mode	Instant on
Environmental data	
Operating temperature range	–15°C to +50°C (+5°F to +122°F)
Storage temperature range	–40°C to +70°C (–40°F to +158°F)
Humidity (operating and storage)	IEC 60068-2-30/24 h 95% relative humidity +25°C to +40°C (+77°F to +104°F) / 2 cycles
EMC	<ul style="list-style-type: none"> • ETSI EN 301 489-1 (radio) • ETSI EN 301 489-17 • EN 61000-6-2 (Immunity) • EN 61000-6-3 (Emission) • FCC 47 CFR Part 15 B (Emission) • ICES-003
Radio spectrum	<ul style="list-style-type: none"> • ETSI EN 300 328 • FCC Part 15.247 • RSS-210
Magnetic fields	EN 61 000-4-8, Test level 5 for continuous field (severe industrial environment)
Encapsulation	IP 54 (IEC 60529)
Shock	25 g (IEC 60068-2-27)
Vibration	2 g (IEC 60068-2-6)
Safety	EN/UL/CSA/PSE 60950-1

Physical data	
Camera weight, incl. battery	0.855 kg (1.88 lb.)
Camera size (L x W x H)	106 x 201 x 125 mm (4.2 x 7.9 x 4.9 in.), with built-in lens pointing forward
Tripod mounting	UNC ¼"-20 (adapter needed)
Material	<ul style="list-style-type: none"> Polycarbonate + acrylonitrile butadiene styrene (PC-ABS) Thixomold magnesium Thermoplastic elastomer (TPE)
Color	Graphite gray and black
Shipping information	
Packaging, type	Cardboard box
List of contents	<ul style="list-style-type: none"> Infrared camera with lens Battery (2 ea.) Battery charger Bluetooth headset Camera lens cap Calibration certificate Printed documentation Hard transport case Memory card Neckstrap Power supply, incl. multi-plugs Sunshield USB cable Video cable
Packaging, weight	5.7 kg (12.6 lb.)
Packaging, size	495 x 192 x 370 mm (19.49 x 7.56 x 14.57 in.)
EAN-13	7332558006511
UPC-12	845188006860
Country of origin	Sweden

Supplies & accessories:

- 1196961; IR lens, f = 30 mm, 15° incl. case
- 1196960; IR lens, f = 10 mm, 45° incl. case
- T197215; Close-up 4x (100 µm) incl. case
- T197214; Close-up 2x (50 µm) incl. case
- T197408; IR lens, 76 mm (6°) with case and mounting support for T/B-200/400
- T197412; IR lens, 4 mm (90°) with case and mounting support for T/B2xx-4xx
- T197000; High temp. option +1200°C (+2192°F)
- T910814; Power supply, incl. multi plugs
- T197650; 2-bay battery charger, incl. power supply with multi plugs
- 1196398ACC; Battery
- T911230ACC; Memory card SDHC 4 GB
- 1910423; USB cable Std A <-> Mini-B
- T198509; Cigarette lighter adapter kit, 12 VDC, 1.2 m/3.9 ft.
- 1910582ACC; Video cable
- T198370ACC; Hard transport case for FLIR T/B2xx-4xx
- T198495; Pouch for FLIR T6xx and T4xx series
- 1124545; Pouch
- T198493; Sun shield
- T198499; Neck strap
- T197771ACC; Bluetooth Headset
- T911093; Tool belt
- 19250-100; IR Window 2 in
- 19251-100; IR Window 3 in.
- 19252-100; IR Window 4 in.

- 19250-200; SS IR Window 2 in.
- 19251-200; SS IR Window 3 in.
- 19252-200; SS IR Window 4 in.
- T198586; FLIR Reporter Professional (license only)
- T198584; FLIR Tools
- T198583; FLIR Tools+ (download card incl. license key)
- DSW-10000; FLIR IR Camera Player
- APP-10002; FLIR Tools Mobile (Android Application)
- APP-10004; FLIR Tools (MacOS Application)
- T198697; FLIR ResearchIR Max + HSDR 4 (hardware sec. dev.)
- T199014; FLIR ResearchIR Max + HSDR 4 (printed license key)
- T199044; FLIR ResearchIR Max + HSDR 4 Upgrade (printed license key)
- T198696; FLIR ResearchIR Max 4 (hardware sec. dev.)
- T199013; FLIR ResearchIR Max 4 (printed license key)
- T199043; FLIR ResearchIR Max 4 Upgrade (printed license key)
- T198731; FLIR ResearchIR Standard 4 (hardware sec. dev.)
- T199012; FLIR ResearchIR Standard 4 (printed license key)
- T199042; FLIR ResearchIR Standard 4 Upgrade (printed license key)
- T199233; FLIR Atlas SDK for .NET
- T199234; FLIR Atlas SDK for MATLAB

24.11 FLIR T420bx 25° and 15° w/case

P/N: 62103-1503

Rev.: 35936

General description	
The FLIR T420bx is a camera that offers good performance at an affordable price. Excellent ergonomics, a walk-up-and-use interface, and easy communication make the FLIR T420bx a truly user-friendly camera for the beginner or advanced user.	
Benefits:	
<ul style="list-style-type: none"> • Excellent ergonomics: The FLIR T420bx has a tiltable infrared unit and auto-orientation, which make it easy to capture images from any angle comfortably. The small size and low weight of the camera facilitate its use over a full working day. • Affordable performance: The FLIR T420bx is equipped with the innovative Multi Spectral Dynamic Imaging (MSX) feature, which produces an image richer in detail than ever before. You can highlight objects of interest, on both the infrared and the visual image, by sketching or adding predefined stamps directly onto the camera's touch screen. • Extensive communication options: The Wi-Fi connectivity of the FLIR T420bx allows you to connect to smart phones or tablets, for the wireless transfer of images or the remote control of the camera. The Bluetooth-based METERLiNK function transfers readings from external measurement instruments to the infrared image. • Support for UltraMax: When enabling UltraMax in the camera, the resolution of images can be substantially enhanced when importing the images into FLIR Tools. 	
Imaging and optical data	
IR resolution	320 × 240 pixels
MSX resolution	320 × 240 pixels
UltraMax	Yes
Thermal sensitivity/NETD	<30 mK @ +30°C (+86°F)
Field of view (FOV)	25° × 19°
Minimum focus distance	0.4 m (1.31 ft.)
Focal length	18 mm (0.7 in.)
Spatial resolution (IFOV)	1.36 mrad
F-number	1.3
Image frequency	60 Hz
Focus	Automatic (one shot) or manual
Digital zoom	2× and 4×
Detector data	
Detector type	Focal plane array (FPA), uncooled microbolometer
Spectral range	7.5–13 μm
Detector pitch	25 μm
Image presentation	
Display	Touch screen, 3.5 in. LCD, 320 × 240 pixels
Auto orientation	Automatic landscape or portrait
Image adjustment	Auto or manual
Image presentation modes	
Thermal MSX	Thermal image with enhanced detail presentation
Picture in Picture	Resizable and movable IR area on visual image

Measurement	
Object temperature range	<ul style="list-style-type: none"> • -20°C to +120°C (-4°F to +248°F) • 0°C to +350°C (+32°F to +662°F)
Accuracy	±2°C (±3.6°F) or 2%, whichever is greater, at 25°C (77°F) nominal.
Measurement analysis	
Spotmeter	5
Area	5 + 5 areas (boxes or circles) with max./min./average (in post-acquisition analysis)
Automatic hot/cold detection	Auto hot or cold spotmeter markers within area
Measurement presets	No measurements, Center spot, Hot spot, Cold spot, 3 spots, Hotspot-spot, Hotspot-temperature
Difference temperature	Delta temperature between measurement functions or reference temperature
Reference temperature	Manually set using difference temperature
Emissivity correction	Variable from 0.01 to 1.0 or selected from materials list
Measurement corrections	Emissivity, reflected temperature, relative humidity, atmospheric temperature, object distance, external IR window compensation
Colors (palettes)	Iron, Rainbow, Rainbow HC, White hot, Black hot, Arctic, Lava
Alarm	
Color Alarm (isotherm)	Above/below/interval
Measurement function alarm	Audible/visual alarms (above/below) on any selected measurement function
Screening	Difference temperature alarm, audible
Humidity alarm	1 humidity alarm, including dew point alarm
Insulation alarm	1 insulation alarm
Set-up	
Set-up commands	Save options, Programmable button, Reset options, Set up camera, Wi-Fi, Compass, Bluetooth, Language, Time & units, Camera information
Service functions	
Camera software update	Use PC software FLIR Tools
Storage of images	
Image storage	Standard JPEG, including digital photo and measurement data, on memory card
Image storage mode	<ul style="list-style-type: none"> • Simultaneous storage of thermal and digital photo in same JPEG file. • Optional to store digital photo as a separate JPEG file.
Time lapse	15 seconds to 24 hours
Image annotations (in still images)	
Voice	60 seconds (via Bluetooth) stored with the image
Text	Add table. Select between predefined templates or create your own in FLIR Tools
Image description	Add short note (stored in JPEG EXIF tag)

Image annotations (in still images)	
METERLiNK	Wireless connection (Bluetooth) to: FLIR meters with METERLiNK
Report generation	<ul style="list-style-type: none"> Instant Report (*.pdf file) in camera including IR and visual images Separate PC software with extensive report generation
Geographic Information System	
Compass	Camera direction automatically added to every still image
Video recording in camera	
Non-radiometric IR video recording	MPEG-4 to memory card
Visual video recording	MPEG-4 to memory card
Video streaming	
Radiometric IR video streaming	Full dynamic to PC using USB or to mobile devices using Wi-Fi.
Non-radiometric IR video streaming	<ul style="list-style-type: none"> MPEG-4 using Wi-Fi Uncompressed colorized video using USB
Visual video streaming	<ul style="list-style-type: none"> MPEG-4 using Wi-Fi Uncompressed colorized video using USB
Digital camera	
Built-in digital camera	3.1 Mpixels with LED light (photo as separate image)
Digital camera, focus	Fixed focus
Digital camera, FOV	Adapts to the IR lens
Built-in digital lens data	FOV 53° × 41°
Digital camera, aspect ratio	4:3
Laser pointer	
Laser	Activated by dedicated button
Laser alignment	Position is automatic displayed on the IR image
Laser classification	Class 2
Laser type	Semiconductor AlGaInP diode laser
Laser power	1 mW
Laser wavelength	635 nm (red)
Data communication interfaces	
Interfaces	USB-mini, USB-A, Bluetooth, Wi-Fi, composite video
METERLiNK/Bluetooth	Communication with headset and external sensors
Wi-Fi	Peer to peer (ad hoc) or infrastructure (network)
SD Card	One card slot for removable SD memory cards
USB	
USB	<ul style="list-style-type: none"> USB-A: Connect external USB device USB Mini-B: Data transfer to and from PC / uncompressed colorized video
USB, standard	USB Mini-B: 2.0

Composite video	
Video out	Composite
Video, standard	CVBS (ITU-R-BT.470 PAL/SMPTE 170M NTSC)
Video, connector type	4-pole 3.5 mm jack
Radio	
Wi-Fi	<ul style="list-style-type: none"> • Standard: 802.11 b/g • Frequency range: 2412–2462 MHz • Max. output power: 15 dBm
METERLiNK/Bluetooth	Frequency range: 2402–2480 MHz
Antenna	Internal
Power system	
Battery type	Rechargeable Li ion battery
Battery voltage	3.7 V
Battery capacity	4.4 Ah, at +20°C to +25°C (+68°F to +77°F)
Battery operating time	Approx. 4 hours at +25°C (+77°F) ambient temperature and typical use
Charging system	In camera (AC adapter or 12 V from a vehicle) or 2-bay charger
Charging time	4 h to 90% capacity, charging status indicated by LED's
Charging temperature	0°C to +45°C (+32°F to +113°F)
Power management	Automatic shutdown and sleep mode (user selectable)
AC operation	AC adapter, 90–260 VAC input, 12 V output to camera
Start-up time from sleep mode	Instant on
Environmental data	
Operating temperature range	–15°C to +50°C (+5°F to +122°F)
Storage temperature range	–40°C to +70°C (–40°F to +158°F)
Humidity (operating and storage)	IEC 60068-2-30/24 h 95% relative humidity +25°C to +40°C (+77°F to +104°F) / 2 cycles
EMC	<ul style="list-style-type: none"> • ETSI EN 301 489-1 (radio) • ETSI EN 301 489-17 • EN 61000-6-2 (Immunity) • EN 61000-6-3 (Emission) • FCC 47 CFR Part 15 B (Emission) • ICES-003
Radio spectrum	<ul style="list-style-type: none"> • ETSI EN 300 328 • FCC Part 15.247 • RSS-210
Magnetic fields	EN 61 000-4-8, Test level 5 for continuous field (severe industrial environment)
Encapsulation	IP 54 (IEC 60529)
Shock	25 g (IEC 60068-2-27)
Vibration	2 g (IEC 60068-2-6)
Safety	EN/UL/CSA/PSE 60950-1

Physical data	
Camera weight, incl. battery	0.855 kg (1.88 lb.)
Camera size (L × W × H)	106 × 201 × 125 mm (4.2 × 7.9 × 4.9 in.), with built-in lens pointing forward
Tripod mounting	UNC ¼"-20 (adapter needed)
Material	<ul style="list-style-type: none"> Polycarbonate + acrylonitrile butadiene styrene (PC-ABS) Thixomold magnesium Thermoplastic elastomer (TPE)
Color	Graphite gray and black
Shipping information	
Packaging, type	Cardboard box
List of contents	<ul style="list-style-type: none"> Infrared camera with lens Battery (2 ea.) Battery charger Bluetooth headset Camera lens cap Calibration certificate Hard transport case IR lens, f = 30 mm, 15° Memory card Neckstrap Power supply, incl. multi-plugs Printed documentation Sunshield USB cable Video cable
EAN-13	7332558012154
UPC-12	845188013257
Country of origin	Sweden

Supplies & accessories:

- 1196961; IR lens, f = 30 mm, 15° incl. case
- 1196960; IR lens, f = 10 mm, 45° incl. case
- T197215; Close-up 4× (100 µm) incl. case
- T197214; Close-up 2× (50 µm) incl. case
- T197408; IR lens, 76 mm (6°) with case and mounting support for T/B-200/400
- T197412; IR lens, 4 mm (90°) with case and mounting support for T/B2xx-4xx
- T197000; High temp. option +1200°C (+2192°F)
- T910814; Power supply, incl. multi plugs
- T197650; 2-bay battery charger, incl. power supply with multi plugs
- 1196398ACC; Battery
- T911230ACC; Memory card SDHC 4 GB
- 1910423; USB cable Std A <-> Mini-B
- T198509; Cigarette lighter adapter kit, 12 VDC, 1.2 m/3.9 ft.
- 1910582ACC; Video cable
- T198370ACC; Hard transport case for FLIR T/B2xx-4xx
- T198495; Pouch for FLIR T6xx and T4xx series
- 1124545; Pouch
- T198493; Sun shield
- T198499; Neck strap
- T197771ACC; Bluetooth Headset
- T911093; Tool belt
- 19250-100; IR Window 2 in
- 19251-100; IR Window 3 in.
- 19252-100; IR Window 4 in.
- 19250-200; SS IR Window 2 in.
- 19251-200; SS IR Window 3 in.

- 19252-200; SS IR Window 4 in.
- T198586; FLIR Reporter Professional (license only)
- T198584; FLIR Tools
- T198583; FLIR Tools+ (download card incl. license key)
- DSW-10000; FLIR IR Camera Player
- APP-10002; FLIR Tools Mobile (Android Application)
- APP-10004; FLIR Tools (MacOS Application)
- T198697; FLIR ResearchIR Max + HSDR 4 (hardware sec. dev.)
- T199014; FLIR ResearchIR Max + HSDR 4 (printed license key)
- T199044; FLIR ResearchIR Max + HSDR 4 Upgrade (printed license key)
- T198696; FLIR ResearchIR Max 4 (hardware sec. dev.)
- T199013; FLIR ResearchIR Max 4 (printed license key)
- T199043; FLIR ResearchIR Max 4 Upgrade (printed license key)
- T198731; FLIR ResearchIR Standard 4 (hardware sec. dev.)
- T199012; FLIR ResearchIR Standard 4 (printed license key)
- T199042; FLIR ResearchIR Standard 4 Upgrade (printed license key)
- T199233; FLIR Atlas SDK for .NET
- T199234; FLIR Atlas SDK for MATLAB

24.12 FLIR T420bx 25° and 45° w/case

P/N: 62103-1504

Rev.: 35937

General description	
The FLIR T420bx is a camera that offers good performance at an affordable price. Excellent ergonomics, a walk-up-and-use interface, and easy communication make the FLIR T420bx a truly user-friendly camera for the beginner or advanced user.	
Benefits:	
<ul style="list-style-type: none"> • Excellent ergonomics: The FLIR T420bx has a tiltable infrared unit and auto-orientation, which make it easy to capture images from any angle comfortably. The small size and low weight of the camera facilitate its use over a full working day. • Affordable performance: The FLIR T420bx is equipped with the innovative Multi Spectral Dynamic Imaging (MSX) feature, which produces an image richer in detail than ever before. You can highlight objects of interest, on both the infrared and the visual image, by sketching or adding predefined stamps directly onto the camera's touch screen. • Extensive communication options: The Wi-Fi connectivity of the FLIR T420bx allows you to connect to smart phones or tablets, for the wireless transfer of images or the remote control of the camera. The Bluetooth-based METERLiNK function transfers readings from external measurement instruments to the infrared image. • Support for UltraMax: When enabling UltraMax in the camera, the resolution of images can be substantially enhanced when importing the images into FLIR Tools. 	
Imaging and optical data	
IR resolution	320 × 240 pixels
MSX resolution	320 × 240 pixels
UltraMax	Yes
Thermal sensitivity/NETD	<30 mK @ +30°C (+86°F)
Field of view (FOV)	25° × 19°
Minimum focus distance	0.4 m (1.31 ft.)
Focal length	18 mm (0.7 in.)
Spatial resolution (IFOV)	1.36 mrad
F-number	1.3
Image frequency	60 Hz
Focus	Automatic (one shot) or manual
Digital zoom	2× and 4×
Detector data	
Detector type	Focal plane array (FPA), uncooled microbolometer
Spectral range	7.5–13 μm
Detector pitch	25 μm
Image presentation	
Display	Touch screen, 3.5 in. LCD, 320 × 240 pixels
Auto orientation	Automatic landscape or portrait
Image adjustment	Auto or manual
Image presentation modes	
Thermal MSX	Thermal image with enhanced detail presentation
Picture in Picture	Resizable and movable IR area on visual image

Measurement	
Object temperature range	<ul style="list-style-type: none"> • -20°C to +120°C (-4°F to +248°F) • 0°C to +350°C (+32°F to +662°F)
Accuracy	±2°C (±3.6°F) or 2%, whichever is greater, at 25°C (77°F) nominal.
Measurement analysis	
Spotmeter	5
Area	5 + 5 areas (boxes or circles) with max./min./average (in post-acquisition analysis)
Automatic hot/cold detection	Auto hot or cold spotmeter markers within area
Measurement presets	No measurements, Center spot, Hot spot, Cold spot, 3 spots, Hotspot-spot, Hotspot-temperature
Difference temperature	Delta temperature between measurement functions or reference temperature
Reference temperature	Manually set using difference temperature
Emissivity correction	Variable from 0.01 to 1.0 or selected from materials list
Measurement corrections	Emissivity, reflected temperature, relative humidity, atmospheric temperature, object distance, external IR window compensation
Colors (palettes)	Iron, Rainbow, Rainbow HC, White hot, Black hot, Arctic, Lava
Alarm	
Color Alarm (isotherm)	Above/below/interval
Measurement function alarm	Audible/visual alarms (above/below) on any selected measurement function
Screening	Difference temperature alarm, audible
Humidity alarm	1 humidity alarm, including dew point alarm
Insulation alarm	1 insulation alarm
Set-up	
Set-up commands	Save options, Programmable button, Reset options, Set up camera, Wi-Fi, Compass, Bluetooth, Language, Time & units, Camera information
Service functions	
Camera software update	Use PC software FLIR Tools
Storage of images	
Image storage	Standard JPEG, including digital photo and measurement data, on memory card
Image storage mode	<ul style="list-style-type: none"> • Simultaneous storage of thermal and digital photo in same JPEG file. • Optional to store digital photo as a separate JPEG file.
Time lapse	15 seconds to 24 hours
Image annotations (in still images)	
Voice	60 seconds (via Bluetooth) stored with the image
Text	Add table. Select between predefined templates or create your own in FLIR Tools
Image description	Add short note (stored in JPEG EXIF tag)

Image annotations (in still images)	
METERLiNK	Wireless connection (Bluetooth) to: FLIR meters with METERLiNK
Report generation	<ul style="list-style-type: none"> Instant Report (*.pdf file) in camera including IR and visual images Separate PC software with extensive report generation
Geographic Information System	
Compass	Camera direction automatically added to every still image
Video recording in camera	
Non-radiometric IR video recording	MPEG-4 to memory card
Visual video recording	MPEG-4 to memory card
Video streaming	
Radiometric IR video streaming	Full dynamic to PC using USB or to mobile devices using Wi-Fi.
Non-radiometric IR video streaming	<ul style="list-style-type: none"> MPEG-4 using Wi-Fi Uncompressed colorized video using USB
Visual video streaming	<ul style="list-style-type: none"> MPEG-4 using Wi-Fi Uncompressed colorized video using USB
Digital camera	
Built-in digital camera	3.1 Mpixels with LED light (photo as separate image)
Digital camera, focus	Fixed focus
Digital camera, FOV	Adapts to the IR lens
Built-in digital lens data	FOV 53° × 41°
Digital camera, aspect ratio	4:3
Laser pointer	
Laser	Activated by dedicated button
Laser alignment	Position is automatic displayed on the IR image
Laser classification	Class 2
Laser type	Semiconductor AlGaInP diode laser
Laser power	1 mW
Laser wavelength	635 nm (red)
Data communication interfaces	
Interfaces	USB-mini, USB-A, Bluetooth, Wi-Fi, composite video
METERLiNK/Bluetooth	Communication with headset and external sensors
Wi-Fi	Peer to peer (ad hoc) or infrastructure (network)
SD Card	One card slot for removable SD memory cards
USB	
USB	<ul style="list-style-type: none"> USB-A: Connect external USB device USB Mini-B: Data transfer to and from PC / uncompressed colorized video
USB, standard	USB Mini-B: 2.0

Composite video	
Video out	Composite
Video, standard	CVBS (ITU-R-BT.470 PAL/SMPTE 170M NTSC)
Video, connector type	4-pole 3.5 mm jack
Radio	
Wi-Fi	<ul style="list-style-type: none"> • Standard: 802.11 b/g • Frequency range: 2412–2462 MHz • Max. output power: 15 dBm
METERLiNK/Bluetooth	Frequency range: 2402–2480 MHz
Antenna	Internal
Power system	
Battery type	Rechargeable Li ion battery
Battery voltage	3.7 V
Battery capacity	4.4 Ah, at +20°C to +25°C (+68°F to +77°F)
Battery operating time	Approx. 4 hours at +25°C (+77°F) ambient temperature and typical use
Charging system	In camera (AC adapter or 12 V from a vehicle) or 2-bay charger
Charging time	4 h to 90% capacity, charging status indicated by LED's
Charging temperature	0°C to +45°C (+32°F to +113°F)
Power management	Automatic shutdown and sleep mode (user selectable)
AC operation	AC adapter, 90–260 VAC input, 12 V output to camera
Start-up time from sleep mode	Instant on
Environmental data	
Operating temperature range	–15°C to +50°C (+5°F to +122°F)
Storage temperature range	–40°C to +70°C (–40°F to +158°F)
Humidity (operating and storage)	IEC 60068-2-30/24 h 95% relative humidity +25°C to +40°C (+77°F to +104°F) / 2 cycles
EMC	<ul style="list-style-type: none"> • ETSI EN 301 489-1 (radio) • ETSI EN 301 489-17 • EN 61000-6-2 (Immunity) • EN 61000-6-3 (Emission) • FCC 47 CFR Part 15 B (Emission) • ICES-003
Radio spectrum	<ul style="list-style-type: none"> • ETSI EN 300 328 • FCC Part 15.247 • RSS-210
Magnetic fields	EN 61 000-4-8, Test level 5 for continuous field (severe industrial environment)
Encapsulation	IP 54 (IEC 60529)
Shock	25 g (IEC 60068-2-27)
Vibration	2 g (IEC 60068-2-6)
Safety	EN/UL/CSA/PSE 60950-1

Physical data	
Camera weight, incl. battery	0.855 kg (1.88 lb.)
Camera size (L × W × H)	106 × 201 × 125 mm (4.2 × 7.9 × 4.9 in.), with built-in lens pointing forward
Tripod mounting	UNC ¼"-20 (adapter needed)
Material	<ul style="list-style-type: none"> Polycarbonate + acrylonitrile butadiene styrene (PC-ABS) Thixomold magnesium Thermoplastic elastomer (TPE)
Color	Graphite gray and black
Shipping information	
Packaging, type	Cardboard box
List of contents	<ul style="list-style-type: none"> Infrared camera with lens Battery (2 ea.) Battery charger Bluetooth headset Camera lens cap Calibration certificate Hard transport case IR lens, f = 10 mm, 45° Memory card Neckstrap Power supply, incl. multi-plugs Printed documentation Sunshield USB cable Video cable
EAN-13	7332558012161
UPC-12	845188013264
Country of origin	Sweden

Supplies & accessories:

- 1196961; IR lens, f = 30 mm, 15° incl. case
- 1196960; IR lens, f = 10 mm, 45° incl. case
- T197215; Close-up 4× (100 µm) incl. case
- T197214; Close-up 2× (50 µm) incl. case
- T197408; IR lens, 76 mm (6°) with case and mounting support for T/B-200/400
- T197412; IR lens, 4 mm (90°) with case and mounting support for T/B2xx-4xx
- T197000; High temp. option +1200°C (+2192°F)
- T910814; Power supply, incl. multi plugs
- T197650; 2-bay battery charger, incl. power supply with multi plugs
- 1196398ACC; Battery
- T911230ACC; Memory card SDHC 4 GB
- 1910423; USB cable Std A <-> Mini-B
- T198509; Cigarette lighter adapter kit, 12 VDC, 1.2 m/3.9 ft.
- 1910582ACC; Video cable
- T198370ACC; Hard transport case for FLIR T/B2xx-4xx
- T198495; Pouch for FLIR T6xx and T4xx series
- 1124545; Pouch
- T198493; Sun shield
- T198499; Neck strap
- T197771ACC; Bluetooth Headset
- T911093; Tool belt
- 19250-100; IR Window 2 in
- 19251-100; IR Window 3 in.
- 19252-100; IR Window 4 in.
- 19250-200; SS IR Window 2 in.
- 19251-200; SS IR Window 3 in.

- 19252-200; SS IR Window 4 in.
- T198586; FLIR Reporter Professional (license only)
- T198584; FLIR Tools
- T198583; FLIR Tools+ (download card incl. license key)
- DSW-10000; FLIR IR Camera Player
- APP-10002; FLIR Tools Mobile (Android Application)
- APP-10004; FLIR Tools (MacOS Application)
- T198697; FLIR ResearchIR Max + HSDR 4 (hardware sec. dev.)
- T199014; FLIR ResearchIR Max + HSDR 4 (printed license key)
- T199044; FLIR ResearchIR Max + HSDR 4 Upgrade (printed license key)
- T198696; FLIR ResearchIR Max 4 (hardware sec. dev.)
- T199013; FLIR ResearchIR Max 4 (printed license key)
- T199043; FLIR ResearchIR Max 4 Upgrade (printed license key)
- T198731; FLIR ResearchIR Standard 4 (hardware sec. dev.)
- T199012; FLIR ResearchIR Standard 4 (printed license key)
- T199042; FLIR ResearchIR Standard 4 Upgrade (printed license key)
- T199233; FLIR Atlas SDK for .NET
- T199234; FLIR Atlas SDK for MATLAB

24.13 FLIR T430sc (incl. Wi-Fi)

P/N: 62104-2203

Rev.: 35207

General description	
<p>The FLIR T430sc is a camera that offers good performance at an affordable price. Excellent ergonomics and a walk-up-and-use interface make the FLIR T430sc a truly user-friendly camera for the beginner or advanced user. High accuracy and sensitivity together with radiometric streaming options make the FLIR T430sc well suited for research and development.</p>	
Benefits:	
<ul style="list-style-type: none"> • Tailor made for research and development: The FLIR T430sc has high accuracy and sensitivity to accurately measure the smallest temperature differences. • Excellent ergonomics: The FLIR T430sc has a tiltable infrared unit and auto-orientation, which make it easy to capture images from any angle comfortably. The small size and low weight of the camera facilitate its use over a full working day. • Affordable performance: The FLIR T430sc is equipped with the innovative Multi Spectral Dynamic Imaging (MSX) feature, which produces an image richer in detail than ever before. You can highlight objects of interest, on both the infrared and visual images, by sketching or adding predefined stamps directly onto the camera's touch screen. • Extensive communication options: The Wi-Fi connectivity of the FLIR T430sc allows you to connect to smart phones or tablets for the wireless transfer of images or the remote control of the camera. The Bluetooth-based METERLINK function transfers readings from external measurement instruments to the infrared image. • Support for UltraMax: When enabling UltraMax in the camera, the resolution of images can be substantially enhanced when importing the images into FLIR Tools. 	
Imaging and optical data	
IR resolution	320 × 240 pixels
MSX resolution	320 × 240 pixels
UltraMax	Yes
Thermal sensitivity/NETD	<30 mK @ +30°C (+86°F)
Field of view (FOV)	25° × 19°
Minimum focus distance	0.4 m (1.31 ft.)
Focal length	18 mm (0.7 in.)
Spatial resolution (IFOV)	1.36 mrad
F-number	1.3
Image frequency	60 Hz
Focus	Automatic (one shot) or manual
Digital zoom	2× and 4×
Detector data	
Detector type	Focal plane array (FPA), uncooled microbolometer
Spectral range	7.5–13 μm
Detector pitch	25 μm
Image presentation	
Display	Touch screen, 3.5 in. LCD, 320 × 240 pixels
Auto orientation	Automatic landscape or portrait
Image adjustment	Auto or manual
Image presentation modes	
Thermal MSX	Thermal image with enhanced detail presentation
Picture in Picture	Resizable and movable IR area on visual image

Measurement	
Object temperature range	<ul style="list-style-type: none"> • -20°C to +120°C (-4°F to +248°F) • 0°C to +650°C (+32°F to +1202°F)
Accuracy	±2°C (±3.6°F) or 2%, whichever is greater, at 25°C (77°F) nominal.
Measurement analysis	
Spotmeter	5
Area	5 + 5 areas (boxes or circles) with max./min./average (in post-acquisition analysis)
Automatic hot/cold detection	Auto hot or cold spotmeter markers within area
Measurement presets	No measurements, Center spot, Hot spot, Cold spot, 3 spots, Hotspot-spot, Hotspot-temperature
Difference temperature	Delta temperature between measurement functions or reference temperature
Reference temperature	Manually set using difference temperature
Emissivity correction	Variable from 0.01 to 1.0 or selected from materials list
Measurement corrections	Emissivity, reflected temperature, relative humidity, atmospheric temperature, object distance, external IR window compensation
Colors (palettes)	Iron, Rainbow, Rainbow HC, White hot, Black hot, Arctic, Lava
Alarm	
Color Alarm (isotherm)	Above/below/interval
Measurement function alarm	Audible/visual alarms (above/below) on any selected measurement function
Screening	Difference temperature alarm, audible
Humidity alarm	1 humidity alarm, including dew point alarm
Insulation alarm	1 insulation alarm
Set-up	
Set-up commands	Save options, Programmable button, Reset options, Set up camera, Wi-Fi, Compass, Bluetooth, Language, Time & units, Camera information
Service functions	
Camera software update	Use PC software FLIR Tools
Storage of images	
Image storage	Standard JPEG, including digital photo and measurement data, on memory card
Image storage mode	<ul style="list-style-type: none"> • Simultaneous storage of thermal and digital photo in same JPEG file. • Optional to store digital photo as a separate JPEG file.
Time lapse	15 seconds to 24 hours
Image annotations (in still images)	
Voice	60 seconds (via Bluetooth) stored with the image
Text	Add table. Select between predefined templates or create your own in FLIR Tools
Image description	Add short note (stored in JPEG EXIF tag)

Image annotations (in still images)	
METERLiNK	Wireless connection (Bluetooth) to: FLIR meters with METERLiNK
Report generation	<ul style="list-style-type: none"> Instant Report (*.pdf file) in camera including IR and visual images Separate PC software with extensive report generation
Geographic Information System	
Compass	Camera direction automatically added to every still image
Video recording in camera	
Non-radiometric IR video recording	MPEG-4 to memory card
Visual video recording	MPEG-4 to memory card
Video streaming	
Radiometric IR video streaming	Full dynamic to PC using USB or to mobile devices using Wi-Fi.
Non-radiometric IR video streaming	<ul style="list-style-type: none"> MPEG-4 using Wi-Fi Uncompressed colorized video using USB
Visual video streaming	<ul style="list-style-type: none"> MPEG-4 using Wi-Fi Uncompressed colorized video using USB
Digital camera	
Built-in digital camera	3.1 Mpixels with LED light (photo as separate image)
Digital camera, focus	Fixed focus
Digital camera, FOV	Adapts to the IR lens
Built-in digital lens data	FOV 53° × 41°
Digital camera, aspect ratio	4:3
Laser pointer	
Laser	Activated by dedicated button
Laser alignment	Position is automatic displayed on the IR image
Laser classification	Class 2
Laser type	Semiconductor AlGaInP diode laser
Laser power	1 mW
Laser wavelength	635 nm (red)
Data communication interfaces	
Interfaces	USB-mini, USB-A, Bluetooth, Wi-Fi, composite video
METERLiNK/Bluetooth	Communication with headset and external sensors
Wi-Fi	Peer to peer (ad hoc) or infrastructure (network)
SD Card	One card slot for removable SD memory cards
USB	
USB	<ul style="list-style-type: none"> USB-A: Connect external USB device USB Mini-B: Data transfer to and from PC / uncompressed colorized video
USB, standard	USB Mini-B: 2.0

Composite video	
Video out	Composite
Video, standard	CVBS (ITU-R-BT.470 PAL/SMPTE 170M NTSC)
Video, connector type	4-pole 3.5 mm jack
Radio	
Wi-Fi	<ul style="list-style-type: none"> Standard: 802.11 b/g Frequency range: 2412–2462 MHz Max. output power: 15 dBm
METERLiNK/Bluetooth	Frequency range: 2402–2480 MHz
Antenna	Internal
Power system	
Battery type	Rechargeable Li ion battery
Battery voltage	3.7 V
Battery capacity	4.4 Ah, at +20°C to +25°C (+68°F to +77°F)
Battery operating time	Approx. 4 hours at +25°C (+77°F) ambient temperature and typical use
Charging system	In camera (AC adapter or 12 V from a vehicle) or 2-bay charger
Charging time	4 h to 90% capacity, charging status indicated by LED's
Charging temperature	0°C to +45°C (+32°F to +113°F)
Power management	Automatic shutdown and sleep mode (user selectable)
AC operation	AC adapter, 90–260 VAC input, 12 V output to camera
Start-up time from sleep mode	Instant on
Environmental data	
Operating temperature range	–15°C to +50°C (+5°F to +122°F)
Storage temperature range	–40°C to +70°C (–40°F to +158°F)
Humidity (operating and storage)	IEC 60068-2-30/24 h 95% relative humidity +25°C to +40°C (+77°F to +104°F) / 2 cycles
EMC	<ul style="list-style-type: none"> ETSI EN 301 489-1 (radio) ETSI EN 301 489-17 EN 61000-6-2 (Immunity) EN 61000-6-3 (Emission) FCC 47 CFR Part 15 B (Emission) ICES-003
Radio spectrum	<ul style="list-style-type: none"> ETSI EN 300 328 FCC Part 15.247 RSS-210
Magnetic fields	EN 61 000-4-8, Test level 5 for continuous field (severe industrial environment)
Encapsulation	IP 54 (IEC 60529)
Shock	25 g (IEC 60068-2-27)
Vibration	2 g (IEC 60068-2-6)
Safety	EN/UL/CSA/PSE 60950-1

Physical data	
Camera weight, incl. battery	0.855 kg (1.88 lb.)
Camera size (L × W × H)	106 × 201 × 125 mm (4.2 × 7.9 × 4.9 in.), with built-in lens pointing forward
Tripod mounting	UNC ¼"-20 (adapter needed)
Material	<ul style="list-style-type: none"> • Polycarbonate + acrylonitrile butadiene styrene (PC-ABS) • Thixomold magnesium • Thermoplastic elastomer (TPE)
Color	Graphite gray and black
Shipping information	
Packaging, type	Cardboard box
List of contents	<ul style="list-style-type: none"> • Infrared camera with lens • Battery (2 ea.) • Battery charger • Bluetooth headset • Camera lens cap • Calibration certificate • FLIR ResearchIR Max 4 • Printed documentation • Hard transport case • Memory card • Neckstrap • Power supply, incl. multi-plugs • Sunshield • USB cable • Video cable
Packaging, weight	
Packaging, size	495 × 192 × 370 mm (19.49 × 7.56 × 14.57 in.)
EAN-13	7332558008690
UPC-12	845188009212
Country of origin	Sweden

Supplies & accessories:

- 1196961; IR lens, f = 30 mm, 15° incl. case
- 1196960; IR lens, f = 10 mm, 45° incl. case
- T197215; Close-up 4× (100 µm) incl. case
- T197214; Close-up 2× (50 µm) incl. case
- T197408; IR lens, 76 mm (6°) with case and mounting support for T/B-200/400
- T197412; IR lens, 4 mm (90°) with case and mounting support for T/B2xx-4xx
- T197000; High temp. option +1200°C (+2192°F)
- T910814; Power supply, incl. multi plugs
- T197650; 2-bay battery charger, incl. power supply with multi plugs
- 1196398ACC; Battery
- T911230ACC; Memory card SDHC 4 GB
- 1910423; USB cable Std A <-> Mini-B
- T198509; Cigarette lighter adapter kit, 12 VDC, 1.2 m/3.9 ft.
- 1910582ACC; Video cable
- T198370ACC; Hard transport case for FLIR T/B2xx-4xx
- T198495; Pouch for FLIR T6xx and T4xx series
- 1124545; Pouch
- T198493; Sun shield
- T198499; Neck strap
- T197771ACC; Bluetooth Headset
- T911093; Tool belt
- 19250-100; IR Window 2 in
- 19251-100; IR Window 3 in.

- 19252-100; IR Window 4 in.
- 19250-200; SS IR Window 2 in.
- 19251-200; SS IR Window 3 in.
- 19252-200; SS IR Window 4 in.
- T198586; FLIR Reporter Professional (license only)
- T198584; FLIR Tools
- T198583; FLIR Tools+ (download card incl. license key)
- DSW-10000; FLIR IR Camera Player
- APP-10002; FLIR Tools Mobile (Android Application)
- APP-10004; FLIR Tools (MacOS Application)
- T198697; FLIR ResearchIR Max + HSDR 4 (hardware sec. dev.)
- T199014; FLIR ResearchIR Max + HSDR 4 (printed license key)
- T199044; FLIR ResearchIR Max + HSDR 4 Upgrade (printed license key)
- T198696; FLIR ResearchIR Max 4 (hardware sec. dev.)
- T199013; FLIR ResearchIR Max 4 (printed license key)
- T199043; FLIR ResearchIR Max 4 Upgrade (printed license key)
- T198731; FLIR ResearchIR Standard 4 (hardware sec. dev.)
- T199012; FLIR ResearchIR Standard 4 (printed license key)
- T199042; FLIR ResearchIR Standard 4 Upgrade (printed license key)
- T199233; FLIR Atlas SDK for .NET
- T199234; FLIR Atlas SDK for MATLAB

24.14 FLIR T430sc with SC kit (incl. Wi-Fi)

P/N: 62104-2204

Rev.: 35207

General description	
<p>The FLIR T430sc is a camera that offers good performance at an affordable price. Excellent ergonomics and a walk-up-and-use interface make the FLIR T430sc a truly user-friendly camera for the beginner or advanced user. High accuracy and sensitivity together with radiometric streaming options make the FLIR T430sc well suited for research and development.</p>	
Benefits:	
<ul style="list-style-type: none"> • Tailor made for research and development: The FLIR T430sc has high accuracy and sensitivity to accurately measure the smallest temperature differences. • Excellent ergonomics: The FLIR T430sc has a tiltable infrared unit and auto-orientation, which make it easy to capture images from any angle comfortably. The small size and low weight of the camera facilitate its use over a full working day. • Affordable performance: The FLIR T430sc is equipped with the innovative Multi Spectral Dynamic Imaging (MSX) feature, which produces an image richer in detail than ever before. You can highlight objects of interest, on both the infrared and visual images, by sketching or adding predefined stamps directly onto the camera's touch screen. • Extensive communication options: The Wi-Fi connectivity of the FLIR T430sc allows you to connect to smart phones or tablets for the wireless transfer of images or the remote control of the camera. The Bluetooth-based METERLiNK function transfers readings from external measurement instruments to the infrared image. • Support for UltraMax: When enabling UltraMax in the camera, the resolution of images can be substantially enhanced when importing the images into FLIR Tools. 	
Imaging and optical data	
IR resolution	320 × 240 pixels
MSX resolution	320 × 240 pixels
UltraMax	Yes
Thermal sensitivity/NETD	<30 mK @ +30°C (+86°F)
Field of view (FOV)	25° × 19°
Minimum focus distance	0.4 m (1.31 ft.)
Focal length	18 mm (0.7 in.)
Spatial resolution (IFOV)	1.36 mrad
F-number	1.3
Image frequency	60 Hz
Focus	Automatic (one shot) or manual
Digital zoom	2× and 4×
Detector data	
Detector type	Focal plane array (FPA), uncooled microbolometer
Spectral range	7.5–13 μm
Detector pitch	25 μm
Image presentation	
Display	Touch screen, 3.5 in. LCD, 320 × 240 pixels
Auto orientation	Automatic landscape or portrait
Image adjustment	Auto or manual
Image presentation modes	
Thermal MSX	Thermal image with enhanced detail presentation
Picture in Picture	Resizable and movable IR area on visual image

Measurement	
Object temperature range	<ul style="list-style-type: none"> • -20°C to +120°C (-4°F to +248°F) • 0°C to +650°C (+32°F to +1202°F)
Accuracy	±2°C (±3.6°F) or 2%, whichever is greater, at 25°C (77°F) nominal.
Measurement analysis	
Spotmeter	5
Area	5 + 5 areas (boxes or circles) with max./min./average (in post-acquisition analysis)
Automatic hot/cold detection	Auto hot or cold spotmeter markers within area
Measurement presets	No measurements, Center spot, Hot spot, Cold spot, 3 spots, Hotspot-spot, Hotspot-temperature
Difference temperature	Delta temperature between measurement functions or reference temperature
Reference temperature	Manually set using difference temperature
Emissivity correction	Variable from 0.01 to 1.0 or selected from materials list
Measurement corrections	Emissivity, reflected temperature, relative humidity, atmospheric temperature, object distance, external IR window compensation
Colors (palettes)	Iron, Rainbow, Rainbow HC, White hot, Black hot, Arctic, Lava
Alarm	
Color Alarm (isotherm)	Above/below/interval
Measurement function alarm	Audible/visual alarms (above/below) on any selected measurement function
Screening	Difference temperature alarm, audible
Humidity alarm	1 humidity alarm, including dew point alarm
Insulation alarm	1 insulation alarm
Set-up	
Set-up commands	Save options, Programmable button, Reset options, Set up camera, Wi-Fi, Compass, Bluetooth, Language, Time & units, Camera information
Service functions	
Camera software update	Use PC software FLIR Tools
Storage of images	
Image storage	Standard JPEG, including digital photo and measurement data, on memory card
Image storage mode	<ul style="list-style-type: none"> • Simultaneous storage of thermal and digital photo in same JPEG file. • Optional to store digital photo as a separate JPEG file.
Time lapse	15 seconds to 24 hours
Image annotations (in still images)	
Voice	60 seconds (via Bluetooth) stored with the image
Text	Add table. Select between predefined templates or create your own in FLIR Tools
Image description	Add short note (stored in JPEG EXIF tag)

Image annotations (in still images)	
METERLiNK	Wireless connection (Bluetooth) to: FLIR meters with METERLiNK
Report generation	<ul style="list-style-type: none"> Instant Report (*.pdf file) in camera including IR and visual images Separate PC software with extensive report generation
Geographic Information System	
Compass	Camera direction automatically added to every still image
Video recording in camera	
Non-radiometric IR video recording	MPEG-4 to memory card
Visual video recording	MPEG-4 to memory card
Video streaming	
Radiometric IR video streaming	Full dynamic to PC using USB or to mobile devices using Wi-Fi.
Non-radiometric IR video streaming	<ul style="list-style-type: none"> MPEG-4 using Wi-Fi Uncompressed colorized video using USB
Visual video streaming	<ul style="list-style-type: none"> MPEG-4 using Wi-Fi Uncompressed colorized video using USB
Digital camera	
Built-in digital camera	3.1 Mpixels with LED light (photo as separate image)
Digital camera, focus	Fixed focus
Digital camera, FOV	Adapts to the IR lens
Built-in digital lens data	FOV 53° × 41°
Digital camera, aspect ratio	4:3
Laser pointer	
Laser	Activated by dedicated button
Laser alignment	Position is automatic displayed on the IR image
Laser classification	Class 2
Laser type	Semiconductor AlGaInP diode laser
Laser power	1 mW
Laser wavelength	635 nm (red)
Data communication interfaces	
Interfaces	USB-mini, USB-A, Bluetooth, Wi-Fi, composite video
METERLiNK/Bluetooth	Communication with headset and external sensors
Wi-Fi	Peer to peer (ad hoc) or infrastructure (network)
SD Card	One card slot for removable SD memory cards
USB	
USB	<ul style="list-style-type: none"> USB-A: Connect external USB device USB Mini-B: Data transfer to and from PC / uncompressed colorized video
USB, standard	USB Mini-B: 2.0

Composite video	
Video out	Composite
Video, standard	CVBS (ITU-R-BT.470 PAL/SMPTE 170M NTSC)
Video, connector type	4-pole 3.5 mm jack
Radio	
Wi-Fi	<ul style="list-style-type: none"> • Standard: 802.11 b/g • Frequency range: 2412–2462 MHz • Max. output power: 15 dBm
METERLiNK/Bluetooth	Frequency range: 2402–2480 MHz
Antenna	Internal
Power system	
Battery type	Rechargeable Li ion battery
Battery voltage	3.7 V
Battery capacity	4.4 Ah, at +20°C to +25°C (+68°F to +77°F)
Battery operating time	Approx. 4 hours at +25°C (+77°F) ambient temperature and typical use
Charging system	In camera (AC adapter or 12 V from a vehicle) or 2-bay charger
Charging time	4 h to 90% capacity, charging status indicated by LED's
Charging temperature	0°C to +45°C (+32°F to +113°F)
Power management	Automatic shutdown and sleep mode (user selectable)
AC operation	AC adapter, 90–260 VAC input, 12 V output to camera
Start-up time from sleep mode	Instant on
Environmental data	
Operating temperature range	–15°C to +50°C (+5°F to +122°F)
Storage temperature range	–40°C to +70°C (–40°F to +158°F)
Humidity (operating and storage)	IEC 60068-2-30/24 h 95% relative humidity +25°C to +40°C (+77°F to +104°F) / 2 cycles
EMC	<ul style="list-style-type: none"> • ETSI EN 301 489-1 (radio) • ETSI EN 301 489-17 • EN 61000-6-2 (Immunity) • EN 61000-6-3 (Emission) • FCC 47 CFR Part 15 B (Emission) • ICES-003
Radio spectrum	<ul style="list-style-type: none"> • ETSI EN 300 328 • FCC Part 15.247 • RSS-210
Magnetic fields	EN 61 000-4-8, Test level 5 for continuous field (severe industrial environment)
Encapsulation	IP 54 (IEC 60529)
Shock	25 g (IEC 60068-2-27)
Vibration	2 g (IEC 60068-2-6)
Safety	EN/UL/CSA/PSE 60950-1

Physical data	
Camera weight, incl. battery	0.855 kg (1.88 lb.)
Camera size (L × W × H)	106 × 201 × 125 mm (4.2 × 7.9 × 4.9 in.), with built-in lens pointing forward
Tripod mounting	UNC ¼"-20 (adapter needed)
Material	<ul style="list-style-type: none"> • Polycarbonate + acrylonitrile butadiene styrene (PC-ABS) • Thixomold magnesium • Thermoplastic elastomer (TPE)
Color	Graphite gray and black
Shipping information	
Packaging, type	Cardboard box
List of contents	<ul style="list-style-type: none"> • Infrared camera with lens • Battery (2 ea.) • Battery charger • Bluetooth headset • Camera lens cap • Calibration certificate • FLIR ResearchIR Standard 4 • Printed documentation • Hard transport case • Memory card • Neckstrap • Power supply, incl. multi-plugs • Sunshield • USB cable • Video cable
Packaging, weight	
Packaging, size	495 × 192 × 370 mm (19.49 × 7.56 × 14.57 in.)
EAN-13	
UPC-12	
Country of origin	Sweden

Supplies & accessories:

- 1196960; IR lens, f = 10 mm, 45° incl. case
- T197214; Close-up 2× (50 µm) incl. case
- T197000; High temp. option +1200°C (+2192°F)
- T199233; FLIR Atlas SDK for .NET
- T199234; FLIR Atlas SDK for MATLAB

24.15 FLIR T440 (incl. Wi-Fi and Ext. cal.) (60 Hz)

P/N: 62103-1304

Rev.: 35944

General description	
The FLIR T440 is a camera that offers good performance at an affordable price. Excellent ergonomics, a walk-up-and-use interface, and easy communication make the FLIR T440 a truly user-friendly camera for the beginner or advanced user.	
Benefits:	
<ul style="list-style-type: none"> • Excellent ergonomics: The FLIR T440 has a tiltable infrared unit and auto-orientation, which make it easy to capture images from any angle comfortably. The small size and low weight of the camera facilitate its use over a full working day. • Affordable performance: The FLIR T440 is equipped with the innovative Multi Spectral Dynamic Imaging (MSX) feature, which produces an image richer in detail than ever before. You can highlight objects of interest, on both the infrared and the visual images, by sketching or adding predefined stamps directly onto the camera's touch screen. • Extensive communication options: The Wi-Fi connectivity of the FLIR T440 allows you to connect to smart phones or tablets, for the wireless transfer of images or the remote control of the camera. The Bluetooth-based METERLiNK function transfers readings from external measurement instruments to the infrared image. • Support for UltraMax: When enabling UltraMax in the camera, the resolution of images can be substantially enhanced when importing the images into FLIR Tools. 	
Imaging and optical data	
IR resolution	320 × 240 pixels
MSX resolution	320 × 240 pixels
UltraMax	Yes
Thermal sensitivity/NETD	<40 mK @ +30°C (+86°F)
Field of view (FOV)	25° × 19°
Minimum focus distance	0.4 m (1.31 ft.)
Focal length	18 mm (0.7 in.)
Spatial resolution (IFOV)	1.36 mrad
F-number	1.3
Image frequency	60 Hz
Focus	Automatic (one shot) or manual
Digital zoom	2x, 4x and 8x
Detector data	
Detector type	Focal plane array (FPA), uncooled microbolometer
Spectral range	7.5–13 μm
Detector pitch	25 μm
Image presentation	
Display	Touch screen, 3.5 in. LCD, 320 × 240 pixels
Auto orientation	Automatic landscape or portrait
Image adjustment	Auto or manual
Image presentation modes	
Thermal MSX	Thermal image with enhanced detail presentation
Picture in Picture	Resizable and movable IR area on visual image

Measurement	
Object temperature range	<ul style="list-style-type: none"> • -20°C to +120°C (-4°F to +248°F) • 0°C to +650°C (+32°F to +1202°F) • +250°C to +1200°C (+482°F to +2192°F)
Accuracy	±2°C (±3.6°F) or 2%, whichever is greater, at 25°C (77°F) nominal.
Measurement analysis	
Spotmeter	5
Area	5 + 5 areas (boxes or circles) with max./min./average (in post-acquisition analysis)
Profile	1 line profile with max/min temp.
Automatic hot/cold detection	Auto hot or cold spotmeter markers within area and profile
Measurement presets	No measurements, Center spot, Hot spot, Cold spot, User preset 1, User preset 2
User presets (in live images)	The user can select and combine measurements from any number of available spots/boxes/circles/profiles/delta
Difference temperature	Delta temperature between measurement functions or reference temperature
Reference temperature	Manually set using difference temperature
Emissivity correction	Variable from 0.01 to 1.0 or selected from materials list
Measurement corrections	Emissivity, reflected temperature, relative humidity, atmospheric temperature, object distance, external IR window compensation
Colors (palettes)	Iron, Rainbow, Rainbow HC, White hot, Black hot, Arctic, Lava
Alarm	
Color Alarm (isotherm)	Above/below/interval
Measurement function alarm	Audible/visual alarms (above/below) on any selected measurement function
Screening	Difference temperature alarm, audible
Set-up	
Set-up commands	Define user presets, Save options, Programmable button, Reset options, Set up camera, Wi-Fi, Compass, Bluetooth, Language, Time & units, Camera information
Service functions	
Camera software update	Use PC software FLIR Tools
Storage of images	
Image storage	Standard JPEG, including digital photo and measurement data, on memory card
Image storage mode	<ul style="list-style-type: none"> • Simultaneous storage of thermal and digital photo in same JPEG file. • Optional to store digital photo as a separate JPEG file.
Time lapse	15 seconds to 24 hours

Image annotations (in still images)	
Voice	60 seconds (via Bluetooth) stored with the image
Text	Add table. Select between predefined templates or create your own in FLIR Tools
Image description	Add short note (stored in JPEG EXIF tag)
Sketch	Draw on thermal/digital photo or add predefined stamps
METERLiNK	Wireless connection (Bluetooth) to: FLIR meters with METERLiNK
Report generation	<ul style="list-style-type: none"> Instant Report (*.pdf file) in camera including IR and visual images Separate PC software with extensive report generation
Geographic Information System	
Compass	Camera direction automatically added to every still image
Video recording in camera	
Non-radiometric IR video recording	MPEG-4 to memory card
Visual video recording	MPEG-4 to memory card
Video streaming	
Radiometric IR video streaming	Full dynamic to PC using USB or to mobile devices using Wi-Fi.
Non-radiometric IR video streaming	<ul style="list-style-type: none"> MPEG-4 using Wi-Fi Uncompressed colorized video using USB
Visual video streaming	<ul style="list-style-type: none"> MPEG-4 using Wi-Fi Uncompressed colorized video using USB
Digital camera	
Built-in digital camera	3.1 Mpixels with LED light (photo as separate image)
Digital camera, focus	Fixed focus
Digital camera, FOV	Adapts to the IR lens
Built-in digital lens data	FOV 53° × 41°
Digital camera, aspect ratio	4:3
Laser pointer	
Laser	Activated by dedicated button
Laser alignment	Position is automatic displayed on the IR image
Laser classification	Class 2
Laser type	Semiconductor AlGaInP diode laser
Laser power	1 mW
Laser wavelength	635 nm (red)
Data communication interfaces	
Interfaces	USB-mini, USB-A, Bluetooth, Wi-Fi, composite video
METERLiNK/Bluetooth	Communication with headset and external sensors

Data communication interfaces	
Wi-Fi	Peer to peer (ad hoc) or infrastructure (network)
SD Card	One card slot for removable SD memory cards
USB	
USB	<ul style="list-style-type: none"> • USB-A: Connect external USB device • USB Mini-B: Data transfer to and from PC / uncompressed colorized video
USB, standard	USB Mini-B: 2.0
Composite video	
Video out	Composite
Video, standard	CVBS (ITU-R-BT.470 PAL/SMPTE 170M NTSC)
Video, connector type	4-pole 3.5 mm jack
Radio	
Wi-Fi	<ul style="list-style-type: none"> • Standard: 802.11 b/g • Frequency range: 2412–2462 MHz • Max. output power: 15 dBm
METERLiNK/Bluetooth	Frequency range: 2402–2480 MHz
Antenna	Internal
Power system	
Battery type	Rechargeable Li ion battery
Battery voltage	3.7 V
Battery capacity	4.4 Ah, at +20°C to +25°C (+68°F to +77°F)
Battery operating time	Approx. 4 hours at +25°C (+77°F) ambient temperature and typical use
Charging system	In camera (AC adapter or 12 V from a vehicle) or 2-bay charger
Charging time	4 h to 90% capacity, charging status indicated by LED's
Charging temperature	0°C to +45°C (+32°F to +113°F)
Power management	Automatic shutdown and sleep mode (user selectable)
AC operation	AC adapter, 90–260 VAC input, 12 V output to camera
Start-up time from sleep mode	Instant on
Environmental data	
Operating temperature range	–15°C to +50°C (+5°F to +122°F)
Storage temperature range	–40°C to +70°C (–40°F to +158°F)
Humidity (operating and storage)	IEC 60068-2-30/24 h 95% relative humidity +25°C to +40°C (+77°F to +104°F) / 2 cycles
EMC	<ul style="list-style-type: none"> • ETSI EN 301 489-1 (radio) • ETSI EN 301 489-17 • EN 61000-6-2 (Immunity) • EN 61000-6-3 (Emission) • FCC 47 CFR Part 15 B (Emission) • ICES-003
Radio spectrum	<ul style="list-style-type: none"> • ETSI EN 300 328 • FCC Part 15.247 • RSS-210

Environmental data	
Magnetic fields	EN 61 000-4-8, Test level 5 for continuous field (severe industrial environment)
Encapsulation	IP 54 (IEC 60529)
Shock	25 g (IEC 60068-2-27)
Vibration	2 g (IEC 60068-2-6)
Safety	EN/UL/CSA/PSE 60950-1
Physical data	
Camera weight, incl. battery	0.855 kg (1.88 lb.)
Camera size (L x W x H)	106 x 201 x 125 mm (4.2 x 7.9 x 4.9 in.), with built-in lens pointing forward
Tripod mounting	UNC ¼"-20 (adapter needed)
Material	<ul style="list-style-type: none"> • Polycarbonate + acrylonitrile butadiene styrene (PC-ABS) • Thixomold magnesium • Thermoplastic elastomer (TPE)
Color	Graphite gray and black
Shipping information	
Packaging, type	Cardboard box
List of contents	<ul style="list-style-type: none"> • Infrared camera with lens • Battery (2 ea.) • Battery charger • Bluetooth headset • Camera lens cap • Calibration certificate • Extended calibration certificate • Hard transport case • Memory card • Neckstrap • Power supply, incl. multi-plugs • Printed documentation • Sunshield • USB cable • Video cable
Packaging, weight	5.7 kg (12.6 lb.)
Packaging, size	495 x 192 x 370 mm (19.49 x 7.56 x 14.57 in.)
EAN-13	7332558012130
UPC-12	845188013233
Country of origin	Sweden

Supplies & accessories:

- 1196961; IR lens, f = 30 mm, 15° incl. case
- 1196960; IR lens, f = 10 mm, 45° incl. case
- T197215; Close-up 4x (100 µm) incl. case
- T197214; Close-up 2x (50 µm) incl. case
- T197408; IR lens, 76 mm (6°) with case and mounting support for T/B-200/400
- T197412; IR lens, 4 mm (90°) with case and mounting support for T/B2xx-4xx
- T197000; High temp. option +1200°C (+2192°F)
- T910814; Power supply, incl. multi plugs
- T197650; 2-bay battery charger, incl. power supply with multi plugs
- 1196398ACC; Battery
- T911230ACC; Memory card SDHC 4 GB
- 1910423; USB cable Std A <-> Mini-B
- T198509; Cigarette lighter adapter kit, 12 VDC, 1.2 m/3.9 ft.
- 1910582ACC; Video cable

- T198370ACC; Hard transport case for FLIR T/B2xx-4xx
- T198495; Pouch for FLIR T6xx and T4xx series
- 1124545; Pouch
- T198493; Sun shield
- T198499; Neck strap
- T197771ACC; Bluetooth Headset
- T911093; Tool belt
- 19250-100; IR Window 2 in
- 19251-100; IR Window 3 in.
- 19252-100; IR Window 4 in.
- 19250-200; SS IR Window 2 in.
- 19251-200; SS IR Window 3 in.
- 19252-200; SS IR Window 4 in.
- T198586; FLIR Reporter Professional (license only)
- T198584; FLIR Tools
- T198583; FLIR Tools+ (download card incl. license key)
- DSW-10000; FLIR IR Camera Player
- APP-10002; FLIR Tools Mobile (Android Application)
- APP-10004; FLIR Tools (MacOS Application)
- T198697; FLIR ResearchIR Max + HSDR 4 (hardware sec. dev.)
- T199014; FLIR ResearchIR Max + HSDR 4 (printed license key)
- T199044; FLIR ResearchIR Max + HSDR 4 Upgrade (printed license key)
- T198696; FLIR ResearchIR Max 4 (hardware sec. dev.)
- T199013; FLIR ResearchIR Max 4 (printed license key)
- T199043; FLIR ResearchIR Max 4 Upgrade (printed license key)
- T198731; FLIR ResearchIR Standard 4 (hardware sec. dev.)
- T199012; FLIR ResearchIR Standard 4 (printed license key)
- T199042; FLIR ResearchIR Standard 4 Upgrade (printed license key)
- T199233; FLIR Atlas SDK for .NET
- T199234; FLIR Atlas SDK for MATLAB

24.16 FLIR T440 (incl. Wi-Fi and 15° lens)

P/N: 62103-1302

Rev.: 35207

General description	
The FLIR T440 is a camera that offers good performance at an affordable price. Excellent ergonomics, a walk-up-and-use interface, and easy communication make the FLIR T440 a truly user-friendly camera for the beginner or advanced user.	
Benefits:	
<ul style="list-style-type: none"> • Excellent ergonomics: The FLIR T440 has a tiltable infrared unit and auto-orientation, which make it easy to capture images from any angle comfortably. The small size and low weight of the camera facilitate its use over a full working day. • Affordable performance: The FLIR T440 is equipped with the innovative Multi Spectral Dynamic Imaging (MSX) feature, which produces an image richer in detail than ever before. You can highlight objects of interest, on both the infrared and the visual images, by sketching or adding predefined stamps directly onto the camera's touch screen. • Extensive communication options: The Wi-Fi connectivity of the FLIR T440 allows you to connect to smart phones or tablets, for the wireless transfer of images or the remote control of the camera. The Bluetooth-based METERLiNK function transfers readings from external measurement instruments to the infrared image. • Support for UltraMax: When enabling UltraMax in the camera, the resolution of images can be substantially enhanced when importing the images into FLIR Tools. 	
Imaging and optical data	
IR resolution	320 × 240 pixels
MSX resolution	320 × 240 pixels
UltraMax	Yes
Thermal sensitivity/NETD	<40 mK @ +30°C (+86°F)
Field of view (FOV)	25° × 19°
Minimum focus distance	0.4 m (1.31 ft.)
Focal length	18 mm (0.7 in.)
Spatial resolution (IFOV)	1.36 mrad
F-number	1.3
Image frequency	60 Hz
Focus	Automatic (one shot) or manual
Digital zoom	2x, 4x and 8x
Detector data	
Detector type	Focal plane array (FPA), uncooled microbolometer
Spectral range	7.5–13 μm
Detector pitch	25 μm
Image presentation	
Display	Touch screen, 3.5 in. LCD, 320 × 240 pixels
Auto orientation	Automatic landscape or portrait
Image adjustment	Auto or manual
Image presentation modes	
Thermal MSX	Thermal image with enhanced detail presentation
Picture in Picture	Resizable and movable IR area on visual image

Measurement	
Object temperature range	<ul style="list-style-type: none"> • -20°C to +120°C (-4°F to +248°F) • 0°C to +650°C (+32°F to +1202°F) • +250°C to +1200°C (+482°F to +2192°F)
Accuracy	±2°C (±3.6°F) or 2%, whichever is greater, at 25°C (77°F) nominal.
Measurement analysis	
Spotmeter	5
Area	5 + 5 areas (boxes or circles) with max./min./average (in post-acquisition analysis)
Profile	1 line profile with max/min temp.
Automatic hot/cold detection	Auto hot or cold spotmeter markers within area and profile
Measurement presets	No measurements, Center spot, Hot spot, Cold spot, User preset 1, User preset 2
User presets (in live images)	The user can select and combine measurements from any number of available spots/boxes/circles/profiles/delta
Difference temperature	Delta temperature between measurement functions or reference temperature
Reference temperature	Manually set using difference temperature
Emissivity correction	Variable from 0.01 to 1.0 or selected from materials list
Measurement corrections	Emissivity, reflected temperature, relative humidity, atmospheric temperature, object distance, external IR window compensation
Colors (palettes)	Iron, Rainbow, Rainbow HC, White hot, Black hot, Arctic, Lava
Alarm	
Color Alarm (isotherm)	Above/below/interval
Measurement function alarm	Audible/visual alarms (above/below) on any selected measurement function
Screening	Difference temperature alarm, audible
Set-up	
Set-up commands	Define user presets, Save options, Programmable button, Reset options, Set up camera, Wi-Fi, Compass, Bluetooth, Language, Time & units, Camera information
Service functions	
Camera software update	Use PC software FLIR Tools
Storage of images	
Image storage	Standard JPEG, including digital photo and measurement data, on memory card
Image storage mode	<ul style="list-style-type: none"> • Simultaneous storage of thermal and digital photo in same JPEG file. • Optional to store digital photo as a separate JPEG file.
Time lapse	15 seconds to 24 hours

Image annotations (in still images)	
Voice	60 seconds (via Bluetooth) stored with the image
Text	Add table. Select between predefined templates or create your own in FLIR Tools
Image description	Add short note (stored in JPEG EXIF tag)
Sketch	Draw on thermal/digital photo or add predefined stamps
METERLiNK	Wireless connection (Bluetooth) to: FLIR meters with METERLiNK
Report generation	<ul style="list-style-type: none"> Instant Report (*.pdf file) in camera including IR and visual images Separate PC software with extensive report generation
Geographic Information System	
Compass	Camera direction automatically added to every still image
Video recording in camera	
Non-radiometric IR video recording	MPEG-4 to memory card
Visual video recording	MPEG-4 to memory card
Video streaming	
Radiometric IR video streaming	Full dynamic to PC using USB or to mobile devices using Wi-Fi.
Non-radiometric IR video streaming	<ul style="list-style-type: none"> MPEG-4 using Wi-Fi Uncompressed colorized video using USB
Visual video streaming	<ul style="list-style-type: none"> MPEG-4 using Wi-Fi Uncompressed colorized video using USB
Digital camera	
Built-in digital camera	3.1 Mpixels with LED light (photo as separate image)
Digital camera, focus	Fixed focus
Digital camera, FOV	Adapts to the IR lens
Built-in digital lens data	FOV 53° × 41°
Digital camera, aspect ratio	4:3
Laser pointer	
Laser	Activated by dedicated button
Laser alignment	Position is automatic displayed on the IR image
Laser classification	Class 2
Laser type	Semiconductor AlGaInP diode laser
Laser power	1 mW
Laser wavelength	635 nm (red)
Data communication interfaces	
Interfaces	USB-mini, USB-A, Bluetooth, Wi-Fi, composite video
METERLiNK/Bluetooth	Communication with headset and external sensors

Data communication interfaces	
Wi-Fi	Peer to peer (ad hoc) or infrastructure (network)
SD Card	One card slot for removable SD memory cards
USB	
USB	<ul style="list-style-type: none"> • USB-A: Connect external USB device • USB Mini-B: Data transfer to and from PC / uncompressed colorized video
USB, standard	USB Mini-B: 2.0
Composite video	
Video out	Composite
Video, standard	CVBS (ITU-R-BT.470 PAL/SMPTE 170M NTSC)
Video, connector type	4-pole 3.5 mm jack
Radio	
Wi-Fi	<ul style="list-style-type: none"> • Standard: 802.11 b/g • Frequency range: 2412–2462 MHz • Max. output power: 15 dBm
METERLiNK/Bluetooth	Frequency range: 2402–2480 MHz
Antenna	Internal
Power system	
Battery type	Rechargeable Li ion battery
Battery voltage	3.7 V
Battery capacity	4.4 Ah, at +20°C to +25°C (+68°F to +77°F)
Battery operating time	Approx. 4 hours at +25°C (+77°F) ambient temperature and typical use
Charging system	In camera (AC adapter or 12 V from a vehicle) or 2-bay charger
Charging time	4 h to 90% capacity, charging status indicated by LED's
Charging temperature	0°C to +45°C (+32°F to +113°F)
Power management	Automatic shutdown and sleep mode (user selectable)
AC operation	AC adapter, 90–260 VAC input, 12 V output to camera
Start-up time from sleep mode	Instant on
Environmental data	
Operating temperature range	–15°C to +50°C (+5°F to +122°F)
Storage temperature range	–40°C to +70°C (–40°F to +158°F)
Humidity (operating and storage)	IEC 60068-2-30/24 h 95% relative humidity +25°C to +40°C (+77°F to +104°F) / 2 cycles
EMC	<ul style="list-style-type: none"> • ETSI EN 301 489-1 (radio) • ETSI EN 301 489-17 • EN 61000-6-2 (Immunity) • EN 61000-6-3 (Emission) • FCC 47 CFR Part 15 B (Emission) • ICES-003
Radio spectrum	<ul style="list-style-type: none"> • ETSI EN 300 328 • FCC Part 15.247 • RSS-210

Environmental data	
Magnetic fields	EN 61 000-4-8, Test level 5 for continuous field (severe industrial environment)
Encapsulation	IP 54 (IEC 60529)
Shock	25 g (IEC 60068-2-27)
Vibration	2 g (IEC 60068-2-6)
Safety	EN/UL/CSA/PSE 60950-1
Physical data	
Camera weight, incl. battery	0.855 kg (1.88 lb.)
Camera size (L x W x H)	106 x 201 x 125 mm (4.2 x 7.9 x 4.9 in.), with built-in lens pointing forward
Tripod mounting	UNC ¼"-20 (adapter needed)
Material	<ul style="list-style-type: none"> Polycarbonate + acrylonitrile butadiene styrene (PC-ABS) Thixomold magnesium Thermoplastic elastomer (TPE)
Color	Graphite gray and black
Shipping information	
Packaging, type	Cardboard box
List of contents	<ul style="list-style-type: none"> Infrared camera with lens Battery (2 ea.) Battery charger Bluetooth headset Camera lens cap Calibration certificate Printed documentation Hard transport case Memory card Neckstrap Power supply, incl. multi-plugs Sunshield USB cable Video cable IR lens, f = 30 mm, 15°
Packaging, weight	5.7 kg (12.6 lb.)
Packaging, size	495 x 192 x 370 mm (19.49 x 7.56 x 14.57 in.)
EAN-13	7332558010846
UPC-12	845188011598
Country of origin	Sweden

Supplies & accessories:

- 1196961; IR lens, f = 30 mm, 15° incl. case
- 1196960; IR lens, f = 10 mm, 45° incl. case
- T197215; Close-up 4x (100 µm) incl. case
- T197214; Close-up 2x (50 µm) incl. case
- T197408; IR lens, 76 mm (6°) with case and mounting support for T/B-200/400
- T197412; IR lens, 4 mm (90°) with case and mounting support for T/B2xx-4xx
- T197000; High temp. option +1200°C (+2192°F)
- T910814; Power supply, incl. multi plugs
- T197650; 2-bay battery charger, incl. power supply with multi plugs
- 1196398ACC; Battery
- T911230ACC; Memory card SDHC 4 GB
- 1910423; USB cable Std A <-> Mini-B
- T198509; Cigarette lighter adapter kit, 12 VDC, 1.2 m/3.9 ft.
- 1910582ACC; Video cable

- T198370ACC; Hard transport case for FLIR T/B2xx-4xx
- T198495; Pouch for FLIR T6xx and T4xx series
- 1124545; Pouch
- T198493; Sun shield
- T198499; Neck strap
- T197771ACC; Bluetooth Headset
- T911093; Tool belt
- 19250-100; IR Window 2 in
- 19251-100; IR Window 3 in.
- 19252-100; IR Window 4 in.
- 19250-200; SS IR Window 2 in.
- 19251-200; SS IR Window 3 in.
- 19252-200; SS IR Window 4 in.
- T198586; FLIR Reporter Professional (license only)
- T198584; FLIR Tools
- T198583; FLIR Tools+ (download card incl. license key)
- DSW-10000; FLIR IR Camera Player
- APP-10002; FLIR Tools Mobile (Android Application)
- APP-10004; FLIR Tools (MacOS Application)
- T198697; FLIR ResearchIR Max + HSDR 4 (hardware sec. dev.)
- T199014; FLIR ResearchIR Max + HSDR 4 (printed license key)
- T199044; FLIR ResearchIR Max + HSDR 4 Upgrade (printed license key)
- T198696; FLIR ResearchIR Max 4 (hardware sec. dev.)
- T199013; FLIR ResearchIR Max 4 (printed license key)
- T199043; FLIR ResearchIR Max 4 Upgrade (printed license key)
- T198731; FLIR ResearchIR Standard 4 (hardware sec. dev.)
- T199012; FLIR ResearchIR Standard 4 (printed license key)
- T199042; FLIR ResearchIR Standard 4 Upgrade (printed license key)
- T199233; FLIR Atlas SDK for .NET
- T199234; FLIR Atlas SDK for MATLAB

24.17 FLIR T440 (incl. Wi-Fi and 45° lens)

P/N: 62103-1303

Rev.: 35207

General description	
The FLIR T440 is a camera that offers good performance at an affordable price. Excellent ergonomics, a walk-up-and-use interface, and easy communication make the FLIR T440 a truly user-friendly camera for the beginner or advanced user.	
Benefits:	
<ul style="list-style-type: none"> • Excellent ergonomics: The FLIR T440 has a tiltable infrared unit and auto-orientation, which make it easy to capture images from any angle comfortably. The small size and low weight of the camera facilitate its use over a full working day. • Affordable performance: The FLIR T440 is equipped with the innovative Multi Spectral Dynamic Imaging (MSX) feature, which produces an image richer in detail than ever before. You can highlight objects of interest, on both the infrared and the visual images, by sketching or adding predefined stamps directly onto the camera's touch screen. • Extensive communication options: The Wi-Fi connectivity of the FLIR T440 allows you to connect to smart phones or tablets, for the wireless transfer of images or the remote control of the camera. The Bluetooth-based METERLiNK function transfers readings from external measurement instruments to the infrared image. • Support for UltraMax: When enabling UltraMax in the camera, the resolution of images can be substantially enhanced when importing the images into FLIR Tools. 	
Imaging and optical data	
IR resolution	320 × 240 pixels
MSX resolution	320 × 240 pixels
UltraMax	Yes
Thermal sensitivity/NETD	<40 mK @ +30°C (+86°F)
Field of view (FOV)	25° × 19°
Minimum focus distance	0.4 m (1.31 ft.)
Focal length	18 mm (0.7 in.)
Spatial resolution (IFOV)	1.36 mrad
F-number	1.3
Image frequency	60 Hz
Focus	Automatic (one shot) or manual
Digital zoom	2x, 4x and 8x
Detector data	
Detector type	Focal plane array (FPA), uncooled microbolometer
Spectral range	7.5–13 μm
Detector pitch	25 μm
Image presentation	
Display	Touch screen, 3.5 in. LCD, 320 × 240 pixels
Auto orientation	Automatic landscape or portrait
Image adjustment	Auto or manual
Image presentation modes	
Thermal MSX	Thermal image with enhanced detail presentation
Picture in Picture	Resizable and movable IR area on visual image

Measurement	
Object temperature range	<ul style="list-style-type: none"> • -20°C to +120°C (-4°F to +248°F) • 0°C to +650°C (+32°F to +1202°F) • +250°C to +1200°C (+482°F to +2192°F)
Accuracy	±2°C (±3.6°F) or 2%, whichever is greater, at 25°C (77°F) nominal.
Measurement analysis	
Spotmeter	5
Area	5 + 5 areas (boxes or circles) with max./min./average (in post-acquisition analysis)
Profile	1 line profile with max/min temp.
Automatic hot/cold detection	Auto hot or cold spotmeter markers within area and profile
Measurement presets	No measurements, Center spot, Hot spot, Cold spot, User preset 1, User preset 2
User presets (in live images)	The user can select and combine measurements from any number of available spots/boxes/circles/profiles/delta
Difference temperature	Delta temperature between measurement functions or reference temperature
Reference temperature	Manually set using difference temperature
Emissivity correction	Variable from 0.01 to 1.0 or selected from materials list
Measurement corrections	Emissivity, reflected temperature, relative humidity, atmospheric temperature, object distance, external IR window compensation
Colors (palettes)	Iron, Rainbow, Rainbow HC, White hot, Black hot, Arctic, Lava
Alarm	
Color Alarm (isotherm)	Above/below/interval
Measurement function alarm	Audible/visual alarms (above/below) on any selected measurement function
Screening	Difference temperature alarm, audible
Set-up	
Set-up commands	Define user presets, Save options, Programmable button, Reset options, Set up camera, Wi-Fi, Compass, Bluetooth, Language, Time & units, Camera information
Service functions	
Camera software update	Use PC software FLIR Tools
Storage of images	
Image storage	Standard JPEG, including digital photo and measurement data, on memory card
Image storage mode	<ul style="list-style-type: none"> • Simultaneous storage of thermal and digital photo in same JPEG file. • Optional to store digital photo as a separate JPEG file.
Time lapse	15 seconds to 24 hours

Image annotations (in still images)	
Voice	60 seconds (via Bluetooth) stored with the image
Text	Add table. Select between predefined templates or create your own in FLIR Tools
Image description	Add short note (stored in JPEG EXIF tag)
Sketch	Draw on thermal/digital photo or add predefined stamps
METERLiNK	Wireless connection (Bluetooth) to: FLIR meters with METERLiNK
Report generation	<ul style="list-style-type: none"> Instant Report (*.pdf file) in camera including IR and visual images Separate PC software with extensive report generation
Geographic Information System	
Compass	Camera direction automatically added to every still image
Video recording in camera	
Non-radiometric IR video recording	MPEG-4 to memory card
Visual video recording	MPEG-4 to memory card
Video streaming	
Radiometric IR video streaming	Full dynamic to PC using USB or to mobile devices using Wi-Fi.
Non-radiometric IR video streaming	<ul style="list-style-type: none"> MPEG-4 using Wi-Fi Uncompressed colorized video using USB
Visual video streaming	<ul style="list-style-type: none"> MPEG-4 using Wi-Fi Uncompressed colorized video using USB
Digital camera	
Built-in digital camera	3.1 Mpixels with LED light (photo as separate image)
Digital camera, focus	Fixed focus
Digital camera, FOV	Adapts to the IR lens
Built-in digital lens data	FOV 53° × 41°
Digital camera, aspect ratio	4:3
Laser pointer	
Laser	Activated by dedicated button
Laser alignment	Position is automatic displayed on the IR image
Laser classification	Class 2
Laser type	Semiconductor AlGaInP diode laser
Laser power	1 mW
Laser wavelength	635 nm (red)
Data communication interfaces	
Interfaces	USB-mini, USB-A, Bluetooth, Wi-Fi, composite video
METERLiNK/Bluetooth	Communication with headset and external sensors

Data communication interfaces	
Wi-Fi	Peer to peer (ad hoc) or infrastructure (network)
SD Card	One card slot for removable SD memory cards
USB	
USB	<ul style="list-style-type: none"> • USB-A: Connect external USB device • USB Mini-B: Data transfer to and from PC / un-compressed colorized video
USB, standard	USB Mini-B: 2.0
Composite video	
Video out	Composite
Video, standard	CVBS (ITU-R-BT.470 PAL/SMPTE 170M NTSC)
Video, connector type	4-pole 3.5 mm jack
Radio	
Wi-Fi	<ul style="list-style-type: none"> • Standard: 802.11 b/g • Frequency range: 2412–2462 MHz • Max. output power: 15 dBm
METERLiNK/Bluetooth	Frequency range: 2402–2480 MHz
Antenna	Internal
Power system	
Battery type	Rechargeable Li ion battery
Battery voltage	3.7 V
Battery capacity	4.4 Ah, at +20°C to +25°C (+68°F to +77°F)
Battery operating time	Approx. 4 hours at +25°C (+77°F) ambient temperature and typical use
Charging system	In camera (AC adapter or 12 V from a vehicle) or 2-bay charger
Charging time	4 h to 90% capacity, charging status indicated by LED's
Charging temperature	0°C to +45°C (+32°F to +113°F)
Power management	Automatic shutdown and sleep mode (user selectable)
AC operation	AC adapter, 90–260 VAC input, 12 V output to camera
Start-up time from sleep mode	Instant on
Environmental data	
Operating temperature range	–15°C to +50°C (+5°F to +122°F)
Storage temperature range	–40°C to +70°C (–40°F to +158°F)
Humidity (operating and storage)	IEC 60068-2-30/24 h 95% relative humidity +25°C to +40°C (+77°F to +104°F) / 2 cycles
EMC	<ul style="list-style-type: none"> • ETSI EN 301 489-1 (radio) • ETSI EN 301 489-17 • EN 61000-6-2 (Immunity) • EN 61000-6-3 (Emission) • FCC 47 CFR Part 15 B (Emission) • ICES-003
Radio spectrum	<ul style="list-style-type: none"> • ETSI EN 300 328 • FCC Part 15.247 • RSS-210

Environmental data	
Magnetic fields	EN 61 000-4-8, Test level 5 for continuous field (severe industrial environment)
Encapsulation	IP 54 (IEC 60529)
Shock	25 g (IEC 60068-2-27)
Vibration	2 g (IEC 60068-2-6)
Safety	EN/UL/CSA/PSE 60950-1
Physical data	
Camera weight, incl. battery	0.855 kg (1.88 lb.)
Camera size (L x W x H)	106 x 201 x 125 mm (4.2 x 7.9 x 4.9 in.), with built-in lens pointing forward
Tripod mounting	UNC ¼"-20 (adapter needed)
Material	<ul style="list-style-type: none"> • Polycarbonate + acrylonitrile butadiene styrene (PC-ABS) • Thixomold magnesium • Thermoplastic elastomer (TPE)
Color	Graphite gray and black
Shipping information	
Packaging, type	Cardboard box
List of contents	<ul style="list-style-type: none"> • Infrared camera with lens • Battery (2 ea.) • Battery charger • Bluetooth headset • Camera lens cap • Calibration certificate • Printed documentation • Hard transport case • Memory card • Neckstrap • Power supply, incl. multi-plugs • Sunshield • USB cable • Video cable • IR lens, f = 10 mm, 45°
Packaging, weight	5.7 kg (12.6 lb.)
Packaging, size	495 x 192 x 370 mm (19.49 x 7.56 x 14.57 in.)
EAN-13	7332558010853
UPC-12	845188011604
Country of origin	Sweden

Supplies & accessories:

- 1196961; IR lens, f = 30 mm, 15° incl. case
- 1196960; IR lens, f = 10 mm, 45° incl. case
- T197215; Close-up 4x (100 µm) incl. case
- T197214; Close-up 2x (50 µm) incl. case
- T197408; IR lens, 76 mm (6°) with case and mounting support for T/B-200/400
- T197412; IR lens, 4 mm (90°) with case and mounting support for T/B2xx-4xx
- T197000; High temp. option +1200°C (+2192°F)
- T910814; Power supply, incl. multi plugs
- T197650; 2-bay battery charger, incl. power supply with multi plugs
- 1196398ACC; Battery
- T911230ACC; Memory card SDHC 4 GB
- 1910423; USB cable Std A <-> Mini-B
- T198509; Cigarette lighter adapter kit, 12 VDC, 1.2 m/3.9 ft.
- 1910582ACC; Video cable

-
- T198370ACC; Hard transport case for FLIR T/B2xx-4xx
 - T198495; Pouch for FLIR T6xx and T4xx series
 - 1124545; Pouch
 - T198493; Sun shield
 - T198499; Neck strap
 - T197771ACC; Bluetooth Headset
 - T911093; Tool belt
 - 19250-100; IR Window 2 in
 - 19251-100; IR Window 3 in.
 - 19252-100; IR Window 4 in.
 - 19250-200; SS IR Window 2 in.
 - 19251-200; SS IR Window 3 in.
 - 19252-200; SS IR Window 4 in.
 - T198586; FLIR Reporter Professional (license only)
 - T198584; FLIR Tools
 - T198583; FLIR Tools+ (download card incl. license key)
 - DSW-10000; FLIR IR Camera Player
 - APP-10002; FLIR Tools Mobile (Android Application)
 - APP-10004; FLIR Tools (MacOS Application)
 - T198697; FLIR ResearchIR Max + HSDR 4 (hardware sec. dev.)
 - T199014; FLIR ResearchIR Max + HSDR 4 (printed license key)
 - T199044; FLIR ResearchIR Max + HSDR 4 Upgrade (printed license key)
 - T198696; FLIR ResearchIR Max 4 (hardware sec. dev.)
 - T199013; FLIR ResearchIR Max 4 (printed license key)
 - T199043; FLIR ResearchIR Max 4 Upgrade (printed license key)
 - T198731; FLIR ResearchIR Standard 4 (hardware sec. dev.)
 - T199012; FLIR ResearchIR Standard 4 (printed license key)
 - T199042; FLIR ResearchIR Standard 4 Upgrade (printed license key)
 - T199233; FLIR Atlas SDK for .NET
 - T199234; FLIR Atlas SDK for MATLAB

24.18 FLIR T440 (incl. Wi-Fi)

P/N: 62103-1301

Rev.: 35207

General description	
The FLIR T440 is a camera that offers good performance at an affordable price. Excellent ergonomics, a walk-up-and-use interface, and easy communication make the FLIR T440 a truly user-friendly camera for the beginner or advanced user.	
Benefits:	
<ul style="list-style-type: none"> • Excellent ergonomics: The FLIR T440 has a tiltable infrared unit and auto-orientation, which make it easy to capture images from any angle comfortably. The small size and low weight of the camera facilitate its use over a full working day. • Affordable performance: The FLIR T440 is equipped with the innovative Multi Spectral Dynamic Imaging (MSX) feature, which produces an image richer in detail than ever before. You can highlight objects of interest, on both the infrared and the visual images, by sketching or adding predefined stamps directly onto the camera's touch screen. • Extensive communication options: The Wi-Fi connectivity of the FLIR T440 allows you to connect to smart phones or tablets, for the wireless transfer of images or the remote control of the camera. The Bluetooth-based METERLiNK function transfers readings from external measurement instruments to the infrared image. • Support for UltraMax: When enabling UltraMax in the camera, the resolution of images can be substantially enhanced when importing the images into FLIR Tools. 	
Imaging and optical data	
IR resolution	320 × 240 pixels
MSX resolution	320 × 240 pixels
UltraMax	Yes
Thermal sensitivity/NETD	<40 mK @ +30°C (+86°F)
Field of view (FOV)	25° × 19°
Minimum focus distance	0.4 m (1.31 ft.)
Focal length	18 mm (0.7 in.)
Spatial resolution (IFOV)	1.36 mrad
F-number	1.3
Image frequency	60 Hz
Focus	Automatic (one shot) or manual
Digital zoom	2x, 4x and 8x
Detector data	
Detector type	Focal plane array (FPA), uncooled microbolometer
Spectral range	7.5–13 μm
Detector pitch	25 μm
Image presentation	
Display	Touch screen, 3.5 in. LCD, 320 × 240 pixels
Auto orientation	Automatic landscape or portrait
Image adjustment	Auto or manual
Image presentation modes	
Thermal MSX	Thermal image with enhanced detail presentation
Picture in Picture	Resizable and movable IR area on visual image

Measurement	
Object temperature range	<ul style="list-style-type: none"> • -20°C to +120°C (-4°F to +248°F) • 0°C to +650°C (+32°F to +1202°F) • +250°C to +1200°C (+482°F to +2192°F)
Accuracy	±2°C (±3.6°F) or 2%, whichever is greater, at 25°C (77°F) nominal.
Measurement analysis	
Spotmeter	5
Area	5 + 5 areas (boxes or circles) with max./min./average (in post-acquisition analysis)
Profile	1 line profile with max/min temp.
Automatic hot/cold detection	Auto hot or cold spotmeter markers within area and profile
Measurement presets	No measurements, Center spot, Hot spot, Cold spot, User preset 1, User preset 2
User presets (in live images)	The user can select and combine measurements from any number of available spots/boxes/circles/profiles/delta
Difference temperature	Delta temperature between measurement functions or reference temperature
Reference temperature	Manually set using difference temperature
Emissivity correction	Variable from 0.01 to 1.0 or selected from materials list
Measurement corrections	Emissivity, reflected temperature, relative humidity, atmospheric temperature, object distance, external IR window compensation
Colors (palettes)	Iron, Rainbow, Rainbow HC, White hot, Black hot, Arctic, Lava
Alarm	
Color Alarm (isotherm)	Above/below/interval
Measurement function alarm	Audible/visual alarms (above/below) on any selected measurement function
Screening	Difference temperature alarm, audible
Set-up	
Set-up commands	Define user presets, Save options, Programmable button, Reset options, Set up camera, Wi-Fi, Compass, Bluetooth, Language, Time & units, Camera information
Service functions	
Camera software update	Use PC software FLIR Tools
Storage of images	
Image storage	Standard JPEG, including digital photo and measurement data, on memory card
Image storage mode	<ul style="list-style-type: none"> • Simultaneous storage of thermal and digital photo in same JPEG file. • Optional to store digital photo as a separate JPEG file.
Time lapse	15 seconds to 24 hours

Image annotations (in still images)	
Voice	60 seconds (via Bluetooth) stored with the image
Text	Add table. Select between predefined templates or create your own in FLIR Tools
Image description	Add short note (stored in JPEG EXIF tag)
Sketch	Draw on thermal/digital photo or add predefined stamps
METERLiNK	Wireless connection (Bluetooth) to: FLIR meters with METERLiNK
Report generation	<ul style="list-style-type: none"> Instant Report (*.pdf file) in camera including IR and visual images Separate PC software with extensive report generation
Geographic Information System	
Compass	Camera direction automatically added to every still image
Video recording in camera	
Non-radiometric IR video recording	MPEG-4 to memory card
Visual video recording	MPEG-4 to memory card
Video streaming	
Radiometric IR video streaming	Full dynamic to PC using USB or to mobile devices using Wi-Fi.
Non-radiometric IR video streaming	<ul style="list-style-type: none"> MPEG-4 using Wi-Fi Uncompressed colorized video using USB
Visual video streaming	<ul style="list-style-type: none"> MPEG-4 using Wi-Fi Uncompressed colorized video using USB
Digital camera	
Built-in digital camera	3.1 Mpixels with LED light (photo as separate image)
Digital camera, focus	Fixed focus
Digital camera, FOV	Adapts to the IR lens
Built-in digital lens data	FOV 53° × 41°
Digital camera, aspect ratio	4:3
Laser pointer	
Laser	Activated by dedicated button
Laser alignment	Position is automatic displayed on the IR image
Laser classification	Class 2
Laser type	Semiconductor AlGaInP diode laser
Laser power	1 mW
Laser wavelength	635 nm (red)
Data communication interfaces	
Interfaces	USB-mini, USB-A, Bluetooth, Wi-Fi, composite video
METERLiNK/Bluetooth	Communication with headset and external sensors

Data communication interfaces	
Wi-Fi	Peer to peer (ad hoc) or infrastructure (network)
SD Card	One card slot for removable SD memory cards
USB	
USB	<ul style="list-style-type: none"> • USB-A: Connect external USB device • USB Mini-B: Data transfer to and from PC / uncompressed colorized video
USB, standard	USB Mini-B: 2.0
Composite video	
Video out	Composite
Video, standard	CVBS (ITU-R-BT.470 PAL/SMPTE 170M NTSC)
Video, connector type	4-pole 3.5 mm jack
Radio	
Wi-Fi	<ul style="list-style-type: none"> • Standard: 802.11 b/g • Frequency range: 2412–2462 MHz • Max. output power: 15 dBm
METERLiNK/Bluetooth	Frequency range: 2402–2480 MHz
Antenna	Internal
Power system	
Battery type	Rechargeable Li ion battery
Battery voltage	3.7 V
Battery capacity	4.4 Ah, at +20°C to +25°C (+68°F to +77°F)
Battery operating time	Approx. 4 hours at +25°C (+77°F) ambient temperature and typical use
Charging system	In camera (AC adapter or 12 V from a vehicle) or 2-bay charger
Charging time	4 h to 90% capacity, charging status indicated by LED's
Charging temperature	0°C to +45°C (+32°F to +113°F)
Power management	Automatic shutdown and sleep mode (user selectable)
AC operation	AC adapter, 90–260 VAC input, 12 V output to camera
Start-up time from sleep mode	Instant on
Environmental data	
Operating temperature range	–15°C to +50°C (+5°F to +122°F)
Storage temperature range	–40°C to +70°C (–40°F to +158°F)
Humidity (operating and storage)	IEC 60068-2-30/24 h 95% relative humidity +25°C to +40°C (+77°F to +104°F) / 2 cycles
EMC	<ul style="list-style-type: none"> • ETSI EN 301 489-1 (radio) • ETSI EN 301 489-17 • EN 61000-6-2 (Immunity) • EN 61000-6-3 (Emission) • FCC 47 CFR Part 15 B (Emission) • ICES-003
Radio spectrum	<ul style="list-style-type: none"> • ETSI EN 300 328 • FCC Part 15.247 • RSS-210

Environmental data	
Magnetic fields	EN 61 000-4-8, Test level 5 for continuous field (severe industrial environment)
Encapsulation	IP 54 (IEC 60529)
Shock	25 g (IEC 60068-2-27)
Vibration	2 g (IEC 60068-2-6)
Safety	EN/UL/CSA/PSE 60950-1
Physical data	
Camera weight, incl. battery	0.855 kg (1.88 lb.)
Camera size (L x W x H)	106 x 201 x 125 mm (4.2 x 7.9 x 4.9 in.), with built-in lens pointing forward
Tripod mounting	UNC ¼"-20 (adapter needed)
Material	<ul style="list-style-type: none"> Polycarbonate + acrylonitrile butadiene styrene (PC-ABS) Thixomold magnesium Thermoplastic elastomer (TPE)
Color	Graphite gray and black
Shipping information	
Packaging, type	Cardboard box
List of contents	<ul style="list-style-type: none"> Infrared camera with lens Battery (2 ea.) Battery charger Bluetooth headset Camera lens cap Calibration certificate Printed documentation Hard transport case Memory card Neckstrap Power supply, incl. multi-plugs Sunshield USB cable Video cable
Packaging, weight	5.7 kg (12.6 lb.)
Packaging, size	495 x 192 x 370 mm (19.49 x 7.56 x 14.57 in.)
EAN-13	7332558006498
UPC-12	845188006846
Country of origin	Sweden

Supplies & accessories:

- 1196961; IR lens, f = 30 mm, 15° incl. case
- 1196960; IR lens, f = 10 mm, 45° incl. case
- T197215; Close-up 4x (100 µm) incl. case
- T197214; Close-up 2x (50 µm) incl. case
- T197408; IR lens, 76 mm (6°) with case and mounting support for T/B-200/400
- T197412; IR lens, 4 mm (90°) with case and mounting support for T/B2xx-4xx
- T197000; High temp. option +1200°C (+2192°F)
- T910814; Power supply, incl. multi plugs
- T197650; 2-bay battery charger, incl. power supply with multi plugs
- 1196398ACC; Battery
- T911230ACC; Memory card SDHC 4 GB
- 1910423; USB cable Std A <-> Mini-B
- T198509; Cigarette lighter adapter kit, 12 VDC, 1.2 m/3.9 ft.
- 1910582ACC; Video cable

- T198370ACC; Hard transport case for FLIR T/B2xx-4xx
- T198495; Pouch for FLIR T6xx and T4xx series
- 1124545; Pouch
- T198493; Sun shield
- T198499; Neck strap
- T197771ACC; Bluetooth Headset
- T911093; Tool belt
- 19250-100; IR Window 2 in
- 19251-100; IR Window 3 in.
- 19252-100; IR Window 4 in.
- 19250-200; SS IR Window 2 in.
- 19251-200; SS IR Window 3 in.
- 19252-200; SS IR Window 4 in.
- T198586; FLIR Reporter Professional (license only)
- T198584; FLIR Tools
- T198583; FLIR Tools+ (download card incl. license key)
- DSW-10000; FLIR IR Camera Player
- APP-10002; FLIR Tools Mobile (Android Application)
- APP-10004; FLIR Tools (MacOS Application)
- T198697; FLIR ResearchIR Max + HSDR 4 (hardware sec. dev.)
- T199014; FLIR ResearchIR Max + HSDR 4 (printed license key)
- T199044; FLIR ResearchIR Max + HSDR 4 Upgrade (printed license key)
- T198696; FLIR ResearchIR Max 4 (hardware sec. dev.)
- T199013; FLIR ResearchIR Max 4 (printed license key)
- T199043; FLIR ResearchIR Max 4 Upgrade (printed license key)
- T198731; FLIR ResearchIR Standard 4 (hardware sec. dev.)
- T199012; FLIR ResearchIR Standard 4 (printed license key)
- T199042; FLIR ResearchIR Standard 4 Upgrade (printed license key)
- T199233; FLIR Atlas SDK for .NET
- T199234; FLIR Atlas SDK for MATLAB

24.19 FLIR T440bx (incl. Wi-Fi and Ext. cal.) (60 Hz)

P/N: 62103-1702

Rev.: 35946

General description	
The FLIR T440bx is a camera that offers good performance at an affordable price. Excellent ergonomics, a walk-up-and-use interface, and easy communication make the FLIR T440bx a truly user-friendly camera for the beginner or advanced user.	
Benefits:	
<ul style="list-style-type: none"> • Excellent ergonomics: The FLIR T440bx has a tiltable infrared unit and auto-orientation, which make it easy to capture images from any angle comfortably. The small size and low weight of the camera facilitate its use over a full working day. • Affordable performance: The FLIR T440bx is equipped with the innovative Multi Spectral Dynamic Imaging (MSX) feature, which produces an image richer in detail than ever before. You can highlight objects of interest, on both the infrared and the visual image, by sketching or adding predefined stamps directly onto the camera's touch screen. • Extensive communication options: The Wi-Fi connectivity of the FLIR T440bx allows you to connect to smart phones or tablets, for the wireless transfer of images or the remote control of the camera. The Bluetooth-based METERLiNK function transfers readings from external measurement instruments to the infrared image. • Support for UltraMax: When enabling UltraMax in the camera, the resolution of images can be substantially enhanced when importing the images into FLIR Tools. 	
Imaging and optical data	
IR resolution	320 × 240 pixels
MSX resolution	320 × 240 pixels
UltraMax	Yes
Thermal sensitivity/NETD	<30 mK @ +30°C (+86°F)
Field of view (FOV)	25° × 19°
Minimum focus distance	0.4 m (1.31 ft.)
Focal length	18 mm (0.7 in.)
Spatial resolution (IFOV)	1.36 mrad
F-number	1.3
Image frequency	60 Hz
Focus	Automatic (one shot) or manual
Digital zoom	2x, 4x and 8x
Detector data	
Detector type	Focal plane array (FPA), uncooled microbolometer
Spectral range	7.5–13 μm
Detector pitch	25 μm
Image presentation	
Display	Touch screen, 3.5 in. LCD, 320 × 240 pixels
Auto orientation	Automatic landscape or portrait
Image adjustment	Auto or manual
Image presentation modes	
Thermal MSX	Thermal image with enhanced detail presentation
Picture in Picture	Resizable and movable IR area on visual image

Measurement	
Object temperature range	<ul style="list-style-type: none"> • -20°C to +120°C (-4°F to +248°F) • 0°C to +650°C (+32°F to +1202°F)
Accuracy	±2°C (±3.6°F) or 2%, whichever is greater, at 25°C (77°F) nominal.
Measurement analysis	
Spotmeter	5
Area	5 + 5 areas (boxes or circles) with max./min./average (in post-acquisition analysis)
Profile	1 line profile with max/min temp.
Automatic hot/cold detection	Auto hot or cold spotmeter markers within area and profile
Measurement presets	No measurements, Center spot, Hot spot, Cold spot, User preset 1, User preset 2
User presets (in live images)	The user can select and combine measurements from any number of available spots/boxes/circles/profiles/delta
Difference temperature	Delta temperature between measurement functions or reference temperature
Reference temperature	Manually set using difference temperature
Emissivity correction	Variable from 0.01 to 1.0 or selected from materials list
Measurement corrections	Emissivity, reflected temperature, relative humidity, atmospheric temperature, object distance, external IR window compensation
Colors (palettes)	Iron, Rainbow, Rainbow HC, White hot, Black hot, Arctic, Lava
Alarm	
Color Alarm (isotherm)	Above/below/interval
Measurement function alarm	Audible/visual alarms (above/below) on any selected measurement function
Screening	Difference temperature alarm, audible
Humidity alarm	1 humidity alarm, including dew point alarm
Insulation alarm	1 insulation alarm
Set-up	
Set-up commands	Define user presets, Save options, Programmable button, Reset options, Set up camera, Wi-Fi, Compass, Bluetooth, Language, Time & units, Camera information
Service functions	
Camera software update	Use PC software FLIR Tools
Storage of images	
Image storage	Standard JPEG, including digital photo and measurement data, on memory card
Image storage mode	<ul style="list-style-type: none"> • Simultaneous storage of thermal and digital photo in same JPEG file. • Optional to store digital photo as a separate JPEG file.
Time lapse	15 seconds to 24 hours

Image annotations (in still images)	
Voice	60 seconds (via Bluetooth) stored with the image
Text	Add table. Select between predefined templates or create your own in FLIR Tools
Image description	Add short note (stored in JPEG EXIF tag)
Sketch	Draw on thermal/digital photo or add predefined stamps
METERLiNK	Wireless connection (Bluetooth) to: FLIR meters with METERLiNK
Report generation	<ul style="list-style-type: none"> Instant Report (*.pdf file) in camera including IR and visual images Separate PC software with extensive report generation
Geographic Information System	
Compass	Camera direction automatically added to every still image
Video recording in camera	
Non-radiometric IR video recording	MPEG-4 to memory card
Visual video recording	MPEG-4 to memory card
Video streaming	
Radiometric IR video streaming	Full dynamic to PC using USB or to mobile devices using Wi-Fi.
Non-radiometric IR video streaming	<ul style="list-style-type: none"> MPEG-4 using Wi-Fi Uncompressed colorized video using USB
Visual video streaming	<ul style="list-style-type: none"> MPEG-4 using Wi-Fi Uncompressed colorized video using USB
Digital camera	
Built-in digital camera	3.1 Mpixels with LED light (photo as separate image)
Digital camera, focus	Fixed focus
Digital camera, FOV	Adapts to the IR lens
Built-in digital lens data	FOV 53° × 41°
Digital camera, aspect ratio	4:3
Laser pointer	
Laser	Activated by dedicated button
Laser alignment	Position is automatic displayed on the IR image
Laser classification	Class 2
Laser type	Semiconductor AlGaInP diode laser
Laser power	1 mW
Laser wavelength	635 nm (red)
Data communication interfaces	
Interfaces	USB-mini, USB-A, Bluetooth, Wi-Fi, composite video
METERLiNK/Bluetooth	Communication with headset and external sensors

Data communication interfaces	
Wi-Fi	Peer to peer (ad hoc) or infrastructure (network)
SD Card	One card slot for removable SD memory cards
USB	
USB	<ul style="list-style-type: none"> • USB-A: Connect external USB device • USB Mini-B: Data transfer to and from PC / uncompressed colorized video
USB, standard	USB Mini-B: 2.0
Composite video	
Video out	Composite
Video, standard	CVBS (ITU-R-BT.470 PAL/SMPTE 170M NTSC)
Video, connector type	4-pole 3.5 mm jack
Radio	
Wi-Fi	<ul style="list-style-type: none"> • Standard: 802.11 b/g • Frequency range: 2412–2462 MHz • Max. output power: 15 dBm
METERLiNK/Bluetooth	Frequency range: 2402–2480 MHz
Antenna	Internal
Power system	
Battery type	Rechargeable Li ion battery
Battery voltage	3.7 V
Battery capacity	4.4 Ah, at +20°C to +25°C (+68°F to +77°F)
Battery operating time	Approx. 4 hours at +25°C (+77°F) ambient temperature and typical use
Charging system	In camera (AC adapter or 12 V from a vehicle) or 2-bay charger
Charging time	4 h to 90% capacity, charging status indicated by LED's
Charging temperature	0°C to +45°C (+32°F to +113°F)
Power management	Automatic shutdown and sleep mode (user selectable)
AC operation	AC adapter, 90–260 VAC input, 12 V output to camera
Start-up time from sleep mode	Instant on
Environmental data	
Operating temperature range	–15°C to +50°C (+5°F to +122°F)
Storage temperature range	–40°C to +70°C (–40°F to +158°F)
Humidity (operating and storage)	IEC 60068-2-30/24 h 95% relative humidity +25°C to +40°C (+77°F to +104°F) / 2 cycles
EMC	<ul style="list-style-type: none"> • ETSI EN 301 489-1 (radio) • ETSI EN 301 489-17 • EN 61000-6-2 (Immunity) • EN 61000-6-3 (Emission) • FCC 47 CFR Part 15 B (Emission) • ICES-003
Radio spectrum	<ul style="list-style-type: none"> • ETSI EN 300 328 • FCC Part 15.247 • RSS-210

Environmental data	
Magnetic fields	EN 61 000-4-8, Test level 5 for continuous field (severe industrial environment)
Encapsulation	IP 54 (IEC 60529)
Shock	25 g (IEC 60068-2-27)
Vibration	2 g (IEC 60068-2-6)
Safety	EN/UL/CSA/PSE 60950-1
Physical data	
Camera weight, incl. battery	0.855 kg (1.88 lb.)
Camera size (L x W x H)	106 x 201 x 125 mm (4.2 x 7.9 x 4.9 in.), with built-in lens pointing forward
Tripod mounting	UNC ¼"-20 (adapter needed)
Material	<ul style="list-style-type: none"> • Polycarbonate + acrylonitrile butadiene styrene (PC-ABS) • Thixomold magnesium • Thermoplastic elastomer (TPE)
Color	Graphite gray and black
Shipping information	
Packaging, type	Cardboard box
List of contents	<ul style="list-style-type: none"> • Infrared camera with lens • Battery (2 ea.) • Battery charger • Bluetooth headset • Camera lens cap • Calibration certificate • Extended calibration certificate • Hard transport case • Memory card • Neckstrap • Power supply, incl. multi-plugs • Printed documentation • Sunshield • USB cable • Video cable
Packaging, weight	5.7 kg (12.6 lb.)
Packaging, size	495 x 192 x 370 mm (19.49 x 7.56 x 14.57 in.)
EAN-13	7332558012178
UPC-12	845188013271
Country of origin	Sweden

Supplies & accessories:

- 1196961; IR lens, f = 30 mm, 15° incl. case
- 1196960; IR lens, f = 10 mm, 45° incl. case
- T197215; Close-up 4x (100 µm) incl. case
- T197214; Close-up 2x (50 µm) incl. case
- T197408; IR lens, 76 mm (6°) with case and mounting support for T/B-200/400
- T197412; IR lens, 4 mm (90°) with case and mounting support for T/B2xx-4xx
- T197000; High temp. option +1200°C (+2192°F)
- T910814; Power supply, incl. multi plugs
- T197650; 2-bay battery charger, incl. power supply with multi plugs
- 1196398ACC; Battery
- T911230ACC; Memory card SDHC 4 GB
- 1910423; USB cable Std A <-> Mini-B
- T198509; Cigarette lighter adapter kit, 12 VDC, 1.2 m/3.9 ft.
- 1910582ACC; Video cable

- T198370ACC; Hard transport case for FLIR T/B2xx-4xx
- T198495; Pouch for FLIR T6xx and T4xx series
- 1124545; Pouch
- T198493; Sun shield
- T198499; Neck strap
- T197771ACC; Bluetooth Headset
- T911093; Tool belt
- 19250-100; IR Window 2 in
- 19251-100; IR Window 3 in.
- 19252-100; IR Window 4 in.
- 19250-200; SS IR Window 2 in.
- 19251-200; SS IR Window 3 in.
- 19252-200; SS IR Window 4 in.
- T198586; FLIR Reporter Professional (license only)
- T198584; FLIR Tools
- T198583; FLIR Tools+ (download card incl. license key)
- DSW-10000; FLIR IR Camera Player
- APP-10002; FLIR Tools Mobile (Android Application)
- APP-10004; FLIR Tools (MacOS Application)
- T198697; FLIR ResearchIR Max + HSDR 4 (hardware sec. dev.)
- T199014; FLIR ResearchIR Max + HSDR 4 (printed license key)
- T199044; FLIR ResearchIR Max + HSDR 4 Upgrade (printed license key)
- T198696; FLIR ResearchIR Max 4 (hardware sec. dev.)
- T199013; FLIR ResearchIR Max 4 (printed license key)
- T199043; FLIR ResearchIR Max 4 Upgrade (printed license key)
- T198731; FLIR ResearchIR Standard 4 (hardware sec. dev.)
- T199012; FLIR ResearchIR Standard 4 (printed license key)
- T199042; FLIR ResearchIR Standard 4 Upgrade (printed license key)
- T199233; FLIR Atlas SDK for .NET
- T199234; FLIR Atlas SDK for MATLAB

24.20 FLIR T440bx (incl. Wi-Fi)

P/N: 62103-1701

Rev.: 35207

General description	
The FLIR T440bx is a camera that offers good performance at an affordable price. Excellent ergonomics, a walk-up-and-use interface, and easy communication make the FLIR T440bx a truly user-friendly camera for the beginner or advanced user.	
Benefits:	
<ul style="list-style-type: none"> • Excellent ergonomics: The FLIR T440bx has a tiltable infrared unit and auto-orientation, which make it easy to capture images from any angle comfortably. The small size and low weight of the camera facilitate its use over a full working day. • Affordable performance: The FLIR T440bx is equipped with the innovative Multi Spectral Dynamic Imaging (MSX) feature, which produces an image richer in detail than ever before. You can highlight objects of interest, on both the infrared and the visual image, by sketching or adding predefined stamps directly onto the camera's touch screen. • Extensive communication options: The Wi-Fi connectivity of the FLIR T440bx allows you to connect to smart phones or tablets, for the wireless transfer of images or the remote control of the camera. The Bluetooth-based METERLiNK function transfers readings from external measurement instruments to the infrared image. • Support for UltraMax: When enabling UltraMax in the camera, the resolution of images can be substantially enhanced when importing the images into FLIR Tools. 	
Imaging and optical data	
IR resolution	320 × 240 pixels
MSX resolution	320 × 240 pixels
UltraMax	Yes
Thermal sensitivity/NETD	<30 mK @ +30°C (+86°F)
Field of view (FOV)	25° × 19°
Minimum focus distance	0.4 m (1.31 ft.)
Focal length	18 mm (0.7 in.)
Spatial resolution (IFOV)	1.36 mrad
F-number	1.3
Image frequency	60 Hz
Focus	Automatic (one shot) or manual
Digital zoom	2x, 4x and 8x
Detector data	
Detector type	Focal plane array (FPA), uncooled microbolometer
Spectral range	7.5–13 μm
Detector pitch	25 μm
Image presentation	
Display	Touch screen, 3.5 in. LCD, 320 × 240 pixels
Auto orientation	Automatic landscape or portrait
Image adjustment	Auto or manual
Image presentation modes	
Thermal MSX	Thermal image with enhanced detail presentation
Picture in Picture	Resizable and movable IR area on visual image

Measurement	
Object temperature range	<ul style="list-style-type: none"> • -20°C to +120°C (-4°F to +248°F) • 0°C to +650°C (+32°F to +1202°F)
Accuracy	±2°C (±3.6°F) or 2%, whichever is greater, at 25°C (77°F) nominal.
Measurement analysis	
Spotmeter	5
Area	5 + 5 areas (boxes or circles) with max./min./average (in post-acquisition analysis)
Profile	1 line profile with max/min temp.
Automatic hot/cold detection	Auto hot or cold spotmeter markers within area and profile
Measurement presets	No measurements, Center spot, Hot spot, Cold spot, User preset 1, User preset 2
User presets (in live images)	The user can select and combine measurements from any number of available spots/boxes/circles/profiles/delta
Difference temperature	Delta temperature between measurement functions or reference temperature
Reference temperature	Manually set using difference temperature
Emissivity correction	Variable from 0.01 to 1.0 or selected from materials list
Measurement corrections	Emissivity, reflected temperature, relative humidity, atmospheric temperature, object distance, external IR window compensation
Colors (palettes)	Iron, Rainbow, Rainbow HC, White hot, Black hot, Arctic, Lava
Alarm	
Color Alarm (isotherm)	Above/below/interval
Measurement function alarm	Audible/visual alarms (above/below) on any selected measurement function
Screening	Difference temperature alarm, audible
Humidity alarm	1 humidity alarm, including dew point alarm
Insulation alarm	1 insulation alarm
Set-up	
Set-up commands	Define user presets, Save options, Programmable button, Reset options, Set up camera, Wi-Fi, Compass, Bluetooth, Language, Time & units, Camera information
Service functions	
Camera software update	Use PC software FLIR Tools
Storage of images	
Image storage	Standard JPEG, including digital photo and measurement data, on memory card
Image storage mode	<ul style="list-style-type: none"> • Simultaneous storage of thermal and digital photo in same JPEG file. • Optional to store digital photo as a separate JPEG file.
Time lapse	15 seconds to 24 hours

Image annotations (in still images)	
Voice	60 seconds (via Bluetooth) stored with the image
Text	Add table. Select between predefined templates or create your own in FLIR Tools
Image description	Add short note (stored in JPEG EXIF tag)
Sketch	Draw on thermal/digital photo or add predefined stamps
METERLiNK	Wireless connection (Bluetooth) to: FLIR meters with METERLiNK
Report generation	<ul style="list-style-type: none"> Instant Report (*.pdf file) in camera including IR and visual images Separate PC software with extensive report generation
Geographic Information System	
Compass	Camera direction automatically added to every still image
Video recording in camera	
Non-radiometric IR video recording	MPEG-4 to memory card
Visual video recording	MPEG-4 to memory card
Video streaming	
Radiometric IR video streaming	Full dynamic to PC using USB or to mobile devices using Wi-Fi.
Non-radiometric IR video streaming	<ul style="list-style-type: none"> MPEG-4 using Wi-Fi Uncompressed colorized video using USB
Visual video streaming	<ul style="list-style-type: none"> MPEG-4 using Wi-Fi Uncompressed colorized video using USB
Digital camera	
Built-in digital camera	3.1 Mpixels with LED light (photo as separate image)
Digital camera, focus	Fixed focus
Digital camera, FOV	Adapts to the IR lens
Built-in digital lens data	FOV 53° × 41°
Digital camera, aspect ratio	4:3
Laser pointer	
Laser	Activated by dedicated button
Laser alignment	Position is automatic displayed on the IR image
Laser classification	Class 2
Laser type	Semiconductor AlGaInP diode laser
Laser power	1 mW
Laser wavelength	635 nm (red)
Data communication interfaces	
Interfaces	USB-mini, USB-A, Bluetooth, Wi-Fi, composite video
METERLiNK/Bluetooth	Communication with headset and external sensors

Data communication interfaces	
Wi-Fi	Peer to peer (ad hoc) or infrastructure (network)
SD Card	One card slot for removable SD memory cards
USB	
USB	<ul style="list-style-type: none"> • USB-A: Connect external USB device • USB Mini-B: Data transfer to and from PC / uncompressed colorized video
USB, standard	USB Mini-B: 2.0
Composite video	
Video out	Composite
Video, standard	CVBS (ITU-R-BT.470 PAL/SMPTE 170M NTSC)
Video, connector type	4-pole 3.5 mm jack
Radio	
Wi-Fi	<ul style="list-style-type: none"> • Standard: 802.11 b/g • Frequency range: 2412–2462 MHz • Max. output power: 15 dBm
METERLiNK/Bluetooth	Frequency range: 2402–2480 MHz
Antenna	Internal
Power system	
Battery type	Rechargeable Li ion battery
Battery voltage	3.7 V
Battery capacity	4.4 Ah, at +20°C to +25°C (+68°F to +77°F)
Battery operating time	Approx. 4 hours at +25°C (+77°F) ambient temperature and typical use
Charging system	In camera (AC adapter or 12 V from a vehicle) or 2-bay charger
Charging time	4 h to 90% capacity, charging status indicated by LED's
Charging temperature	0°C to +45°C (+32°F to +113°F)
Power management	Automatic shutdown and sleep mode (user selectable)
AC operation	AC adapter, 90–260 VAC input, 12 V output to camera
Start-up time from sleep mode	Instant on
Environmental data	
Operating temperature range	–15°C to +50°C (+5°F to +122°F)
Storage temperature range	–40°C to +70°C (–40°F to +158°F)
Humidity (operating and storage)	IEC 60068-2-30/24 h 95% relative humidity +25°C to +40°C (+77°F to +104°F) / 2 cycles
EMC	<ul style="list-style-type: none"> • ETSI EN 301 489-1 (radio) • ETSI EN 301 489-17 • EN 61000-6-2 (Immunity) • EN 61000-6-3 (Emission) • FCC 47 CFR Part 15 B (Emission) • ICES-003
Radio spectrum	<ul style="list-style-type: none"> • ETSI EN 300 328 • FCC Part 15.247 • RSS-210

Environmental data	
Magnetic fields	EN 61 000-4-8, Test level 5 for continuous field (severe industrial environment)
Encapsulation	IP 54 (IEC 60529)
Shock	25 g (IEC 60068-2-27)
Vibration	2 g (IEC 60068-2-6)
Safety	EN/UL/CSA/PSE 60950-1
Physical data	
Camera weight, incl. battery	0.855 kg (1.88 lb.)
Camera size (L x W x H)	106 x 201 x 125 mm (4.2 x 7.9 x 4.9 in.), with built-in lens pointing forward
Tripod mounting	UNC ¼"-20 (adapter needed)
Material	<ul style="list-style-type: none"> Polycarbonate + acrylonitrile butadiene styrene (PC-ABS) Thixomold magnesium Thermoplastic elastomer (TPE)
Color	Graphite gray and black
Shipping information	
Packaging, type	Cardboard box
List of contents	<ul style="list-style-type: none"> Infrared camera with lens Battery (2 ea.) Battery charger Bluetooth headset Camera lens cap Calibration certificate Printed documentation Hard transport case Memory card Neckstrap Power supply, incl. multi-plugs Sunshield USB cable Video cable
Packaging, weight	5.7 kg (12.6 lb.)
Packaging, size	495 x 192 x 370 mm (19.49 x 7.56 x 14.57 in.)
EAN-13	7332558006535
UPC-12	845188006884
Country of origin	Sweden

Supplies & accessories:

- 1196961; IR lens, f = 30 mm, 15° incl. case
- 1196960; IR lens, f = 10 mm, 45° incl. case
- T197215; Close-up 4x (100 µm) incl. case
- T197214; Close-up 2x (50 µm) incl. case
- T197408; IR lens, 76 mm (6°) with case and mounting support for T/B-200/400
- T197412; IR lens, 4 mm (90°) with case and mounting support for T/B2xx-4xx
- T197000; High temp. option +1200°C (+2192°F)
- T910814; Power supply, incl. multi plugs
- T197650; 2-bay battery charger, incl. power supply with multi plugs
- 1196398ACC; Battery
- T911230ACC; Memory card SDHC 4 GB
- 1910423; USB cable Std A <-> Mini-B
- T198509; Cigarette lighter adapter kit, 12 VDC, 1.2 m/3.9 ft.
- 1910582ACC; Video cable

- T198370ACC; Hard transport case for FLIR T/B2xx-4xx
- T198495; Pouch for FLIR T6xx and T4xx series
- 1124545; Pouch
- T198493; Sun shield
- T198499; Neck strap
- T197771ACC; Bluetooth Headset
- T911093; Tool belt
- 19250-100; IR Window 2 in
- 19251-100; IR Window 3 in.
- 19252-100; IR Window 4 in.
- 19250-200; SS IR Window 2 in.
- 19251-200; SS IR Window 3 in.
- 19252-200; SS IR Window 4 in.
- T198586; FLIR Reporter Professional (license only)
- T198584; FLIR Tools
- T198583; FLIR Tools+ (download card incl. license key)
- DSW-10000; FLIR IR Camera Player
- APP-10002; FLIR Tools Mobile (Android Application)
- APP-10004; FLIR Tools (MacOS Application)
- T198697; FLIR ResearchIR Max + HSDR 4 (hardware sec. dev.)
- T199014; FLIR ResearchIR Max + HSDR 4 (printed license key)
- T199044; FLIR ResearchIR Max + HSDR 4 Upgrade (printed license key)
- T198696; FLIR ResearchIR Max 4 (hardware sec. dev.)
- T199013; FLIR ResearchIR Max 4 (printed license key)
- T199043; FLIR ResearchIR Max 4 Upgrade (printed license key)
- T198731; FLIR ResearchIR Standard 4 (hardware sec. dev.)
- T199012; FLIR ResearchIR Standard 4 (printed license key)
- T199042; FLIR ResearchIR Standard 4 Upgrade (printed license key)
- T199233; FLIR Atlas SDK for .NET
- T199234; FLIR Atlas SDK for MATLAB

24.21 FLIR T440bx 25° and 15° w/case

P/N: 62103-1703

Rev.: 35938

General description	
The FLIR T440bx is a camera that offers good performance at an affordable price. Excellent ergonomics, a walk-up-and-use interface, and easy communication make the FLIR T440bx a truly user-friendly camera for the beginner or advanced user.	
Benefits:	
<ul style="list-style-type: none"> • Excellent ergonomics: The FLIR T440bx has a tiltable infrared unit and auto-orientation, which make it easy to capture images from any angle comfortably. The small size and low weight of the camera facilitate its use over a full working day. • Affordable performance: The FLIR T440bx is equipped with the innovative Multi Spectral Dynamic Imaging (MSX) feature, which produces an image richer in detail than ever before. You can highlight objects of interest, on both the infrared and the visual image, by sketching or adding predefined stamps directly onto the camera's touch screen. • Extensive communication options: The Wi-Fi connectivity of the FLIR T440bx allows you to connect to smart phones or tablets, for the wireless transfer of images or the remote control of the camera. The Bluetooth-based METERLiNK function transfers readings from external measurement instruments to the infrared image. • Support for UltraMax: When enabling UltraMax in the camera, the resolution of images can be substantially enhanced when importing the images into FLIR Tools. 	
Imaging and optical data	
IR resolution	320 × 240 pixels
MSX resolution	320 × 240 pixels
UltraMax	Yes
Thermal sensitivity/NETD	<30 mK @ +30°C (+86°F)
Field of view (FOV)	25° × 19°
Minimum focus distance	0.4 m (1.31 ft.)
Focal length	18 mm (0.7 in.)
Spatial resolution (IFOV)	1.36 mrad
F-number	1.3
Image frequency	60 Hz
Focus	Automatic (one shot) or manual
Digital zoom	2x, 4x and 8x
Detector data	
Detector type	Focal plane array (FPA), uncooled microbolometer
Spectral range	7.5–13 μm
Detector pitch	25 μm
Image presentation	
Display	Touch screen, 3.5 in. LCD, 320 × 240 pixels
Auto orientation	Automatic landscape or portrait
Image adjustment	Auto or manual
Image presentation modes	
Thermal MSX	Thermal image with enhanced detail presentation
Picture in Picture	Resizable and movable IR area on visual image

Measurement	
Object temperature range	<ul style="list-style-type: none"> • -20°C to +120°C (-4°F to +248°F) • 0°C to +650°C (+32°F to +1202°F)
Accuracy	±2°C (±3.6°F) or 2%, whichever is greater, at 25°C (77°F) nominal.
Measurement analysis	
Spotmeter	5
Area	5 + 5 areas (boxes or circles) with max./min./average (in post-acquisition analysis)
Profile	1 line profile with max/min temp.
Automatic hot/cold detection	Auto hot or cold spotmeter markers within area and profile
Measurement presets	No measurements, Center spot, Hot spot, Cold spot, User preset 1, User preset 2
User presets (in live images)	The user can select and combine measurements from any number of available spots/boxes/circles/profiles/delta
Difference temperature	Delta temperature between measurement functions or reference temperature
Reference temperature	Manually set using difference temperature
Emissivity correction	Variable from 0.01 to 1.0 or selected from materials list
Measurement corrections	Emissivity, reflected temperature, relative humidity, atmospheric temperature, object distance, external IR window compensation
Colors (palettes)	Iron, Rainbow, Rainbow HC, White hot, Black hot, Arctic, Lava
Alarm	
Color Alarm (isotherm)	Above/below/interval
Measurement function alarm	Audible/visual alarms (above/below) on any selected measurement function
Screening	Difference temperature alarm, audible
Humidity alarm	1 humidity alarm, including dew point alarm
Insulation alarm	1 insulation alarm
Set-up	
Set-up commands	Define user presets, Save options, Programmable button, Reset options, Set up camera, Wi-Fi, Compass, Bluetooth, Language, Time & units, Camera information
Service functions	
Camera software update	Use PC software FLIR Tools
Storage of images	
Image storage	Standard JPEG, including digital photo and measurement data, on memory card
Image storage mode	<ul style="list-style-type: none"> • Simultaneous storage of thermal and digital photo in same JPEG file. • Optional to store digital photo as a separate JPEG file.
Time lapse	15 seconds to 24 hours

Image annotations (in still images)	
Voice	60 seconds (via Bluetooth) stored with the image
Text	Add table. Select between predefined templates or create your own in FLIR Tools
Image description	Add short note (stored in JPEG EXIF tag)
Sketch	Draw on thermal/digital photo or add predefined stamps
METERLiNK	Wireless connection (Bluetooth) to: FLIR meters with METERLiNK
Report generation	<ul style="list-style-type: none"> Instant Report (*.pdf file) in camera including IR and visual images Separate PC software with extensive report generation
Geographic Information System	
Compass	Camera direction automatically added to every still image
Video recording in camera	
Non-radiometric IR video recording	MPEG-4 to memory card
Visual video recording	MPEG-4 to memory card
Video streaming	
Radiometric IR video streaming	Full dynamic to PC using USB or to mobile devices using Wi-Fi.
Non-radiometric IR video streaming	<ul style="list-style-type: none"> MPEG-4 using Wi-Fi Uncompressed colorized video using USB
Visual video streaming	<ul style="list-style-type: none"> MPEG-4 using Wi-Fi Uncompressed colorized video using USB
Digital camera	
Built-in digital camera	3.1 Mpixels with LED light (photo as separate image)
Digital camera, focus	Fixed focus
Digital camera, FOV	Adapts to the IR lens
Built-in digital lens data	FOV 53° × 41°
Digital camera, aspect ratio	4:3
Laser pointer	
Laser	Activated by dedicated button
Laser alignment	Position is automatic displayed on the IR image
Laser classification	Class 2
Laser type	Semiconductor AlGaInP diode laser
Laser power	1 mW
Laser wavelength	635 nm (red)
Data communication interfaces	
Interfaces	USB-mini, USB-A, Bluetooth, Wi-Fi, composite video
METERLiNK/Bluetooth	Communication with headset and external sensors

Data communication interfaces	
Wi-Fi	Peer to peer (ad hoc) or infrastructure (network)
SD Card	One card slot for removable SD memory cards
USB	
USB	<ul style="list-style-type: none"> • USB-A: Connect external USB device • USB Mini-B: Data transfer to and from PC / uncompressed colorized video
USB, standard	USB Mini-B: 2.0
Composite video	
Video out	Composite
Video, standard	CVBS (ITU-R-BT.470 PAL/SMPTE 170M NTSC)
Video, connector type	4-pole 3.5 mm jack
Radio	
Wi-Fi	<ul style="list-style-type: none"> • Standard: 802.11 b/g • Frequency range: 2412–2462 MHz • Max. output power: 15 dBm
METERLiNK/Bluetooth	Frequency range: 2402–2480 MHz
Antenna	Internal
Power system	
Battery type	Rechargeable Li ion battery
Battery voltage	3.7 V
Battery capacity	4.4 Ah, at +20°C to +25°C (+68°F to +77°F)
Battery operating time	Approx. 4 hours at +25°C (+77°F) ambient temperature and typical use
Charging system	In camera (AC adapter or 12 V from a vehicle) or 2-bay charger
Charging time	4 h to 90% capacity, charging status indicated by LED's
Charging temperature	0°C to +45°C (+32°F to +113°F)
Power management	Automatic shutdown and sleep mode (user selectable)
AC operation	AC adapter, 90–260 VAC input, 12 V output to camera
Start-up time from sleep mode	Instant on
Environmental data	
Operating temperature range	–15°C to +50°C (+5°F to +122°F)
Storage temperature range	–40°C to +70°C (–40°F to +158°F)
Humidity (operating and storage)	IEC 60068-2-30/24 h 95% relative humidity +25°C to +40°C (+77°F to +104°F) / 2 cycles
EMC	<ul style="list-style-type: none"> • ETSI EN 301 489-1 (radio) • ETSI EN 301 489-17 • EN 61000-6-2 (Immunity) • EN 61000-6-3 (Emission) • FCC 47 CFR Part 15 B (Emission) • ICES-003
Radio spectrum	<ul style="list-style-type: none"> • ETSI EN 300 328 • FCC Part 15.247 • RSS-210

Environmental data	
Magnetic fields	EN 61 000-4-8, Test level 5 for continuous field (severe industrial environment)
Encapsulation	IP 54 (IEC 60529)
Shock	25 g (IEC 60068-2-27)
Vibration	2 g (IEC 60068-2-6)
Safety	EN/UL/CSA/PSE 60950-1
Physical data	
Camera weight, incl. battery	0.855 kg (1.88 lb.)
Camera size (L x W x H)	106 x 201 x 125 mm (4.2 x 7.9 x 4.9 in.), with built-in lens pointing forward
Tripod mounting	UNC ¼"-20 (adapter needed)
Material	<ul style="list-style-type: none"> Polycarbonate + acrylonitrile butadiene styrene (PC-ABS) Thixomold magnesium Thermoplastic elastomer (TPE)
Color	Graphite gray and black
Shipping information	
Packaging, type	Cardboard box
List of contents	<ul style="list-style-type: none"> Infrared camera with lens Battery (2 ea.) Battery charger Bluetooth headset Camera lens cap Calibration certificate Hard transport case IR lens, f = 30 mm, 15° Memory card Neckstrap Power supply, incl. multi-plugs Printed documentation Sunshield USB cable Video cable
EAN-13	7332558012185
UPC-12	845188013288
Country of origin	Sweden

Supplies & accessories:

- 1196961; IR lens, f = 30 mm, 15° incl. case
- 1196960; IR lens, f = 10 mm, 45° incl. case
- T197215; Close-up 4x (100 µm) incl. case
- T197214; Close-up 2x (50 µm) incl. case
- T197408; IR lens, 76 mm (6°) with case and mounting support for T/B-200/400
- T197412; IR lens, 4 mm (90°) with case and mounting support for T/B2xx-4xx
- T197000; High temp. option +1200°C (+2192°F)
- T910814; Power supply, incl. multi plugs
- T197650; 2-bay battery charger, incl. power supply with multi plugs
- 1196398ACC; Battery
- T911230ACC; Memory card SDHC 4 GB
- 1910423; USB cable Std A <-> Mini-B
- T198509; Cigarette lighter adapter kit, 12 VDC, 1.2 m/3.9 ft.
- 1910582ACC; Video cable
- T198370ACC; Hard transport case for FLIR T/B2xx-4xx
- T198495; Pouch for FLIR T6xx and T4xx series

- 1124545; Pouch
- T198493; Sun shield
- T198499; Neck strap
- T197771ACC; Bluetooth Headset
- T911093; Tool belt
- 19250-100; IR Window 2 in
- 19251-100; IR Window 3 in.
- 19252-100; IR Window 4 in.
- 19250-200; SS IR Window 2 in.
- 19251-200; SS IR Window 3 in.
- 19252-200; SS IR Window 4 in.
- T198586; FLIR Reporter Professional (license only)
- T198584; FLIR Tools
- T198583; FLIR Tools+ (download card incl. license key)
- DSW-10000; FLIR IR Camera Player
- APP-10002; FLIR Tools Mobile (Android Application)
- APP-10004; FLIR Tools (MacOS Application)
- T198697; FLIR ResearchIR Max + HSDR 4 (hardware sec. dev.)
- T199014; FLIR ResearchIR Max + HSDR 4 (printed license key)
- T199044; FLIR ResearchIR Max + HSDR 4 Upgrade (printed license key)
- T198696; FLIR ResearchIR Max 4 (hardware sec. dev.)
- T199013; FLIR ResearchIR Max 4 (printed license key)
- T199043; FLIR ResearchIR Max 4 Upgrade (printed license key)
- T198731; FLIR ResearchIR Standard 4 (hardware sec. dev.)
- T199012; FLIR ResearchIR Standard 4 (printed license key)
- T199042; FLIR ResearchIR Standard 4 Upgrade (printed license key)
- T199233; FLIR Atlas SDK for .NET
- T199234; FLIR Atlas SDK for MATLAB

24.22 FLIR T440bx 25° and 45° w/case

P/N: 62103-1704

Rev.: 35939

General description	
The FLIR T440bx is a camera that offers good performance at an affordable price. Excellent ergonomics, a walk-up-and-use interface, and easy communication make the FLIR T440bx a truly user-friendly camera for the beginner or advanced user.	
Benefits:	
<ul style="list-style-type: none"> • Excellent ergonomics: The FLIR T440bx has a tiltable infrared unit and auto-orientation, which make it easy to capture images from any angle comfortably. The small size and low weight of the camera facilitate its use over a full working day. • Affordable performance: The FLIR T440bx is equipped with the innovative Multi Spectral Dynamic Imaging (MSX) feature, which produces an image richer in detail than ever before. You can highlight objects of interest, on both the infrared and the visual image, by sketching or adding predefined stamps directly onto the camera's touch screen. • Extensive communication options: The Wi-Fi connectivity of the FLIR T440bx allows you to connect to smart phones or tablets, for the wireless transfer of images or the remote control of the camera. The Bluetooth-based METERLiNK function transfers readings from external measurement instruments to the infrared image. • Support for UltraMax: When enabling UltraMax in the camera, the resolution of images can be substantially enhanced when importing the images into FLIR Tools. 	
Imaging and optical data	
IR resolution	320 × 240 pixels
MSX resolution	320 × 240 pixels
UltraMax	Yes
Thermal sensitivity/NETD	<30 mK @ +30°C (+86°F)
Field of view (FOV)	25° × 19°
Minimum focus distance	0.4 m (1.31 ft.)
Focal length	18 mm (0.7 in.)
Spatial resolution (IFOV)	1.36 mrad
F-number	1.3
Image frequency	60 Hz
Focus	Automatic (one shot) or manual
Digital zoom	2x, 4x and 8x
Detector data	
Detector type	Focal plane array (FPA), uncooled microbolometer
Spectral range	7.5–13 μm
Detector pitch	25 μm
Image presentation	
Display	Touch screen, 3.5 in. LCD, 320 × 240 pixels
Auto orientation	Automatic landscape or portrait
Image adjustment	Auto or manual
Image presentation modes	
Thermal MSX	Thermal image with enhanced detail presentation
Picture in Picture	Resizable and movable IR area on visual image

Measurement	
Object temperature range	<ul style="list-style-type: none"> • -20°C to +120°C (-4°F to +248°F) • 0°C to +650°C (+32°F to +1202°F)
Accuracy	±2°C (±3.6°F) or 2%, whichever is greater, at 25°C (77°F) nominal.
Measurement analysis	
Spotmeter	5
Area	5 + 5 areas (boxes or circles) with max./min./average (in post-acquisition analysis)
Profile	1 line profile with max/min temp.
Automatic hot/cold detection	Auto hot or cold spotmeter markers within area and profile
Measurement presets	No measurements, Center spot, Hot spot, Cold spot, User preset 1, User preset 2
User presets (in live images)	The user can select and combine measurements from any number of available spots/boxes/circles/profiles/delta
Difference temperature	Delta temperature between measurement functions or reference temperature
Reference temperature	Manually set using difference temperature
Emissivity correction	Variable from 0.01 to 1.0 or selected from materials list
Measurement corrections	Emissivity, reflected temperature, relative humidity, atmospheric temperature, object distance, external IR window compensation
Colors (palettes)	Iron, Rainbow, Rainbow HC, White hot, Black hot, Arctic, Lava
Alarm	
Color Alarm (isotherm)	Above/below/interval
Measurement function alarm	Audible/visual alarms (above/below) on any selected measurement function
Screening	Difference temperature alarm, audible
Humidity alarm	1 humidity alarm, including dew point alarm
Insulation alarm	1 insulation alarm
Set-up	
Set-up commands	Define user presets, Save options, Programmable button, Reset options, Set up camera, Wi-Fi, Compass, Bluetooth, Language, Time & units, Camera information
Service functions	
Camera software update	Use PC software FLIR Tools
Storage of images	
Image storage	Standard JPEG, including digital photo and measurement data, on memory card
Image storage mode	<ul style="list-style-type: none"> • Simultaneous storage of thermal and digital photo in same JPEG file. • Optional to store digital photo as a separate JPEG file.
Time lapse	15 seconds to 24 hours

Image annotations (in still images)	
Voice	60 seconds (via Bluetooth) stored with the image
Text	Add table. Select between predefined templates or create your own in FLIR Tools
Image description	Add short note (stored in JPEG EXIF tag)
Sketch	Draw on thermal/digital photo or add predefined stamps
METERLiNK	Wireless connection (Bluetooth) to: FLIR meters with METERLiNK
Report generation	<ul style="list-style-type: none"> Instant Report (*.pdf file) in camera including IR and visual images Separate PC software with extensive report generation
Geographic Information System	
Compass	Camera direction automatically added to every still image
Video recording in camera	
Non-radiometric IR video recording	MPEG-4 to memory card
Visual video recording	MPEG-4 to memory card
Video streaming	
Radiometric IR video streaming	Full dynamic to PC using USB or to mobile devices using Wi-Fi.
Non-radiometric IR video streaming	<ul style="list-style-type: none"> MPEG-4 using Wi-Fi Uncompressed colorized video using USB
Visual video streaming	<ul style="list-style-type: none"> MPEG-4 using Wi-Fi Uncompressed colorized video using USB
Digital camera	
Built-in digital camera	3.1 Mpixels with LED light (photo as separate image)
Digital camera, focus	Fixed focus
Digital camera, FOV	Adapts to the IR lens
Built-in digital lens data	FOV 53° × 41°
Digital camera, aspect ratio	4:3
Laser pointer	
Laser	Activated by dedicated button
Laser alignment	Position is automatic displayed on the IR image
Laser classification	Class 2
Laser type	Semiconductor AlGaInP diode laser
Laser power	1 mW
Laser wavelength	635 nm (red)
Data communication interfaces	
Interfaces	USB-mini, USB-A, Bluetooth, Wi-Fi, composite video
METERLiNK/Bluetooth	Communication with headset and external sensors

Data communication interfaces	
Wi-Fi	Peer to peer (ad hoc) or infrastructure (network)
SD Card	One card slot for removable SD memory cards
USB	
USB	<ul style="list-style-type: none"> • USB-A: Connect external USB device • USB Mini-B: Data transfer to and from PC / uncompressed colorized video
USB, standard	USB Mini-B: 2.0
Composite video	
Video out	Composite
Video, standard	CVBS (ITU-R-BT.470 PAL/SMPTE 170M NTSC)
Video, connector type	4-pole 3.5 mm jack
Radio	
Wi-Fi	<ul style="list-style-type: none"> • Standard: 802.11 b/g • Frequency range: 2412–2462 MHz • Max. output power: 15 dBm
METERLiNK/Bluetooth	Frequency range: 2402–2480 MHz
Antenna	Internal
Power system	
Battery type	Rechargeable Li ion battery
Battery voltage	3.7 V
Battery capacity	4.4 Ah, at +20°C to +25°C (+68°F to +77°F)
Battery operating time	Approx. 4 hours at +25°C (+77°F) ambient temperature and typical use
Charging system	In camera (AC adapter or 12 V from a vehicle) or 2-bay charger
Charging time	4 h to 90% capacity, charging status indicated by LED's
Charging temperature	0°C to +45°C (+32°F to +113°F)
Power management	Automatic shutdown and sleep mode (user selectable)
AC operation	AC adapter, 90–260 VAC input, 12 V output to camera
Start-up time from sleep mode	Instant on
Environmental data	
Operating temperature range	–15°C to +50°C (+5°F to +122°F)
Storage temperature range	–40°C to +70°C (–40°F to +158°F)
Humidity (operating and storage)	IEC 60068-2-30/24 h 95% relative humidity +25°C to +40°C (+77°F to +104°F) / 2 cycles
EMC	<ul style="list-style-type: none"> • ETSI EN 301 489-1 (radio) • ETSI EN 301 489-17 • EN 61000-6-2 (Immunity) • EN 61000-6-3 (Emission) • FCC 47 CFR Part 15 B (Emission) • ICES-003
Radio spectrum	<ul style="list-style-type: none"> • ETSI EN 300 328 • FCC Part 15.247 • RSS-210

Environmental data	
Magnetic fields	EN 61 000-4-8, Test level 5 for continuous field (severe industrial environment)
Encapsulation	IP 54 (IEC 60529)
Shock	25 g (IEC 60068-2-27)
Vibration	2 g (IEC 60068-2-6)
Safety	EN/UL/CSA/PSE 60950-1
Physical data	
Camera weight, incl. battery	0.855 kg (1.88 lb.)
Camera size (L x W x H)	106 x 201 x 125 mm (4.2 x 7.9 x 4.9 in.), with built-in lens pointing forward
Tripod mounting	UNC ¼"-20 (adapter needed)
Material	<ul style="list-style-type: none"> • Polycarbonate + acrylonitrile butadiene styrene (PC-ABS) • Thixomold magnesium • Thermoplastic elastomer (TPE)
Color	Graphite gray and black
Shipping information	
Packaging, type	Cardboard box
List of contents	<ul style="list-style-type: none"> • Infrared camera with lens • Battery (2 ea.) • Battery charger • Bluetooth headset • Camera lens cap • Calibration certificate • Hard transport case • IR lens, f = 10 mm, 45° • Memory card • Neckstrap • Power supply, incl. multi-plugs • Printed documentation • Sunshield • USB cable • Video cable
EAN-13	7332558012192
UPC-12	845188013295
Country of origin	Sweden

Supplies & accessories:

- 1196961; IR lens, f = 30 mm, 15° incl. case
- 1196960; IR lens, f = 10 mm, 45° incl. case
- T197215; Close-up 4x (100 µm) incl. case
- T197214; Close-up 2x (50 µm) incl. case
- T197408; IR lens, 76 mm (6°) with case and mounting support for T/B-200/400
- T197412; IR lens, 4 mm (90°) with case and mounting support for T/B2xx-4xx
- T197000; High temp. option +1200°C (+2192°F)
- T910814; Power supply, incl. multi plugs
- T197650; 2-bay battery charger, incl. power supply with multi plugs
- 1196398ACC; Battery
- T911230ACC; Memory card SDHC 4 GB
- 1910423; USB cable Std A <-> Mini-B
- T198509; Cigarette lighter adapter kit, 12 VDC, 1.2 m/3.9 ft.
- 1910582ACC; Video cable
- T198370ACC; Hard transport case for FLIR T/B2xx-4xx
- T198495; Pouch for FLIR T6xx and T4xx series

- 1124545; Pouch
- T198493; Sun shield
- T198499; Neck strap
- T197771ACC; Bluetooth Headset
- T911093; Tool belt
- 19250-100; IR Window 2 in.
- 19251-100; IR Window 3 in.
- 19252-100; IR Window 4 in.
- 19250-200; SS IR Window 2 in.
- 19251-200; SS IR Window 3 in.
- 19252-200; SS IR Window 4 in.
- T198586; FLIR Reporter Professional (license only)
- T198584; FLIR Tools
- T198583; FLIR Tools+ (download card incl. license key)
- DSW-10000; FLIR IR Camera Player
- APP-10002; FLIR Tools Mobile (Android Application)
- APP-10004; FLIR Tools (MacOS Application)
- T198697; FLIR ResearchIR Max + HSDR 4 (hardware sec. dev.)
- T199014; FLIR ResearchIR Max + HSDR 4 (printed license key)
- T199044; FLIR ResearchIR Max + HSDR 4 Upgrade (printed license key)
- T198696; FLIR ResearchIR Max 4 (hardware sec. dev.)
- T199013; FLIR ResearchIR Max 4 (printed license key)
- T199043; FLIR ResearchIR Max 4 Upgrade (printed license key)
- T198731; FLIR ResearchIR Standard 4 (hardware sec. dev.)
- T199012; FLIR ResearchIR Standard 4 (printed license key)
- T199042; FLIR ResearchIR Standard 4 Upgrade (printed license key)
- T199233; FLIR Atlas SDK for .NET
- T199234; FLIR Atlas SDK for MATLAB

24.23 FLIR T450sc (incl. Wi-Fi)

P/N: 62104-1903

Rev.: 35207

General description	
The FLIR T450sc is a camera that offers good performance at an affordable price. Excellent ergonomics, a walk-up-and-use interface, and easy communication make the FLIR T450sc a truly user-friendly camera for the beginner or advanced user. High accuracy and sensitivity together with radiometric recording and streaming options make the FLIR T450sc well suited for research and development.	
Benefits:	
<ul style="list-style-type: none"> • Tailor made for research and development: The FLIR T450sc has high accuracy and sensitivity to accurately measure the smallest temperature differences. With real-time radiometric recording in the camera, it is possible to capture fast events on the camera's SD card for further analysis by the supplied analysis software. • Excellent ergonomics: The FLIR T450sc has a tiltable infrared unit and auto-orientation, which make it easy to capture images from any angle comfortably. The small size and low weight of the camera facilitate its use over a full working day. • Affordable performance: The FLIR T450sc is equipped with the innovative Multi Spectral Dynamic Imaging (MSX) feature, which produces an image richer in detail than ever before. You can highlight objects of interest, on both the infrared and visual images, by sketching or adding predefined stamps directly onto the camera's touch screen. • Extensive communication options: The Wi-Fi connectivity of the FLIR T450sc allows you to connect to smart phones or tablets for the wireless transfer of images or the remote control of the camera. The Bluetooth-based METERLINK function transfers readings from external measurement instruments to the infrared image. • Support for UltraMax: When enabling UltraMax in the camera, the resolution of images can be substantially enhanced when importing the images into FLIR Tools. 	
Imaging and optical data	
IR resolution	320 × 240 pixels
MSX resolution	320 × 240 pixels
UltraMax	Yes
Thermal sensitivity/NETD	<30 mK @ +30°C (+86°F)
Field of view (FOV)	25° × 19°
Minimum focus distance	0.4 m (1.31 ft.)
Focal length	18 mm (0.7 in.)
Spatial resolution (IFOV)	1.36 mrad
F-number	1.3
Image frequency	60 Hz
Focus	Automatic (one shot) or manual
Digital zoom	2×, 4× and 8×
Detector data	
Detector type	Focal plane array (FPA), uncooled microbolometer
Spectral range	7.5–13 μm
Detector pitch	25 μm
Image presentation	
Display	Touch screen, 3.5 in. LCD, 320 × 240 pixels
Auto orientation	Automatic landscape or portrait
Image adjustment	Auto or manual
Image presentation modes	
Thermal MSX	Thermal image with enhanced detail presentation
Picture in Picture	Resizable and movable IR area on visual image

Measurement	
Object temperature range	<ul style="list-style-type: none"> • -20°C to +120°C (-4°F to +248°F) • 0°C to +650°C (+32°F to +1202°F)
Accuracy	<ul style="list-style-type: none"> • ±1°C (±1.8°F) or ±1% of reading for limited temperature range. • ±2°C (±3.6°F) or 2%, whichever is greater, at 25°C (77°F) nominal.

Measurement analysis	
Spotmeter	5
Area	5 + 5 areas (boxes or circles) with max./min./average (in post-acquisition analysis)
Profile	1 line profile with max/min temp.
Automatic hot/cold detection	Auto hot or cold spotmeter markers within area and profile
Measurement presets	No measurements, Center spot, Hot spot, Cold spot, User preset 1, User preset 2
User presets (in live images)	The user can select and combine measurements from any number of available spots/boxes/circles/profiles/delta
Difference temperature	Delta temperature between measurement functions or reference temperature
Reference temperature	Manually set using difference temperature
Emissivity correction	Variable from 0.01 to 1.0 or selected from materials list
Measurement corrections	Emissivity, reflected temperature, relative humidity, atmospheric temperature, object distance, external IR window compensation
Colors (palettes)	Iron, Rainbow, Rainbow HC, White hot, Black hot, Arctic, Lava

Alarm	
Color Alarm (isotherm)	Above/below/interval
Measurement function alarm	Audible/visual alarms (above/below) on any selected measurement function
Screening	Difference temperature alarm, audible

Set-up	
Set-up commands	Define user presets, Save options, Programmable button, Reset options, Set up camera, Wi-Fi, Compass, Bluetooth, Language, Time & units, Camera information

Service functions	
Camera software update	Use PC software FLIR Tools

Storage of images	
Image storage	Standard JPEG, including digital photo and measurement data, on memory card
Image storage mode	<ul style="list-style-type: none"> • Simultaneous storage of thermal and digital photo in same JPEG file. • Optional to store digital photo as a separate JPEG file.
Time lapse	15 seconds to 24 hours

Image annotations (in still images)	
Voice	60 seconds (via Bluetooth) stored with the image
Text	Add table. Select between predefined templates or create your own in FLIR Tools
Image description	Add short note (stored in JPEG EXIF tag)
Sketch	Draw on thermal/digital photo or add predefined stamps
METERLiNK	Wireless connection (Bluetooth) to: FLIR meters with METERLiNK
Report generation	<ul style="list-style-type: none"> Instant Report (*.pdf file) in camera including IR and visual images Separate PC software with extensive report generation
Geographic Information System	
Compass	Camera direction automatically added to every still image
Video recording in camera	
Radiometric IR video recording	CSQ to memory card
Non-radiometric IR video recording	MPEG-4 to memory card
Visual video recording	MPEG-4 to memory card
Video streaming	
Radiometric IR video streaming	Full dynamic to PC using USB or to mobile devices using Wi-Fi.
Non-radiometric IR video streaming	<ul style="list-style-type: none"> MPEG-4 using Wi-Fi Uncompressed colorized video using USB
Visual video streaming	<ul style="list-style-type: none"> MPEG-4 using Wi-Fi Uncompressed colorized video using USB
Digital camera	
Built-in digital camera	3.1 Mpixels with LED light (photo as separate image)
Digital camera, focus	Fixed focus
Digital camera, FOV	Adapts to the IR lens
Built-in digital lens data	FOV 53° × 41°
Digital camera, aspect ratio	4:3
Laser pointer	
Laser	Activated by dedicated button
Laser alignment	Position is automatic displayed on the IR image
Laser classification	Class 2
Laser type	Semiconductor AlGaInP diode laser
Laser power	1 mW
Laser wavelength	635 nm (red)
Data communication interfaces	
Interfaces	USB-mini, USB-A, Bluetooth, Wi-Fi, composite video
METERLiNK/Bluetooth	Communication with headset and external sensors

Data communication interfaces	
Wi-Fi	Peer to peer (ad hoc) or infrastructure (network)
SD Card	One card slot for removable SD memory cards
USB	
USB	<ul style="list-style-type: none"> • USB-A: Connect external USB device • USB Mini-B: Data transfer to and from PC / uncompressed colorized video
USB, standard	USB Mini-B: 2.0
Composite video	
Video out	Composite
Video, standard	CVBS (ITU-R-BT.470 PAL/SMPTE 170M NTSC)
Video, connector type	4-pole 3.5 mm jack
Radio	
Wi-Fi	<ul style="list-style-type: none"> • Standard: 802.11 b/g • Frequency range: 2412–2462 MHz • Max. output power: 15 dBm
METERLiNK/Bluetooth	Frequency range: 2402–2480 MHz
Antenna	Internal
Power system	
Battery type	Rechargeable Li ion battery
Battery voltage	3.7 V
Battery capacity	4.4 Ah, at +20°C to +25°C (+68°F to +77°F)
Battery operating time	Approx. 4 hours at +25°C (+77°F) ambient temperature and typical use
Charging system	In camera (AC adapter or 12 V from a vehicle) or 2-bay charger
Charging time	4 h to 90% capacity, charging status indicated by LED's
Charging temperature	0°C to +45°C (+32°F to +113°F)
Power management	Automatic shutdown and sleep mode (user selectable)
AC operation	AC adapter, 90–260 VAC input, 12 V output to camera
Start-up time from sleep mode	Instant on
Environmental data	
Operating temperature range	–15°C to +50°C (+5°F to +122°F)
Storage temperature range	–40°C to +70°C (–40°F to +158°F)
Humidity (operating and storage)	IEC 60068-2-30/24 h 95% relative humidity +25°C to +40°C (+77°F to +104°F) / 2 cycles
EMC	<ul style="list-style-type: none"> • ETSI EN 301 489-1 (radio) • ETSI EN 301 489-17 • EN 61000-6-2 (Immunity) • EN 61000-6-3 (Emission) • FCC 47 CFR Part 15 B (Emission) • ICES-003
Radio spectrum	<ul style="list-style-type: none"> • ETSI EN 300 328 • FCC Part 15.247 • RSS-210

Environmental data	
Magnetic fields	EN 61 000-4-8, Test level 5 for continuous field (severe industrial environment)
Encapsulation	IP 54 (IEC 60529)
Shock	25 g (IEC 60068-2-27)
Vibration	2 g (IEC 60068-2-6)
Safety	EN/UL/CSA/PSE 60950-1
Physical data	
Camera weight, incl. battery	0.855 kg (1.88 lb.)
Camera size (L x W x H)	106 x 201 x 125 mm (4.2 x 7.9 x 4.9 in.), with built-in lens pointing forward
Tripod mounting	UNC ¼"-20 (adapter needed)
Material	<ul style="list-style-type: none"> • Polycarbonate + acrylonitrile butadiene styrene (PC-ABS) • Thixomold magnesium • Thermoplastic elastomer (TPE)
Color	Graphite gray and black
Shipping information	
Packaging, type	Cardboard box
List of contents	<ul style="list-style-type: none"> • Infrared camera with lens • Battery (2 ea.) • Battery charger • Bluetooth headset • Camera lens cap • Calibration certificate • FLIR ResearchIR Max 4 • Printed documentation • Hard transport case • Memory card • Neckstrap • Power supply, incl. multi-plugs • Sunshield • USB cable • Video cable
Packaging, weight	6.9 kg (15.2 lb.)
Packaging, size	495 x 192 x 370 mm (19.49 x 7.56 x 14.57 in.)
EAN-13	7332558006559
UPC-12	845188006907
Country of origin	Sweden

Supplies & accessories:

- 1196961; IR lens, f = 30 mm, 15° incl. case
- 1196960; IR lens, f = 10 mm, 45° incl. case
- T197215; Close-up 4x (100 µm) incl. case
- T197214; Close-up 2x (50 µm) incl. case
- T197408; IR lens, 76 mm (6°) with case and mounting support for T/B-200/400
- T197412; IR lens, 4 mm (90°) with case and mounting support for T/B2xx-4xx
- T197000; High temp. option +1200°C (+2192°F)
- T910814; Power supply, incl. multi plugs
- T197650; 2-bay battery charger, incl. power supply with multi plugs
- 1196398ACC; Battery
- T911230ACC; Memory card SDHC 4 GB
- 1910423; USB cable Std A <-> Mini-B
- T198509; Cigarette lighter adapter kit, 12 VDC, 1.2 m/3.9 ft.
- 1910582ACC; Video cable

- T198370ACC; Hard transport case for FLIR T/B2xx-4xx
- T198495; Pouch for FLIR T6xx and T4xx series
- 1124545; Pouch
- T198493; Sun shield
- T198499; Neck strap
- T197771ACC; Bluetooth Headset
- T911093; Tool belt
- 19250-100; IR Window 2 in
- 19251-100; IR Window 3 in.
- 19252-100; IR Window 4 in.
- 19250-200; SS IR Window 2 in.
- 19251-200; SS IR Window 3 in.
- 19252-200; SS IR Window 4 in.
- T198586; FLIR Reporter Professional (license only)
- T198584; FLIR Tools
- T198583; FLIR Tools+ (download card incl. license key)
- DSW-10000; FLIR IR Camera Player
- APP-10002; FLIR Tools Mobile (Android Application)
- APP-10004; FLIR Tools (MacOS Application)
- T198697; FLIR ResearchIR Max + HSDR 4 (hardware sec. dev.)
- T199014; FLIR ResearchIR Max + HSDR 4 (printed license key)
- T199044; FLIR ResearchIR Max + HSDR 4 Upgrade (printed license key)
- T198696; FLIR ResearchIR Max 4 (hardware sec. dev.)
- T199013; FLIR ResearchIR Max 4 (printed license key)
- T199043; FLIR ResearchIR Max 4 Upgrade (printed license key)
- T198731; FLIR ResearchIR Standard 4 (hardware sec. dev.)
- T199012; FLIR ResearchIR Standard 4 (printed license key)
- T199042; FLIR ResearchIR Standard 4 Upgrade (printed license key)
- T199233; FLIR Atlas SDK for .NET
- T199234; FLIR Atlas SDK for MATLAB

24.24 FLIR T450sc 25° and 45° w/case

P/N: 62104-1904

Rev.: 35940

General description	
The FLIR T450sc is a camera that offers good performance at an affordable price. Excellent ergonomics, a walk-up-and-use interface, and easy communication make the FLIR T450sc a truly user-friendly camera for the beginner or advanced user. High accuracy and sensitivity together with radiometric recording and streaming options make the FLIR T450sc well suited for research and development.	
Benefits:	
<ul style="list-style-type: none"> • Tailor made for research and development: The FLIR T450sc has high accuracy and sensitivity to accurately measure the smallest temperature differences. With real-time radiometric recording in the camera, it is possible to capture fast events on the camera's SD card for further analysis by the supplied analysis software. • Excellent ergonomics: The FLIR T450sc has a tiltable infrared unit and auto-orientation, which make it easy to capture images from any angle comfortably. The small size and low weight of the camera facilitate its use over a full working day. • Affordable performance: The FLIR T450sc is equipped with the innovative Multi Spectral Dynamic Imaging (MSX) feature, which produces an image richer in detail than ever before. You can highlight objects of interest, on both the infrared and visual images, by sketching or adding predefined stamps directly onto the camera's touch screen. • Extensive communication options: The Wi-Fi connectivity of the FLIR T450sc allows you to connect to smart phones or tablets for the wireless transfer of images or the remote control of the camera. The Bluetooth-based METERLINK function transfers readings from external measurement instruments to the infrared image. • Support for UltraMax: When enabling UltraMax in the camera, the resolution of images can be substantially enhanced when importing the images into FLIR Tools. 	
Imaging and optical data	
IR resolution	320 × 240 pixels
MSX resolution	320 × 240 pixels
UltraMax	Yes
Thermal sensitivity/NETD	<30 mK @ +30°C (+86°F)
Field of view (FOV)	25° × 19°
Minimum focus distance	0.4 m (1.31 ft.)
Focal length	18 mm (0.7 in.)
Spatial resolution (IFOV)	1.36 mrad
F-number	1.3
Image frequency	60 Hz
Focus	Automatic (one shot) or manual
Digital zoom	2×, 4× and 8×
Detector data	
Detector type	Focal plane array (FPA), uncooled microbolometer
Spectral range	7.5–13 μm
Detector pitch	25 μm
Image presentation	
Display	Touch screen, 3.5 in. LCD, 320 × 240 pixels
Auto orientation	Automatic landscape or portrait
Image adjustment	Auto or manual
Image presentation modes	
Thermal MSX	Thermal image with enhanced detail presentation
Picture in Picture	Resizable and movable IR area on visual image

Measurement	
Object temperature range	<ul style="list-style-type: none"> • -20°C to +120°C (-4°F to +248°F) • 0°C to +650°C (+32°F to +1202°F)
Accuracy	<ul style="list-style-type: none"> • $\pm 1^\circ\text{C}$ ($\pm 1.8^\circ\text{F}$) or $\pm 1\%$ of reading for limited temperature range. • $\pm 2^\circ\text{C}$ ($\pm 3.6^\circ\text{F}$) or 2%, whichever is greater, at 25°C (77°F) nominal.

Measurement analysis	
Spotmeter	5
Area	5 + 5 areas (boxes or circles) with max./min./average (in post-acquisition analysis)
Profile	1 line profile with max/min temp.
Automatic hot/cold detection	Auto hot or cold spotmeter markers within area and profile
Measurement presets	No measurements, Center spot, Hot spot, Cold spot, User preset 1, User preset 2
User presets (in live images)	The user can select and combine measurements from any number of available spots/boxes/circles/profiles/delta
Difference temperature	Delta temperature between measurement functions or reference temperature
Reference temperature	Manually set using difference temperature
Emissivity correction	Variable from 0.01 to 1.0 or selected from materials list
Measurement corrections	Emissivity, reflected temperature, relative humidity, atmospheric temperature, object distance, external IR window compensation
Colors (palettes)	Iron, Rainbow, Rainbow HC, White hot, Black hot, Arctic, Lava

Alarm	
Color Alarm (isotherm)	Above/below/interval
Measurement function alarm	Audible/visual alarms (above/below) on any selected measurement function
Screening	Difference temperature alarm, audible

Set-up	
Set-up commands	Define user presets, Save options, Programmable button, Reset options, Set up camera, Wi-Fi, Compass, Bluetooth, Language, Time & units, Camera information

Service functions	
Camera software update	Use PC software FLIR Tools

Storage of images	
Image storage	Standard JPEG, including digital photo and measurement data, on memory card
Image storage mode	<ul style="list-style-type: none"> • Simultaneous storage of thermal and digital photo in same JPEG file. • Optional to store digital photo as a separate JPEG file.
Time lapse	15 seconds to 24 hours

Image annotations (in still images)	
Voice	60 seconds (via Bluetooth) stored with the image
Text	Add table. Select between predefined templates or create your own in FLIR Tools
Image description	Add short note (stored in JPEG EXIF tag)
Sketch	Draw on thermal/digital photo or add predefined stamps
METERLiNK	Wireless connection (Bluetooth) to: FLIR meters with METERLiNK
Report generation	<ul style="list-style-type: none"> Instant Report (*.pdf file) in camera including IR and visual images Separate PC software with extensive report generation
Geographic Information System	
Compass	Camera direction automatically added to every still image
Video recording in camera	
Radiometric IR video recording	CSQ to memory card
Non-radiometric IR video recording	MPEG-4 to memory card
Visual video recording	MPEG-4 to memory card
Video streaming	
Radiometric IR video streaming	Full dynamic to PC using USB or to mobile devices using Wi-Fi.
Non-radiometric IR video streaming	<ul style="list-style-type: none"> MPEG-4 using Wi-Fi Uncompressed colorized video using USB
Visual video streaming	<ul style="list-style-type: none"> MPEG-4 using Wi-Fi Uncompressed colorized video using USB
Digital camera	
Built-in digital camera	3.1 Mpixels with LED light (photo as separate image)
Digital camera, focus	Fixed focus
Digital camera, FOV	Adapts to the IR lens
Built-in digital lens data	FOV 53° × 41°
Digital camera, aspect ratio	4:3
Laser pointer	
Laser	Activated by dedicated button
Laser alignment	Position is automatic displayed on the IR image
Laser classification	Class 2
Laser type	Semiconductor AlGaInP diode laser
Laser power	1 mW
Laser wavelength	635 nm (red)
Data communication interfaces	
Interfaces	USB-mini, USB-A, Bluetooth, Wi-Fi, composite video
METERLiNK/Bluetooth	Communication with headset and external sensors

Data communication interfaces	
Wi-Fi	Peer to peer (ad hoc) or infrastructure (network)
SD Card	One card slot for removable SD memory cards
USB	
USB	<ul style="list-style-type: none"> • USB-A: Connect external USB device • USB Mini-B: Data transfer to and from PC / uncompressed colorized video
USB, standard	USB Mini-B: 2.0
Composite video	
Video out	Composite
Video, standard	CVBS (ITU-R-BT.470 PAL/SMPTE 170M NTSC)
Video, connector type	4-pole 3.5 mm jack
Radio	
Wi-Fi	<ul style="list-style-type: none"> • Standard: 802.11 b/g • Frequency range: 2412–2462 MHz • Max. output power: 15 dBm
METERLiNK/Bluetooth	Frequency range: 2402–2480 MHz
Antenna	Internal
Power system	
Battery type	Rechargeable Li ion battery
Battery voltage	3.7 V
Battery capacity	4.4 Ah, at +20°C to +25°C (+68°F to +77°F)
Battery operating time	Approx. 4 hours at +25°C (+77°F) ambient temperature and typical use
Charging system	In camera (AC adapter or 12 V from a vehicle) or 2-bay charger
Charging time	4 h to 90% capacity, charging status indicated by LED's
Charging temperature	0°C to +45°C (+32°F to +113°F)
Power management	Automatic shutdown and sleep mode (user selectable)
AC operation	AC adapter, 90–260 VAC input, 12 V output to camera
Start-up time from sleep mode	Instant on
Environmental data	
Operating temperature range	–15°C to +50°C (+5°F to +122°F)
Storage temperature range	–40°C to +70°C (–40°F to +158°F)
Humidity (operating and storage)	IEC 60068-2-30/24 h 95% relative humidity +25°C to +40°C (+77°F to +104°F) / 2 cycles
EMC	<ul style="list-style-type: none"> • ETSI EN 301 489-1 (radio) • ETSI EN 301 489-17 • EN 61000-6-2 (Immunity) • EN 61000-6-3 (Emission) • FCC 47 CFR Part 15 B (Emission) • ICES-003
Radio spectrum	<ul style="list-style-type: none"> • ETSI EN 300 328 • FCC Part 15.247 • RSS-210

Environmental data	
Magnetic fields	EN 61 000-4-8, Test level 5 for continuous field (severe industrial environment)
Encapsulation	IP 54 (IEC 60529)
Shock	25 g (IEC 60068-2-27)
Vibration	2 g (IEC 60068-2-6)
Safety	EN/UL/CSA/PSE 60950-1
Physical data	
Camera weight, incl. battery	0.855 kg (1.88 lb.)
Camera size (L x W x H)	106 x 201 x 125 mm (4.2 x 7.9 x 4.9 in.), with built-in lens pointing forward
Tripod mounting	UNC ¼"-20 (adapter needed)
Material	<ul style="list-style-type: none"> • Polycarbonate + acrylonitrile butadiene styrene (PC-ABS) • Thixomold magnesium • Thermoplastic elastomer (TPE)
Color	Graphite gray and black
Shipping information	
Packaging, type	Cardboard box
List of contents	<ul style="list-style-type: none"> • Infrared camera with lens • Battery (2 ea.) • Battery charger • Bluetooth headset • Camera lens cap • Calibration certificate • FLIR ResearchIR Max 4 • Hard transport case • IR lens, f = 10 mm, 45° • Memory card • Neckstrap • Power supply, incl. multi-plugs • Printed documentation • Sunshield • USB cable • Video cable
EAN-13	7332558012208
UPC-12	845188013301
Country of origin	Sweden

Supplies & accessories:

- 1196961; IR lens, f = 30 mm, 15° incl. case
- 1196960; IR lens, f = 10 mm, 45° incl. case
- T197215; Close-up 4x (100 µm) incl. case
- T197214; Close-up 2x (50 µm) incl. case
- T197408; IR lens, 76 mm (6°) with case and mounting support for T/B-200/400
- T197412; IR lens, 4 mm (90°) with case and mounting support for T/B2xx-4xx
- T197000; High temp. option +1200°C (+2192°F)
- T910814; Power supply, incl. multi plugs
- T197650; 2-bay battery charger, incl. power supply with multi plugs
- 1196398ACC; Battery
- T911230ACC; Memory card SDHC 4 GB
- 1910423; USB cable Std A <-> Mini-B
- T198509; Cigarette lighter adapter kit, 12 VDC, 1.2 m/3.9 ft.
- 1910582ACC; Video cable
- T198370ACC; Hard transport case for FLIR T/B2xx-4xx
- T198495; Pouch for FLIR T6xx and T4xx series

- 1124545; Pouch
- T198493; Sun shield
- T198499; Neck strap
- T197771ACC; Bluetooth Headset
- T911093; Tool belt
- 19250-100; IR Window 2 in.
- 19251-100; IR Window 3 in.
- 19252-100; IR Window 4 in.
- 19250-200; SS IR Window 2 in.
- 19251-200; SS IR Window 3 in.
- 19252-200; SS IR Window 4 in.
- T198586; FLIR Reporter Professional (license only)
- T198584; FLIR Tools
- T198583; FLIR Tools+ (download card incl. license key)
- DSW-10000; FLIR IR Camera Player
- APP-10002; FLIR Tools Mobile (Android Application)
- APP-10004; FLIR Tools (MacOS Application)
- T198697; FLIR ResearchIR Max + HSDR 4 (hardware sec. dev.)
- T199014; FLIR ResearchIR Max + HSDR 4 (printed license key)
- T199044; FLIR ResearchIR Max + HSDR 4 Upgrade (printed license key)
- T198696; FLIR ResearchIR Max 4 (hardware sec. dev.)
- T199013; FLIR ResearchIR Max 4 (printed license key)
- T199043; FLIR ResearchIR Max 4 Upgrade (printed license key)
- T198731; FLIR ResearchIR Standard 4 (hardware sec. dev.)
- T199012; FLIR ResearchIR Standard 4 (printed license key)
- T199042; FLIR ResearchIR Standard 4 Upgrade (printed license key)
- T199233; FLIR Atlas SDK for .NET
- T199234; FLIR Atlas SDK for MATLAB

24.25 FLIR T460 (incl. Wi-Fi and Ext. cal.)

P/N: 62104-2802

Rev.: 35947

General description	
The FLIR T460 is a camera that offers good performance at an affordable price. Excellent ergonomics and a walk-up-and-use interface make the FLIR T460 a truly user-friendly camera for the beginner or advanced user.	
Benefits:	
<ul style="list-style-type: none"> • Excellent ergonomics: The FLIR T460 has a tiltable infrared unit and auto-orientation, which make it easy to capture images from any angle comfortably. The small size and low weight of the camera facilitate its use over a full working day. • Affordable performance: The FLIR T460 is equipped with the innovative Multi Spectral Dynamic Imaging (MSX) feature, which produces an image richer in detail than ever before. You can highlight objects of interest, on both the infrared and visual images, by sketching or adding predefined stamps directly onto the camera's touch screen. • Extensive communication options: The Wi-Fi connectivity of the FLIR T460 allows you to connect to smart phones or tablets for the wireless transfer of images or the remote control of the camera. The Bluetooth-based METERLiNK function transfers readings from external measurement instruments to the infrared image. • Support for UltraMax: When enabling UltraMax in the camera, the resolution of images can be substantially enhanced when importing the images into FLIR Tools. 	
Imaging and optical data	
IR resolution	320 × 240 pixels
MSX resolution	320 × 240 pixels
UltraMax	Yes
Thermal sensitivity/NETD	<30 mK @ +30°C (+86°F)
Field of view (FOV)	25° × 19°
Minimum focus distance	0.4 m (1.31 ft.)
Focal length	18 mm (0.7 in.)
Spatial resolution (IFOV)	1.36 mrad
F-number	1.3
Image frequency	60 Hz
Focus	Automatic (one shot) or manual
Digital zoom	2x, 4x and 8x
Detector data	
Detector type	Focal plane array (FPA), uncooled microbolometer
Spectral range	7.5–13 μm
Detector pitch	25 μm
Image presentation	
Display	Touch screen, 3.5 in. LCD, 320 × 240 pixels
Auto orientation	Automatic landscape or portrait
Image adjustment	Auto or manual
Image presentation modes	
Thermal MSX	Thermal image with enhanced detail presentation
Picture in Picture	Resizable and movable IR area on visual image

Measurement	
Object temperature range	<ul style="list-style-type: none"> • -20°C to +120°C (-4°F to +248°F) • 0°C to +650°C (+32°F to +1202°F) • +250°C to +1500°C (+482°F to +2732°F)
Accuracy	<ul style="list-style-type: none"> • ±1°C (±1.8°F) or ±1% of reading for limited temperature range. • ±2°C (±3.6°F) or 2%, whichever is greater, at 25°C (77°F) nominal.
Measurement analysis	
Spotmeter	5
Area	5 + 5 areas (boxes or circles) with max./min./average (in post-acquisition analysis)
Profile	1 line profile with max/min temp.
Automatic hot/cold detection	Auto hot or cold spotmeter markers within area and profile
Measurement presets	No measurements, Center spot, Hot spot, Cold spot, User preset 1, User preset 2
User presets (in live images)	The user can select and combine measurements from any number of available spots/boxes/circles/profiles/delta
Difference temperature	Delta temperature between measurement functions or reference temperature
Reference temperature	Manually set using difference temperature
Emissivity correction	Variable from 0.01 to 1.0 or selected from materials list
Measurement corrections	Emissivity, reflected temperature, relative humidity, atmospheric temperature, object distance, external IR window compensation
Colors (palettes)	Iron, Rainbow, Rainbow HC, White hot, Black hot, Arctic, Lava
Alarm	
Color Alarm (isotherm)	Above/below/interval
Measurement function alarm	Audible/visual alarms (above/below) on any selected measurement function
Screening	Difference temperature alarm, audible
Set-up	
Set-up commands	Define user presets, Save options, Programmable button, Reset options, Set up camera, Wi-Fi, Compass, Bluetooth, Language, Time & units, Camera information
Service functions	
Camera software update	Use PC software FLIR Tools
Storage of images	
Image storage	Standard JPEG, including digital photo and measurement data, on memory card
Image storage mode	<ul style="list-style-type: none"> • Simultaneous storage of thermal and digital photo in same JPEG file. • Optional to store digital photo as a separate JPEG file.
Time lapse	15 seconds to 24 hours

Image annotations (in still images)	
Voice	60 seconds (via Bluetooth) stored with the image
Text	Add table. Select between predefined templates or create your own in FLIR Tools
Image description	Add short note (stored in JPEG EXIF tag)
Sketch	Draw on thermal/digital photo or add predefined stamps
METERLiNK	Wireless connection (Bluetooth) to: FLIR meters with METERLiNK
Report generation	<ul style="list-style-type: none"> Instant Report (*.pdf file) in camera including IR and visual images Separate PC software with extensive report generation
Geographic Information System	
Compass	Camera direction automatically added to every still image
Video recording in camera	
Radiometric IR video recording	CSQ to memory card
Non-radiometric IR video recording	MPEG-4 to memory card
Visual video recording	MPEG-4 to memory card
Video streaming	
Radiometric IR video streaming	Full dynamic to PC using USB or to mobile devices using Wi-Fi.
Non-radiometric IR video streaming	<ul style="list-style-type: none"> MPEG-4 using Wi-Fi Uncompressed colorized video using USB
Visual video streaming	<ul style="list-style-type: none"> MPEG-4 using Wi-Fi Uncompressed colorized video using USB
Digital camera	
Built-in digital camera	3.1 Mpixels with LED light (photo as separate image)
Digital camera, focus	Fixed focus
Digital camera, FOV	Adapts to the IR lens
Built-in digital lens data	FOV 53° × 41°
Digital camera, aspect ratio	4:3
Laser pointer	
Laser	Activated by dedicated button
Laser alignment	Position is automatic displayed on the IR image
Laser classification	Class 2
Laser type	Semiconductor AlGaInP diode laser
Laser power	1 mW
Laser wavelength	635 nm (red)
Data communication interfaces	
Interfaces	USB-mini, USB-A, Bluetooth, Wi-Fi, composite video
METERLiNK/Bluetooth	Communication with headset and external sensors

Data communication interfaces	
Wi-Fi	Peer to peer (ad hoc) or infrastructure (network)
SD Card	One card slot for removable SD memory cards
USB	
USB	<ul style="list-style-type: none"> • USB-A: Connect external USB device • USB Mini-B: Data transfer to and from PC / uncompressed colorized video
USB, standard	USB Mini-B: 2.0
Composite video	
Video out	Composite
Video, standard	CVBS (ITU-R-BT.470 PAL/SMPTE 170M NTSC)
Video, connector type	4-pole 3.5 mm jack
Radio	
Wi-Fi	<ul style="list-style-type: none"> • Standard: 802.11 b/g • Frequency range: 2412–2462 MHz • Max. output power: 15 dBm
METERLiNK/Bluetooth	Frequency range: 2402–2480 MHz
Antenna	Internal
Power system	
Battery type	Rechargeable Li ion battery
Battery voltage	3.7 V
Battery capacity	4.4 Ah, at +20°C to +25°C (+68°F to +77°F)
Battery operating time	Approx. 4 hours at +25°C (+77°F) ambient temperature and typical use
Charging system	In camera (AC adapter or 12 V from a vehicle) or 2-bay charger
Charging time	4 h to 90% capacity, charging status indicated by LED's
Charging temperature	0°C to +45°C (+32°F to +113°F)
Power management	Automatic shutdown and sleep mode (user selectable)
AC operation	AC adapter, 90–260 VAC input, 12 V output to camera
Start-up time from sleep mode	Instant on
Environmental data	
Operating temperature range	–15°C to +50°C (+5°F to +122°F)
Storage temperature range	–40°C to +70°C (–40°F to +158°F)
Humidity (operating and storage)	IEC 60068-2-30/24 h 95% relative humidity +25°C to +40°C (+77°F to +104°F) / 2 cycles
EMC	<ul style="list-style-type: none"> • ETSI EN 301 489-1 (radio) • ETSI EN 301 489-17 • EN 61000-6-2 (Immunity) • EN 61000-6-3 (Emission) • FCC 47 CFR Part 15 B (Emission) • ICES-003
Radio spectrum	<ul style="list-style-type: none"> • ETSI EN 300 328 • FCC Part 15.247 • RSS-210

Environmental data	
Magnetic fields	EN 61 000-4-8, Test level 5 for continuous field (severe industrial environment)
Encapsulation	IP 54 (IEC 60529)
Shock	25 g (IEC 60068-2-27)
Vibration	2 g (IEC 60068-2-6)
Safety	EN/UL/CSA/PSE 60950-1
Physical data	
Camera weight, incl. battery	0.855 kg (1.88 lb.)
Camera size (L x W x H)	106 x 201 x 125 mm (4.2 x 7.9 x 4.9 in.), with built-in lens pointing forward
Tripod mounting	UNC ¼"-20 (adapter needed)
Material	<ul style="list-style-type: none"> • Polycarbonate + acrylonitrile butadiene styrene (PC-ABS) • Thixomold magnesium • Thermoplastic elastomer (TPE)
Color	Graphite gray and black
Shipping information	
Packaging, type	Cardboard box
List of contents	<ul style="list-style-type: none"> • Infrared camera with lens • Battery (2 ea.) • Battery charger • Bluetooth headset • Camera lens cap • Calibration certificate • Extended calibration certificate • Hard transport case • Memory card • Neckstrap • Power supply, incl. multi-plugs • Printed documentation • Sunshield • USB cable • Video cable
Packaging, weight	5.7 kg (12.6 lb.)
Packaging, size	495 x 192 x 370 mm (19.49 x 7.56 x 14.57 in.)
EAN-13	7332558012215
UPC-12	845188013318
Country of origin	Sweden

Supplies & accessories:

- 1196961; IR lens, f = 30 mm, 15° incl. case
- 1196960; IR lens, f = 10 mm, 45° incl. case
- T197215; Close-up 4x (100 µm) incl. case
- T197214; Close-up 2x (50 µm) incl. case
- T197408; IR lens, 76 mm (6°) with case and mounting support for T/B-200/400
- T197412; IR lens, 4 mm (90°) with case and mounting support for T/B2xx-4xx
- T197000; High temp. option +1200°C (+2192°F)
- T910814; Power supply, incl. multi plugs
- T197650; 2-bay battery charger, incl. power supply with multi plugs
- 1196398ACC; Battery
- T911230ACC; Memory card SDHC 4 GB
- 1910423; USB cable Std A <-> Mini-B
- T198509; Cigarette lighter adapter kit, 12 VDC, 1.2 m/3.9 ft.
- 1910582ACC; Video cable

- T198370ACC; Hard transport case for FLIR T/B2xx-4xx
- T198495; Pouch for FLIR T6xx and T4xx series
- 1124545; Pouch
- T198493; Sun shield
- T198499; Neck strap
- T197771ACC; Bluetooth Headset
- T911093; Tool belt
- 19250-100; IR Window 2 in
- 19251-100; IR Window 3 in.
- 19252-100; IR Window 4 in.
- 19250-200; SS IR Window 2 in.
- 19251-200; SS IR Window 3 in.
- 19252-200; SS IR Window 4 in.
- T198586; FLIR Reporter Professional (license only)
- T198584; FLIR Tools
- T198583; FLIR Tools+ (download card incl. license key)
- DSW-10000; FLIR IR Camera Player
- APP-10002; FLIR Tools Mobile (Android Application)
- APP-10004; FLIR Tools (MacOS Application)
- T199233; FLIR Atlas SDK for .NET
- T199234; FLIR Atlas SDK for MATLAB

24.26 FLIR T460 (incl. Wi-Fi)

P/N: 62104-2801

Rev.: 35207

General description	
The FLIR T460 is a camera that offers good performance at an affordable price. Excellent ergonomics and a walk-up-and-use interface make the FLIR T460 a truly user-friendly camera for the beginner or advanced user.	
Benefits:	
<ul style="list-style-type: none"> • Excellent ergonomics: The FLIR T460 has a tiltable infrared unit and auto-orientation, which make it easy to capture images from any angle comfortably. The small size and low weight of the camera facilitate its use over a full working day. • Affordable performance: The FLIR T460 is equipped with the innovative Multi Spectral Dynamic Imaging (MSX) feature, which produces an image richer in detail than ever before. You can highlight objects of interest, on both the infrared and visual images, by sketching or adding predefined stamps directly onto the camera's touch screen. • Extensive communication options: The Wi-Fi connectivity of the FLIR T460 allows you to connect to smart phones or tablets for the wireless transfer of images or the remote control of the camera. The Bluetooth-based METERLiNK function transfers readings from external measurement instruments to the infrared image. • Support for UltraMax: When enabling UltraMax in the camera, the resolution of images can be substantially enhanced when importing the images into FLIR Tools. 	
Imaging and optical data	
IR resolution	320 × 240 pixels
MSX resolution	320 × 240 pixels
UltraMax	Yes
Thermal sensitivity/NETD	<30 mK @ +30°C (+86°F)
Field of view (FOV)	25° × 19°
Minimum focus distance	0.4 m (1.31 ft.)
Focal length	18 mm (0.7 in.)
Spatial resolution (IFOV)	1.36 mrad
F-number	1.3
Image frequency	60 Hz
Focus	Automatic (one shot) or manual
Digital zoom	2x, 4x and 8x
Detector data	
Detector type	Focal plane array (FPA), uncooled microbolometer
Spectral range	7.5–13 μm
Detector pitch	25 μm
Image presentation	
Display	Touch screen, 3.5 in. LCD, 320 × 240 pixels
Auto orientation	Automatic landscape or portrait
Image adjustment	Auto or manual
Image presentation modes	
Thermal MSX	Thermal image with enhanced detail presentation
Picture in Picture	Resizable and movable IR area on visual image

Measurement	
Object temperature range	<ul style="list-style-type: none"> • -20°C to +120°C (-4°F to +248°F) • 0°C to +650°C (+32°F to +1202°F) • +250°C to +1500°C (+482°F to +2732°F)
Accuracy	<ul style="list-style-type: none"> • ±1°C (±1.8°F) or ±1% of reading for limited temperature range. • ±2°C (±3.6°F) or 2%, whichever is greater, at 25°C (77°F) nominal.
Measurement analysis	
Spotmeter	5
Area	5 + 5 areas (boxes or circles) with max./min./average (in post-acquisition analysis)
Profile	1 line profile with max/min temp.
Automatic hot/cold detection	Auto hot or cold spotmeter markers within area and profile
Measurement presets	No measurements, Center spot, Hot spot, Cold spot, User preset 1, User preset 2
User presets (in live images)	The user can select and combine measurements from any number of available spots/boxes/circles/profiles/delta
Difference temperature	Delta temperature between measurement functions or reference temperature
Reference temperature	Manually set using difference temperature
Emissivity correction	Variable from 0.01 to 1.0 or selected from materials list
Measurement corrections	Emissivity, reflected temperature, relative humidity, atmospheric temperature, object distance, external IR window compensation
Colors (palettes)	Iron, Rainbow, Rainbow HC, White hot, Black hot, Arctic, Lava
Alarm	
Color Alarm (isotherm)	Above/below/interval
Measurement function alarm	Audible/visual alarms (above/below) on any selected measurement function
Screening	Difference temperature alarm, audible
Set-up	
Set-up commands	Define user presets, Save options, Programmable button, Reset options, Set up camera, Wi-Fi, Compass, Bluetooth, Language, Time & units, Camera information
Service functions	
Camera software update	Use PC software FLIR Tools
Storage of images	
Image storage	Standard JPEG, including digital photo and measurement data, on memory card
Image storage mode	<ul style="list-style-type: none"> • Simultaneous storage of thermal and digital photo in same JPEG file. • Optional to store digital photo as a separate JPEG file.
Time lapse	15 seconds to 24 hours

Image annotations (in still images)	
Voice	60 seconds (via Bluetooth) stored with the image
Text	Add table. Select between predefined templates or create your own in FLIR Tools
Image description	Add short note (stored in JPEG EXIF tag)
Sketch	Draw on thermal/digital photo or add predefined stamps
METERLiNK	Wireless connection (Bluetooth) to: FLIR meters with METERLiNK
Report generation	<ul style="list-style-type: none"> Instant Report (*.pdf file) in camera including IR and visual images Separate PC software with extensive report generation
Geographic Information System	
Compass	Camera direction automatically added to every still image
Video recording in camera	
Radiometric IR video recording	CSQ to memory card
Non-radiometric IR video recording	MPEG-4 to memory card
Visual video recording	MPEG-4 to memory card
Video streaming	
Radiometric IR video streaming	Full dynamic to PC using USB or to mobile devices using Wi-Fi.
Non-radiometric IR video streaming	<ul style="list-style-type: none"> MPEG-4 using Wi-Fi Uncompressed colorized video using USB
Visual video streaming	<ul style="list-style-type: none"> MPEG-4 using Wi-Fi Uncompressed colorized video using USB
Digital camera	
Built-in digital camera	3.1 Mpixels with LED light (photo as separate image)
Digital camera, focus	Fixed focus
Digital camera, FOV	Adapts to the IR lens
Built-in digital lens data	FOV 53° × 41°
Digital camera, aspect ratio	4:3
Laser pointer	
Laser	Activated by dedicated button
Laser alignment	Position is automatic displayed on the IR image
Laser classification	Class 2
Laser type	Semiconductor AlGaInP diode laser
Laser power	1 mW
Laser wavelength	635 nm (red)
Data communication interfaces	
Interfaces	USB-mini, USB-A, Bluetooth, Wi-Fi, composite video
METERLiNK/Bluetooth	Communication with headset and external sensors

Data communication interfaces	
Wi-Fi	Peer to peer (ad hoc) or infrastructure (network)
SD Card	One card slot for removable SD memory cards
USB	
USB	<ul style="list-style-type: none"> • USB-A: Connect external USB device • USB Mini-B: Data transfer to and from PC / uncompressed colorized video
USB, standard	USB Mini-B: 2.0
Composite video	
Video out	Composite
Video, standard	CVBS (ITU-R-BT.470 PAL/SMPTE 170M NTSC)
Video, connector type	4-pole 3.5 mm jack
Radio	
Wi-Fi	<ul style="list-style-type: none"> • Standard: 802.11 b/g • Frequency range: 2412–2462 MHz • Max. output power: 15 dBm
METERLiNK/Bluetooth	Frequency range: 2402–2480 MHz
Antenna	Internal
Power system	
Battery type	Rechargeable Li ion battery
Battery voltage	3.7 V
Battery capacity	4.4 Ah, at +20°C to +25°C (+68°F to +77°F)
Battery operating time	Approx. 4 hours at +25°C (+77°F) ambient temperature and typical use
Charging system	In camera (AC adapter or 12 V from a vehicle) or 2-bay charger
Charging time	4 h to 90% capacity, charging status indicated by LED's
Charging temperature	0°C to +45°C (+32°F to +113°F)
Power management	Automatic shutdown and sleep mode (user selectable)
AC operation	AC adapter, 90–260 VAC input, 12 V output to camera
Start-up time from sleep mode	Instant on
Environmental data	
Operating temperature range	–15°C to +50°C (+5°F to +122°F)
Storage temperature range	–40°C to +70°C (–40°F to +158°F)
Humidity (operating and storage)	IEC 60068-2-30/24 h 95% relative humidity +25°C to +40°C (+77°F to +104°F) / 2 cycles
EMC	<ul style="list-style-type: none"> • ETSI EN 301 489-1 (radio) • ETSI EN 301 489-17 • EN 61000-6-2 (Immunity) • EN 61000-6-3 (Emission) • FCC 47 CFR Part 15 B (Emission) • ICES-003
Radio spectrum	<ul style="list-style-type: none"> • ETSI EN 300 328 • FCC Part 15.247 • RSS-210

Environmental data	
Magnetic fields	EN 61 000-4-8, Test level 5 for continuous field (severe industrial environment)
Encapsulation	IP 54 (IEC 60529)
Shock	25 g (IEC 60068-2-27)
Vibration	2 g (IEC 60068-2-6)
Safety	EN/UL/CSA/PSE 60950-1
Physical data	
Camera weight, incl. battery	0.855 kg (1.88 lb.)
Camera size (L x W x H)	106 x 201 x 125 mm (4.2 x 7.9 x 4.9 in.), with built-in lens pointing forward
Tripod mounting	UNC ¼"-20 (adapter needed)
Material	<ul style="list-style-type: none"> Polycarbonate + acrylonitrile butadiene styrene (PC-ABS) Thixomold magnesium Thermoplastic elastomer (TPE)
Color	Graphite gray and black
Shipping information	
Packaging, type	Cardboard box
List of contents	<ul style="list-style-type: none"> Infrared camera with lens Battery (2 ea.) Battery charger Bluetooth headset Camera lens cap Calibration certificate Printed documentation Hard transport case Memory card Neckstrap Power supply, incl. multi-plugs Sunshield USB cable Video cable
Packaging, weight	5.7 kg (12.6 lb.)
Packaging, size	495 x 192 x 370 mm (19.49 x 7.56 x 14.57 in.)
EAN-13	7332558008706
UPC-12	845188009229
Country of origin	Sweden

Supplies & accessories:

- 1196961; IR lens, f = 30 mm, 15° incl. case
- 1196960; IR lens, f = 10 mm, 45° incl. case
- T197215; Close-up 4x (100 µm) incl. case
- T197214; Close-up 2x (50 µm) incl. case
- T197408; IR lens, 76 mm (6°) with case and mounting support for T/B-200/400
- T197412; IR lens, 4 mm (90°) with case and mounting support for T/B2xx-4xx
- T197000; High temp. option +1200°C (+2192°F)
- T910814; Power supply, incl. multi plugs
- T197650; 2-bay battery charger, incl. power supply with multi plugs
- 1196398ACC; Battery
- T911230ACC; Memory card SDHC 4 GB
- 1910423; USB cable Std A <-> Mini-B
- T198509; Cigarette lighter adapter kit, 12 VDC, 1.2 m/3.9 ft.
- 1910582ACC; Video cable

- T198370ACC; Hard transport case for FLIR T/B2xx-4xx
- T198495; Pouch for FLIR T6xx and T4xx series
- 1124545; Pouch
- T198493; Sun shield
- T198499; Neck strap
- T197771ACC; Bluetooth Headset
- T911093; Tool belt
- 19250-100; IR Window 2 in
- 19251-100; IR Window 3 in.
- 19252-100; IR Window 4 in.
- 19250-200; SS IR Window 2 in.
- 19251-200; SS IR Window 3 in.
- 19252-200; SS IR Window 4 in.
- T198586; FLIR Reporter Professional (license only)
- T198584; FLIR Tools
- T198583; FLIR Tools+ (download card incl. license key)
- DSW-10000; FLIR IR Camera Player
- APP-10002; FLIR Tools Mobile (Android Application)
- APP-10004; FLIR Tools (MacOS Application)
- T199233; FLIR Atlas SDK for .NET
- T199234; FLIR Atlas SDK for MATLAB

24.27 FLIR T460 25° and 15° w/case

P/N: 62104-2803

Rev.: 35941

General description	
The FLIR T460 is a camera that offers good performance at an affordable price. Excellent ergonomics and a walk-up-and-use interface make the FLIR T460 a truly user-friendly camera for the beginner or advanced user.	
Benefits:	
<ul style="list-style-type: none"> • Excellent ergonomics: The FLIR T460 has a tiltable infrared unit and auto-orientation, which make it easy to capture images from any angle comfortably. The small size and low weight of the camera facilitate its use over a full working day. • Affordable performance: The FLIR T460 is equipped with the innovative Multi Spectral Dynamic Imaging (MSX) feature, which produces an image richer in detail than ever before. You can highlight objects of interest, on both the infrared and visual images, by sketching or adding predefined stamps directly onto the camera's touch screen. • Extensive communication options: The Wi-Fi connectivity of the FLIR T460 allows you to connect to smart phones or tablets for the wireless transfer of images or the remote control of the camera. The Bluetooth-based METERLiNK function transfers readings from external measurement instruments to the infrared image. • Support for UltraMax: When enabling UltraMax in the camera, the resolution of images can be substantially enhanced when importing the images into FLIR Tools. 	
Imaging and optical data	
IR resolution	320 × 240 pixels
MSX resolution	320 × 240 pixels
UltraMax	Yes
Thermal sensitivity/NETD	<30 mK @ +30°C (+86°F)
Field of view (FOV)	25° × 19°
Minimum focus distance	0.4 m (1.31 ft.)
Focal length	18 mm (0.7 in.)
Spatial resolution (IFOV)	1.36 mrad
F-number	1.3
Image frequency	60 Hz
Focus	Automatic (one shot) or manual
Digital zoom	2x, 4x and 8x
Detector data	
Detector type	Focal plane array (FPA), uncooled microbolometer
Spectral range	7.5–13 μm
Detector pitch	25 μm
Image presentation	
Display	Touch screen, 3.5 in. LCD, 320 × 240 pixels
Auto orientation	Automatic landscape or portrait
Image adjustment	Auto or manual
Image presentation modes	
Thermal MSX	Thermal image with enhanced detail presentation
Picture in Picture	Resizable and movable IR area on visual image

Measurement	
Object temperature range	<ul style="list-style-type: none"> • -20°C to +120°C (-4°F to +248°F) • 0°C to +650°C (+32°F to +1202°F) • +250°C to +1500°C (+482°F to +2732°F)
Accuracy	<ul style="list-style-type: none"> • ±1°C (±1.8°F) or ±1% of reading for limited temperature range. • ±2°C (±3.6°F) or 2%, whichever is greater, at 25°C (77°F) nominal.
Measurement analysis	
Spotmeter	5
Area	5 + 5 areas (boxes or circles) with max./min./average (in post-acquisition analysis)
Profile	1 line profile with max/min temp.
Automatic hot/cold detection	Auto hot or cold spotmeter markers within area and profile
Measurement presets	No measurements, Center spot, Hot spot, Cold spot, User preset 1, User preset 2
User presets (in live images)	The user can select and combine measurements from any number of available spots/boxes/circles/profiles/delta
Difference temperature	Delta temperature between measurement functions or reference temperature
Reference temperature	Manually set using difference temperature
Emissivity correction	Variable from 0.01 to 1.0 or selected from materials list
Measurement corrections	Emissivity, reflected temperature, relative humidity, atmospheric temperature, object distance, external IR window compensation
Colors (palettes)	Iron, Rainbow, Rainbow HC, White hot, Black hot, Arctic, Lava
Alarm	
Color Alarm (isotherm)	Above/below/interval
Measurement function alarm	Audible/visual alarms (above/below) on any selected measurement function
Screening	Difference temperature alarm, audible
Set-up	
Set-up commands	Define user presets, Save options, Programmable button, Reset options, Set up camera, Wi-Fi, Compass, Bluetooth, Language, Time & units, Camera information
Service functions	
Camera software update	Use PC software FLIR Tools
Storage of images	
Image storage	Standard JPEG, including digital photo and measurement data, on memory card
Image storage mode	<ul style="list-style-type: none"> • Simultaneous storage of thermal and digital photo in same JPEG file. • Optional to store digital photo as a separate JPEG file.
Time lapse	15 seconds to 24 hours

Image annotations (in still images)	
Voice	60 seconds (via Bluetooth) stored with the image
Text	Add table. Select between predefined templates or create your own in FLIR Tools
Image description	Add short note (stored in JPEG EXIF tag)
Sketch	Draw on thermal/digital photo or add predefined stamps
METERLiNK	Wireless connection (Bluetooth) to: FLIR meters with METERLiNK
Report generation	<ul style="list-style-type: none"> Instant Report (*.pdf file) in camera including IR and visual images Separate PC software with extensive report generation
Geographic Information System	
Compass	Camera direction automatically added to every still image
Video recording in camera	
Radiometric IR video recording	CSQ to memory card
Non-radiometric IR video recording	MPEG-4 to memory card
Visual video recording	MPEG-4 to memory card
Video streaming	
Radiometric IR video streaming	Full dynamic to PC using USB or to mobile devices using Wi-Fi.
Non-radiometric IR video streaming	<ul style="list-style-type: none"> MPEG-4 using Wi-Fi Uncompressed colorized video using USB
Visual video streaming	<ul style="list-style-type: none"> MPEG-4 using Wi-Fi Uncompressed colorized video using USB
Digital camera	
Built-in digital camera	3.1 Mpixels with LED light (photo as separate image)
Digital camera, focus	Fixed focus
Digital camera, FOV	Adapts to the IR lens
Built-in digital lens data	FOV 53° × 41°
Digital camera, aspect ratio	4:3
Laser pointer	
Laser	Activated by dedicated button
Laser alignment	Position is automatic displayed on the IR image
Laser classification	Class 2
Laser type	Semiconductor AlGaInP diode laser
Laser power	1 mW
Laser wavelength	635 nm (red)
Data communication interfaces	
Interfaces	USB-mini, USB-A, Bluetooth, Wi-Fi, composite video
METERLiNK/Bluetooth	Communication with headset and external sensors

Data communication interfaces	
Wi-Fi	Peer to peer (ad hoc) or infrastructure (network)
SD Card	One card slot for removable SD memory cards
USB	
USB	<ul style="list-style-type: none"> • USB-A: Connect external USB device • USB Mini-B: Data transfer to and from PC / uncompressed colorized video
USB, standard	USB Mini-B: 2.0
Composite video	
Video out	Composite
Video, standard	CVBS (ITU-R-BT.470 PAL/SMPTE 170M NTSC)
Video, connector type	4-pole 3.5 mm jack
Radio	
Wi-Fi	<ul style="list-style-type: none"> • Standard: 802.11 b/g • Frequency range: 2412–2462 MHz • Max. output power: 15 dBm
METERLiNK/Bluetooth	Frequency range: 2402–2480 MHz
Antenna	Internal
Power system	
Battery type	Rechargeable Li ion battery
Battery voltage	3.7 V
Battery capacity	4.4 Ah, at +20°C to +25°C (+68°F to +77°F)
Battery operating time	Approx. 4 hours at +25°C (+77°F) ambient temperature and typical use
Charging system	In camera (AC adapter or 12 V from a vehicle) or 2-bay charger
Charging time	4 h to 90% capacity, charging status indicated by LED's
Charging temperature	0°C to +45°C (+32°F to +113°F)
Power management	Automatic shutdown and sleep mode (user selectable)
AC operation	AC adapter, 90–260 VAC input, 12 V output to camera
Start-up time from sleep mode	Instant on
Environmental data	
Operating temperature range	–15°C to +50°C (+5°F to +122°F)
Storage temperature range	–40°C to +70°C (–40°F to +158°F)
Humidity (operating and storage)	IEC 60068-2-30/24 h 95% relative humidity +25°C to +40°C (+77°F to +104°F) / 2 cycles
EMC	<ul style="list-style-type: none"> • ETSI EN 301 489-1 (radio) • ETSI EN 301 489-17 • EN 61000-6-2 (Immunity) • EN 61000-6-3 (Emission) • FCC 47 CFR Part 15 B (Emission) • ICES-003
Radio spectrum	<ul style="list-style-type: none"> • ETSI EN 300 328 • FCC Part 15.247 • RSS-210

Environmental data	
Magnetic fields	EN 61 000-4-8, Test level 5 for continuous field (severe industrial environment)
Encapsulation	IP 54 (IEC 60529)
Shock	25 g (IEC 60068-2-27)
Vibration	2 g (IEC 60068-2-6)
Safety	EN/UL/CSA/PSE 60950-1
Physical data	
Camera weight, incl. battery	0.855 kg (1.88 lb.)
Camera size (L x W x H)	106 x 201 x 125 mm (4.2 x 7.9 x 4.9 in.), with built-in lens pointing forward
Tripod mounting	UNC ¼"-20 (adapter needed)
Material	<ul style="list-style-type: none"> • Polycarbonate + acrylonitrile butadiene styrene (PC-ABS) • Thixomold magnesium • Thermoplastic elastomer (TPE)
Color	Graphite gray and black
Shipping information	
Packaging, type	Cardboard box
List of contents	<ul style="list-style-type: none"> • Infrared camera with lens • Battery (2 ea.) • Battery charger • Bluetooth headset • Camera lens cap • Calibration certificate • Hard transport case • IR lens, f = 30 mm, 15° • Memory card • Neckstrap • Power supply, incl. multi-plugs • Printed documentation • Sunshield • USB cable • Video cable
EAN-13	7332558012222
UPC-12	845188013325
Country of origin	Sweden

Supplies & accessories:

- 1196961; IR lens, f = 30 mm, 15° incl. case
- 1196960; IR lens, f = 10 mm, 45° incl. case
- T197215; Close-up 4x (100 µm) incl. case
- T197214; Close-up 2x (50 µm) incl. case
- T197408; IR lens, 76 mm (6°) with case and mounting support for T/B-200/400
- T197412; IR lens, 4 mm (90°) with case and mounting support for T/B2xx-4xx
- T197000; High temp. option +1200°C (+2192°F)
- T910814; Power supply, incl. multi plugs
- T197650; 2-bay battery charger, incl. power supply with multi plugs
- 1196398ACC; Battery
- T911230ACC; Memory card SDHC 4 GB
- 1910423; USB cable Std A <-> Mini-B
- T198509; Cigarette lighter adapter kit, 12 VDC, 1.2 m/3.9 ft.
- 1910582ACC; Video cable
- T198370ACC; Hard transport case for FLIR T/B2xx-4xx
- T198495; Pouch for FLIR T6xx and T4xx series

- 1124545; Pouch
- T198493; Sun shield
- T198499; Neck strap
- T197771ACC; Bluetooth Headset
- T911093; Tool belt
- 19250-100; IR Window 2 in
- 19251-100; IR Window 3 in.
- 19252-100; IR Window 4 in.
- 19250-200; SS IR Window 2 in.
- 19251-200; SS IR Window 3 in.
- 19252-200; SS IR Window 4 in.
- T198586; FLIR Reporter Professional (license only)
- T198584; FLIR Tools
- T198583; FLIR Tools+ (download card incl. license key)
- DSW-10000; FLIR IR Camera Player
- APP-10002; FLIR Tools Mobile (Android Application)
- APP-10004; FLIR Tools (MacOS Application)
- T199233; FLIR Atlas SDK for .NET
- T199234; FLIR Atlas SDK for MATLAB

24.28 FLIR T460 25° and 45° w/case

P/N: 62104-2804

Rev.: 35942

General description	
The FLIR T460 is a camera that offers good performance at an affordable price. Excellent ergonomics and a walk-up-and-use interface make the FLIR T460 a truly user-friendly camera for the beginner or advanced user.	
Benefits:	
<ul style="list-style-type: none"> • Excellent ergonomics: The FLIR T460 has a tiltable infrared unit and auto-orientation, which make it easy to capture images from any angle comfortably. The small size and low weight of the camera facilitate its use over a full working day. • Affordable performance: The FLIR T460 is equipped with the innovative Multi Spectral Dynamic Imaging (MSX) feature, which produces an image richer in detail than ever before. You can highlight objects of interest, on both the infrared and visual images, by sketching or adding predefined stamps directly onto the camera's touch screen. • Extensive communication options: The Wi-Fi connectivity of the FLIR T460 allows you to connect to smart phones or tablets for the wireless transfer of images or the remote control of the camera. The Bluetooth-based METERLiNK function transfers readings from external measurement instruments to the infrared image. • Support for UltraMax: When enabling UltraMax in the camera, the resolution of images can be substantially enhanced when importing the images into FLIR Tools. 	
Imaging and optical data	
IR resolution	320 × 240 pixels
MSX resolution	320 × 240 pixels
UltraMax	Yes
Thermal sensitivity/NETD	<30 mK @ +30°C (+86°F)
Field of view (FOV)	25° × 19°
Minimum focus distance	0.4 m (1.31 ft.)
Focal length	18 mm (0.7 in.)
Spatial resolution (IFOV)	1.36 mrad
F-number	1.3
Image frequency	60 Hz
Focus	Automatic (one shot) or manual
Digital zoom	2x, 4x and 8x
Detector data	
Detector type	Focal plane array (FPA), uncooled microbolometer
Spectral range	7.5–13 μm
Detector pitch	25 μm
Image presentation	
Display	Touch screen, 3.5 in. LCD, 320 × 240 pixels
Auto orientation	Automatic landscape or portrait
Image adjustment	Auto or manual
Image presentation modes	
Thermal MSX	Thermal image with enhanced detail presentation
Picture in Picture	Resizable and movable IR area on visual image

Measurement	
Object temperature range	<ul style="list-style-type: none"> • -20°C to +120°C (-4°F to +248°F) • 0°C to +650°C (+32°F to +1202°F) • +250°C to +1500°C (+482°F to +2732°F)
Accuracy	<ul style="list-style-type: none"> • ±1°C (±1.8°F) or ±1% of reading for limited temperature range. • ±2°C (±3.6°F) or 2%, whichever is greater, at 25°C (77°F) nominal.
Measurement analysis	
Spotmeter	5
Area	5 + 5 areas (boxes or circles) with max./min./average (in post-acquisition analysis)
Profile	1 line profile with max/min temp.
Automatic hot/cold detection	Auto hot or cold spotmeter markers within area and profile
Measurement presets	No measurements, Center spot, Hot spot, Cold spot, User preset 1, User preset 2
User presets (in live images)	The user can select and combine measurements from any number of available spots/boxes/circles/profiles/delta
Difference temperature	Delta temperature between measurement functions or reference temperature
Reference temperature	Manually set using difference temperature
Emissivity correction	Variable from 0.01 to 1.0 or selected from materials list
Measurement corrections	Emissivity, reflected temperature, relative humidity, atmospheric temperature, object distance, external IR window compensation
Colors (palettes)	Iron, Rainbow, Rainbow HC, White hot, Black hot, Arctic, Lava
Alarm	
Color Alarm (isotherm)	Above/below/interval
Measurement function alarm	Audible/visual alarms (above/below) on any selected measurement function
Screening	Difference temperature alarm, audible
Set-up	
Set-up commands	Define user presets, Save options, Programmable button, Reset options, Set up camera, Wi-Fi, Compass, Bluetooth, Language, Time & units, Camera information
Service functions	
Camera software update	Use PC software FLIR Tools
Storage of images	
Image storage	Standard JPEG, including digital photo and measurement data, on memory card
Image storage mode	<ul style="list-style-type: none"> • Simultaneous storage of thermal and digital photo in same JPEG file. • Optional to store digital photo as a separate JPEG file.
Time lapse	15 seconds to 24 hours

Image annotations (in still images)	
Voice	60 seconds (via Bluetooth) stored with the image
Text	Add table. Select between predefined templates or create your own in FLIR Tools
Image description	Add short note (stored in JPEG EXIF tag)
Sketch	Draw on thermal/digital photo or add predefined stamps
METERLiNK	Wireless connection (Bluetooth) to: FLIR meters with METERLiNK
Report generation	<ul style="list-style-type: none"> Instant Report (*.pdf file) in camera including IR and visual images Separate PC software with extensive report generation
Geographic Information System	
Compass	Camera direction automatically added to every still image
Video recording in camera	
Radiometric IR video recording	CSQ to memory card
Non-radiometric IR video recording	MPEG-4 to memory card
Visual video recording	MPEG-4 to memory card
Video streaming	
Radiometric IR video streaming	Full dynamic to PC using USB or to mobile devices using Wi-Fi.
Non-radiometric IR video streaming	<ul style="list-style-type: none"> MPEG-4 using Wi-Fi Uncompressed colorized video using USB
Visual video streaming	<ul style="list-style-type: none"> MPEG-4 using Wi-Fi Uncompressed colorized video using USB
Digital camera	
Built-in digital camera	3.1 Mpixels with LED light (photo as separate image)
Digital camera, focus	Fixed focus
Digital camera, FOV	Adapts to the IR lens
Built-in digital lens data	FOV 53° × 41°
Digital camera, aspect ratio	4:3
Laser pointer	
Laser	Activated by dedicated button
Laser alignment	Position is automatic displayed on the IR image
Laser classification	Class 2
Laser type	Semiconductor AlGaInP diode laser
Laser power	1 mW
Laser wavelength	635 nm (red)
Data communication interfaces	
Interfaces	USB-mini, USB-A, Bluetooth, Wi-Fi, composite video
METERLiNK/Bluetooth	Communication with headset and external sensors

Data communication interfaces	
Wi-Fi	Peer to peer (ad hoc) or infrastructure (network)
SD Card	One card slot for removable SD memory cards
USB	
USB	<ul style="list-style-type: none"> • USB-A: Connect external USB device • USB Mini-B: Data transfer to and from PC / uncompressed colorized video
USB, standard	USB Mini-B: 2.0
Composite video	
Video out	Composite
Video, standard	CVBS (ITU-R-BT.470 PAL/SMPTE 170M NTSC)
Video, connector type	4-pole 3.5 mm jack
Radio	
Wi-Fi	<ul style="list-style-type: none"> • Standard: 802.11 b/g • Frequency range: 2412–2462 MHz • Max. output power: 15 dBm
METERLiNK/Bluetooth	Frequency range: 2402–2480 MHz
Antenna	Internal
Power system	
Battery type	Rechargeable Li ion battery
Battery voltage	3.7 V
Battery capacity	4.4 Ah, at +20°C to +25°C (+68°F to +77°F)
Battery operating time	Approx. 4 hours at +25°C (+77°F) ambient temperature and typical use
Charging system	In camera (AC adapter or 12 V from a vehicle) or 2-bay charger
Charging time	4 h to 90% capacity, charging status indicated by LED's
Charging temperature	0°C to +45°C (+32°F to +113°F)
Power management	Automatic shutdown and sleep mode (user selectable)
AC operation	AC adapter, 90–260 VAC input, 12 V output to camera
Start-up time from sleep mode	Instant on
Environmental data	
Operating temperature range	–15°C to +50°C (+5°F to +122°F)
Storage temperature range	–40°C to +70°C (–40°F to +158°F)
Humidity (operating and storage)	IEC 60068-2-30/24 h 95% relative humidity +25°C to +40°C (+77°F to +104°F) / 2 cycles
EMC	<ul style="list-style-type: none"> • ETSI EN 301 489-1 (radio) • ETSI EN 301 489-17 • EN 61000-6-2 (Immunity) • EN 61000-6-3 (Emission) • FCC 47 CFR Part 15 B (Emission) • ICES-003
Radio spectrum	<ul style="list-style-type: none"> • ETSI EN 300 328 • FCC Part 15.247 • RSS-210

Environmental data	
Magnetic fields	EN 61 000-4-8, Test level 5 for continuous field (severe industrial environment)
Encapsulation	IP 54 (IEC 60529)
Shock	25 g (IEC 60068-2-27)
Vibration	2 g (IEC 60068-2-6)
Safety	EN/UL/CSA/PSE 60950-1
Physical data	
Camera weight, incl. battery	0.855 kg (1.88 lb.)
Camera size (L x W x H)	106 x 201 x 125 mm (4.2 x 7.9 x 4.9 in.), with built-in lens pointing forward
Tripod mounting	UNC ¼"-20 (adapter needed)
Material	<ul style="list-style-type: none"> • Polycarbonate + acrylonitrile butadiene styrene (PC-ABS) • Thixomold magnesium • Thermoplastic elastomer (TPE)
Color	Graphite gray and black
Shipping information	
Packaging, type	Cardboard box
List of contents	<ul style="list-style-type: none"> • Infrared camera with lens • Battery (2 ea.) • Battery charger • Bluetooth headset • Camera lens cap • Calibration certificate • Hard transport case • IR lens, f = 10 mm, 45° • Memory card • Neckstrap • Power supply, incl. multi-plugs • Printed documentation • Sunshield • USB cable • Video cable
EAN-13	7332558012239
UPC-12	845188013332
Country of origin	Sweden

Supplies & accessories:

- 1196961; IR lens, f = 30 mm, 15° incl. case
- 1196960; IR lens, f = 10 mm, 45° incl. case
- T197215; Close-up 4x (100 µm) incl. case
- T197214; Close-up 2x (50 µm) incl. case
- T197408; IR lens, 76 mm (6°) with case and mounting support for T/B-200/400
- T197412; IR lens, 4 mm (90°) with case and mounting support for T/B2xx-4xx
- T197000; High temp. option +1200°C (+2192°F)
- T910814; Power supply, incl. multi plugs
- T197650; 2-bay battery charger, incl. power supply with multi plugs
- 1196398ACC; Battery
- T911230ACC; Memory card SDHC 4 GB
- 1910423; USB cable Std A <-> Mini-B
- T198509; Cigarette lighter adapter kit, 12 VDC, 1.2 m/3.9 ft.
- 1910582ACC; Video cable
- T198370ACC; Hard transport case for FLIR T/B2xx-4xx
- T198495; Pouch for FLIR T6xx and T4xx series

- 1124545; Pouch
- T198493; Sun shield
- T198499; Neck strap
- T197771ACC; Bluetooth Headset
- T911093; Tool belt
- 19250-100; IR Window 2 in
- 19251-100; IR Window 3 in.
- 19252-100; IR Window 4 in.
- 19250-200; SS IR Window 2 in.
- 19251-200; SS IR Window 3 in.
- 19252-200; SS IR Window 4 in.
- T198586; FLIR Reporter Professional (license only)
- T198584; FLIR Tools
- T198583; FLIR Tools+ (download card incl. license key)
- DSW-10000; FLIR IR Camera Player
- APP-10002; FLIR Tools Mobile (Android Application)
- APP-10004; FLIR Tools (MacOS Application)
- T199233; FLIR Atlas SDK for .NET
- T199234; FLIR Atlas SDK for MATLAB

25.1 Pin configuration for USB Mini-B connector

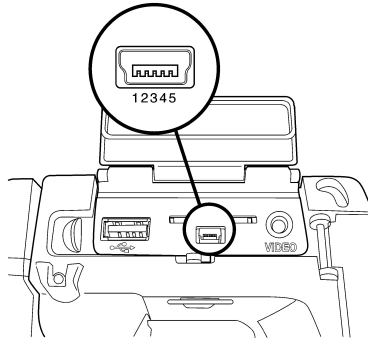

1. +5 V (out)
2. USB -
3. USB +
4. N/C
5. Ground

25.2 Pin configuration for video connector

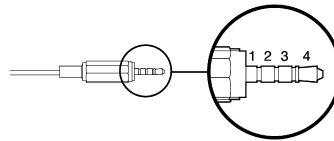

1. Audio right
2. Ground
3. Video out
4. Audio left

25.3 Pin configuration for USB-A connector

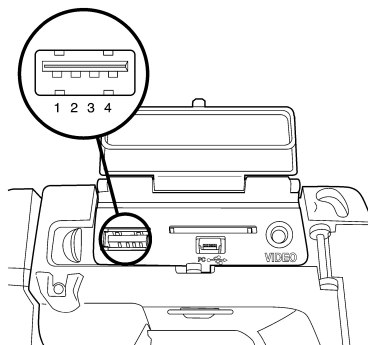

1. +5 V (in)
2. USB -
3. USB +
4. Ground

25.4 Pin configuration for power connector

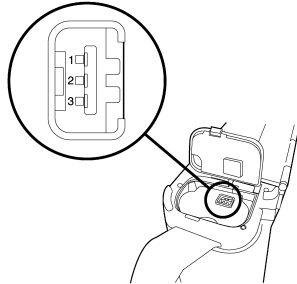

1. +12 V
2. GND
3. GND

Camera with built-in IR lens f=18 mm (25°)

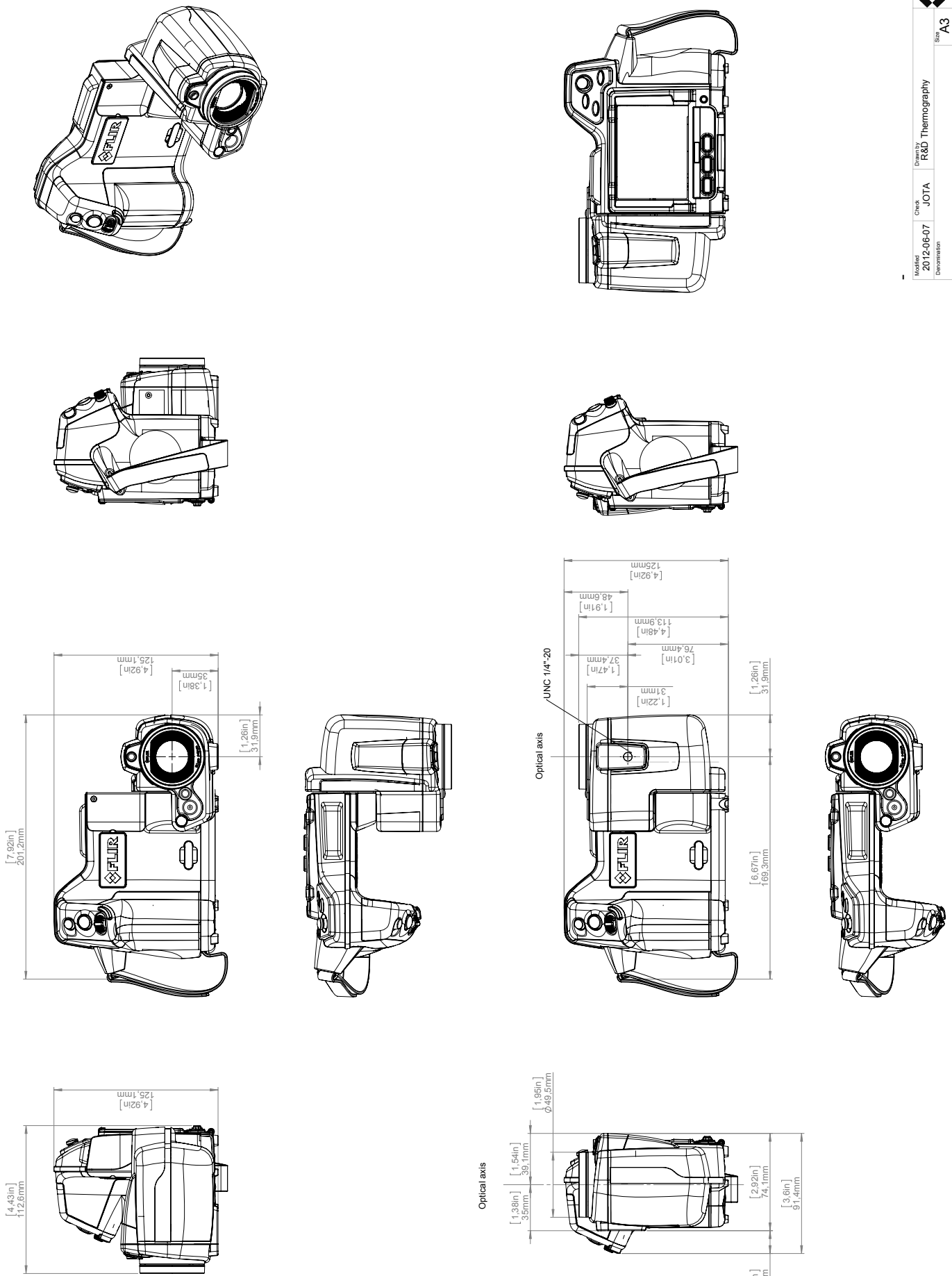

©2012 FLIR Systems, Inc. All rights reserved worldwide. No part of this drawing may be reproduced, stored in a retrieval system, or transmitted in any form, or by any means, electronic, mechanical, photocopying, recording, or otherwise, without written permission from FLIR Systems, Inc. Specifications subject to change without further notice. Dimensional data is based on nominal values. Products may be subject to regional market considerations. License procedures may apply. Product may be subject to US Export Regulations. Please refer to exportquestions@flir.com with any questions. Diversion contrary to US law is prohibited.

Camera with Lens IR f=4 mm (90°) incl support

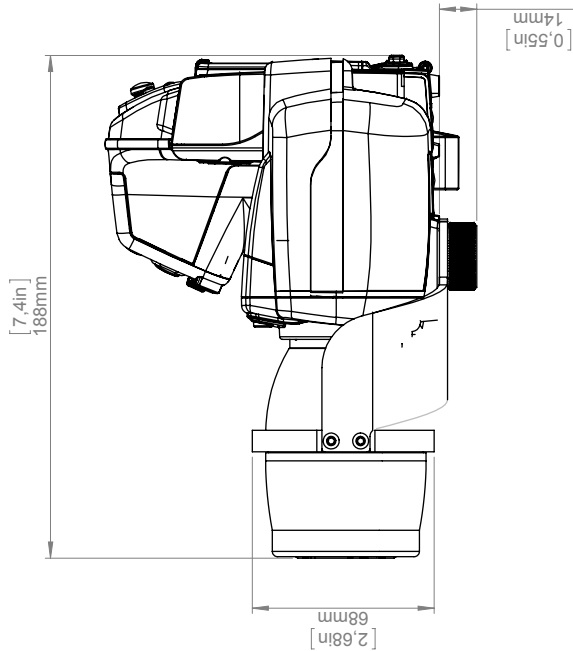
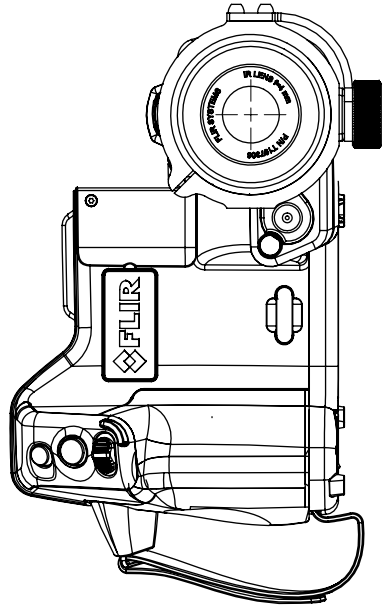
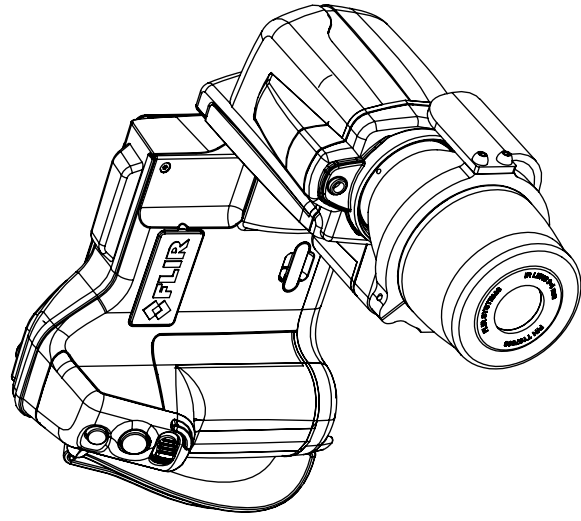

[1.62in] 41.2mm
 [2.36in] Ø 60mm

[1.38in] 35mm

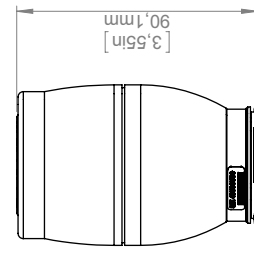
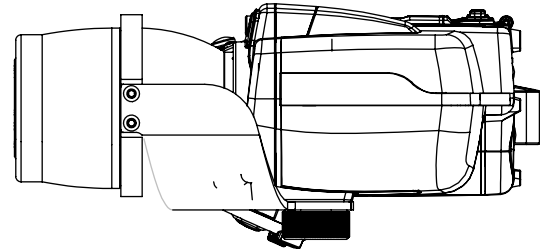

Lens support optional

[4.4in] 112.8mm
 [3.1in] 79.2mm
 [1.22in] 31mm

		Drawing No. T127604 Size A
Modified 2012-06-07 Denomination	Check JOTA	Drawn by R&D Thermography
Size A3 Scale 1:2		Sheet Z(7)
Basic Dimensions FLIR T4xx		

© 2012, FLIR Systems, Inc. All rights reserved worldwide. No part of this drawing may be reproduced, stored in a retrieval system, or transmitted in any form, or by any means, electronic, mechanical, photocopying, recording, or otherwise, without written permission from FLIR Systems, Inc. Specifications subject to change without further notice. Dimensional data is based on nominal values. Products may be subject to regional market considerations. License procedures may apply. Product may be subject to US Export Regulations. Please refer to exportquestions@flir.com with any questions. Diversion contrary to US law is prohibited.

Camera with Lens IR f=10 mm (45°)

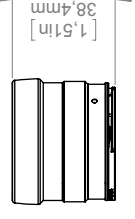
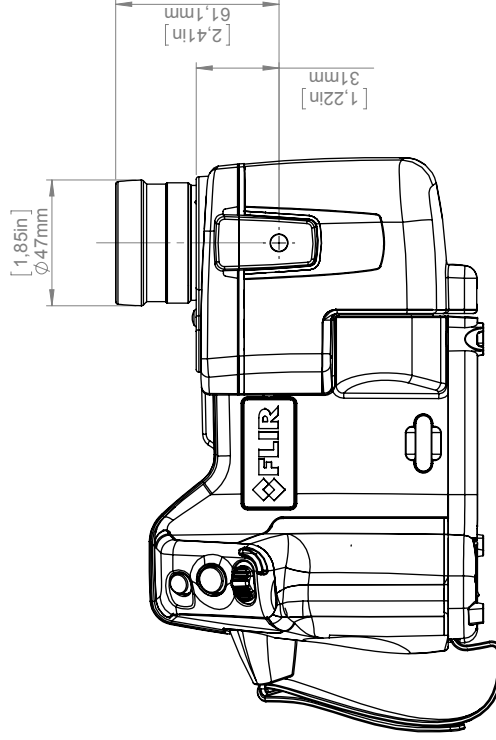
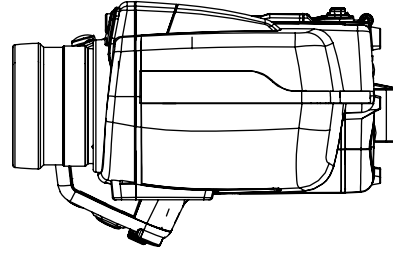
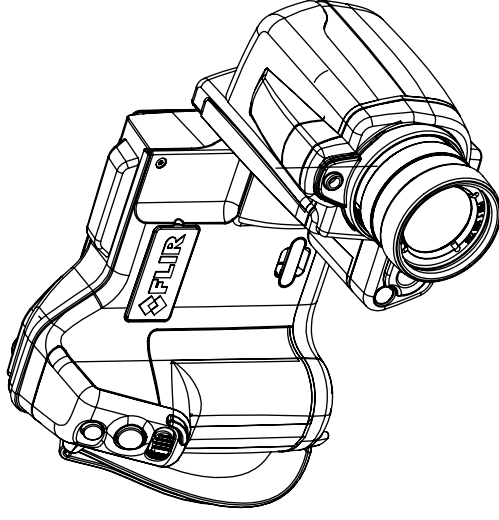
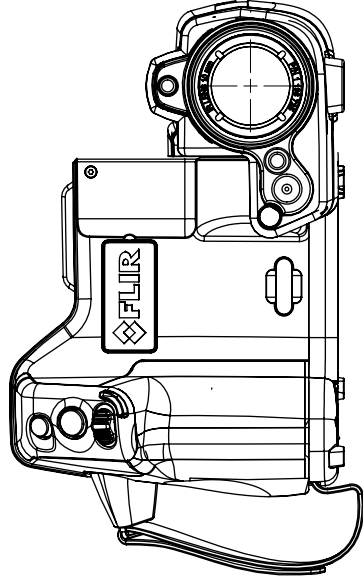
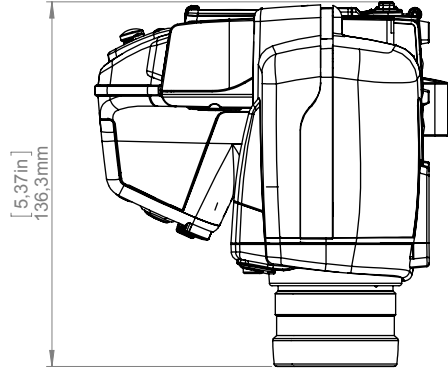

Modified 2012-06-07	Check JOTA	Drawn by R&D Thermography	FLIR
Denomination Basic Dimensions FLIR T4xx			Sheet 3(7)
Size A3			Size A
Scale 1:2			Drawing No. T127604

Camera with Lens IR f=30 mm (15°)

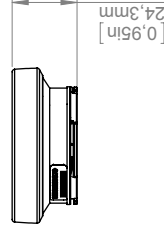
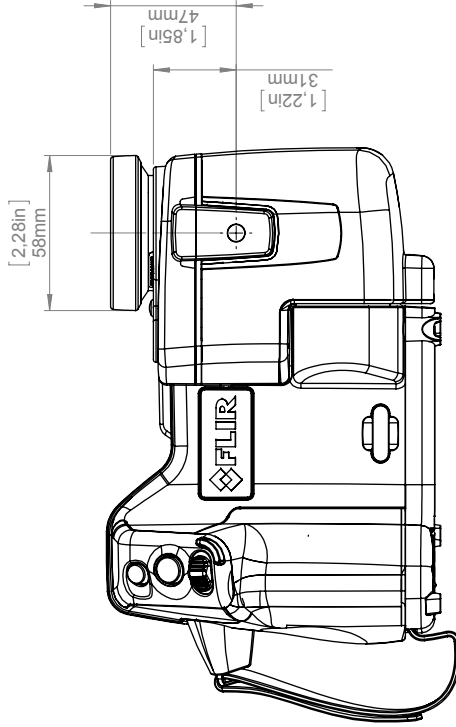
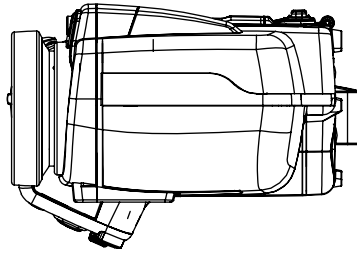
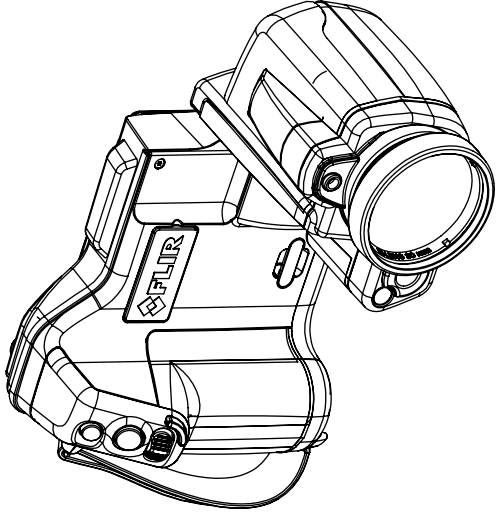
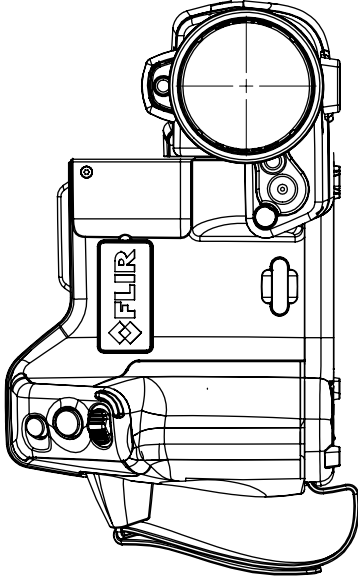
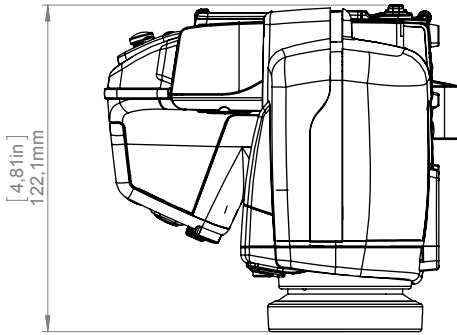

Modified 2012-06-07	Check JOTA	Drawn by R&D Thermography	FLIR
Denomination Basic Dimensions FLIR T4xx		Size A3	Sheet 4(7)
		Scale 1:2	Drawing No. T127604
			Size A

Camera with Lens IR f=76 mm (6°) incl support

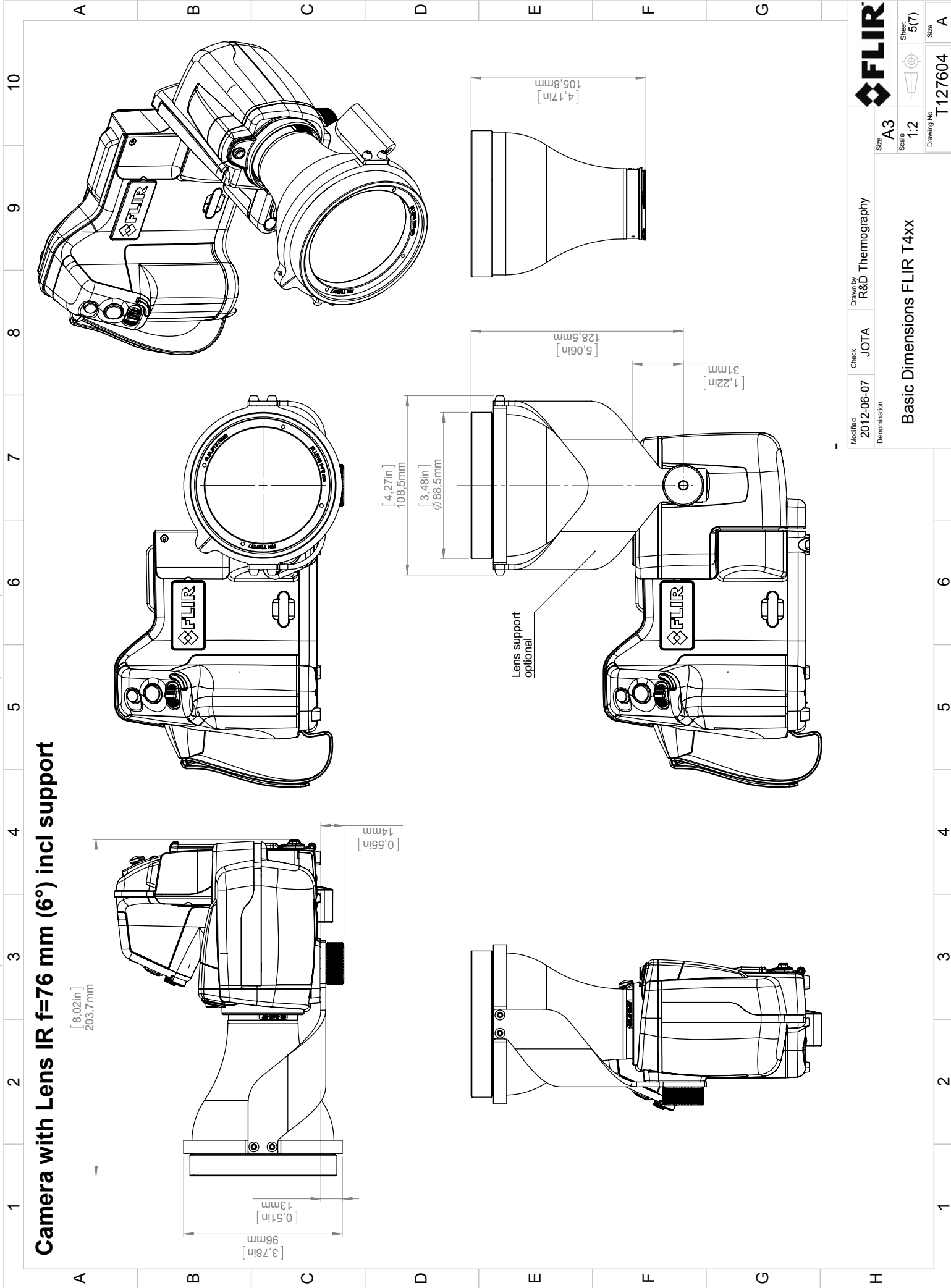

© 2012, FLIR Systems, Inc. All rights reserved worldwide. No part of this drawing may be reproduced, stored in a retrieval system, or transmitted in any form, or by any means, electronic, mechanical, photocopying, recording, or otherwise, without written permission from FLIR Systems, Inc. Specifications subject to change without further notice. Dimensional data is based on nominal values. Products may be subject to regional market considerations. License procedures may apply. Product may be subject to US Export Regulations. Please refer to exportquestions@flir.com with any questions. Diversion contrary to US law is prohibited.

Modified	2012-06-07	Check	JOTA	Drawn by	R&D Thermography	FLIR	
Denomination				Size	A3		
Basic Dimensions FLIR T4xx						Sheet	5(7)
						Scale	1:2
						Drawing No.	T127604
						Size	A

Camera with Close-up lens 2X (50 µm)

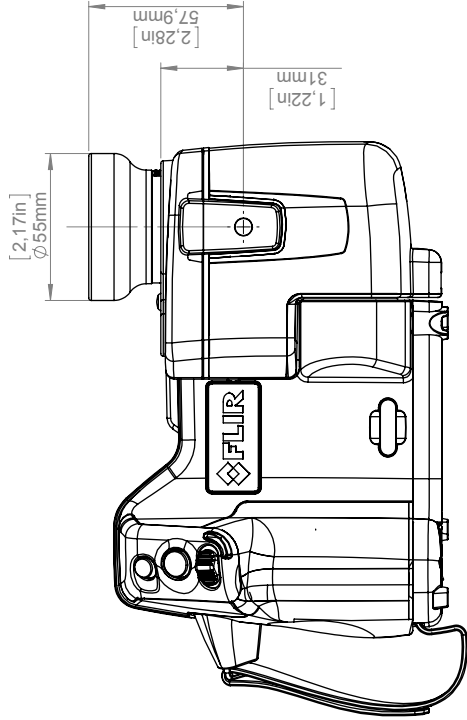
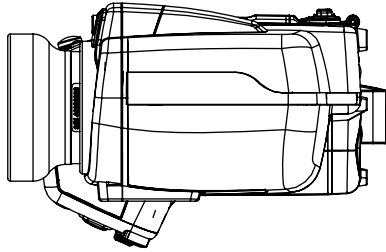
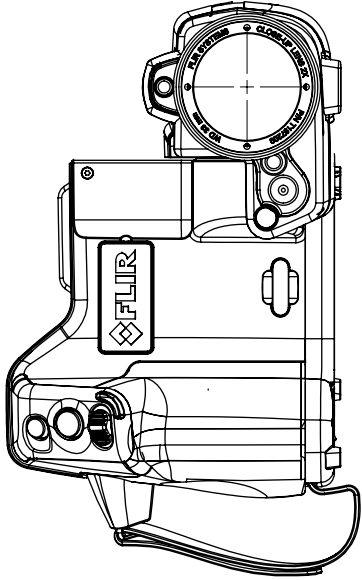
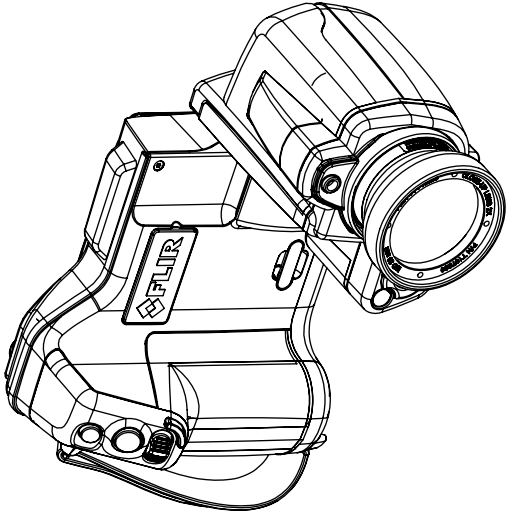
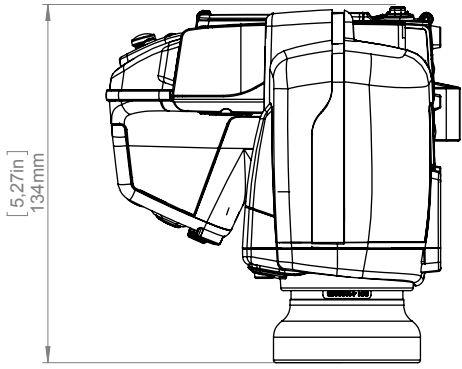

FLIR		Size	A3
Modified	2012-06-07	Check	JOTA
Drawn by		R&D Thermography	
Denomination		Scale	1:2
Drawing No.		T127604	
Sheet		6(7)	
Size		A	

Basic Dimensions FLIR T4xx

Camera with Close-up lens 4X (100 μm)

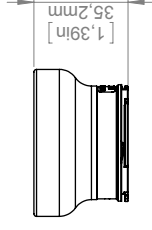
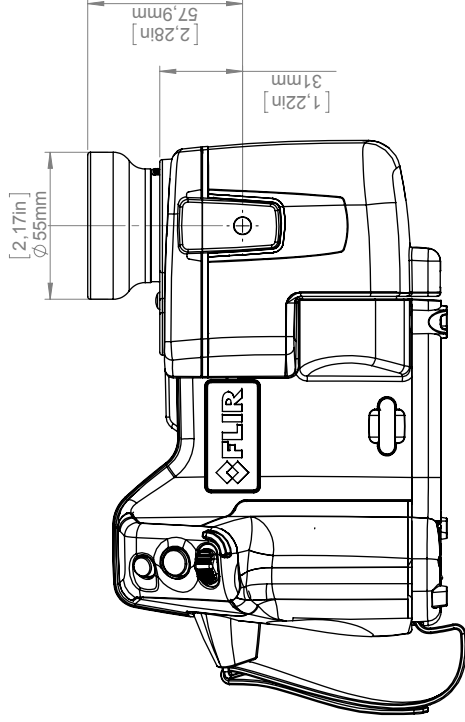
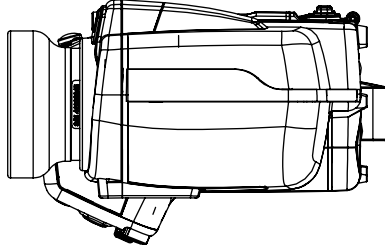
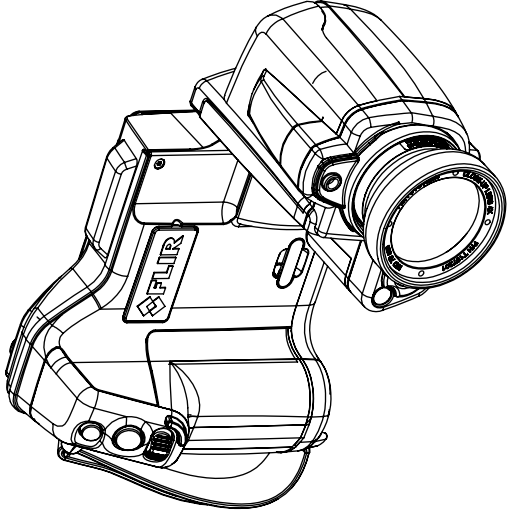
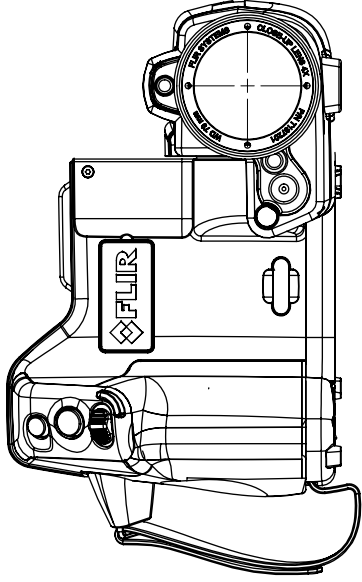
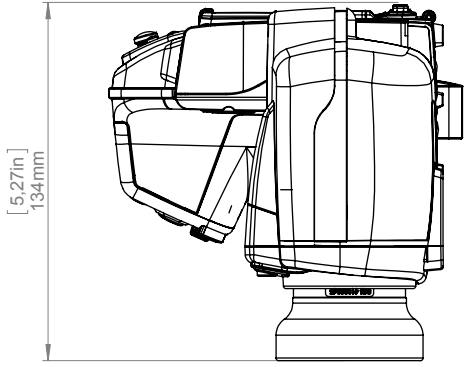

Modified 2012-06-07	Check JOTA	Drawn by R&D Thermography	FLIR
Denomination Basic Dimensions FLIR T4xx			Size A3
			Scale 1:2
			Sheet 7(7)
			Drawing No. T127604
			Size A

CE Declaration of Conformity

This is to certify that the System listed below have been designed and manufactured to meet the requirements, as applicable, of the following EU-Directives and corresponding harmonising standards. The systems consequently meet the requirements for the CE-mark.

Directives:

Directive 2004/108/EC;	Electromagnetic Compatibility
Directive 2006/95/EC;	“Low voltage Directive” (Power Supply)
Directive 1999/5/EC	“R&TTE on radio equipment and telecommunications terminal equipment”
Directive 2002/96/EC	Waste electrical and electronic equipment; WEEE (As applicable)

Standards:

Emission:	EN 61000-6-3; Electro magnetic Compatibility Generic standards - Emission
Immunity:	EN 61000-6-2; Electro magnetic Compatibility; Generic standards - Immunity
Safety (Power Supply):	EN 60950; (or other) Safety of information technology equipment
Radio	EN 301489

System: **FLIR T4XX series**

FLIR Systems AB
Quality Assurance

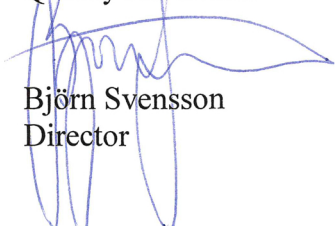

Björn Svensson
Director

28.1 Camera housing, cables, and other items

28.1.1 Liquids

Use one of these liquids:

- Warm water
- A weak detergent solution

28.1.2 Equipment

A soft cloth

28.1.3 Procedure

Follow this procedure:

1. Soak the cloth in the liquid.
2. Twist the cloth to remove excess liquid.
3. Clean the part with the cloth.



CAUTION

Do not apply solvents or similar liquids to the camera, the cables, or other items. This can cause damage.

28.2 Infrared lens

28.2.1 Liquids

Use one of these liquids:

- A commercial lens cleaning liquid with more than 30% isopropyl alcohol.
- 96% ethyl alcohol (C₂H₅OH).

28.2.2 Equipment

Cotton wool

28.2.3 Procedure

Follow this procedure:

1. Soak the cotton wool in the liquid.
2. Twist the cotton wool to remove excess liquid.
3. Clean the lens one time only and discard the cotton wool.



WARNING

Make sure that you read all applicable MSDS (Material Safety Data Sheets) and warning labels on containers before you use a liquid: the liquids can be dangerous.



CAUTION

- Be careful when you clean the infrared lens. The lens has a delicate anti-reflective coating.
- Do not clean the infrared lens too vigorously. This can damage the anti-reflective coating.

29.1 Moisture & water damage

29.1.1 General

It is often possible to detect moisture and water damage in a house by using an infrared camera. This is partly because the damaged area has a different heat conduction property and partly because it has a different thermal capacity to store heat than the surrounding material.

Many factors can come into play as to how moisture or water damage will appear in an infrared image.

For example, heating and cooling of these parts takes place at different rates depending on the material and the time of day. For this reason, it is important that other methods are used as well to check for moisture or water damage.

29.1.2 Figure

The image below shows extensive water damage on an external wall where the water has penetrated the outer facing because of an incorrectly installed window ledge.

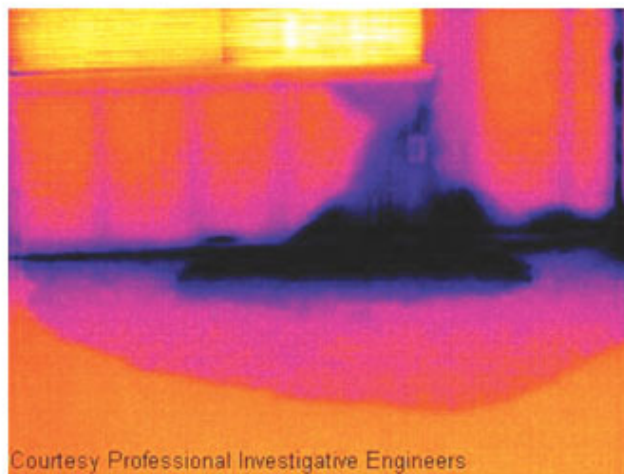

29.2 Faulty contact in socket

29.2.1 General

Depending on the type of connection a socket has, an improperly connected wire can result in local temperature increase. This temperature increase is caused by the reduced contact area between the connection point of the incoming wire and the socket, and can result in an electrical fire.

A socket's construction may differ dramatically from one manufacturer to another. For this reason, different faults in a socket can lead to the same typical appearance in an infrared image.

Local temperature increase can also result from improper contact between wire and socket, or from difference in load.

29.2.2 Figure

The image below shows a connection of a cable to a socket where improper contact in the connection has resulted in local temperature increase.

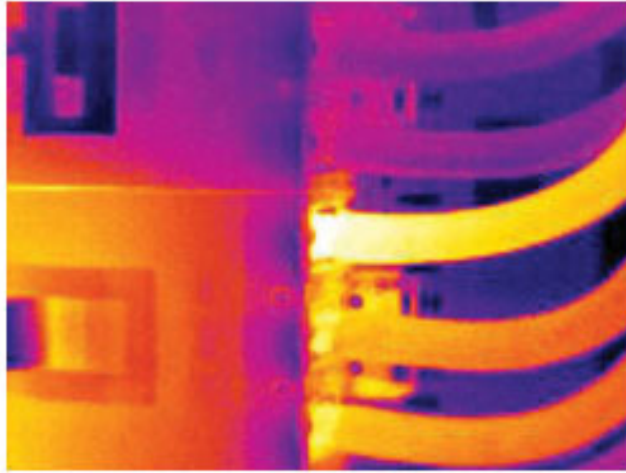

29.3 Oxidized socket

29.3.1 General

Depending on the type of socket and the environment in which the socket is installed, oxides may occur on the socket's contact surfaces. These oxides can lead to locally increased resistance when the socket is loaded, which can be seen in an infrared image as local temperature increase.

A socket's construction may differ dramatically from one manufacturer to another. For this reason, different faults in a socket can lead to the same typical appearance in an infrared image.

Local temperature increase can also result from improper contact between a wire and socket, or from difference in load.

29.3.2 Figure

The image below shows a series of fuses where one fuse has a raised temperature on the contact surfaces against the fuse holder. Because of the fuse holder's blank metal, the temperature increase is not visible there, while it is visible on the fuse's ceramic material.

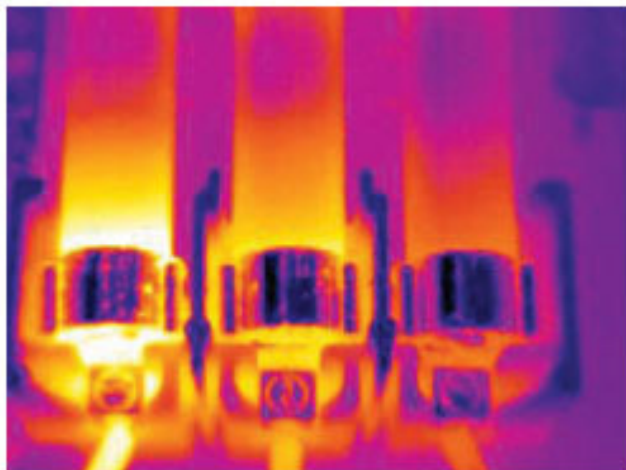

29.4 Insulation deficiencies

29.4.1 General

Insulation deficiencies may result from insulation losing volume over the course of time and thereby not entirely filling the cavity in a frame wall.

An infrared camera allows you to see these insulation deficiencies because they either have a different heat conduction property than sections with correctly installed insulation, and/or show the area where air is penetrating the frame of the building.

When you are inspecting a building, the temperature difference between the inside and outside should be at least 10°C (18°F). Studs, water pipes, concrete columns, and similar components may resemble an insulation deficiency in an infrared image. Minor differences may also occur naturally.

29.4.2 Figure

In the image below, insulation in the roof framing is lacking. Due to the absence of insulation, air has forced its way into the roof structure, which thus takes on a different characteristic appearance in the infrared image.

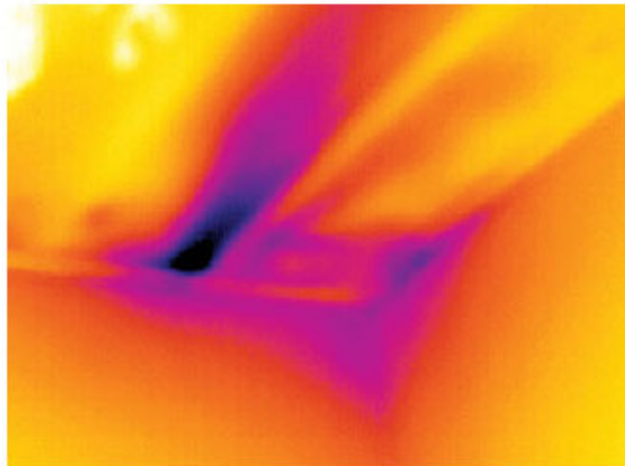

29.5 Draft

29.5.1 General

Draft can be found under baseboards, around door and window casings, and above ceiling trim. This type of draft is often possible to see with an infrared camera, as a cooler airstream cools down the surrounding surface.

When you are investigating draft in a house, there should be sub-atmospheric pressure in the house. Close all doors, windows, and ventilation ducts, and allow the kitchen fan to run for a while before you take the infrared images.

An infrared image of draft often shows a typical stream pattern. You can see this stream pattern clearly in the picture below.

Also keep in mind that drafts can be concealed by heat from floor heating circuits.

29.5.2 Figure

The image below shows a ceiling hatch where faulty installation has resulted in a strong draft.

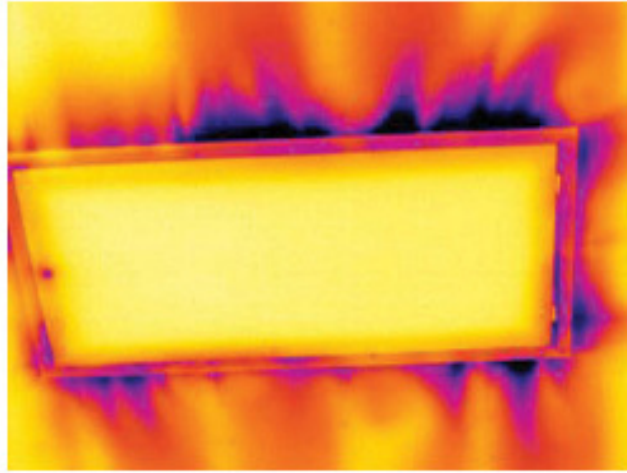

FLIR Systems was established in 1978 to pioneer the development of high-performance infrared imaging systems, and is the world leader in the design, manufacture, and marketing of thermal imaging systems for a wide variety of commercial, industrial, and government applications. Today, FLIR Systems embraces five major companies with outstanding achievements in infrared technology since 1958—the Swedish AGEMA Infrared Systems (formerly AGA Infrared Systems), the three United States companies Indigo Systems, FSI, and Inframetrics, and the French company Cedic.

Since 2007, FLIR Systems has acquired several companies with world-leading expertise in sensor technologies:

- Extech Instruments (2007)
- Ifara Tecnologías (2008)
- Salvador Imaging (2009)
- OmniTech Partners (2009)
- Directed Perception (2009)
- Raymarine (2010)
- ICx Technologies (2010)
- TackTick Marine Digital Instruments (2011)
- Aerius Photonics (2011)
- Lorex Technology (2012)
- Traficon (2012)
- MARSS (2013)
- DigitalOptics micro-optics business (2013)
- DVTEL (2015)

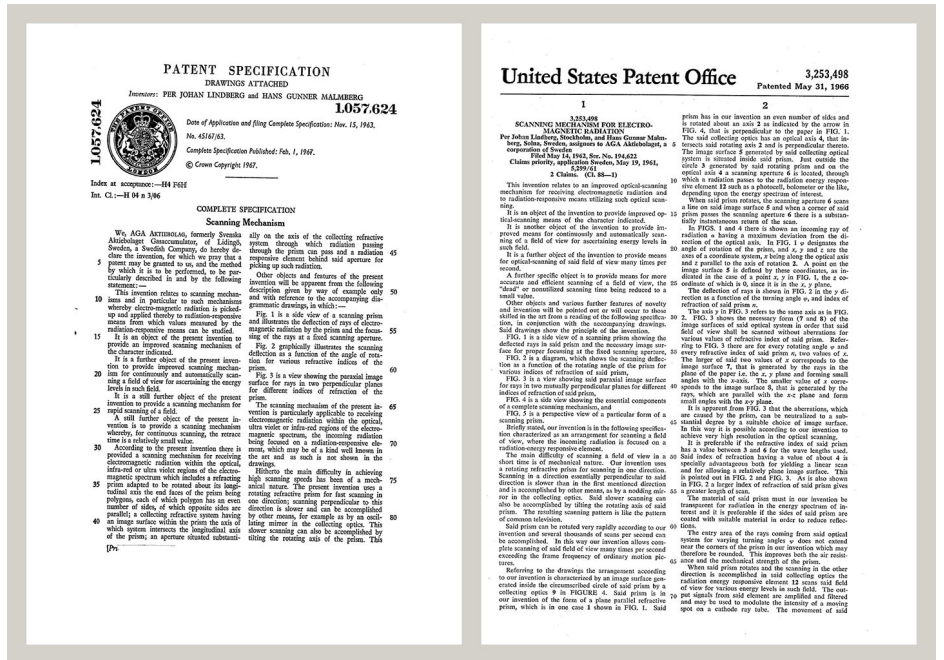

Figure 30.1 Patent documents from the early 1960s

FLIR Systems has three manufacturing plants in the United States (Portland, OR, Boston, MA, Santa Barbara, CA) and one in Sweden (Stockholm). Since 2007 there is also a manufacturing plant in Tallinn, Estonia. Direct sales offices in Belgium, Brazil, China, France, Germany, Great Britain, Hong Kong, Italy, Japan, Korea, Sweden, and the USA—together with a worldwide network of agents and distributors—support our international customer base.

FLIR Systems is at the forefront of innovation in the infrared camera industry. We anticipate market demand by constantly improving our existing cameras and developing new

ones. The company has set milestones in product design and development such as the introduction of the first battery-operated portable camera for industrial inspections, and the first uncooled infrared camera, to mention just two innovations.



Figure 30.2 1969: ThermoVision Model 661. The camera weighed approximately 25 kg (55 lb.), the oscilloscope 20 kg (44 lb.), and the tripod 15 kg (33 lb.). The operator also needed a 220 VAC generator set, and a 10 L (2.6 US gallon) jar with liquid nitrogen. To the left of the oscilloscope the Polaroid attachment (6 kg/13 lb.) can be seen.



Figure 30.3 2015: FLIR One, an accessory to iPhone and Android mobile phones. Weight: 90 g (3.2 oz.).

FLIR Systems manufactures all vital mechanical and electronic components of the camera systems itself. From detector design and manufacturing, to lenses and system electronics, to final testing and calibration, all production steps are carried out and supervised by our own engineers. The in-depth expertise of these infrared specialists ensures the accuracy and reliability of all vital components that are assembled into your infrared camera.

30.1 More than just an infrared camera

At FLIR Systems we recognize that our job is to go beyond just producing the best infrared camera systems. We are committed to enabling all users of our infrared camera systems to work more productively by providing them with the most powerful camera–software combination. Especially tailored software for predictive maintenance, R & D, and process monitoring is developed in-house. Most software is available in a wide variety of languages.

We support all our infrared cameras with a wide variety of accessories to adapt your equipment to the most demanding infrared applications.

30.2 Sharing our knowledge

Although our cameras are designed to be very user-friendly, there is a lot more to thermography than just knowing how to handle a camera. Therefore, FLIR Systems has founded the Infrared Training Center (ITC), a separate business unit, that provides certified training courses. Attending one of the ITC courses will give you a truly hands-on learning experience.

The staff of the ITC are also there to provide you with any application support you may need in putting infrared theory into practice.

30.3 Supporting our customers

FLIR Systems operates a worldwide service network to keep your camera running at all times. If you discover a problem with your camera, local service centers have all the equipment and expertise to solve it within the shortest possible time. Therefore, there is

no need to send your camera to the other side of the world or to talk to someone who does not speak your language.

absorption (absorption factor)	The amount of radiation absorbed by an object relative to the received radiation. A number between 0 and 1.
atmosphere	The gases between the object being measured and the camera, normally air.
autoadjust	A function making a camera perform an internal image correction.
autopalette	The IR image is shown with an uneven spread of colors, displaying cold objects as well as hot ones at the same time.
blackbody	Totally non-reflective object. All its radiation is due to its own temperature.
blackbody radiator	An IR radiating equipment with blackbody properties used to calibrate IR cameras.
calculated atmospheric transmission	A transmission value computed from the temperature, the relative humidity of air and the distance to the object.
cavity radiator	A bottle shaped radiator with an absorbing inside, viewed through the bottleneck.
color temperature	The temperature for which the color of a blackbody matches a specific color.
conduction	The process that makes heat diffuse into a material.
continuous adjust	A function that adjusts the image. The function works all the time, continuously adjusting brightness and contrast according to the image content.
convection	Convection is a heat transfer mode where a fluid is brought into motion, either by gravity or another force, thereby transferring heat from one place to another.
dual isotherm	An isotherm with two color bands, instead of one.
emissivity (emissivity factor)	The amount of radiation coming from an object, compared to that of a blackbody. A number between 0 and 1.
emittance	Amount of energy emitted from an object per unit of time and area (W/m^2)
environment	Objects and gases that emit radiation towards the object being measured.
estimated atmospheric transmission	A transmission value, supplied by a user, replacing a calculated one
external optics	Extra lenses, filters, heat shields etc. that can be put between the camera and the object being measured.
filter	A material transparent only to some of the infrared wavelengths.
FOV	Field of view: The horizontal angle that can be viewed through an IR lens.
FPA	Focal plane array: A type of IR detector.
graybody	An object that emits a fixed fraction of the amount of energy of a blackbody for each wavelength.
IFOV	Instantaneous field of view: A measure of the geometrical resolution of an IR camera.

image correction (internal or external)	A way of compensating for sensitivity differences in various parts of live images and also of stabilizing the camera.
infrared	Non-visible radiation, having a wavelength from about 2–13 μm .
IR	infrared
isotherm	A function highlighting those parts of an image that fall above, below or between one or more temperature intervals.
isothermal cavity	A bottle-shaped radiator with a uniform temperature viewed through the bottleneck.
Laser LocatIR	An electrically powered light source on the camera that emits laser radiation in a thin, concentrated beam to point at certain parts of the object in front of the camera.
laser pointer	An electrically powered light source on the camera that emits laser radiation in a thin, concentrated beam to point at certain parts of the object in front of the camera.
level	The center value of the temperature scale, usually expressed as a signal value.
manual adjust	A way to adjust the image by manually changing certain parameters.
NETD	Noise equivalent temperature difference. A measure of the image noise level of an IR camera.
noise	Undesired small disturbance in the infrared image
object parameters	A set of values describing the circumstances under which the measurement of an object was made, and the object itself (such as emissivity, reflected apparent temperature, distance etc.)
object signal	A non-calibrated value related to the amount of radiation received by the camera from the object.
palette	The set of colors used to display an IR image.
pixel	Stands for <i>picture element</i> . One single spot in an image.
radiance	Amount of energy emitted from an object per unit of time, area and angle ($\text{W}/\text{m}^2/\text{sr}$)
radiant power	Amount of energy emitted from an object per unit of time (W)
radiation	The process by which electromagnetic energy, is emitted by an object or a gas.
radiator	A piece of IR radiating equipment.
range	The current overall temperature measurement limitation of an IR camera. Cameras can have several ranges. Expressed as two blackbody temperatures that limit the current calibration.
reference temperature	A temperature which the ordinary measured values can be compared with.
reflection	The amount of radiation reflected by an object relative to the received radiation. A number between 0 and 1.
relative humidity	Relative humidity represents the ratio between the current water vapour mass in the air and the maximum it may contain in saturation conditions.
saturation color	The areas that contain temperatures outside the present level/span settings are colored with the saturation colors. The saturation colors contain an 'overflow' color and an 'underflow' color. There is also a third red saturation color that marks everything saturated by the detector indicating that the range should probably be changed.

span	The interval of the temperature scale, usually expressed as a signal value.
spectral (radiant) emittance	Amount of energy emitted from an object per unit of time, area and wavelength ($W/m^2/\mu m$)
temperature difference, or difference of temperature.	A value which is the result of a subtraction between two temperature values.
temperature range	The current overall temperature measurement limitation of an IR camera. Cameras can have several ranges. Expressed as two blackbody temperatures that limit the current calibration.
temperature scale	The way in which an IR image currently is displayed. Expressed as two temperature values limiting the colors.
thermogram	infrared image
transmission (or transmittance) factor	Gases and materials can be more or less transparent. Transmission is the amount of IR radiation passing through them. A number between 0 and 1.
transparent isotherm	An isotherm showing a linear spread of colors, instead of covering the highlighted parts of the image.
visual	Refers to the video mode of a IR camera, as opposed to the normal, thermographic mode. When a camera is in video mode it captures ordinary video images, while thermographic images are captured when the camera is in IR mode.

32.1 Introduction

An infrared camera measures and images the emitted infrared radiation from an object. The fact that radiation is a function of object surface temperature makes it possible for the camera to calculate and display this temperature.

However, the radiation measured by the camera does not only depend on the temperature of the object but is also a function of the emissivity. Radiation also originates from the surroundings and is reflected in the object. The radiation from the object and the reflected radiation will also be influenced by the absorption of the atmosphere.

To measure temperature accurately, it is therefore necessary to compensate for the effects of a number of different radiation sources. This is done on-line automatically by the camera. The following object parameters must, however, be supplied for the camera:

- The emissivity of the object
- The reflected apparent temperature
- The distance between the object and the camera
- The relative humidity
- Temperature of the atmosphere

32.2 Emissivity

The most important object parameter to set correctly is the emissivity which, in short, is a measure of how much radiation is emitted from the object, compared to that from a perfect blackbody of the same temperature.

Normally, object materials and surface treatments exhibit emissivity ranging from approximately 0.1 to 0.95. A highly polished (mirror) surface falls below 0.1, while an oxidized or painted surface has a higher emissivity. Oil-based paint, regardless of color in the visible spectrum, has an emissivity over 0.9 in the infrared. Human skin exhibits an emissivity 0.97 to 0.98.

Non-oxidized metals represent an extreme case of perfect opacity and high reflexivity, which does not vary greatly with wavelength. Consequently, the emissivity of metals is low – only increasing with temperature. For non-metals, emissivity tends to be high, and decreases with temperature.

32.2.1 Finding the emissivity of a sample

32.2.1.1 Step 1: Determining reflected apparent temperature

Use one of the following two methods to determine reflected apparent temperature:

32.2.1.1.1 Method 1: Direct method

Follow this procedure:

1. Look for possible reflection sources, considering that the incident angle = reflection angle ($a = b$).

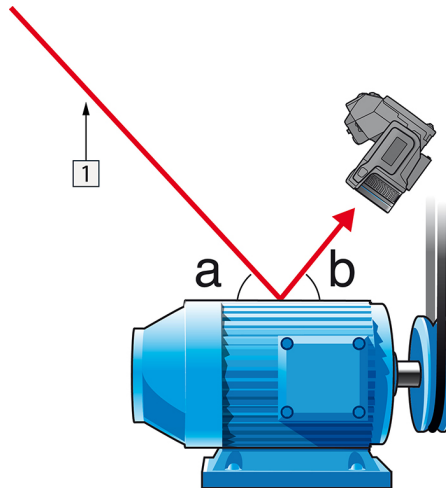

Figure 32.1 1 = Reflection source

2. If the reflection source is a spot source, modify the source by obstructing it using a piece of cardboard.

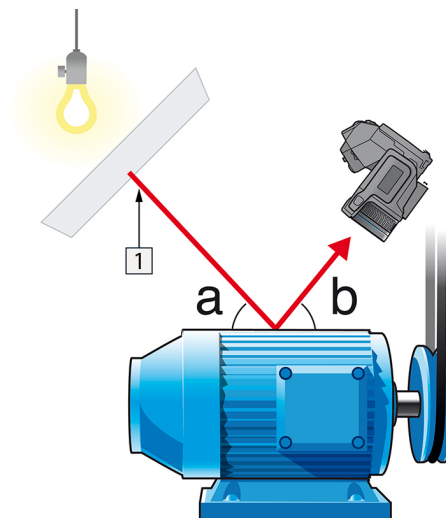

Figure 32.2 1 = Reflection source

3. Measure the radiation intensity (= apparent temperature) from the reflecting source using the following settings:

- Emissivity: 1.0
- D_{obj} : 0

You can measure the radiation intensity using one of the following two methods:

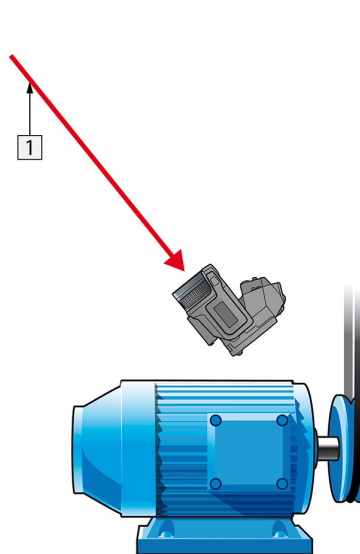

Figure 32.3 1 = Reflection source

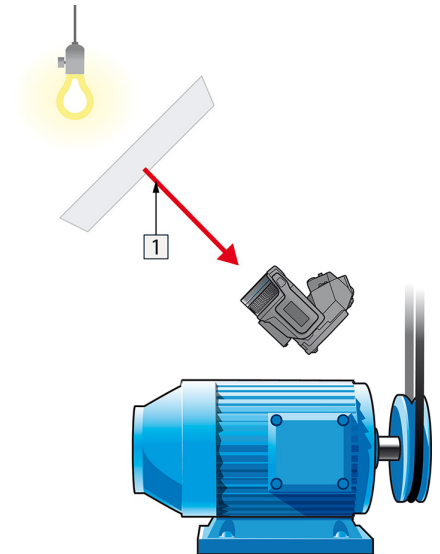

Figure 32.4 1 = Reflection source

Using a thermocouple to measure reflected apparent temperature is not recommended for two important reasons:

- A thermocouple does not measure radiation intensity
- A thermocouple requires a very good thermal contact to the surface, usually by gluing and covering the sensor by a thermal isolator.

32.2.1.1.2 Method 2: Reflector method

Follow this procedure:

1. Crumble up a large piece of aluminum foil.
2. Uncrumble the aluminum foil and attach it to a piece of cardboard of the same size.
3. Put the piece of cardboard in front of the object you want to measure. Make sure that the side with aluminum foil points to the camera.
4. Set the emissivity to 1.0.

5. Measure the apparent temperature of the aluminum foil and write it down.

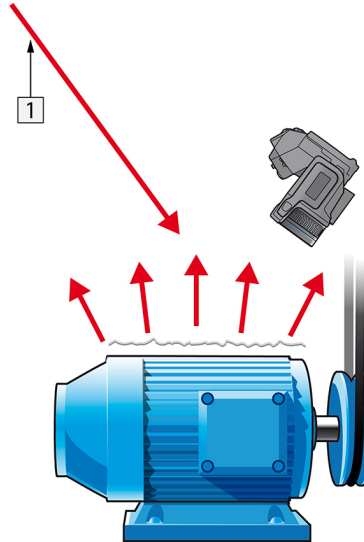

Figure 32.5 Measuring the apparent temperature of the aluminum foil.

32.2.1.2 Step 2: Determining the emissivity

Follow this procedure:

1. Select a place to put the sample.
2. Determine and set reflected apparent temperature according to the previous procedure.
3. Put a piece of electrical tape with known high emissivity on the sample.
4. Heat the sample at least 20 K above room temperature. Heating must be reasonably even.
5. Focus and auto-adjust the camera, and freeze the image.
6. Adjust *Level* and *Span* for best image brightness and contrast.
7. Set emissivity to that of the tape (usually 0.97).
8. Measure the temperature of the tape using one of the following measurement functions:
 - *Isotherm* (helps you to determine both the temperature and how evenly you have heated the sample)
 - *Spot* (simpler)
 - *Box Avg* (good for surfaces with varying emissivity).
9. Write down the temperature.
10. Move your measurement function to the sample surface.
11. Change the emissivity setting until you read the same temperature as your previous measurement.
12. Write down the emissivity.

Note

- Avoid forced convection
- Look for a thermally stable surrounding that will not generate spot reflections
- Use high quality tape that you know is not transparent, and has a high emissivity you are certain of
- This method assumes that the temperature of your tape and the sample surface are the same. If they are not, your emissivity measurement will be wrong.

32.3 Reflected apparent temperature

This parameter is used to compensate for the radiation reflected in the object. If the emissivity is low and the object temperature relatively far from that of the reflected it will be important to set and compensate for the reflected apparent temperature correctly.

32.4 Distance

The distance is the distance between the object and the front lens of the camera. This parameter is used to compensate for the following two facts:

- That radiation from the target is absorbed by the atmosphere between the object and the camera.
- That radiation from the atmosphere itself is detected by the camera.

32.5 Relative humidity

The camera can also compensate for the fact that the transmittance is also dependent on the relative humidity of the atmosphere. To do this set the relative humidity to the correct value. For short distances and normal humidity the relative humidity can normally be left at a default value of 50%.

32.6 Other parameters

In addition, some cameras and analysis programs from FLIR Systems allow you to compensate for the following parameters:

- Atmospheric temperature – *i.e.* the temperature of the atmosphere between the camera and the target
- External optics temperature – *i.e.* the temperature of any external lenses or windows used in front of the camera
- External optics transmittance – *i.e.* the transmission of any external lenses or windows used in front of the camera

Before the year 1800, the existence of the infrared portion of the electromagnetic spectrum wasn't even suspected. The original significance of the infrared spectrum, or simply 'the infrared' as it is often called, as a form of heat radiation is perhaps less obvious today than it was at the time of its discovery by Herschel in 1800.

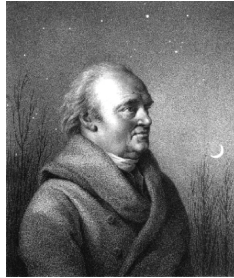

Figure 33.1 Sir William Herschel (1738–1822)

The discovery was made accidentally during the search for a new optical material. Sir William Herschel – Royal Astronomer to King George III of England, and already famous for his discovery of the planet Uranus – was searching for an optical filter material to reduce the brightness of the sun's image in telescopes during solar observations. While testing different samples of colored glass which gave similar reductions in brightness he was intrigued to find that some of the samples passed very little of the sun's heat, while others passed so much heat that he risked eye damage after only a few seconds' observation.

Herschel was soon convinced of the necessity of setting up a systematic experiment, with the objective of finding a single material that would give the desired reduction in brightness as well as the maximum reduction in heat. He began the experiment by actually repeating Newton's prism experiment, but looking for the heating effect rather than the visual distribution of intensity in the spectrum. He first blackened the bulb of a sensitive mercury-in-glass thermometer with ink, and with this as his radiation detector he proceeded to test the heating effect of the various colors of the spectrum formed on the top of a table by passing sunlight through a glass prism. Other thermometers, placed outside the sun's rays, served as controls.

As the blackened thermometer was moved slowly along the colors of the spectrum, the temperature readings showed a steady increase from the violet end to the red end. This was not entirely unexpected, since the Italian researcher, Landriani, in a similar experiment in 1777 had observed much the same effect. It was Herschel, however, who was the first to recognize that there must be a point where the heating effect reaches a maximum, and that measurements confined to the visible portion of the spectrum failed to locate this point.



Figure 33.2 Marsilio Landriani (1746–1815)

Moving the thermometer into the dark region beyond the red end of the spectrum, Herschel confirmed that the heating continued to increase. The maximum point, when he found it, lay well beyond the red end – in what is known today as the 'infrared wavelengths'.

When Herschel revealed his discovery, he referred to this new portion of the electromagnetic spectrum as the 'thermometrical spectrum'. The radiation itself he sometimes referred to as 'dark heat', or simply 'the invisible rays'. Ironically, and contrary to popular opinion, it wasn't Herschel who originated the term 'infrared'. The word only began to appear in print around 75 years later, and it is still unclear who should receive credit as the originator.

Herschel's use of glass in the prism of his original experiment led to some early controversies with his contemporaries about the actual existence of the infrared wavelengths. Different investigators, in attempting to confirm his work, used various types of glass indiscriminately, having different transparencies in the infrared. Through his later experiments, Herschel was aware of the limited transparency of glass to the newly-discovered thermal radiation, and he was forced to conclude that optics for the infrared would probably be doomed to the use of reflective elements exclusively (i.e. plane and curved mirrors). Fortunately, this proved to be true only until 1830, when the Italian investigator, Melloni, made his great discovery that naturally occurring rock salt (NaCl) – which was available in large enough natural crystals to be made into lenses and prisms – is remarkably transparent to the infrared. The result was that rock salt became the principal infrared optical material, and remained so for the next hundred years, until the art of synthetic crystal growing was mastered in the 1930's.



Figure 33.3 Macedonio Melloni (1798–1854)

Thermometers, as radiation detectors, remained unchallenged until 1829, the year Nobili invented the thermocouple. (Herschel's own thermometer could be read to $0.2\text{ }^{\circ}\text{C}$ ($0.036\text{ }^{\circ}\text{F}$), and later models were able to be read to $0.05\text{ }^{\circ}\text{C}$ ($0.09\text{ }^{\circ}\text{F}$)). Then a breakthrough occurred; Melloni connected a number of thermocouples in series to form the first thermopile. The new device was at least 40 times as sensitive as the best thermometer of the day for detecting heat radiation – capable of detecting the heat from a person standing three meters away.

The first so-called 'heat-picture' became possible in 1840, the result of work by Sir John Herschel, son of the discoverer of the infrared and a famous astronomer in his own right. Based upon the differential evaporation of a thin film of oil when exposed to a heat pattern focused upon it, the thermal image could be seen by reflected light where the interference effects of the oil film made the image visible to the eye. Sir John also managed to obtain a primitive record of the thermal image on paper, which he called a 'thermograph'.



Figure 33.4 Samuel P. Langley (1834–1906)

The improvement of infrared-detector sensitivity progressed slowly. Another major breakthrough, made by Langley in 1880, was the invention of the bolometer. This consisted of a thin blackened strip of platinum connected in one arm of a Wheatstone bridge circuit upon which the infrared radiation was focused and to which a sensitive galvanometer responded. This instrument is said to have been able to detect the heat from a cow at a distance of 400 meters.

An English scientist, Sir James Dewar, first introduced the use of liquefied gases as cooling agents (such as liquid nitrogen with a temperature of $-196\text{ }^{\circ}\text{C}$ ($-320.8\text{ }^{\circ}\text{F}$)) in low temperature research. In 1892 he invented a unique vacuum insulating container in which it is possible to store liquefied gases for entire days. The common 'thermos bottle', used for storing hot and cold drinks, is based upon his invention.

Between the years 1900 and 1920, the inventors of the world 'discovered' the infrared. Many patents were issued for devices to detect personnel, artillery, aircraft, ships – and even icebergs. The first operating systems, in the modern sense, began to be developed during the 1914–18 war, when both sides had research programs devoted to the military exploitation of the infrared. These programs included experimental systems for enemy intrusion/detection, remote temperature sensing, secure communications, and 'flying torpedo' guidance. An infrared search system tested during this period was able to detect an approaching airplane at a distance of 1.5 km (0.94 miles), or a person more than 300 meters (984 ft.) away.

The most sensitive systems up to this time were all based upon variations of the bolometer idea, but the period between the two wars saw the development of two revolutionary new infrared detectors: the image converter and the photon detector. At first, the image converter received the greatest attention by the military, because it enabled an observer for the first time in history to literally 'see in the dark'. However, the sensitivity of the image converter was limited to the near infrared wavelengths, and the most interesting military targets (i.e. enemy soldiers) had to be illuminated by infrared search beams. Since this involved the risk of giving away the observer's position to a similarly-equipped enemy observer, it is understandable that military interest in the image converter eventually faded.

The tactical military disadvantages of so-called 'active' (i.e. search beam-equipped) thermal imaging systems provided impetus following the 1939–45 war for extensive secret military infrared-research programs into the possibilities of developing 'passive' (no search beam) systems around the extremely sensitive photon detector. During this period, military secrecy regulations completely prevented disclosure of the status of infrared-imaging technology. This secrecy only began to be lifted in the middle of the 1950's, and from that time adequate thermal-imaging devices finally began to be available to civilian science and industry.

34.1 Introduction

The subjects of infrared radiation and the related technique of thermography are still new to many who will use an infrared camera. In this section the theory behind thermography will be given.

34.2 The electromagnetic spectrum

The electromagnetic spectrum is divided arbitrarily into a number of wavelength regions, called *bands*, distinguished by the methods used to produce and detect the radiation. There is no fundamental difference between radiation in the different bands of the electromagnetic spectrum. They are all governed by the same laws and the only differences are those due to differences in wavelength.

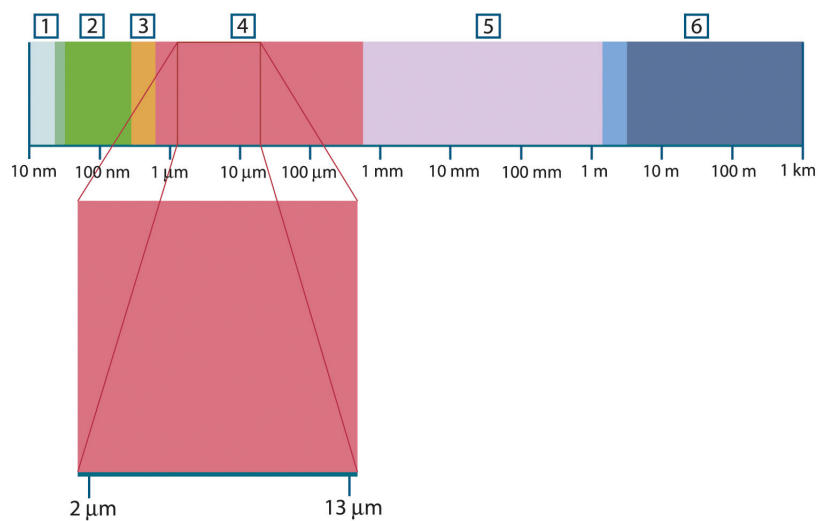

Figure 34.1 The electromagnetic spectrum. 1: X-ray; 2: UV; 3: Visible; 4: IR; 5: Microwaves; 6: Radiowaves.

Thermography makes use of the infrared spectral band. At the short-wavelength end the boundary lies at the limit of visual perception, in the deep red. At the long-wavelength end it merges with the microwave radio wavelengths, in the millimeter range.

The infrared band is often further subdivided into four smaller bands, the boundaries of which are also arbitrarily chosen. They include: the *near infrared* (0.75–3 μm), the *middle infrared* (3–6 μm), the *far infrared* (6–15 μm) and the *extreme infrared* (15–100 μm). Although the wavelengths are given in μm (micrometers), other units are often still used to measure wavelength in this spectral region, e.g. nanometer (nm) and Ångström (Å).

The relationships between the different wavelength measurements is:

$$10\,000 \text{ \AA} = 1\,000 \text{ nm} = 1 \mu = 1 \mu\text{m}$$

34.3 Blackbody radiation

A blackbody is defined as an object which absorbs all radiation that impinges on it at any wavelength. The apparent misnomer *black* relating to an object emitting radiation is explained by Kirchhoff's Law (after *Gustav Robert Kirchhoff*, 1824–1887), which states that a body capable of absorbing all radiation at any wavelength is equally capable in the emission of radiation.

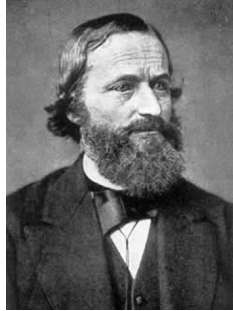

Figure 34.2 Gustav Robert Kirchhoff (1824–1887)

The construction of a blackbody source is, in principle, very simple. The radiation characteristics of an aperture in an isotherm cavity made of an opaque absorbing material represents almost exactly the properties of a blackbody. A practical application of the principle to the construction of a perfect absorber of radiation consists of a box that is light tight except for an aperture in one of the sides. Any radiation which then enters the hole is scattered and absorbed by repeated reflections so only an infinitesimal fraction can possibly escape. The blackness which is obtained at the aperture is nearly equal to a blackbody and almost perfect for all wavelengths.

By providing such an isothermal cavity with a suitable heater it becomes what is termed a *cavity radiator*. An isothermal cavity heated to a uniform temperature generates blackbody radiation, the characteristics of which are determined solely by the temperature of the cavity. Such cavity radiators are commonly used as sources of radiation in temperature reference standards in the laboratory for calibrating thermographic instruments, such as a FLIR Systems camera for example.

If the temperature of blackbody radiation increases to more than 525°C (977°F), the source begins to be visible so that it appears to the eye no longer black. This is the incipient red heat temperature of the radiator, which then becomes orange or yellow as the temperature increases further. In fact, the definition of the so-called *color temperature* of an object is the temperature to which a blackbody would have to be heated to have the same appearance.

Now consider three expressions that describe the radiation emitted from a blackbody.

34.3.1 Planck's law



Figure 34.3 Max Planck (1858–1947)

Max Planck (1858–1947) was able to describe the spectral distribution of the radiation from a blackbody by means of the following formula:

$$W_{\lambda b} = \frac{2\pi hc^2}{\lambda^5 \left(e^{\frac{hc}{\lambda kT}} - 1 \right)} \times 10^{-6} [\text{Watt} / \text{m}^2, \mu\text{m}]$$

where:

$W_{\lambda b}$	Blackbody spectral radiant emittance at wavelength λ .
c	Velocity of light = 3×10^8 m/s
h	Planck's constant = 6.6×10^{-34} Joule sec.
k	Boltzmann's constant = 1.4×10^{-23} Joule/K.
T	Absolute temperature (K) of a blackbody.
λ	Wavelength (μm).

Note The factor 10^{-6} is used since spectral emittance in the curves is expressed in $\text{Watt/m}^2, \mu\text{m}$.

Planck's formula, when plotted graphically for various temperatures, produces a family of curves. Following any particular Planck curve, the spectral emittance is zero at $\lambda = 0$, then increases rapidly to a maximum at a wavelength λ_{max} and after passing it approaches zero again at very long wavelengths. The higher the temperature, the shorter the wavelength at which maximum occurs.

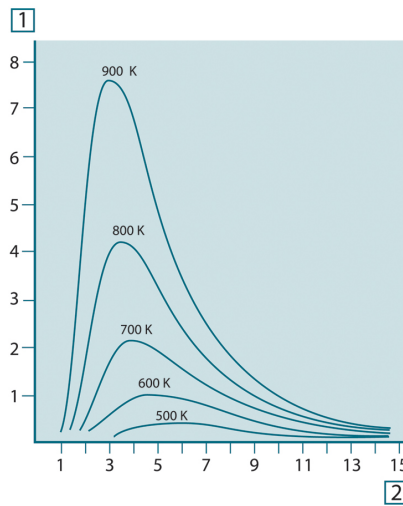

Figure 34.4 Blackbody spectral radiant emittance according to Planck's law, plotted for various absolute temperatures. 1: Spectral radiant emittance ($\text{W/cm}^2 \times 10^3(\mu\text{m})$); 2: Wavelength (μm)

34.3.2 Wien's displacement law

By differentiating Planck's formula with respect to λ , and finding the maximum, we have:

$$\lambda_{\text{max}} = \frac{2898}{T} [\mu\text{m}]$$

This is Wien's formula (after *Wilhelm Wien*, 1864–1928), which expresses mathematically the common observation that colors vary from red to orange or yellow as the temperature of a thermal radiator increases. The wavelength of the color is the same as the wavelength calculated for λ_{max} . A good approximation of the value of λ_{max} for a given blackbody temperature is obtained by applying the rule-of-thumb $3\,000/T \mu\text{m}$. Thus, a very hot star such as Sirius (11 000 K), emitting bluish-white light, radiates with the peak of spectral radiant emittance occurring within the invisible ultraviolet spectrum, at wavelength $0.27 \mu\text{m}$.

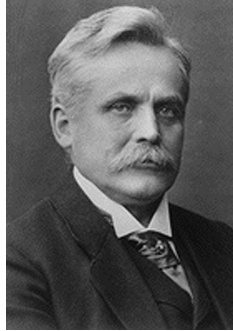

Figure 34.5 Wilhelm Wien (1864–1928)

The sun (approx. 6 000 K) emits yellow light, peaking at about 0.5 μm in the middle of the visible light spectrum.

At room temperature (300 K) the peak of radiant emittance lies at 9.7 μm , in the far infrared, while at the temperature of liquid nitrogen (77 K) the maximum of the almost insignificant amount of radiant emittance occurs at 38 μm , in the extreme infrared wavelengths.

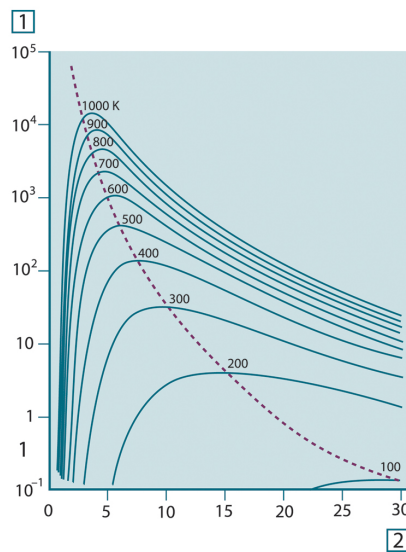

Figure 34.6 Planckian curves plotted on semi-log scales from 100 K to 1000 K. The dotted line represents the locus of maximum radiant emittance at each temperature as described by Wien's displacement law. 1: Spectral radiant emittance ($\text{W}/\text{cm}^2 (\mu\text{m})$); 2: Wavelength (μm).

34.3.3 Stefan-Boltzmann's law

By integrating Planck's formula from $\lambda = 0$ to $\lambda = \infty$, we obtain the total radiant emittance (W_b) of a blackbody:

$$W_b = \sigma T^4 \text{ [Watt}/\text{m}^2\text{]}$$

This is the Stefan-Boltzmann formula (after *Josef Stefan*, 1835–1893, and *Ludwig Boltzmann*, 1844–1906), which states that the total emissive power of a blackbody is proportional to the fourth power of its absolute temperature. Graphically, W_b represents the area below the Planck curve for a particular temperature. It can be shown that the radiant emittance in the interval $\lambda = 0$ to λ_{max} is only 25% of the total, which represents about the amount of the sun's radiation which lies inside the visible light spectrum.



Figure 34.7 Josef Stefan (1835–1893), and Ludwig Boltzmann (1844–1906)

Using the Stefan-Boltzmann formula to calculate the power radiated by the human body, at a temperature of 300 K and an external surface area of approx. 2 m², we obtain 1 kW. This power loss could not be sustained if it were not for the compensating absorption of radiation from surrounding surfaces, at room temperatures which do not vary too drastically from the temperature of the body – or, of course, the addition of clothing.

34.3.4 Non-blackbody emitters

So far, only blackbody radiators and blackbody radiation have been discussed. However, real objects almost never comply with these laws over an extended wavelength region – although they may approach the blackbody behavior in certain spectral intervals. For example, a certain type of white paint may appear perfectly *white* in the visible light spectrum, but becomes distinctly *gray* at about 2 μm, and beyond 3 μm it is almost *black*.

There are three processes which can occur that prevent a real object from acting like a blackbody: a fraction of the incident radiation α may be absorbed, a fraction ρ may be reflected, and a fraction τ may be transmitted. Since all of these factors are more or less wavelength dependent, the subscript λ is used to imply the spectral dependence of their definitions. Thus:

- The spectral absorptance α_λ = the ratio of the spectral radiant power absorbed by an object to that incident upon it.
- The spectral reflectance ρ_λ = the ratio of the spectral radiant power reflected by an object to that incident upon it.
- The spectral transmittance τ_λ = the ratio of the spectral radiant power transmitted through an object to that incident upon it.

The sum of these three factors must always add up to the whole at any wavelength, so we have the relation:

$$\alpha_\lambda + \rho_\lambda + \tau_\lambda = 1$$

For opaque materials $\tau_\lambda = 0$ and the relation simplifies to:

$$\varepsilon_\lambda + \rho_\lambda = 1$$

Another factor, called the emissivity, is required to describe the fraction ε of the radiant emittance of a blackbody produced by an object at a specific temperature. Thus, we have the definition:

The spectral emissivity ε_λ = the ratio of the spectral radiant power from an object to that from a blackbody at the same temperature and wavelength.

Expressed mathematically, this can be written as the ratio of the spectral emittance of the object to that of a blackbody as follows:

$$\varepsilon_\lambda = \frac{W_{\lambda o}}{W_{\lambda b}}$$

Generally speaking, there are three types of radiation source, distinguished by the ways in which the spectral emittance of each varies with wavelength.

- A blackbody, for which $\varepsilon_\lambda = \varepsilon = 1$
- A graybody, for which $\varepsilon_\lambda = \varepsilon = \text{constant less than 1}$

- A selective radiator, for which ε varies with wavelength

According to Kirchhoff's law, for any material the spectral emissivity and spectral absorptance of a body are equal at any specified temperature and wavelength. That is:

$$\varepsilon_\lambda = \alpha_\lambda$$

From this we obtain, for an opaque material (since $\alpha_\lambda + \rho_\lambda = 1$):

$$\varepsilon_\lambda + \rho_\lambda = 1$$

For highly polished materials ε_λ approaches zero, so that for a perfectly reflecting material (*i.e.* a perfect mirror) we have:

$$\rho_\lambda = 1$$

For a graybody radiator, the Stefan-Boltzmann formula becomes:

$$W = \varepsilon \sigma T^4 \text{ [Watt/m}^2\text{]}$$

This states that the total emissive power of a graybody is the same as a blackbody at the same temperature reduced in proportion to the value of ε from the graybody.

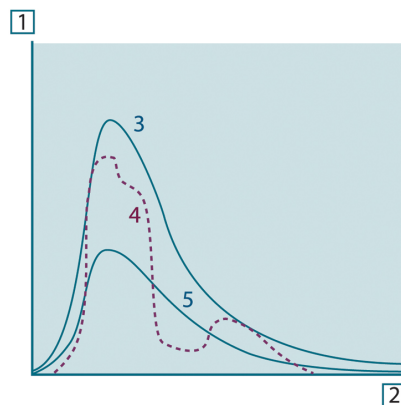

Figure 34.8 Spectral radiant emittance of three types of radiators. 1: Spectral radiant emittance; 2: Wavelength; 3: Blackbody; 4: Selective radiator; 5: Graybody.

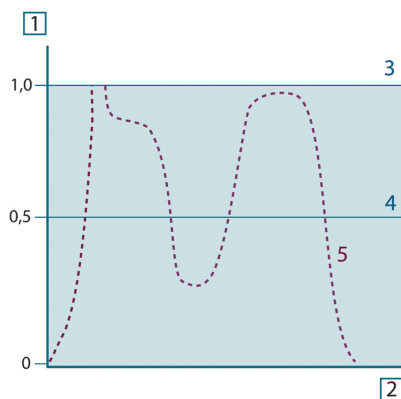

Figure 34.9 Spectral emissivity of three types of radiators. 1: Spectral emissivity; 2: Wavelength; 3: Blackbody; 4: Graybody; 5: Selective radiator.

34.4 Infrared semi-transparent materials

Consider now a non-metallic, semi-transparent body – let us say, in the form of a thick flat plate of plastic material. When the plate is heated, radiation generated within its volume must work its way toward the surfaces through the material in which it is partially absorbed. Moreover, when it arrives at the surface, some of it is reflected back into the interior. The back-reflected radiation is again partially absorbed, but some of it arrives at the other surface, through which most of it escapes; part of it is reflected back again. Although the progressive reflections become weaker and weaker they must all be added up when the total emittance of the plate is sought. When the resulting geometrical series is summed, the effective emissivity of a semi-transparent plate is obtained as:

$$\varepsilon_{\lambda} = \frac{(1 - \rho_{\lambda})(1 - \tau_{\lambda})}{1 - \rho_{\lambda}\tau_{\lambda}}$$

When the plate becomes opaque this formula is reduced to the single formula:

$$\varepsilon_{\lambda} = 1 - \rho_{\lambda}$$

This last relation is a particularly convenient one, because it is often easier to measure reflectance than to measure emissivity directly.

As already mentioned, when viewing an object, the camera receives radiation not only from the object itself. It also collects radiation from the surroundings reflected via the object surface. Both these radiation contributions become attenuated to some extent by the atmosphere in the measurement path. To this comes a third radiation contribution from the atmosphere itself.

This description of the measurement situation, as illustrated in the figure below, is so far a fairly true description of the real conditions. What has been neglected could for instance be sun light scattering in the atmosphere or stray radiation from intense radiation sources outside the field of view. Such disturbances are difficult to quantify, however, in most cases they are fortunately small enough to be neglected. In case they are not negligible, the measurement configuration is likely to be such that the risk for disturbance is obvious, at least to a trained operator. It is then his responsibility to modify the measurement situation to avoid the disturbance e.g. by changing the viewing direction, shielding off intense radiation sources etc.

Accepting the description above, we can use the figure below to derive a formula for the calculation of the object temperature from the calibrated camera output.

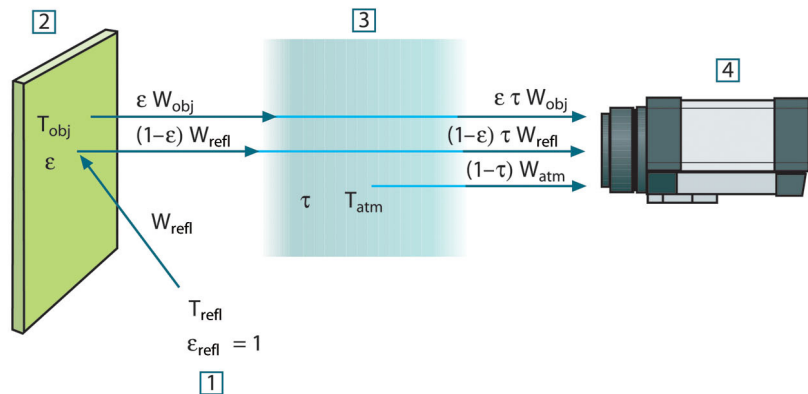

Figure 35.1 A schematic representation of the general thermographic measurement situation. 1: Surroundings; 2: Object; 3: Atmosphere; 4: Camera

Assume that the received radiation power W from a blackbody source of temperature T_{source} on short distance generates a camera output signal U_{source} that is proportional to the power input (power linear camera). We can then write (Equation 1):

$$U_{\text{source}} = CW(T_{\text{source}})$$

or, with simplified notation:

$$U_{\text{source}} = CW_{\text{source}}$$

where C is a constant.

Should the source be a graybody with emittance ϵ , the received radiation would consequently be $\epsilon W_{\text{source}}$.

We are now ready to write the three collected radiation power terms:

1. *Emission from the object* = $\epsilon \tau W_{\text{obj}}$, where ϵ is the emittance of the object and τ is the transmittance of the atmosphere. The object temperature is T_{obj} .

2. *Reflected emission from ambient sources* = $(1 - \varepsilon)\tau W_{\text{refl}}$, where $(1 - \varepsilon)$ is the reflectance of the object. The ambient sources have the temperature T_{refl} .

It has here been assumed that the temperature T_{refl} is the same for all emitting surfaces within the hemisphere seen from a point on the object surface. This is of course sometimes a simplification of the true situation. It is, however, a necessary simplification in order to derive a workable formula, and T_{refl} can – at least theoretically – be given a value that represents an efficient temperature of a complex surrounding.

Note also that we have assumed that the emittance for the surroundings = 1. This is correct in accordance with Kirchhoff's law: All radiation impinging on the surrounding surfaces will eventually be absorbed by the same surfaces. Thus the emittance = 1. (Note though that the latest discussion requires the complete sphere around the object to be considered.)

3. *Emission from the atmosphere* = $(1 - \tau)\tau W_{\text{atm}}$, where $(1 - \tau)$ is the emittance of the atmosphere. The temperature of the atmosphere is T_{atm} .

The total received radiation power can now be written (Equation 2):

$$W_{\text{tot}} = \varepsilon\tau W_{\text{obj}} + (1 - \varepsilon)\tau W_{\text{refl}} + (1 - \tau)W_{\text{atm}}$$

We multiply each term by the constant C of Equation 1 and replace the CW products by the corresponding U according to the same equation, and get (Equation 3):

$$U_{\text{tot}} = \varepsilon\tau U_{\text{obj}} + (1 - \varepsilon)\tau U_{\text{refl}} + (1 - \tau)U_{\text{atm}}$$

Solve Equation 3 for U_{obj} (Equation 4):

$$U_{\text{obj}} = \frac{1}{\varepsilon\tau} U_{\text{tot}} - \frac{1 - \varepsilon}{\varepsilon} U_{\text{refl}} - \frac{1 - \tau}{\varepsilon\tau} U_{\text{atm}}$$

This is the general measurement formula used in all the FLIR Systems thermographic equipment. The voltagages of the formula are:

Table 35.1 Voltages

U_{obj}	Calculated camera output voltage for a blackbody of temperature T_{obj} i.e. a voltage that can be directly converted into true requested object temperature.
U_{tot}	Measured camera output voltage for the actual case.
U_{refl}	Theoretical camera output voltage for a blackbody of temperature T_{refl} according to the calibration.
U_{atm}	Theoretical camera output voltage for a blackbody of temperature T_{atm} according to the calibration.

The operator has to supply a number of parameter values for the calculation:

- the object emittance ε ,
- the relative humidity,
- T_{atm}
- object distance (D_{obj})
- the (effective) temperature of the object surroundings, or the reflected ambient temperature T_{refl} , and
- the temperature of the atmosphere T_{atm}

This task could sometimes be a heavy burden for the operator since there are normally no easy ways to find accurate values of emittance and atmospheric transmittance for the actual case. The two temperatures are normally less of a problem provided the surroundings do not contain large and intense radiation sources.

A natural question in this connection is: How important is it to know the right values of these parameters? It could though be of interest to get a feeling for this problem already here by looking into some different measurement cases and compare the relative

magnitudes of the three radiation terms. This will give indications about when it is important to use correct values of which parameters.

The figures below illustrates the relative magnitudes of the three radiation contributions for three different object temperatures, two emittances, and two spectral ranges: SW and LW. Remaining parameters have the following fixed values:

- $\tau = 0.88$
- $T_{\text{refl}} = +20^{\circ}\text{C}$ ($+68^{\circ}\text{F}$)
- $T_{\text{atm}} = +20^{\circ}\text{C}$ ($+68^{\circ}\text{F}$)

It is obvious that measurement of low object temperatures are more critical than measuring high temperatures since the 'disturbing' radiation sources are relatively much stronger in the first case. Should also the object emittance be low, the situation would be still more difficult.

We have finally to answer a question about the importance of being allowed to use the calibration curve above the highest calibration point, what we call extrapolation. Imagine that we in a certain case measure $U_{\text{tot}} = 4.5$ volts. The highest calibration point for the camera was in the order of 4.1 volts, a value unknown to the operator. Thus, even if the object happened to be a blackbody, i.e. $U_{\text{obj}} = U_{\text{tot}}$, we are actually performing extrapolation of the calibration curve when converting 4.5 volts into temperature.

Let us now assume that the object is not black, it has an emittance of 0.75, and the transmittance is 0.92. We also assume that the two second terms of Equation 4 amount to 0.5 volts together. Computation of U_{obj} by means of Equation 4 then results in $U_{\text{obj}} = 4.5 / 0.75 / 0.92 - 0.5 = 6.0$. This is a rather extreme extrapolation, particularly when considering that the video amplifier might limit the output to 5 volts! Note, though, that the application of the calibration curve is a theoretical procedure where no electronic or other limitations exist. We trust that if there had been no signal limitations in the camera, and if it had been calibrated far beyond 5 volts, the resulting curve would have been very much the same as our real curve extrapolated beyond 4.1 volts, provided the calibration algorithm is based on radiation physics, like the FLIR Systems algorithm. Of course there must be a limit to such extrapolations.

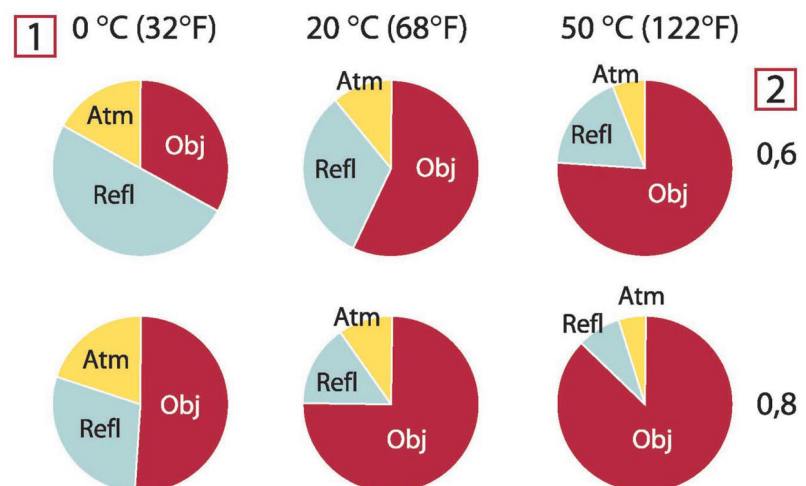

Figure 35.2 Relative magnitudes of radiation sources under varying measurement conditions (SW camera). 1: Object temperature; 2: Emittance; Obj: Object radiation; Refl: Reflected radiation; Atm: atmosphere radiation. Fixed parameters: $\tau = 0.88$; $T_{\text{refl}} = 20^{\circ}\text{C}$ ($+68^{\circ}\text{F}$); $T_{\text{atm}} = 20^{\circ}\text{C}$ ($+68^{\circ}\text{F}$).

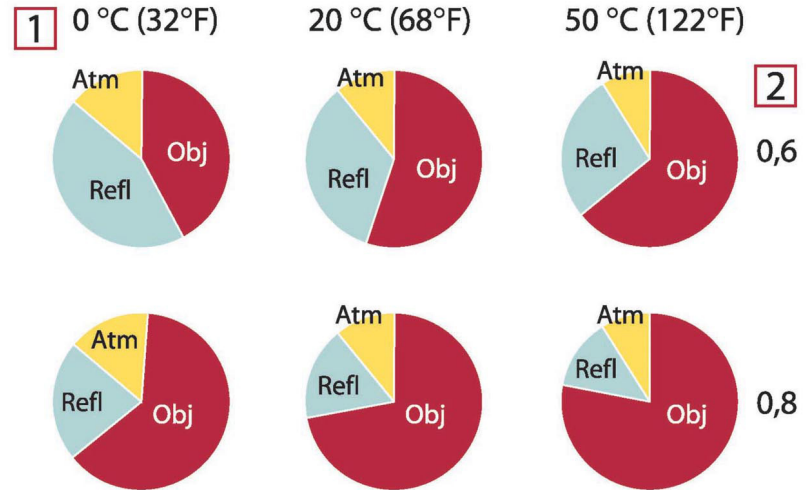

Figure 35.3 Relative magnitudes of radiation sources under varying measurement conditions (LW camera). 1: Object temperature; 2: Emittance; Obj: Object radiation; Refl: Reflected radiation; Atm: atmosphere radiation. Fixed parameters: $\tau = 0.88$; $T_{\text{refl}} = 20^\circ\text{C}$ (+68°F); $T_{\text{atm}} = 20^\circ\text{C}$ (+68°F).

This section presents a compilation of emissivity data from the infrared literature and measurements made by FLIR Systems.

36.1 References

1. Mikaél A. Bramson: *Infrared Radiation, A Handbook for Applications*, Plenum press, N.Y.
2. William L. Wolfe, George J. Zissis: *The Infrared Handbook*, Office of Naval Research, Department of Navy, Washington, D.C.
3. Madding, R. P.: *Thermographic Instruments and systems*. Madison, Wisconsin: University of Wisconsin – Extension, Department of Engineering and Applied Science.
4. William L. Wolfe: *Handbook of Military Infrared Technology*, Office of Naval Research, Department of Navy, Washington, D.C.
5. Jones, Smith, Probert: *External thermography of buildings...*, Proc. of the Society of Photo-Optical Instrumentation Engineers, vol.110, Industrial and Civil Applications of Infrared Technology, June 1977 London.
6. Paljak, Pettersson: *Thermography of Buildings*, Swedish Building Research Institute, Stockholm 1972.
7. Vlcek, J: *Determination of emissivity with imaging radiometers and some emissivities at $\lambda = 5 \mu\text{m}$* . Photogrammetric Engineering and Remote Sensing.
8. Kern: *Evaluation of infrared emission of clouds and ground as measured by weather satellites*, Defence Documentation Center, AD 617 417.
9. Öhman, Claes: *Emittansmätningar med AGEMA E-Box*. Teknisk rapport, AGEMA 1999. (Emittance measurements using AGEMA E-Box. Technical report, AGEMA 1999.)
10. Mattei, S., Tang-Kwor, E: *Emissivity measurements for Nextel Velvet coating 811-21 between -36°C AND 82°C* .
11. Lohrengel & Todtenhaupt (1996)
12. ITC Technical publication 32.
13. ITC Technical publication 29.
14. Schuster, Norbert and Kolobrodov, Valentin G. *Infrarotthermographie*. Berlin: Wiley-VCH, 2000.

Note The emissivity values in the table below are recorded using a shortwave (SW) camera. The values should be regarded as recommendations only and used with caution.

36.2 Tables

Table 36.1 T: Total spectrum; SW: 2–5 μm ; LW: 8–14 μm , LLW: 6.5–20 μm ; 1: Material; 2: Specification; 3: Temperature in $^{\circ}\text{C}$; 4: Spectrum; 5: Emissivity; 6: Reference

1	2	3	4	5	6
3M type 35	Vinyl electrical tape (several colors)	< 80	LW	≈ 0.96	13
3M type 88	Black vinyl electrical tape	< 105	LW	≈ 0.96	13
3M type 88	Black vinyl electrical tape	< 105	MW	< 0.96	13
3M type Super 33+	Black vinyl electrical tape	< 80	LW	≈ 0.96	13
Aluminum	anodized sheet	100	T	0.55	2
Aluminum	anodized, black, dull	70	SW	0.67	9
Aluminum	anodized, black, dull	70	LW	0.95	9
Aluminum	anodized, light gray, dull	70	SW	0.61	9

Table 36.1 T: Total spectrum; SW: 2–5 μm ; LW: 8–14 μm , LLW: 6.5–20 μm ; 1: Material; 2: Specification; 3: Temperature in $^{\circ}\text{C}$; 4: Spectrum; 5: Emissivity; 6: Reference (continued)

1	2	3	4	5	6
Aluminum	anodized, light gray, dull	70	LW	0.97	9
Aluminum	as received, plate	100	T	0.09	4
Aluminum	as received, sheet	100	T	0.09	2
Aluminum	cast, blast cleaned	70	SW	0.47	9
Aluminum	cast, blast cleaned	70	LW	0.46	9
Aluminum	dipped in HNO_3 , plate	100	T	0.05	4
Aluminum	foil	27	10 μm	0.04	3
Aluminum	foil	27	3 μm	0.09	3
Aluminum	oxidized, strongly	50–500	T	0.2–0.3	1
Aluminum	polished	50–100	T	0.04–0.06	1
Aluminum	polished plate	100	T	0.05	4
Aluminum	polished, sheet	100	T	0.05	2
Aluminum	rough surface	20–50	T	0.06–0.07	1
Aluminum	roughened	27	10 μm	0.18	3
Aluminum	roughened	27	3 μm	0.28	3
Aluminum	sheet, 4 samples differently scratched	70	SW	0.05–0.08	9
Aluminum	sheet, 4 samples differently scratched	70	LW	0.03–0.06	9
Aluminum	vacuum deposited	20	T	0.04	2
Aluminum	weathered, heavily	17	SW	0.83–0.94	5
Aluminum bronze		20	T	0.60	1
Aluminum hydroxide	powder		T	0.28	1
Aluminum oxide	activated, powder		T	0.46	1
Aluminum oxide	pure, powder (alumina)		T	0.16	1
Asbestos	board	20	T	0.96	1
Asbestos	fabric		T	0.78	1
Asbestos	floor tile	35	SW	0.94	7
Asbestos	paper	40–400	T	0.93–0.95	1
Asbestos	powder		T	0.40–0.60	1
Asbestos	slate	20	T	0.96	1
Asphalt paving		4	LLW	0.967	8
Brass	dull, tarnished	20–350	T	0.22	1
Brass	oxidized	100	T	0.61	2
Brass	oxidized	70	SW	0.04–0.09	9
Brass	oxidized	70	LW	0.03–0.07	9
Brass	oxidized at 600 $^{\circ}\text{C}$	200–600	T	0.59–0.61	1

Table 36.1 T: Total spectrum; SW: 2–5 µm; LW: 8–14 µm, LLW: 6.5–20 µm; 1: Material; 2: Specification; 3: Temperature in °C; 4: Spectrum; 5: Emissivity; 6: Reference (continued)

1	2	3	4	5	6
Brass	polished	200	T	0.03	1
Brass	polished, highly	100	T	0.03	2
Brass	rubbed with 80-grit emery	20	T	0.20	2
Brass	sheet, rolled	20	T	0.06	1
Brass	sheet, worked with emery	20	T	0.2	1
Brick	alumina	17	SW	0.68	5
Brick	common	17	SW	0.86–0.81	5
Brick	Dinas silica, glazed, rough	1100	T	0.85	1
Brick	Dinas silica, refractory	1000	T	0.66	1
Brick	Dinas silica, unglazed, rough	1000	T	0.80	1
Brick	firebrick	17	SW	0.68	5
Brick	fireclay	1000	T	0.75	1
Brick	fireclay	1200	T	0.59	1
Brick	fireclay	20	T	0.85	1
Brick	masonry	35	SW	0.94	7
Brick	masonry, plastered	20	T	0.94	1
Brick	red, common	20	T	0.93	2
Brick	red, rough	20	T	0.88–0.93	1
Brick	refractory, corundum	1000	T	0.46	1
Brick	refractory, magnesite	1000–1300	T	0.38	1
Brick	refractory, strongly radiating	500–1000	T	0.8–0.9	1
Brick	refractory, weakly radiating	500–1000	T	0.65–0.75	1
Brick	silica, 95% SiO ₂	1230	T	0.66	1
Brick	sillimanite, 33% SiO ₂ , 64% Al ₂ O ₃	1500	T	0.29	1
Brick	waterproof	17	SW	0.87	5
Bronze	phosphor bronze	70	SW	0.08	9
Bronze	phosphor bronze	70	LW	0.06	9
Bronze	polished	50	T	0.1	1
Bronze	porous, rough	50–150	T	0.55	1
Bronze	powder		T	0.76–0.80	1
Carbon	candle soot	20	T	0.95	2
Carbon	charcoal powder		T	0.96	1
Carbon	graphite powder		T	0.97	1
Carbon	graphite, filed surface	20	T	0.98	2
Carbon	lampblack	20–400	T	0.95–0.97	1

Table 36.1 T: Total spectrum; SW: 2–5 µm; LW: 8–14 µm, LLW: 6.5–20 µm; 1: Material; 2: Specification; 3: Temperature in °C; 4: Spectrum; 5: Emissivity; 6: Reference (continued)

1	2	3	4	5	6
Chipboard	untreated	20	SW	0.90	6
Chromium	polished	50	T	0.10	1
Chromium	polished	500–1000	T	0.28–0.38	1
Clay	fired	70	T	0.91	1
Cloth	black	20	T	0.98	1
Concrete		20	T	0.92	2
Concrete	dry	36	SW	0.95	7
Concrete	rough	17	SW	0.97	5
Concrete	walkway	5	LLW	0.974	8
Copper	commercial, burnished	20	T	0.07	1
Copper	electrolytic, carefully polished	80	T	0.018	1
Copper	electrolytic, polished	–34	T	0.006	4
Copper	molten	1100–1300	T	0.13–0.15	1
Copper	oxidized	50	T	0.6–0.7	1
Copper	oxidized to blackness		T	0.88	1
Copper	oxidized, black	27	T	0.78	4
Copper	oxidized, heavily	20	T	0.78	2
Copper	polished	50–100	T	0.02	1
Copper	polished	100	T	0.03	2
Copper	polished, commercial	27	T	0.03	4
Copper	polished, mechanical	22	T	0.015	4
Copper	pure, carefully prepared surface	22	T	0.008	4
Copper	scraped	27	T	0.07	4
Copper dioxide	powder		T	0.84	1
Copper oxide	red, powder		T	0.70	1
Ebonite			T	0.89	1
Emery	coarse	80	T	0.85	1
Enamel		20	T	0.9	1
Enamel	lacquer	20	T	0.85–0.95	1
Fiber board	hard, untreated	20	SW	0.85	6
Fiber board	masonite	70	SW	0.75	9
Fiber board	masonite	70	LW	0.88	9
Fiber board	particle board	70	SW	0.77	9
Fiber board	particle board	70	LW	0.89	9
Fiber board	porous, untreated	20	SW	0.85	6
Glass pane (float glass)	non-coated	20	LW	0.97	14
Gold	polished	130	T	0.018	1

Table 36.1 T: Total spectrum; SW: 2–5 µm; LW: 8–14 µm, LLW: 6.5–20 µm; 1: Material; 2: Specification; 3: Temperature in °C; 4: Spectrum; 5: Emissivity; 6: Reference (continued)

1	2	3	4	5	6
Gold	polished, carefully	200–600	T	0.02–0.03	1
Gold	polished, highly	100	T	0.02	2
Granite	polished	20	LLW	0.849	8
Granite	rough	21	LLW	0.879	8
Granite	rough, 4 different samples	70	SW	0.95–0.97	9
Granite	rough, 4 different samples	70	LW	0.77–0.87	9
Gypsum		20	T	0.8–0.9	1
Ice: See Water					
Iron and steel	cold rolled	70	SW	0.20	9
Iron and steel	cold rolled	70	LW	0.09	9
Iron and steel	covered with red rust	20	T	0.61–0.85	1
Iron and steel	electrolytic	100	T	0.05	4
Iron and steel	electrolytic	22	T	0.05	4
Iron and steel	electrolytic	260	T	0.07	4
Iron and steel	electrolytic, carefully polished	175–225	T	0.05–0.06	1
Iron and steel	freshly worked with emery	20	T	0.24	1
Iron and steel	ground sheet	950–1100	T	0.55–0.61	1
Iron and steel	heavily rusted sheet	20	T	0.69	2
Iron and steel	hot rolled	130	T	0.60	1
Iron and steel	hot rolled	20	T	0.77	1
Iron and steel	oxidized	100	T	0.74	4
Iron and steel	oxidized	100	T	0.74	1
Iron and steel	oxidized	1227	T	0.89	4
Iron and steel	oxidized	125–525	T	0.78–0.82	1
Iron and steel	oxidized	200	T	0.79	2
Iron and steel	oxidized	200–600	T	0.80	1
Iron and steel	oxidized strongly	50	T	0.88	1
Iron and steel	oxidized strongly	500	T	0.98	1
Iron and steel	polished	100	T	0.07	2
Iron and steel	polished	400–1000	T	0.14–0.38	1
Iron and steel	polished sheet	750–1050	T	0.52–0.56	1
Iron and steel	rolled sheet	50	T	0.56	1
Iron and steel	rolled, freshly	20	T	0.24	1
Iron and steel	rough, plane surface	50	T	0.95–0.98	1
Iron and steel	rusted red, sheet	22	T	0.69	4
Iron and steel	rusted, heavily	17	SW	0.96	5
Iron and steel	rusty, red	20	T	0.69	1
Iron and steel	shiny oxide layer, sheet,	20	T	0.82	1

Table 36.1 T: Total spectrum; SW: 2–5 μm ; LW: 8–14 μm , LLW: 6.5–20 μm ; 1: Material; 2: Specification; 3: Temperature in $^{\circ}\text{C}$; 4: Spectrum; 5: Emissivity; 6: Reference (continued)

1	2	3	4	5	6
Iron and steel	shiny, etched	150	T	0.16	1
Iron and steel	wrought, carefully polished	40–250	T	0.28	1
Iron galvanized	heavily oxidized	70	SW	0.64	9
Iron galvanized	heavily oxidized	70	LW	0.85	9
Iron galvanized	sheet	92	T	0.07	4
Iron galvanized	sheet, burnished	30	T	0.23	1
Iron galvanized	sheet, oxidized	20	T	0.28	1
Iron tinned	sheet	24	T	0.064	4
Iron, cast	casting	50	T	0.81	1
Iron, cast	ingots	1000	T	0.95	1
Iron, cast	liquid	1300	T	0.28	1
Iron, cast	machined	800–1000	T	0.60–0.70	1
Iron, cast	oxidized	100	T	0.64	2
Iron, cast	oxidized	260	T	0.66	4
Iron, cast	oxidized	38	T	0.63	4
Iron, cast	oxidized	538	T	0.76	4
Iron, cast	oxidized at 600 $^{\circ}\text{C}$	200–600	T	0.64–0.78	1
Iron, cast	polished	200	T	0.21	1
Iron, cast	polished	38	T	0.21	4
Iron, cast	polished	40	T	0.21	2
Iron, cast	unworked	900–1100	T	0.87–0.95	1
Krylon Ultra-flat black 1602	Flat black	Room temperature up to 175	LW	≈ 0.96	12
Krylon Ultra-flat black 1602	Flat black	Room temperature up to 175	MW	≈ 0.97	12
Lacquer	3 colors sprayed on Aluminum	70	SW	0.50–0.53	9
Lacquer	3 colors sprayed on Aluminum	70	LW	0.92–0.94	9
Lacquer	Aluminum on rough surface	20	T	0.4	1
Lacquer	bakelite	80	T	0.83	1
Lacquer	black, dull	40–100	T	0.96–0.98	1
Lacquer	black, matte	100	T	0.97	2
Lacquer	black, shiny, sprayed on iron	20	T	0.87	1
Lacquer	heat-resistant	100	T	0.92	1
Lacquer	white	100	T	0.92	2
Lacquer	white	40–100	T	0.8–0.95	1
Lead	oxidized at 200 $^{\circ}\text{C}$	200	T	0.63	1
Lead	oxidized, gray	20	T	0.28	1
Lead	oxidized, gray	22	T	0.28	4
Lead	shiny	250	T	0.08	1

Table 36.1 T: Total spectrum; SW: 2–5 µm; LW: 8–14 µm, LLW: 6.5–20 µm; 1: Material; 2: Specification; 3: Temperature in °C; 4: Spectrum; 5: Emissivity; 6: Reference (continued)

1	2	3	4	5	6
Lead	unoxidized, polished	100	T	0.05	4
Lead red		100	T	0.93	4
Lead red, powder		100	T	0.93	1
Leather	tanned		T	0.75–0.80	1
Lime			T	0.3–0.4	1
Magnesium		22	T	0.07	4
Magnesium		260	T	0.13	4
Magnesium		538	T	0.18	4
Magnesium	polished	20	T	0.07	2
Magnesium powder			T	0.86	1
Molybdenum		1500–2200	T	0.19–0.26	1
Molybdenum		600–1000	T	0.08–0.13	1
Molybdenum	filament	700–2500	T	0.1–0.3	1
Mortar		17	SW	0.87	5
Mortar	dry	36	SW	0.94	7
Nextel Velvet 811-21 Black	Flat black	–60–150	LW	> 0.97	10 and 11
Nichrome	rolled	700	T	0.25	1
Nichrome	sandblasted	700	T	0.70	1
Nichrome	wire, clean	50	T	0.65	1
Nichrome	wire, clean	500–1000	T	0.71–0.79	1
Nichrome	wire, oxidized	50–500	T	0.95–0.98	1
Nickel	bright matte	122	T	0.041	4
Nickel	commercially pure, polished	100	T	0.045	1
Nickel	commercially pure, polished	200–400	T	0.07–0.09	1
Nickel	electrolytic	22	T	0.04	4
Nickel	electrolytic	260	T	0.07	4
Nickel	electrolytic	38	T	0.06	4
Nickel	electrolytic	538	T	0.10	4
Nickel	electroplated on iron, polished	22	T	0.045	4
Nickel	electroplated on iron, unpolished	20	T	0.11–0.40	1
Nickel	electroplated on iron, unpolished	22	T	0.11	4
Nickel	electroplated, polished	20	T	0.05	2
Nickel	oxidized	1227	T	0.85	4
Nickel	oxidized	200	T	0.37	2
Nickel	oxidized	227	T	0.37	4
Nickel	oxidized at 600°C	200–600	T	0.37–0.48	1
Nickel	polished	122	T	0.045	4

Table 36.1 T: Total spectrum; SW: 2–5 µm; LW: 8–14 µm, LLW: 6.5–20 µm; 1: Material; 2: Specification; 3: Temperature in °C; 4: Spectrum; 5: Emissivity; 6: Reference (continued)

1	2	3	4	5	6
Nickel	wire	200–1000	T	0.1–0.2	1
Nickel oxide		1000–1250	T	0.75–0.86	1
Nickel oxide		500–650	T	0.52–0.59	1
Oil, lubricating	0.025 mm film	20	T	0.27	2
Oil, lubricating	0.050 mm film	20	T	0.46	2
Oil, lubricating	0.125 mm film	20	T	0.72	2
Oil, lubricating	film on Ni base: Ni base only	20	T	0.05	2
Oil, lubricating	thick coating	20	T	0.82	2
Paint	8 different colors and qualities	70	SW	0.88–0.96	9
Paint	8 different colors and qualities	70	LW	0.92–0.94	9
Paint	Aluminum, vari- ous ages	50–100	T	0.27–0.67	1
Paint	cadmium yellow		T	0.28–0.33	1
Paint	chrome green		T	0.65–0.70	1
Paint	cobalt blue		T	0.7–0.8	1
Paint	oil	17	SW	0.87	5
Paint	oil based, aver- age of 16 colors	100	T	0.94	2
Paint	oil, black flat	20	SW	0.94	6
Paint	oil, black gloss	20	SW	0.92	6
Paint	oil, gray flat	20	SW	0.97	6
Paint	oil, gray gloss	20	SW	0.96	6
Paint	oil, various colors	100	T	0.92–0.96	1
Paint	plastic, black	20	SW	0.95	6
Paint	plastic, white	20	SW	0.84	6
Paper	4 different colors	70	SW	0.68–0.74	9
Paper	4 different colors	70	LW	0.92–0.94	9
Paper	black		T	0.90	1
Paper	black, dull		T	0.94	1
Paper	black, dull	70	SW	0.86	9
Paper	black, dull	70	LW	0.89	9
Paper	blue, dark		T	0.84	1
Paper	coated with black lacquer		T	0.93	1
Paper	green		T	0.85	1
Paper	red		T	0.76	1
Paper	white	20	T	0.7–0.9	1
Paper	white bond	20	T	0.93	2
Paper	white, 3 different glosses	70	SW	0.76–0.78	9
Paper	white, 3 different glosses	70	LW	0.88–0.90	9

Table 36.1 T: Total spectrum; SW: 2–5 µm; LW: 8–14 µm, LLW: 6.5–20 µm; 1: Material; 2: Specification; 3: Temperature in °C; 4: Spectrum; 5: Emissivity; 6: Reference (continued)

1	2	3	4	5	6
Paper	yellow		T	0.72	1
Plaster		17	SW	0.86	5
Plaster	plasterboard, untreated	20	SW	0.90	6
Plaster	rough coat	20	T	0.91	2
Plastic	glass fibre laminate (printed circ. board)	70	SW	0.94	9
Plastic	glass fibre laminate (printed circ. board)	70	LW	0.91	9
Plastic	polyurethane isolation board	70	LW	0.55	9
Plastic	polyurethane isolation board	70	SW	0.29	9
Plastic	PVC, plastic floor, dull, structured	70	SW	0.94	9
Plastic	PVC, plastic floor, dull, structured	70	LW	0.93	9
Platinum		100	T	0.05	4
Platinum		1000–1500	T	0.14–0.18	1
Platinum		1094	T	0.18	4
Platinum		17	T	0.016	4
Platinum		22	T	0.03	4
Platinum		260	T	0.06	4
Platinum		538	T	0.10	4
Platinum	pure, polished	200–600	T	0.05–0.10	1
Platinum	ribbon	900–1100	T	0.12–0.17	1
Platinum	wire	1400	T	0.18	1
Platinum	wire	500–1000	T	0.10–0.16	1
Platinum	wire	50–200	T	0.06–0.07	1
Porcelain	glazed	20	T	0.92	1
Porcelain	white, shiny		T	0.70–0.75	1
Rubber	hard	20	T	0.95	1
Rubber	soft, gray, rough	20	T	0.95	1
Sand			T	0.60	1
Sand		20	T	0.90	2
Sandstone	polished	19	LLW	0.909	8
Sandstone	rough	19	LLW	0.935	8
Silver	polished	100	T	0.03	2
Silver	pure, polished	200–600	T	0.02–0.03	1
Skin	human	32	T	0.98	2
Slag	boiler	0–100	T	0.97–0.93	1
Slag	boiler	1400–1800	T	0.69–0.67	1
Slag	boiler	200–500	T	0.89–0.78	1
Slag	boiler	600–1200	T	0.76–0.70	1
Snow: See Water					

Table 36.1 T: Total spectrum; SW: 2–5 µm; LW: 8–14 µm, LLW: 6.5–20 µm; 1: Material; 2: Specification; 3: Temperature in °C; 4: Spectrum; 5: Emissivity; 6: Reference (continued)

1	2	3	4	5	6
Soil	dry	20	T	0.92	2
Soil	saturated with water	20	T	0.95	2
Stainless steel	alloy, 8% Ni, 18% Cr	500	T	0.35	1
Stainless steel	rolled	700	T	0.45	1
Stainless steel	sandblasted	700	T	0.70	1
Stainless steel	sheet, polished	70	SW	0.18	9
Stainless steel	sheet, polished	70	LW	0.14	9
Stainless steel	sheet, untreated, somewhat scratched	70	SW	0.30	9
Stainless steel	sheet, untreated, somewhat scratched	70	LW	0.28	9
Stainless steel	type 18-8, buffed	20	T	0.16	2
Stainless steel	type 18-8, oxidized at 800°C	60	T	0.85	2
Stucco	rough, lime	10–90	T	0.91	1
Styrofoam	insulation	37	SW	0.60	7
Tar			T	0.79–0.84	1
Tar	paper	20	T	0.91–0.93	1
Tile	glazed	17	SW	0.94	5
Tin	burnished	20–50	T	0.04–0.06	1
Tin	tin-plated sheet iron	100	T	0.07	2
Titanium	oxidized at 540°C	1000	T	0.60	1
Titanium	oxidized at 540°C	200	T	0.40	1
Titanium	oxidized at 540°C	500	T	0.50	1
Titanium	polished	1000	T	0.36	1
Titanium	polished	200	T	0.15	1
Titanium	polished	500	T	0.20	1
Tungsten		1500–2200	T	0.24–0.31	1
Tungsten		200	T	0.05	1
Tungsten		600–1000	T	0.1–0.16	1
Tungsten	filament	3300	T	0.39	1
Varnish	flat	20	SW	0.93	6
Varnish	on oak parquet floor	70	SW	0.90	9
Varnish	on oak parquet floor	70	LW	0.90–0.93	9
Wallpaper	slight pattern, light gray	20	SW	0.85	6
Wallpaper	slight pattern, red	20	SW	0.90	6
Water	distilled	20	T	0.96	2
Water	frost crystals	–10	T	0.98	2
Water	ice, covered with heavy frost	0	T	0.98	1

Table 36.1 T: Total spectrum; SW: 2–5 μm ; LW: 8–14 μm , LLW: 6.5–20 μm ; 1: Material; 2: Specification; 3: Temperature in $^{\circ}\text{C}$; 4: Spectrum; 5: Emissivity; 6: Reference (continued)

1	2	3	4	5	6
Water	ice, smooth	0	T	0.97	1
Water	ice, smooth	-10	T	0.96	2
Water	layer >0.1 mm thick	0–100	T	0.95–0.98	1
Water	snow		T	0.8	1
Water	snow	-10	T	0.85	2
Wood		17	SW	0.98	5
Wood		19	LLW	0.962	8
Wood	ground		T	0.5–0.7	1
Wood	pine, 4 different samples	70	SW	0.67–0.75	9
Wood	pine, 4 different samples	70	LW	0.81–0.89	9
Wood	planed	20	T	0.8–0.9	1
Wood	planed oak	20	T	0.90	2
Wood	planed oak	70	SW	0.77	9
Wood	planed oak	70	LW	0.88	9
Wood	plywood, smooth, dry	36	SW	0.82	7
Wood	plywood, untreated	20	SW	0.83	6
Wood	white, damp	20	T	0.7–0.8	1
Zinc	oxidized at 400 $^{\circ}\text{C}$	400	T	0.11	1
Zinc	oxidized surface	1000–1200	T	0.50–0.60	1
Zinc	polished	200–300	T	0.04–0.05	1
Zinc	sheet	50	T	0.20	1

A note on the technical production of this publication

This publication was produced using XML — the eXtensible Markup Language. For more information about XML, please visit <http://www.w3.org/XML/>

A note on the typeface used in this publication

This publication was typeset using Linotype Helvetica™ World. Helvetica™ was designed by Max Miedinger (1910–1980)

LOEF (List Of Effective Files)

T501000.xml; en-US; AP; 36066; 2016-05-31
T505552.xml; en-US; 9599; 2013-11-05
T505699.xml; en-US; 32147; 2016-01-12
T505469.xml; en-US; 23215; 2015-02-19
T505013.xml; en-US; 35155; 2016-04-21
T505652.xml; en-US; 24907; 2015-04-22
T505223.xml; en-US; 32183; 2016-01-13
T505193.xml; en-US; 32085; 2016-01-11
T505385.xml; en-US; 32063; 2016-01-08
T505653.xml; en-US; 32085; 2016-01-11
T505422.xml; en-US; 32063; 2016-01-08
T505654.xml; en-US; 32189; 2016-01-13
T505664.xml; en-US; 32032; 2016-01-07
T505387.xml; en-US; 32063; 2016-01-08
T505656.xml; en-US; 32522; 2016-01-19
T505657.xml; en-US; 32182; 2016-01-13
T505658.xml; en-US; 32182; 2016-01-13
T505411.xml; en-US; 32032; 2016-01-07
T505659.xml; en-US; 32063; 2016-01-08
T505660.xml; en-US; 32085; 2016-01-11
T505661.xml; en-US; 32047; 2016-01-08
T505662.xml; en-US; 32063; 2016-01-08
T505765.xml; en-US; 29249; 2015-10-09
T505663.xml; en-US; 32032; 2016-01-07
T505788.xml; en-US; 35985; 2016-05-30
T505412.xml; en-US; 32063; 2016-01-08
T505470.xml; en-US; 12154; 2014-03-06
T505012.xml; en-US; 32556; 2016-01-20
T505007.xml; en-US; 35155; 2016-04-21
T505004.xml; en-US; 35155; 2016-04-21
T505000.xml; en-US; 35155; 2016-04-21
T505005.xml; en-US; 35155; 2016-04-21
T505001.xml; en-US; 32554; 2016-01-20
T505006.xml; en-US; 32555; 2016-01-20
T505002.xml; en-US; 33518; 2016-02-18



Website

<http://www.flir.com>

Customer support

<http://support.flir.com>

Copyright

© 2016, FLIR Systems, Inc. All rights reserved worldwide.

Disclaimer

Specifications subject to change without further notice. Models and accessories subject to regional market considerations. License procedures may apply. Products described herein may be subject to US Export Regulations. Please refer to exportquestions@flir.com with any questions.

Publ. No.: T559879
Release: AP
Commit: 36066
Head: 36066
Language: en-US
Modified: 2016-05-31
Formatted: 2016-05-31