

# Fieldpiece

## Wireless Clamp Meter

### OPERATOR'S MANUAL

Model SC460

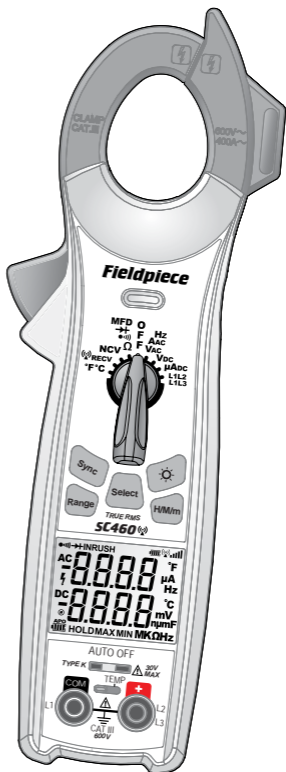

# Description

The SC460 is an essential clamp meter with wireless functionality for the HVACR professional. Receive wireless measurements from Fieldpiece accessory heads and wireless transmitters from anywhere on the jobsite. For instance, receive an indoor delta T temperature measurement wirelessly from a Fieldpiece transmitter while you work at the condenser. Send your electrical measurements to the Job Link™ mobile app via the Fieldpiece JL2 Transmitter. (See Wireless section for more details).

Hang your SC460 clamp meter to any metallic surface with the heavy-duty magnet. See both voltage and amperage readings at the same time on the big dual display, even in low light conditions using the bright blue backlight.

Verify the order of 3-phase voltage lines with just two leads. Capture L1L2 and L1L3 to check that motor lines are correctly installed with Phase Rotation test.

Take more accurate VAC and AAC readings on variable frequency drives with True RMS sensing technology. Measure the starting amp draw of a compressor with Inrush current mode.

Illuminate the way with a powerful LED built into the clamp jaw. Easily see your measurements with

the bright blue backlight on the display.

Take measurements more safely with one hand using the single test lead holder. Test leads come with removable gold plated tips to connect with Fieldpiece accessory heads.

The SC460 clamp meter is built to withstand the rigors of HVACR field work with high impact plastic and a display you can read in very hot or very cold environments.

## What's Included

- SC460 Wireless Clamp Meter
- ADLS2 Deluxe Test Leads Kit
- ASA2 Alligator Clips
- ATB1 Type K Thermocouple
- 1 Velcro Strap
- 9V Alkaline Battery (Not installed)
- ANC12 Protective Padded Case
- Operator's Manual

# Quick Start

1. For electrical testing, connect test leads to black "COM" and red "+" jacks.
2. Rotate the dial to your desired measurement.
3. Connect to test points and read measurement.
4. For temperature testing, remove test leads, slide TEMP switch to the right and connect a Type K thermocouple.

# Certifications



UL 61010-1, Third Edition



EN61010-1, EN61010-2-032  
EN61010-2-033, EMC EN61326-1



FCC ID: VEARF915A



C-Tick (N22675)



WEEE

CATIII 600V, class II and pollution degree 2 indoor use comply with CE, RoHS compliant.

CATIII is designated for measurements performed in the building installation.

# Specifications

**Display:** 10000 count dual display

**Backlight:** 5 minute duration with auto-off. Blue color

**Overrange:** (OL) or (-OL) is displayed

**Measurement rate:** 3.3 times per second, nominal

**Zero:** Automatic

**Operating environment:** 32°F to 122°F (0°C to 50°C) at <70%RH

**Storage temperature:** -4°F to 140°F (-20°C to 60°C), 0 to 80%RH (with battery removed)

**Accuracy:** Stated accuracy @ 73°F±9°F (23°C±5°C), <75%RH

**Temperature coefficient:** 0.1 x (specified accuracy) per °C [0°C to 19°C (32°F to 66°F), 28°C to 50°C (82°F to 122°F)]

**AP0 (Auto Power Off):** Approx. 30 minutes

**Power:** Single standard 9-volt battery, NEDA 1604, JIS 006P, IEC 6F22

**Battery life:** 100 hours typical alkaline

**Low battery indication:** Battery icon blinks and "batt" is displayed when the battery voltage drops below the operating level

**Dimensions:** 233mm(H) x 79mm(W) x 48mm(D)

**Weight:** Approx. 315g including battery

**Altitude:** Up to 6562 ft (2000m)









**Overload protection:** 600VDC or 600VAC rms unless otherwise stated

**Test leads:** Use UL listed test leads that comply to UL61010-031 rated CATIII 600V or above. Included test leads are gold-plated and have removable safety caps.

**Please operate the instrument following all instructions of the operator's manual to avoid impairing the safety of the product.**



# Display Icons

	Battery Life Monitor
	Auto Power Off Enabled
	High Voltage Warning (>30VAC/VDC)
	Manual Ranging
<b>HOLD</b>	Data Hold
<b>MAX</b>	Maximum
<b>MIN</b>	Minimum
<b>INRUSH</b>	Inrush AAC
	Wireless Enabled (searching if flashing)
	Wireless Signal Strength Bars
<b>°F</b>	Fahrenheit
<b>°C</b>	Celsius
	Continuity Test
	Diode Test
<b>Hz</b>	Frequency (Hertz)
<b>Ω</b>	Resistance Test (Ohms)
<b>F</b>	Capacitance Test (farads)
<b>μA</b>	Microamps DC
<b>n</b>	Nano Unit ( $10^{-9}$ , one billionth)
<b>μ</b>	Micro Unit ( $10^{-6}$ , one millionth)
<b>m</b>	Milli Unit ( $10^{-3}$ , one thousandth)
<b>K</b>	Kilo Unit ( $10^3$ , one thousand)
<b>M</b>	Mega Unit ( $10^6$ , one million)
<b>AC</b>	Alternating Current
<b>DC</b>	Direct Current



## Easy to Read Display

Easily see your measurements on the big dual display. You'll never miss a reading no matter the lighting with the bright blue backlight to illuminate the way.

# Test Parameters

## Volts AC (VAC) True RMS (50-500Hz)

Test power lines (120, 220, 480VAC), test 24VAC going to controls, and test for transformer failure.

**Ranges:** 1000mV, 10V, 100V, 600V **Resolution:** 0.1mV

**Accuracy:**  $\pm(1.2\% + 10)$  1000mV, 10, 100V range  
 $\pm(1.5\% + 10)$  600V range

**Minimum Input Voltage Range:** >20 digits

**Crest factor:**  $\leq 3$

**Audio/Visual Hi-V indicator:** >30VAC/VDC

**Input impedance:**  $5M\Omega$

**Overload Protection:** 600VDC or 600VAC rms

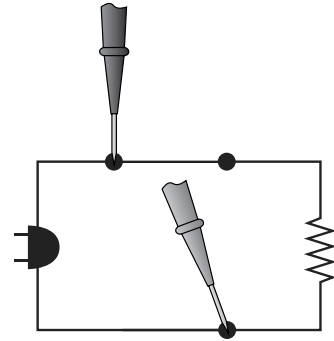
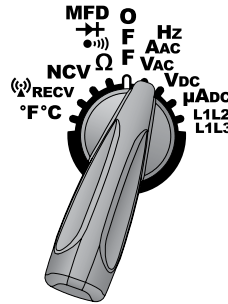

## Volts DC (VDC)

Select VDC and measure DC voltages on circuit boards on more advanced HVACR systems and logic control boards.

**Ranges:** 1000mV, 10V, 100V, 600V **Resolution:** 0.1mV

**Accuracy:**  $\pm(0.5\% + 5)$

**Input impedance:**  $5M\Omega$

**Overload Protection:** 600VDC or 600VAC rms

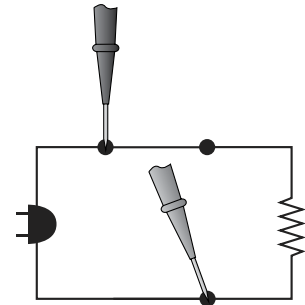
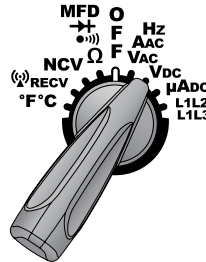

## Non Contact Voltage (NCV)

Use NCV to check 24VAC from a thermostat or live voltage up to 600VAC. Always test a known live source before using. A segment graph and RED LED will display the presence of voltage. An audible beep increases from intermittent to continuous as intensity of field (EF) increases.

**AC Voltage Detection Range:** 24VAC to 600VAC (50-60Hz)

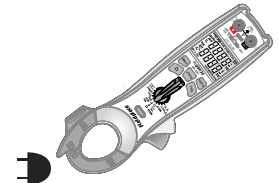
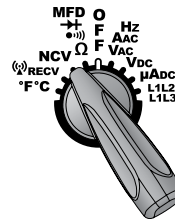

## Amps AC (AAC) True RMS (50-60Hz)

Test any isolated power line. Press SELECT once on VAC/AAC/Hz position. Read AAC in upper display and VAC on the lower display at the same time.

**Range:** 100A, 400A **Resolution:** 0.01A **Crest factor:**  $\leq 3$

**Accuracy:**  $\pm(2.0\% + 10)$

**Minimum Input Current Range:** >20 digits

**Overload Protection:** 400AAC **Jaw Opening:** 1.2in (30 mm)

## Frequency (Hz) Through Clamp

Measure Hz on variable frequency drive motors. Turn dial to VAC/AAC/Hz and press SELECT twice. Hz will show in upper display and VAC on the lower display at the same time.

**Range:** 10Hz to 400Hz **Resolution:** 0.1Hz

**Accuracy:**  $\pm(0.1\% + 5)$

**Minimum current range:** >10AAC (10 to 100Hz); >25AAC (100 to 400Hz) on 100AAC range; >50AAC (10 to 400Hz) on 400AAC range.

**Overload Protection:** 400AAC

## Inrush AAC Current

Inrush mode captures the starting amp draw of a motor. Starting amp draw can assist in diagnosing a motor before it fails.

### Activate Inrush mode

- 1 Rotate selector switch to VAC/AAC/Hz.
- 2 Press SELECT once to show AAC on upper display. Press INRUSH on the right side of meter to activate.
- 3 Clamp meter around the motor's start wire. Turn motor on. The starting amp draw will hold on the upper display.
- 4 Press INRUSH to reset the test. Press INRUSH for 2 seconds to exit Inrush mode.

**Inrush measurement period:** 100-milliseconds

**Minimum input:** >2A on 100A range; >20A on 400A range

△ Note: AAC or Hz through the clamp and VAC through the test leads can be measured simultaneously. However, if only AAC, Frequency (Hz), or Inrush AAC is measured through the clamp, test leads and thermocouples must be unplugged from the meter.

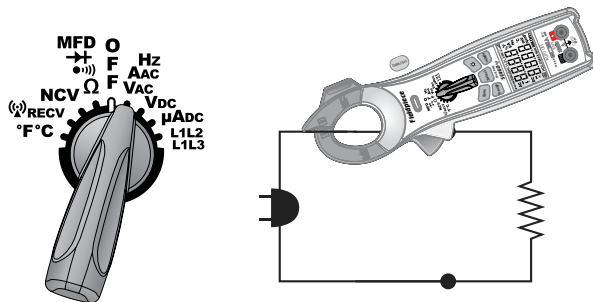

Amps AC (AAC), Frequency (Hz) through the clamp and Inrush AAC current is measured in the VAC/AAC/Hz switch position shown above.

# MicroAmps DC ( $\mu$ ADC)

Microamps for flame rectifier diode test on a heater control. Connect leads between flame sensor probe and control module and turn heating unit on to read  $\mu$ A measurement. When the flame is on, there should be a measurable  $\mu$ ADC signal, typically under  $10\mu$ ADC. Compare measurement to manufacturer's specification to determine if replacement is necessary.

**Ranges:**  $1000\mu$ A **Resolution:**  $0.1\mu$ A

**Accuracy:**  $\pm(1.0\% + 5)$  **Volts burden:** 5V

**Overload Protection:** 600VDC or 600VAC rms

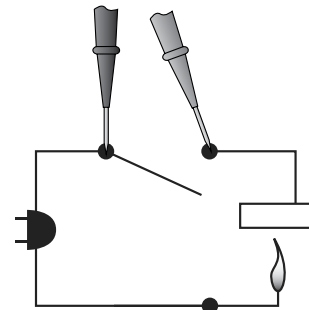
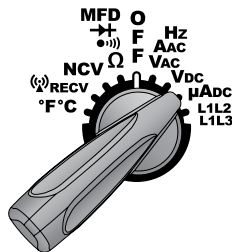

# Capacitance (MFD)

Set to MFD to test motor start and run capacitors. Capacitors are one of the most failure prone components in a HVACR system. Disconnect from power and resistors between terminals. Discharge capacitor before testing. If dI.S.C is displayed, the capacitor needs to be fully discharged to test. Press SELECT three times to enter Capacitance mode.

**Ranges:** 10nF, 100nF, 1000nF,  $10\mu$ F,  $100\mu$ F,  $1000\mu$ F, 10mF

**Accuracy:**  $\pm(3\% + 15)$  10nF,  $\pm(3\% + 5)$  100nF to  $1000\mu$ F,  $\pm(5\% + 5)$  10mF

**Resolution:** 0.01nF **Overload Protection:** 600VDC or 600VAC rms

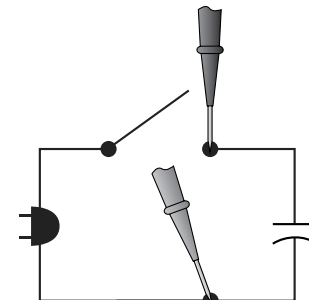
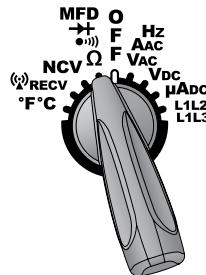

**Discharge Cap First!**



# Resistance ( $\Omega$ )

Used for “ohming out” a compressor. A 0.01 $\Omega$  resolution is useful to test the resistance between the terminal poles because the values are typically very low. Resistance is default test in this switch position.

**Ranges:** 100 $\Omega$ , 1000 $\Omega$ , 10k $\Omega$ , 100k $\Omega$ , 1000k $\Omega$ , 10M $\Omega$ , 50M $\Omega$

**Resolution:** 0.01 $\Omega$

**Accuracy:**  $\pm(1.0\% + 15)$  100 $\Omega$ ,  $\pm(1.0\% + 5)$  1000 $\Omega$  to 100k $\Omega$ ,  $\pm(1.5\% + 5)$  1000k $\Omega$ ,  $\pm(3.0\% + 5)$  10M $\Omega$  to 50M $\Omega$

**Open circuit volts:** -1.1VDC typical, -3.2VDC (100 $\Omega$  range)

**Overload Protection:** 600VDC or 600VAC rms

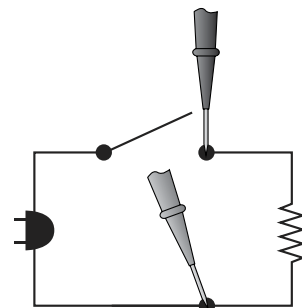
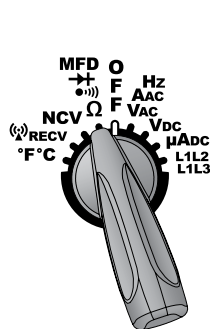

# Continuity ( $\bullet$ )

Use the continuity feature to test if a circuit is open or closed. Use this feature to check isolated fuses as well. A steady “beep” and green LED indicate you have continuity. Press SELECT once to enter Continuity mode.

**Range:** 100 $\Omega$  **Resolution:** 0.01 $\Omega$  **Response time:** 100ms

**Audible beep:** <30 $\Omega$

**Overload Protection:** 600VDC or 600VAC rms

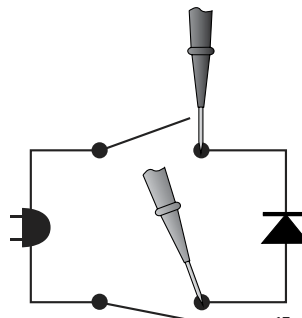
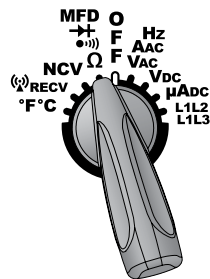

# Diode Test ( $\rightarrow$ )

Test diodes for proper forward and reversed-biased functions. Press SELECT twice to enter Diode mode.

**Test current:** 0.8mA (Approx.) **Accuracy:**  $\pm(1.5\% + 5)$

**Open circuit volts:** 3.2VDC typical **Audible beep:** <0.05V

**Visual Indicator:** Green LED

**Overload Protection:** 600VDC or 600VAC rms

# Temperature

Plug any Type K thermocouple directly into the meter to measure temperature. Measure outdoor dry bulb temperature for target superheat while at the condenser with the Type K thermocouple input.

Cold junction is located inside the meter and allows for accurate measurements even in rapidly changing ambient temperatures (going from rooftop to freezer). No adapter is required.

By default, °F will show on top display and °C on bottom display.

**Range:** -58°F to 2372°F, (-50°C to 1300°C) **Resolution:** 0.1°

**Accuracy:** ±(1°F)\* 32°F to 120°F, ±(1°C) 0°C to 49°C

±(1%+2°F) 32°F to 932°F, ±(1%+1°C) 0°C to 500°C

±(2%+6°F) -58°F to 32°F, ±(2%+3°C) -50°C to 0°C

±(2%+6°F) 932°F to 2372°F, ±(2%+3°C) 500°C to 1300°C

**Sensor type:** Type K thermocouple

**Overload protection:** 30 VDC or 30VAC rms

\*After field calibration

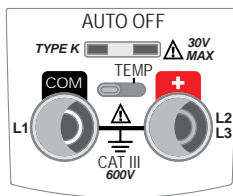
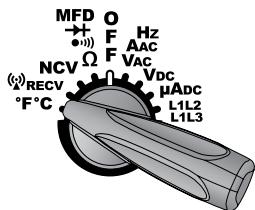

**Unplug Leads and Slide  
TEMP Switch to the Right**

# Temperature Calibration

For accuracies of ±1°F, calibrate both thermocouples to a known temperature. A glass of stabilized ice water is very close to 32°F (0°C) and is usually very convenient but any known temperature can be used. Ideally you should calibrate to a known temperature closest to the temperatures you will be testing.

1. Rotate dial to the °F/°C position.
2. Plug one thermocouple to be calibrated into the Type K input.
3. Unscrew A and B and remove the battery cover.
4. Stabilize a large cup of ice water. Stir the ice with the water until temperature stays at a stable value.
5. Immerse the thermocouple probe and let it stabilize. Keep stirring water to prevent thermocouple from direct contact with ice.
6. Use a small screwdriver to adjust calibration Temp Cal pot below the battery as close to 32°F(0°C) as you would like.

Note: J1-J2 switch is for factory calibration purposes only. Do not switch from J2.

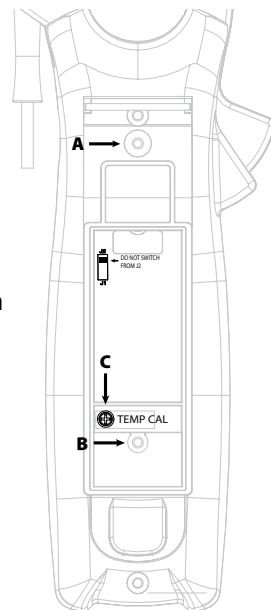

# Phase Rotation Test (L1L2, L1L3)

Connect 3-phase power lines in the correct order to the terminals of a motor to ensure the motor turns in the intended direction. Incorrect wiring can damage some equipment. The terminals on the motor are usually marked L1, L2, and L3; however, the wires supplying power usually are not. Perform a simple phase rotation test with two test leads to quickly identify the order of 3-phase power lines.

**Range:** 80±5 VAC to 600VAC (50Hz to 80Hz) **Resolution:** 0.1V

**Accuracy:** ±(1.5% rdg + 10 dgts)

**Overload Protection:** 600VDC or AC rms

## How to Perform a Phase Rotation Test

### Set Up

Switch to **L1L2** or **L1L3**. Plug black test lead into the COM (L1) port and red test lead to the VΩ (L2 L3) port on the SC460.

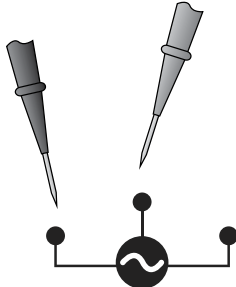
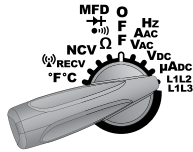

You will see “L1L2” blinking to indicate phase rotation test is ready to begin.



### Step 1

Connect both black and red test leads to any two of the three phase voltage lines in question. The line voltage will hold on the bottom display. Blinking L1 and L2 disappear. L3 will blink on top display to indicate test is ready for Step 2.

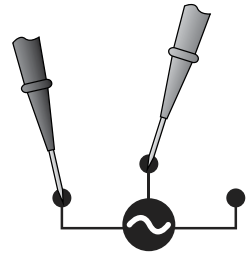

**Important: Step 2 must be performed within 5 seconds of completing Step 1 or “Err” will show and Step 1 must be repeated.**

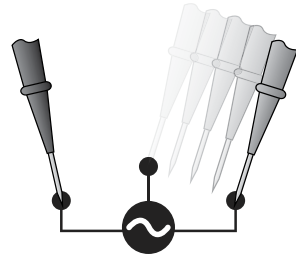

### Step 2

With the black lead still on “L1”, move the red test lead to the third 3-phase voltage line. The line voltage will hold on the bottom display. The top display will show L123 indicating forward or L321 indicating reversed.



Simply swap any two lines to change the direction. You can verify this by performing the test again.



## Phase Rotation Testing Tips

- 1 The measured voltage during phase rotation test must be  $>80.0 \pm 5VAC$ . If not, the phase rotation test can not be performed and "Err" will show on the top display.
- 2 After phase rotation test is complete, press SELECT button to begin a new phase rotation test.
- 3 Be sure to connect test leads to 3-phase voltage lines for at least 2 seconds until voltage reading holds on the bottom display
- 4 Phase rotation test cannot be performed on Hi-frequency voltage signals. Be sure voltage lines are within 50-80Hz to perform the phase rotation test.

# Modular Expandability

Your SC460 is compatible with all Fieldpiece Accessory Heads. With Fieldpiece Accessory Heads, you can measure any available parameter, and read the measurement on your new meter's display in real-time, Hold, Max, and min.

Rotate the selector to VDC and stay in mV range. Remove the probe tips of your test leads, and connect your accessory head (model AAV3 shown).

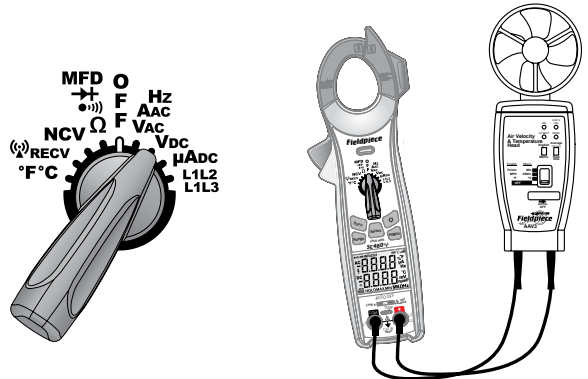

Visit [www.fieldpiece.com](http://www.fieldpiece.com) to see all of the different Accessory Heads that Fieldpiece offers.

## Wireless Receiver Mode

Use your SC460 to wirelessly receive live measurements from Fieldpiece wireless tools from anywhere on the jobsite. For example, receive an evaporator delta T measurement to your SC460 while you work at the condenser outdoor unit.

### Receiving Wireless Measurements

- 1 Select RECV (📶) switch position on SC460.
- 2 Press SYNC button for 1 second until meter beeps. Signal strength bars indicate wireless search.
- 3 Hold SYNC button for 1 second on the Fieldpiece wireless transmitter.
- 4 The wireless measurement, signal strength, and battery life of the wireless transmitter will display in the top-right corner of the SC460 screen.

Note: If a Fieldpiece wireless transmitter is not connected within 2 min, the SC460 will beep and stop searching.

## Wireless Auto-Connection

When powered on, SC460 will search for the last connected single-link wireless partner. If found, SC460 will automatically reconnect. If not found, wireless will stop searching after 2 minutes and an audible beep will sound.

## Log Measurements in Job Link™

Keep your hands free to focus on the job. Press the HOLD button on your clamp meter to log measurements within Job Link mobile app.

## Wireless Transmitter Mode

The SC460 is Fieldpiece Job Link™ compatible\*. Send electrical measurements wirelessly from SC460 to the Job Link™ mobile app via the JL2 Transmitter .

### Sending Wireless Measurements

- 1 Select any switch position other than RECV (📶) on SC460.
- 2 Press SYNC button for 1 second until meter beeps. Signal strength bars indicate wireless search.
- 3 Hold SYNC button for 1 second on the Fieldpiece JL2 Job Link™ Transmitter.
- 4 Follow instructions for Job Link™ mobile app.

## Wireless Specifications

**Wireless range:** Up to 75 feet (23m) line of sight

**Minimum wireless distance:** 1 foot (30cm)

**Wireless frequency:** 910MHz to 920MHz (US), 868.1MHz to 868.5MHz (European)

## Wireless Compatibility



**For Receiving Wireless Measurements:** EH4W, ET2W, LT17AW, SC57, SC660, SC460

**For Sending Wireless Measurements:** JL2 Job Link™ Transmitter, SC460 or SC660.



Job Link Note: Some electrical parameters may take up to 30 seconds to be visible within the Job Link Live measurements screen on your mobile device.

# Functions

## Auto Power Off

Auto power off or APO will automatically turn off your meter after 30 minutes of inactivity. By default it is activated and APO will show on the display. To disable, turn meter off. Hold  and power on the meter by turning the selector dial to any range. Release  after the beep. APO will no longer display over the battery icon.

## Hold/Max/min

Press  to cycle through Hold, Maximum, minimum, or real-time measurements. When MAXMIN is displayed, you are seeing the real-time measurement, but Max and min values are still being recorded. Press  for 1 second to clear and exit. Press  to log an SC460 measurement in Job Link mobile app. See Wireless Section for Job Link compatibility details.

## High Voltage Warning

The ⚡ symbol will display when measuring >30VAC/VDC. An audible beep will be heard and red LED will be shown.



## Battery Replacement

When your meter's battery is low, the battery icon will appear empty and blink for 30 seconds. "LO.b" will display and meter will power off.

Turn dial to OFF position, disconnect test leads and remove the battery cover with magnet strap on the back of your meter. Remove old battery and replace with a standard 9V battery only. Be sure to re-insert the magnet strap before re-installing the battery cover.

## Backlight Illumination

See your measurements in dark environments.

Press  to illuminate the display. Illumination will stay on for 5 minutes before turning off automatically. Illumination can be turned off at any time by pressing .

## Manual Ranging

Press  to disable auto-ranging and set your clamp meter to a specific range. Manual ranging applies to VAC, AAC, VDC, ADC, MFD, and resistance ( $\Omega$ ). Press for 1 second to exit manual ranging and return to auto-ranging.

# Safety Information

Never ground yourself when taking electrical measurements. Do not touch exposed metal pipes, outlets, fixtures, etc., which might be at ground potential, while taking measurements. Keep your body isolated from ground by using dry clothing, rubber shoes, rubber mats, or any approved insulating material.

Disconnect the test leads before opening the case. Inspect the test leads for damage to the insulation or exposed wire. Replace if suspect. Keep your fingers behind the finger guards on the probes while taking measurements.

When disconnecting from a circuit, disconnect the "RED" lead first, then the common "BLACK" lead. Use one handed testing when possible. Work with others.

Turn off power to the circuit under test before cutting, unsoldering, or breaking the circuit.

Do not measure resistance (ohms) when circuit is powered. Isolate load by disconnecting from circuit.

Disconnect the meter from circuit before turning any inductor off, including motors, transformers, and solenoids. High voltage transients can damage the meter beyond repair.

Do not use during electrical storms.

Do not apply more than rated voltages between input and ground.





Isolate capacitors from system and discharge them safely before testing.

Temperature switch prevents leaving thermocouple plugged in while measuring voltage.

When measuring high frequency AC current, do not exceed the rated 400AAC of the clamp. Failure to adhere may cause the clamp to heat up dangerously.

**All voltage tests:** All voltage ranges will withstand up to 600V. Do not apply more than 600VDC or AC rms.

Symbols used:

-  Caution, risk of electric shock
-  Caution, refer to manual.
-  Ground
-  Double insulation

## **WARNINGS**

DISCONNECT AND UNPLUG TEST LEADS before opening case.

TEST NCV FUNCTION ON KNOWN LIVE WIRE before using.

DO NOT APPLY VOLTAGE greater than 30VAC/VDC to the thermocouple or the jacks when the rotary dial is on °F°C. (Use only Type K thermocouples)

DO NOT APPLY VOLTAGE TO THE JACKS when the rotary dial is on microamps. Even low voltages can cause a current overload and potentially harm the meter.

# FCC Compliance and Advisory Statement

This device complies with Part 15 of the FCC rules. Operation is subject to the following two conditions: (1) this device may not cause harmful interference, and (2) this device must accept any interference received, including interference that may cause undesired operation.

This equipment has been tested and found to comply with the limits for a Class B digital device, according to Part 15 of the FCC rules. These limits are designed to provide reasonable protection against harmful interference in a residential installation. This equipment generates, uses and can radiate radio frequency energy and if not installed and used in accordance with the instructions, may cause harmful interference to radio communications. However, there is no guarantee that interference will not occur in a particular installation. If this equipment does cause harmful interference to radio or television reception, which can be determined by turning the equipment off and on, the user is encouraged to try to correct the interference by one or more of the following measures:

- 1.Reorient the receiving antenna.
  - 2.Increase the separation between the equipment and receiver.
  - 3.Connect the equipment into an outlet on a circuit different from that to which the receiver is connected.
  - 4.Consult the dealer or an experienced radio/TV technician for help.
- Shielded interface cables must be used in order to comply with emission limits.

**FCC Caution:** To assure continued compliance, any changes or modifications not expressly approved by the party responsible for compliance could void the user's authority to operate this equipment.

**Fieldpiece**  
Designed in USA  
MADE IN TAIWAN

# Limited Warranty

This meter is warranted against defects in material or workmanship for one year from date of purchase from an authorized Fieldpiece dealer. Fieldpiece will replace or repair the defective unit, at its option, subject to verification of the defect.

This warranty does not apply to defects resulting from abuse, neglect, accident, unauthorized repair, alteration, or unreasonable use of the instrument.

Any implied warranties arising from the sale of a Fieldpiece product, including but not limited to implied warranties of merchantability and fitness for a particular purpose, are limited to the above. Fieldpiece shall not be liable for loss of use of the instrument or other incidental or consequential damages, expenses, or economic loss, or for any claim of such damage, expenses, or economic loss.

State laws vary. The above limitations or exclusions may not apply to you.

# Obtaining Service

Email Fieldpiece warranty department at [fpwarranty@fieldpiece.com](mailto:fpwarranty@fieldpiece.com) for current fixed price repair service. Send check or money order made out to Fieldpiece Instruments for the amount quoted. If your meter is under warranty there will be no cost for the repair/replacement. Send your meter, freight prepaid, to Fieldpiece Instruments. Send proof of date and location of purchase for in-warranty service. The meter will be repaired or replaced, at the option of Fieldpiece, and returned via least cost transportation.

For international customers, warranty for products purchased outside of the U.S. should be handled through local distributors. Visit our website to find your local distributor.

© Fieldpiece Instruments, Inc 2016; v13