



GfG Instrumentation

Worldwide Manufacturer of Gas Detection Solutions

Transmitter Series

EC 28

Operation Manual



Contents

For Your Safety	3
Operating Information	3
General Description	4
Measuring Method	4
Transmitter Parts	5
Place of Transmitter Installation	6
Installation	7
Installing the Electrical Connections	7
Putting into Operation	8
Measuring Mode	9
Measuring Range Underflow	9
Measuring Range Overflow	9
Checking and AutoCal Adjustment of Zeropoint (ZERO)	11
Checking and AutoCal Adjustment of the Sensitivity (SPAN)	13
Service Menu and Extended Service Menu	14
Organisation of the Service Menu	16
Sensor Replacement	19
Transmission Properties	20
Indications and Messages	20
Indications of Special Conditions and Malfunctions	20
Indications in Measuring Mode	22
Indications in Service Mode and During Calibration	23
Conditions of Status LED's and Current Output	24
Priority of Indications and Messages in Measuring Mode	24
First Putting Into Operation and Maintenance	24
Service, Maintenance, Calibration and Adjustment	25
Regular Functional Checks	25
Repair	25
Fault – Cause – Remedy	25
Accessories	26
Connectors and Terminal Assignment	26
Measured gases and measuring ranges	27
Sensor specification	28
Internal Parameter Memory of the EC28	31
Technical Data – Part 1	32
Technical Data – Part 2	33
EC Type-Examination Certificate	34

For Your Safety

In accordance with Section 3 of the German Act on Technical Equipment, this Operating Manual draws attention to the intended use of the product and serves for the avoidance of danger. It must be read and observed by all persons who install, use, service, maintain or check this product. This product can only fulfil its tasks, i.e. its intended function, if it is installed, used, serviced, maintained and checked in accordance with the instructions of the manufacturer, i.e. GfG Gesellschaft für Gerätebau.

The warranty given by GfG is void if the product is not installed, used, serviced, maintained and checked in accordance with the instructions of GfG. The above does not affect the warranty and liability provisions in GfG's General Conditions of Sale and Delivery.

Operating Information

Gas detectors must be checked for correct functioning by a qualified person after the installation but before the start of the measuring operation (putting into operation) pursuant to national regulations. The applicable regulation for this in Germany is Section 56(2) of the German Accident Prevention Rules for Gas (UVV Gase [BGV B6 – previously VBG 61]).

The transmitter was checked for correct functioning and indication prior to delivery. The calibration was performed with suitable calibration gases. **This does not release the user from the obligation to perform a check with test gas when the transmitter is put into operation after the installation.**

The EC28 transmitter (and the derivatives mentioned below) is approved for use in explosion hazard zones and has an EC Type-Examination Certificate from 'EXAM BBG Prüf- und Zertifizier GmbH', in accordance with Directive 94/9/EC (ATEX100a).

Applicable for the EC28, EC28 D, EC28 DA, EC28 DAR, EC28 B, EC28 DB and EC28 DAB is:

Certificate: BVS 04 ATEX E 132 X

Marking:  II 2G EEx em [ib] IIC T4 -20°C≤Ta≤+50°C

Applicable for the EC28 i and EC28 Di is:

Certificate: BVS 04 ATEX E 132 X

Marking: II 1G EEx ia IIC T4 -20°C≤Ta≤+50°C



WARNING

The supply voltage must not exceed 30V DC! This also applies for voltage spikes!

General Description

A stationary gas detection system consists of a transmitter and an evaluation unit, i.e. GMA controller (not included in the scope of supply). The transmitter and the controller are interconnected with a telemetry cable. The transmitter converts the gas concentration into an electric measurement signal and transmits it via the telemetry cable for processing to the controller.

The EC28 D transmitter differs from the EC28 transmitter in that it has an additional display; the EC28 DA transmitter has both a display and a visual and audible alarm output.

The comprehensive electronics performs many tasks that make the operating and maintenance easier and significantly increase the operational reliability and measuring accuracy. The transmitter has the following features:

- Concentration indication on display or control unit
- Adjustments via push button or control unit without opening the enclosure
- Compensation of temperature influences
- Explosion protection in a temperature range of -20 to $+50^{\circ}\text{C}$
- Functional check in the temperature range (see sensor specification)
- Smart Sensor System – sensor replacement via plug-in, pre-calibrated sensors
- Permanent status display (operating/fault) on transmitter (not EC28 i)

Measuring Method

The sensors integrated in the EC28 transmitter are electrochemical measuring cells. Electrochemical measuring cells contain an electrolyte, a measuring electrode (anode), a counter electrode (cathode) and a reference electrode. The selection of the gas type to be monitored is effected by selecting the specific electrodes in combination with a suitable electrolyte. In this measuring method, an electric signal proportional to the pollutant combination is produced in the measuring cell. This electric signal is amplified in the EC28 and used for the indication or measurement value transmission. The measuring cells use the capillary diffusion barrier technology. The use of this method and an additional temperature compensation avoid a negative effect caused by fluctuating air pressure and temperature.

Transmitter Parts

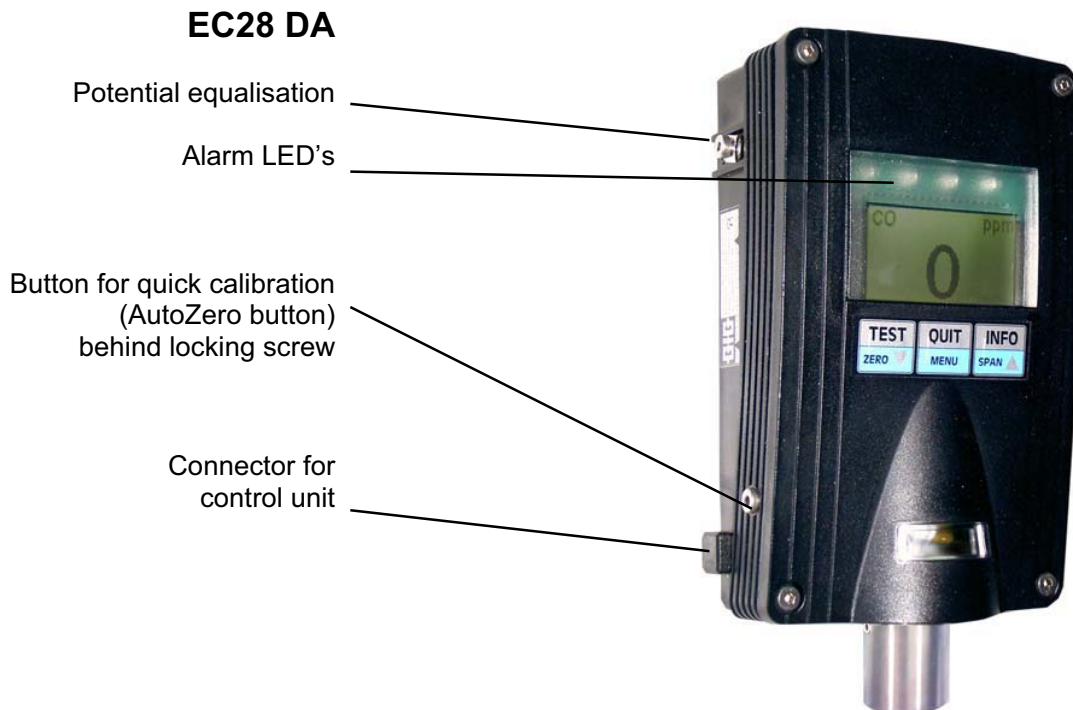
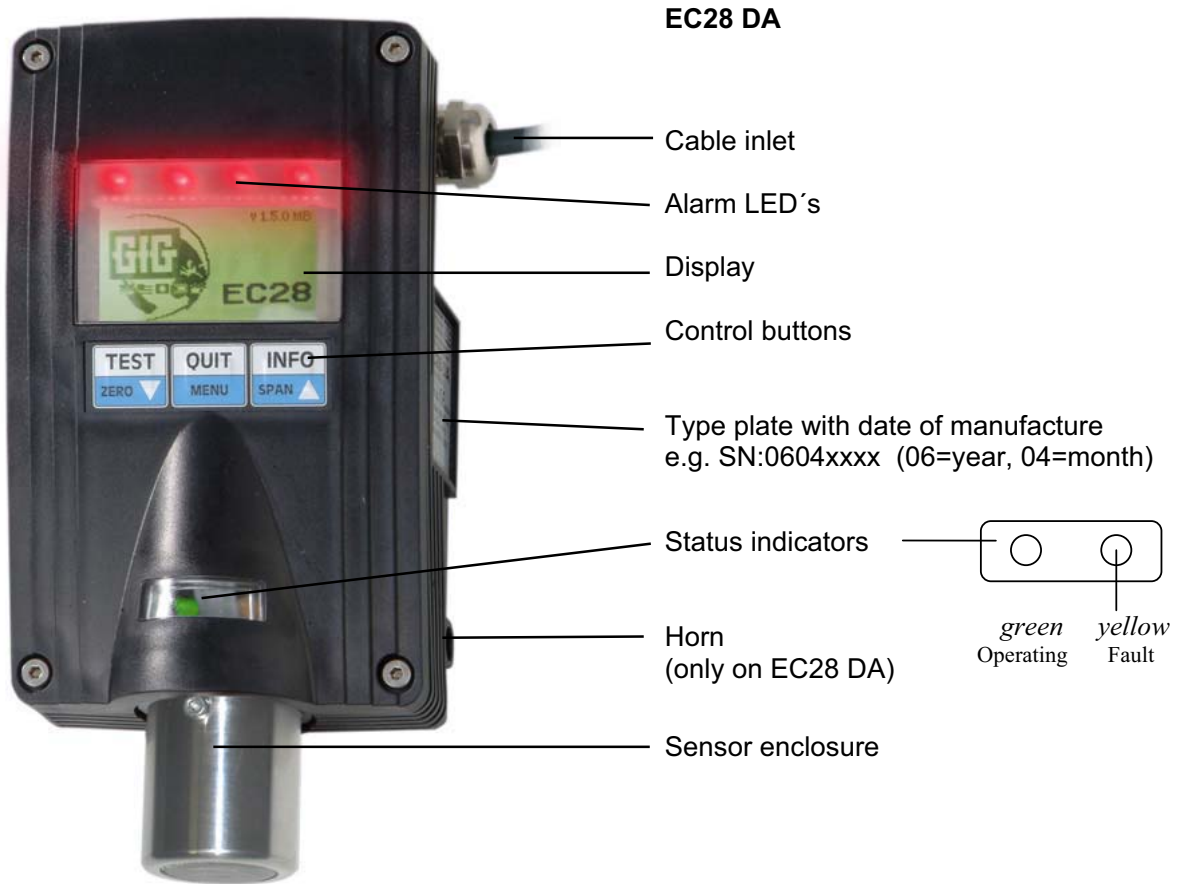

The transmitter type is shown on the type plate. The sensor enclosure contains the sensor and the sensor printed circuit board. The components for switching the sensor are mounted on the printed circuit board. The integrated display or the RC2 control unit are used for setting the electrical zeropoint and the indication sensitivity (calibration). A protected button for a quick zeropoint calibration is situated on the side of the transmitter. The electronics on the main pcb converts the measurement signal to a linear 4..20 mA measured value output signal.



Only the RC2 Control Unit (BVS 04 ATEX E 212) may be connected to the control unit connector of the transmitter for service work.

The RC2 control unit may be used in explosion hazard zones.

The buttons, functions and indications of the RC2 control unit are identical with those of the transmitter.



Place of Transmitter Installation



The enclosure was tested with an impact energy of 4 joules in accordance with EN 50014 Table 4 for Group II apparatus (lower level of the mechanical risk).

The enclosure of the transmitter types, EC28, EC28 D, EC28 DA, EC28 DAR, EC28 B, EC28 DB and EC28 DAB, must be protected against severe impact.

When selecting the place of installation it is important to exactly know and take into account the environmental conditions. The ventilation conditions must be taken into account in order to achieve representative measurement results.

The transmitter must be installed at a place where the gases can reach the sensor even with unfavourable ventilation. A 'selective' measuring with, for example, smoke pipes, should be done if necessary. An air flow to the transmitter from the bottom (sensor end) should be generally avoided.

The following external influences should also be taken into account

- rainwater, water splashes and drops, condensate
- the dust level in the atmosphere

The transmitter is largely protected against ingress of water and dust (IP 64).

Special accessories can be used to protect the transmitter from damage in the case of very difficult measuring conditions. GfG will be pleased to advise you about suitable measures.



The warranty can be voided if the sensor is exposed to environmental conditions that were unknown to GfG during the planning or supply.

Installation

When selecting the place of installation, take into account that the transmitter must be accessible for service and calibration work. The transmitter must be installed vertically with the sensor pointing downwards.

The transmitter must be connected to the controller in accordance with the terminal diagram (see *Connectors and Terminal Assignment*). Four special screws must be screwed out and the enclosure lid removed for the mounting. The enclosure is affixed with two screws.

The enclosure contains the printed circuit board encapsulated in potting compound (encapsulation 'm'). The terminal space (inherently safe 'i' for EC28 i and EC28 Di; increased safety 'e' for all other transmitter types) for the connection of the controller is situated in the upper area in front of the pcb.

Installing the Electrical Connections

The cable laying and the connection of the electrical installation may only be performed by qualified persons and in accordance with the applicable regulations. The electrical connection must be made with a screened cable (e.g. LIYCY 3 x 0.75 mm²). The core cross-section is dependent on the length of the connecting cable and the transmitter type. Cables with a core cross-section of 0.75mm² may be used for short distances of up to 500m (200m for EC28 DA...). The core cross-section must be 1.5mm² for longer distances. The cable length must not exceed 1000m.

The screen must be connected in the M16x1.5 cable gland. A potential equalisation must be installed if the transmitter is affixed to an electrically conducting mount (e.g. steel beam). Only the transmitter may be installed in an explosion hazard zone – the controller and the power supply must be installed outside such zone.



The electrical installation of the transmitter must be effected so that the connecting wires are directly routed from the cable inlet to the terminals! The connecting cable must not come in contact with other internal electrical circuits.



The installation of the transmitter may only be performed in the absence of gas. The Transmitter may only be opened when the electrical power is switched off.

If the transmitter is not operated with the GMA controller, the operating voltage of its power supply must not exceed 30V DC.

The lid of the enclosure must be sealed and screwed tight again after the electrical installation.



The user must ensure that the voltage at the terminals of the transmitter can never exceed the maximum fault voltage V_m shown on the type plate even in a fault condition.

V_m is 250V AC or 45V DC depending on the transmitter type.

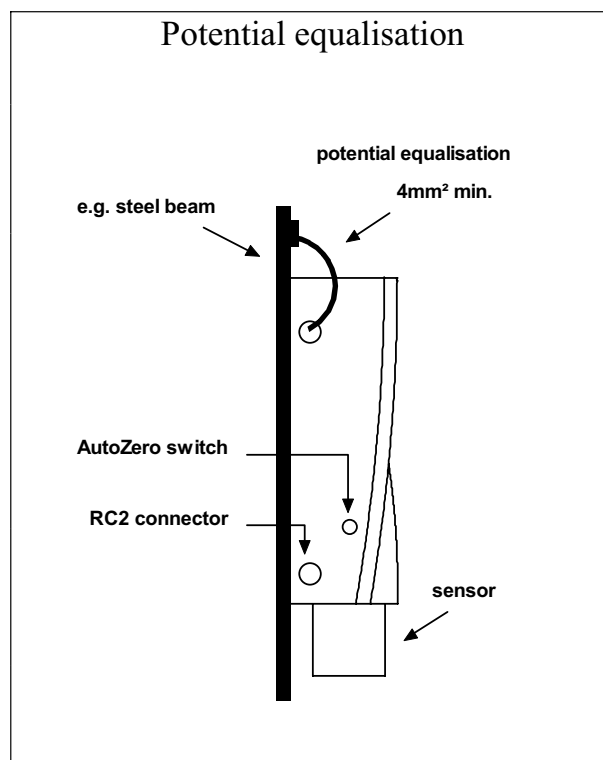
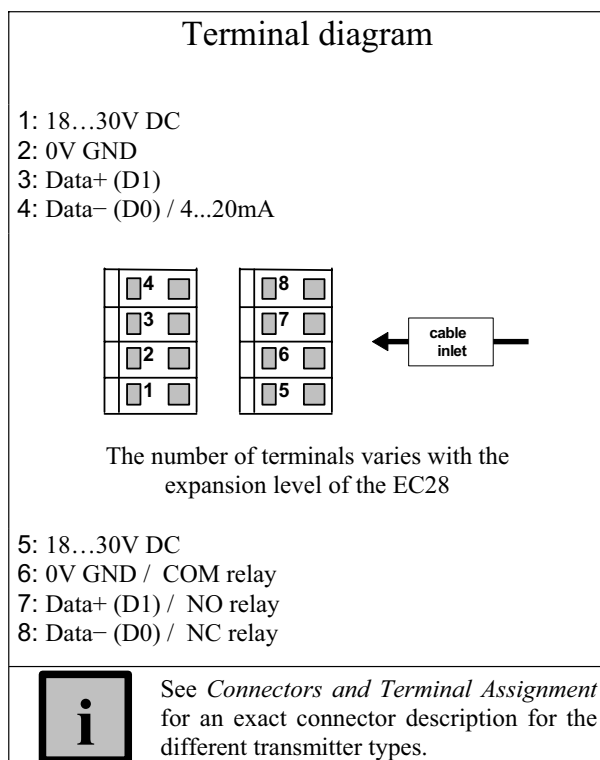

Putting into Operation

The EC28 transmitter is tested for correct functioning and indication prior to delivery. The calibration is done with suitable test gases. However deviations can arise under certain transport, installation or environmental conditions.

The gas detection system must therefore be put into operation and checked for correct functioning by a person authorised by the manufacturer or a qualified person.

The gas detection system needs a few minutes after the switch-on for:

- the self-test, which consists of a program and working memory test,
- reading and evaluation of the transmitter parameters with concurrent memory test
- reading and evaluation of the sensor parameters with concurrent memory test
- sensor warm-up

The memory tests are performed during the first few seconds of the switch-on phase. The current interface output level is 0mA and the yellow and green LED's are lit during this time. After the memory tests, the current interface output level changes to 1.6mA and the Fault LED is lit and the Operating LED blinks slowly. The *Reading transm. param. / Load.* message initially appears in the display. Transmitters with a display (or the RC2 control unit) sequentially display measuring unit, gas type, measuring range, alarm limit values and the calibration gas concentration.

The EC28 switches automatically to the measuring mode after a sensor warm-up phase – a countdown in seconds appears in the display.

The transmitter switches to the fault mode if a transmitter fault/error is detected during the start phase. The current interface outputs 1.2mA and a fault/error message is shown in the display (see *Indications of Special Conditions and Malfunctions*). The Fault LED is permanently lit. The display light blinks in the display variants.

Notes:

The first putting into operation always requires an adjustment of the zeropoint (*AutoCal ZERO*) after its warm-up time and subsequently a sensitivity check or calibration (*AutoCal SPAN*).

Measuring Mode

In measuring mode, the digital display shows the current gas concentration.

The display readout of the measurement value is always identical with the readout on the connected RC2 control unit!

The measuring of the gas concentration is performed continuously. Sensor signals that exceed the limit value are immediately detected by the EC28 (with Alarm function) and, if applicable, indicated visually. Functions of the electronics, like parameter memory or the sensor, are continuously monitored. The green Operating LED is lit and the yellow Fault LED is off in the faultless measuring mode.



As a ready signal to show that the EC28 is in the measuring mode, the display indication on the RC2 control unit and on the EC28 Di changes from the gas concentration to the gas unit and gas type for a short period at minute intervals.

On the EC28 with graphic display, a pending measurement value (>0) is displayed as a bar graph which always shows the current measurement value in addition to the numeric value (short display of measured gas and measuring unit every 30 seconds). The measured gas and the measuring unit is always displayed additionally in the absence of a measurement signal.

Measuring Range Underflow

Measurement values below the zeropoint are displayed as a numerical value with a negative sign. The current interface outputs a signal, corresponding to the measurement value, in the range of 2.8...4.0mA.

If the measurement value is less than -7.5% of the measuring range, the Fault LED will be permanently lit and the display indication will alternate between the negative measurement value and $\downarrow\downarrow\downarrow/----$. The current interface permanently outputs 2.8mA.

If the measurement signal is less than the measuring range of the transmitter electronics, the display permanently shows $\downarrow\downarrow\downarrow/----$ and the current interface outputs 1.2mA.

Measuring Range Overflow

A measuring range overflow between 100% and 112.0% of the measuring range is shown in the display by $\uparrow\uparrow\uparrow/----$ alternating with the measurement value. The current interface outputs a signal, corresponding to the measurement value, in the range of 20...22mA.

If the measurement value exceeds 112.0% of the measuring range, the display will show a blinking $\uparrow\uparrow\uparrow/----$. The current interface outputs 22mA.

If the measurement signal exceeds the measuring range of the transmitter electronics, the Fault LED will be permanently lit, the display permanently shows $\uparrow\uparrow\uparrow/----$ and the current interface outputs 22mA.

Control buttons

The functions of the buttons on the transmitter and on the RC2 control unit are always identical. The display output of the EC28 Di is also identical with that of the RC2 control unit.

Display, LED and Horn Tests

A display/LED test is started if the  button is briefly pressed in the measuring mode. All LED's and all elements of the display are then lit for two seconds. On the EC28 DA, the Alarm LED's are also briefly lit and the horn is also briefly activated.

Display of Operating Parameters

A brief pressing of the  button during the measuring mode will cause an automatic sequential display of the following main operating parameters.



- Measured gas ¹
- Measuring unit ¹
- Measuring range ¹
- Calibration gas concentration ¹
- Alarm 1 limit value ^{1 2}
- Alarm 2 limit value ^{1 2}
- Mean value of the last logged 8 hours
- Mean value of the last logged 15 minutes



¹ Also displayed during the switch-on phase

² Only displayed with alarm function

Example of a display sequence for the RC2 control unit with 7-segment display on an EC28 DA transmitter:
UOL H2 SCAL 4.0 CGAS 1.0 R 10.2 R2 0.4 LUR 0.3 SEEL 0.1

Measurement Value Histogram

An alternative display mode can be selected if a graphic display is used. After the display of the operating parameters was activated with the  button, a second brief pressing of the  button will cause a histogram selection menu to appear.

Data for the last 24 hours, 8 hours and 2 hours can be viewed (selected by pressing the corresponding marked button). Selecting a time period will cause a switch to the histogram display mode. You can then switch between the display of the average values, maximum values or minimum values by briefly pressing the  or the  button.

In the display area where the measurement value is normally shown, previous measurement values are now displayed in the form of a histogram. The current pending measurement value is additionally displayed in the upper area together with gas type and gas unit. The histogram is continuously updated and can be used as a permanent display mode.

This display mode is terminated if the  button is briefly pressed or if a special message (e.g. alarm activation) appears.

Limit Value Alarm

The EC28 has two limit value alarms (if supported by transmitter). An alarm is activated as soon as the gas concentration exceeds (or falls below) the respective alarm limit value (setting via the service menu). The EC28 displays the limit value alarms via the LED row above the display, the display backlight and a horn. When the gas concentration exceeds or falls below the first alarm limit value (Alarm 1), the display light and

the LED row are continuously activated in slow alternation. The display shows the current measurement value alternating with *Alarm 1/R1*.

When the gas concentration exceeds or falls below the second alarm limit value (Alarm 2), the display light, the LED row and also the horn are activated in quick alternation. The display shows the current measurement value alternating with *Alarm 2/R2*.

The resetting of the limit value alarms can be effected automatically or manually, i.e. with or without self-holding, depending on the function setting in the service menu.

The function of the horn is fixed and not changeable: activation with alarm 2, automatic switch-off when the measurement value exceeds or falls below the second alarm limit value, always resettable with .

A self-holding alarm cannot be reset by pressing the  button until the measurement value has fallen below the alarm limit value.

Depending on the settings in the service menu (see according chapter) the relay (EC28 DAR only) is activated by alarm release.

Sensor Life

Electrochemical sensors have a limited life. The anticipated life of the sensors used in the EC28 is 1-3 years depending on the use conditions. The transmitter gives a warning that the sensor must be replaced during the next maintenance some months before the end of the service life of the sensor. The warning is given by a regular brief blinking of the Fault LED and the display of the *Sensor replacement/ [HnG 5En5]* warning in alternation with the measurement value. If the sensor is not replaced within the next few months, the transmitter will switch off the measuring mode when the sensor life has expired (*Sensor life expired / [HnG 5En5]*). The current interface outputs 1.2mA, the yellow Fault LED goes on and the green Operating LED briefly blinks once at intervals.

Transmitter Fault

If a transmitters fault is detected, the yellow Fault LED goes permanently ON, the current interface outputs 1.2mA and a fault/error message appears in the display (see *Indications of Special Conditions and Malfunctions*).

A fault exists if, for example

- The sensor or the electronics in the transmitter is defective
- Faults are detected during the self-monitoring of the transmitter
- A sensor is not plugged in

See *Indications of Special Conditions and Malfunctions* for further causes.

The yellow Fault LED goes off as soon as the fault is corrected.

Checking and AutoCal Adjustment of Zeropoint (ZERO)

A precondition for this check in the case of TOX/NOX sensors is atmospheric air without disturbing gas constituents. Synthetic air can be used instead for the adjustment in polluted atmospheres. 100% by vol. N₂ must be used for the check/adjustment in the case of an oxygen sensor.

A calibration adapter can be attached to the sensor enclosure for the checking/adjustment. The sensor can be fed with the synthetic air (or 100 % by vol. N₂) pressureless at a flow rate of approx. 0.5 l/min. via this calibration adapter.

A zeropoint calibration is necessary if the indication deviates from zero in measuring mode. A new zeroing is also necessary after a change in the measured gas or sensor replacement.

The adjustment of the zeropoint can be performed with the AutoCal program if the displayed value remains constant. The AutoCal program performs an automatic adjustment of the zero signal.

Activation

An automatic zeropoint calibration, via the AutoZero button or the normal access code `0011` is only possible when the currently displayed value does not exceed 10% of the maximum measuring range.

On a transmitter without display, the operator cannot ascertain (before the pressing of the AutoZero button) if the measurement value is within the permitted tolerance range for a zero calibration (i.e. < 10% of the maximum measuring range). The transmitter will remain in the measuring mode if the measurement value exceeded 10% of the maximum measuring range when the AutoZero button was pressed. This is noticeable because the Fault LED remains OFF. In this case, the zeropoint adjustment can only be performed with the control unit.

A competent operator can activate, with the access code 0055, the zeropoint calibration if the indication does not exceed 15% of the maximum measuring range. This access code should only be used by trained safety personnel of the user.

If the current zeropoint indication has exceeded a value corresponding to 15% of the maximum measuring range and it has been confirmed that the indication was not caused by the presence of gas, a temporary zero code (valid for a maximum of hour) can be read in the *Info/Info* submenu of the service menu (*Zero Code/Code*), with which the zeropoint adjustment can be activated without restrictions.

Note:





The necessity for the last action can be an indication that the sensor is defective and therefore needs to be replaced as quickly as possible.

The access code limits (10%/15%) are not applicable for operation with an oxygen sensor.

Procedure

The quick calibration is activated by pressing the protected AutoZero button (on the side of the enclosure) for at least 3 seconds after the screw over the button has been removed. The current interface will then output 2.0mA, the Fault LED will flash slowly and step 3 of the following description will be automatically activated.

The procedure with the keypad on the display or on the RC2 control unit is as follows:

1. Activation by a long pressing (at least 3 seconds) of the  button. After the activation, the current interface outputs 2.0mA during the entire operation and the Fault LED flashes slowly. *Code/Code* appears in the display.
2. The numeric access code, `0011` or `0055` must now be entered. The digit at the current position can be changed with the  and  buttons and confirmed with the  button. A long pressing of the  button deletes the last confirmed digit.
3. After correct entry, the display shows the current measurement value in alternation with *Zero/Zero*. The new zeropoint is set if the measurement value remains constant for a defined time (for oxygen sensors: after a recognized reduction of concentration and a fixed waiting time of 2 minutes). The AutoCal program is then automatically terminated with the *Save/Save* message and the transmitter switches back to the measuring mode.
In the case of oxygen sensors, the *Finished/End* message is also shown to signal that the nitrogen feed should be stopped. The transmitter waits for a measurement value increase before switching back to the measuring mode.

Note:

If the current measurement value is outside the permitted limit for the respective access code, the *Code invalid/FRL* message will appear briefly during step 3 and the transmitter will switch back to the measuring mode.

The AutoCal program can be shortened to a constant measurement value during the check by a long pressing of the  button or the AutoZero button. The hardware then start directly with the zeropoint adjustment.

The AutoCal program can be terminated without zeropoint adjustment during the waiting time by a short pressing of the  button or the AutoZero button. *Quit/E5C* appears briefly in the display.



The screw (with the seal) must be screwed in again until the end stop is reached after the quick calibration with the AutoZero button on the side of the enclosure!

The following fault messages can appear during the zeropoint adjustment:

Display indication	Comment	Fault LED
<i>Cal. error no. 2/FRL Err.2</i>	The gas signal is unstable	Quick blinking
<i>Cal. error no. 3/FRL Err.3</i>	The zeropoint is outside the permitted tolerance range	

All fault messages must be acknowledged with the  button or the AutoZero button on the side of the enclosure. The transmitter switches back to the measuring mode with the unchanged zeropoint setting after the acknowledgement.

Checking and AutoCal Adjustment of the Sensitivity (SPAN)

The RC2 control unit is required for a calibration in the case of a transmitter without display.

The set calibration gas concentration should be checked first by a short pressing of the  button. The value of the test gas concentration should be at least 20% of the measuring range above the main alarm (i.e. the alarm 2 threshold).







Special safety precautions must be observed if there is a toxic gas exposure hazard. Maximum Workplace Concentration values are guiding values for toxic gas hazard.

A calibration adapter must be attached to the sensor enclosure for the checking/adjustment of the readout sensitivity. The sensor is then fed, via the calibration adapter, with the test/calibration gas (fresh air or synthetic air in the case of an oxygen sensor) pressureless at a flow rate of approx. 0.5 l/min. The readout on the display is monitored. A sensitivity adjustment is necessary if the displayed value differs from the test/calibration gas concentration. The sensitivity adjustment can be done with the AutoCal program if the displayed value remains constant. The AutoCal program performs an automatic adjustment of the measurement signal to the calibration gas.





The sensor must be free of calibration gas (zero reading) before each readjustment.

The procedure with the keypad on the display or on the RC2 control unit is as follows:

1. Activation by a long pressing (at least 3 seconds) of the  button. After the activation, the current interface outputs 2.0mA during the entire operation and the Fault LED flashes slowly. *Code / Code* appears in the display.
2. The numeric access code, 0011 must now be entered. The digit at the current position can be changed with the  and  buttons and confirmed with the  button. A long pressing of the  button deletes the last confirmed digit.
3. After correct entry, the display shows the current measurement value in alternation with *Span / SPAN*. The transmitter now waits for a noticeable concentration increase. The measurement value is used for updating the sensitivity if the measurement value remains constant for a defined time (after a fixed waiting time of 2 minutes). The *Save / SAVE* message is then displayed. The adjustment data has then been automatically updated. However, the transmitter does not immediately switch back to the measuring mode because the still present calibration gas concentration would otherwise activate the alarms. The transmitter waits in the adjustment mode until it detects a reduction in the gas concentration and then a stabilisation of the displayed value. The display shows *Zero / Zero* in alternation with the current measurement value. The transmitter switches back to the measuring mode after the stabilisation. If a gas reduction and stabilisation of the measurement value is not detected, the transmitter automatically switches back to the measuring mode after 3 minutes.

Note:

The AutoCal program can be shortened in each phase by a long pressing of the  button. *Save / SAVE* will appear briefly in the display and the measurement value will be stored directly for an update of the sensitivity.

Press the  button only briefly in order to terminate the AutoCal program without sensitivity adjustment. *Quit / ESC* will appear briefly in the display.

The following fault messages can appear during the sensitivity adjustment:

Display indication	Comment	Fault LED
<i>Cal. error no. 1 / CAL Err.1</i>	A calibration gas increase was not detected	Quick blinking
<i>Cal. error no. 2 / CAL Err.2</i>	The gas signal is unstable	
<i>Cal. error no. 3 / CAL Err.3</i>	The gas signal is outside the permitted tolerance range	

The fault messages must be acknowledged with the  button. The transmitter switches to the measuring mode without a new adjustment. The adjustment must be repeated.

Service Menu and Extended Service Menu

Service Menu Activation

The service menu allows you to view and change all important parameters of the EC28. The measuring mode is interrupted when the service menu is selected, the transmitter switches to service mode, no alarms are activated. The ‘Service’ special condition is signalled by a slow blinking of the Fault LED and a current output signal of 2.4mA. The transmitter automatically exits the service mode and switches back to the measuring mode if the operator does not press a key for one minute.



All the parameter changes made in the service menu relate to the currently selected gas type!







If the gas type and parameters are to be changed, you must first select the new gas type before the parameter changes can be effective for this gas type.

The service menu can be called up in two different expansion levels.



The standard service menu is called up with the access code *1100*. No important settings, e.g. measured gas or measuring range limit value, can be changed. Attempts to change such settings are ignored and commented with the *Barred/FR iL* message.

The extended service menu is called up with the access code *5050*. All settings can be changed without restriction in the extended service menu. This access code should only be used by specially trained safety personnel of the user.



The procedure with the keypad on the display or with the RC2 control unit is as follows:

1. Press the  button for at least 3 seconds. The transmitter then switches to the service mode. The prompt *Code/Code* will appear in the display.
2. The numeric access code *1100* or *5050* must now be entered. The digit at the current position can be changed with the  and  buttons and confirmed with the  button. A long pressing of the  button deletes the last confirmed digit.
3. After correct entry, you automatically jump back to the service menu at the *Gas/GAS* menu item. You can then select the other menu items with the  and  buttons.

Operating

The selection of a menu is done with the  and  buttons.

The activation of the desired menu/submenu item after its selection is done by briefly pressing the  button.

The parameter change or the selection of a submenu is done with the  and  buttons.

The confirmation of a parameter is done by briefly pressing the  button.

The service menu can be exited with or without a saving of the parameter changes.

Note:

Several parameters can be changed without having to leave the service menu between the changes in order to save the change. A save operation at the end of the settings saves all parameters previously changed in the service menu.

Exceptions: When the gas type is changed, the change is immediately saved after the confirmation of the menu item and the parameters for this gas type are then activated → the EC28 restarts. Date and time settings are immediately saved.

Some parameters are related. A parameter change can therefore result in an automatic adjustment of other parameters.

Organisation of the Service Menu

Service Menu									
Quit	Save	Gas ^{0 1}	Measuring range ¹	Cal. gas	Alarm ²	Relay ³	Zero range ⁵	Info	Language/Time/Bus
ESC	SAVE	GRS 01	SCAL 1	CGAS	AL 2	REL 3	BRND 5	INFO	LARC
Exit service menu without saving all (changed) parameters	Exit service menu after saving all (changed) parameters	Measured gas selection	Measuring range limit value	Calibration gas concentration	Submenu	Submenu	Switch on/off sensor zero range	Display transmit ter info	Submenu

Alarm			
Return	Alarm 1	Alarm 2	A1 hys.
ESC	A1	A2	H1
Exit submenu	Alarm 1 limit value	Alarm 2 limit value	Alarm 1 switch-off hysteresis
			Alarm 2 switch-off hysteresis
			Alarm 1 function
			Alarm 2 function

Relay		
Return	Relay func. ¹	Relay mode ¹⁴
ESC	FUN 1	REL 14
Exit submenu	Relay function	(Alarm-)relay mode
		Test
		TEST
		Test activation of the relay contacts

Language/Time/Bus		
Return	Language	Time ^{6 7}
ESC	LARC	CLOC 67
Exit submenu	Language of display text	Current date and time
		Modbus slave addr. ¹⁶
		b.ADD 16
		Modbus slave address
		Modbus com.param. ¹⁶
		b.COM 16
		Modbus interface parameter

⁰ Menu item entry

¹ Only changeable in extended service menu

² Only visible on an EC28 with alarm functionality

³ Only visible on an EC28 with relay functionality

⁴ Visibility dependent on *Relay func.*

⁵ Sensor predetermines size of range

⁶ Only settable if supported by transmitter

⁷ Only settable if RC2 not connected

Additional Menu Explanations

Quit

Exit service menu without saving entered parameter changes.

Save

Exit service menu after saving all entered parameter changes.

Gas

This function allows you to explicitly select a gas type and the parameters stored in the sensor. Only the gases for which the sensor is intended and for which the sensor is parameterised will be displayed.

Note:

The EC28 automatically performs a restart if a gas type change is confirmed.

A gas type change always requires a zeropoint calibration (*AutoCal ZERO*) after its warm-up time and then a sensitivity check and, if necessary, a calibration (*AutoCal SPAN*).

There are no restrictions for the first zeropoint adjustment after a gas change.

The parameters, e.g. measuring range, calibration gas concentration and alarm limit values should be checked and, if necessary, adjusted, after a gas change.

Measuring range

The measuring range limit value can be set in absolute steps of ...100, 150, 200, 250, 300, 400, 500, 750, 1000... but not smaller than $\frac{1}{6}$ of the maximum measuring range limit value.

Note:

A change in the measuring range is primarily a conversion of the current output. The standardised output signal of 4...20mA is used for the new measuring range. The numerical indication in the display is not changed by this.

The alarm limit values must be checked and, if necessary adjusted after a reduction in the measuring range. If alarm limit values were set to a higher value than the new measuring range limit value they will automatically be set to the current measuring range limit value.

Cal. gas

The calibration gas concentration setting must correspond with the concentration of the used calibration gas. The calibration gas concentration can be set in the range of 10%–105% of the current measuring range limit value.

Zero range

The zero range of the sensor can be deactivated if necessary → the true measured value about the zeropoint will also be displayed.

Possible settings:

- Zero range activated (On/ON)
- Zero range deactivated (Off/OFF)

Info

Callable/displayed transmitter information:

- Sensor type/MK number (*Sensor type*/5.tYP)
- Sensor serial number (*Sensor no.*/5.nr)
- Software version (*Software ver.*/5.nr)
- Transmitter serial number (*Man. no.*/F.nr⁻ F.nr₋)
- Zero code (*ZERO Code*/EodE)

Note:

The number shown under *ZERO Code*/EodE is an access code that is valid for a limited period of time and can be used to activate the zeropoint adjustment without restrictions (see *AutoCal ZERO*).

The info items are automatically displayed once in sequence in the case of a connected RC2 or no graphic display – you otherwise proceed with the  button.

Alarm → Alarm 1 and

Alarm → Alarm 2

This alarm is activated when its alarm limit value is reached.

The maximum value of the alarm limit values is the current measuring range limit value. However Alarm 1 cannot be set greater than Alarm 2 in the case of a ‘greater than’ alarm and Alarm 1 cannot be set smaller than Alarm 2 in the case of a ‘less than’ alarm. For example, in the case of a greater than alarm, Alarm 2 can only be set to nought if Alarm 1 was previously set to nought.

An alarm is deactivated if its limit value is set to nought.

Note:

The horn in the EC28 is also activated if Alarm 2 is activated.

Alarm → A1 hys. and

Alarm → A2 hys.

The hysteresis describes the difference between the switch-on and switch-off point of the alarm limit values.

A value greater than nought delays the alarm switch-off by this value with respect to the alarm limit value that sets the alarm.

The maximum settable hysteresis is limited to 5% of the maximum measuring range limit value. Furthermore, it cannot be greater than the alarm limit value in the case of a ‘greater than’ alarm or in the case of a ‘less than’ alarm, the current measuring range limit value less the alarm limit value.

Alarm → A1 func. und

Alarm → A2 func.

Possible function settings for Alarm 1 and Alarm 2 are:

- Alarm on ‘less than’, storing alarm, manually resettable after alarm activation
(*Under-stor.-reset/L 5*)
- Alarm on ‘less than’, non-storing alarm, not manually resettable
(*Under-n.stor.-n.reset/L n5*)
- Alarm on ‘greater than’, non-storing alarm, not manually resettable
(*Above-n.stor.-reset/H n5*)
- Alarm on ‘greater than’, storing alarm, manually resettable after alarm activation
(*Above-stor.-reset/H 5*)

Note:

The function of the horn on the EC28 is fixed to: ‘Alarm on ‘less than’ or ‘greater than’ limit value of Alarm 2, non-storing alarm, manually resettable even with existing alarm conditions“

Relay → Relay func.

Possible function settings for the relay are:

- Tripping during the calibration (*AutoCal SPAN*) for calibration gas feed
(*Cal. pump/PUFP*)
- Continuous tripping on Alarm 1 (*Alarm 1/.R 1*)
- Continuous tripping on Alarm 2 (*Alarm 2/.R 2*)
- Alternating tripping (interval) on Alarm 1 and continuous tripping on Alarm 2
(*Alarm 2 + 1 Int. / R 2. 1*)

Relay → Relay mode

Possible operating mode settings for the alarm relay:

- Normally closed mode (*N-closed/n.c.*)
- Normally open mode (*N-open/n.o.*)

Relay → Test

The relay is tripped twice briefly.

Language/Time/Bus → Language

Possible language settings:

- German (*Deutsch* / dEʊ)
- English (*English* / Eŋɪ)
- Spanish (*Espanol* / 5PR)

Note:

The language setting mainly affects the visualisation in the graphic display.

Language/Time/Bus → Time

Setting sequence: year, month, day, hours, minutes

Language/Time/Bus → Modbus slave addr.

Setting range: 1–247

Note:

See also separate ‘EC28 – MODBUS Implementation’ document.

Language/Time/Bus → Modbus com. param.

Possible interface settings:

- 19200 Baud, 8 data bits, no parity, 2 stop bits (19200, 8N2 / ~ 8n2)
- 19200 Baud, 8 data bits, even parity, 1 stop bit (19200, 8E1 / ~ 8E 1)
- 9600 Baud, 8 data bits , no parity, 2 stop bits (9600, 8N2 / _ 8n2)
- 9600 Baud, 8 data bits , even parity, 1 stop bit (9600, 8E1 / _ 8E 1)

Note:

See also separate ‘EC28 – MODBUS Implementation’ document’.

Sensor Replacement

The GfG sensors are equipped with a non-volatile memory in which the sensor data (serial number etc.), the calibration data and the selectable gas types are stored.

To replace the sensor, you must undo the Allen screw on the side of the sensor enclosure (see *Transmitter Parts*) and carefully pull off downwards the sensor enclosure. The sensor must also be pulled off downwards and the new sensor then carefully plugged in. The plug-in connector has a misalignment protection – the sensor can only be plugged-in in one orientation. The sensor enclosure must be mounted again correctly and then fixed with the screw.

After removal of the sensor, the display, the status LED and the current output (depending on transmitter variant) signal a **Sensor error no. 1/5Eŋ5 Err. 1** (see *Indications of Special Conditions and Malfunctions*). The EC28 performs a restart after the new sensor has been installed (See *Putting Into Operation* for sequence and information).

Fault message Confirm gas change / EHEE GAS

If the new sensor is not specified for the gas type set (as the measured gas) on the transmitter this will be detected during the transmitter powerup. This will be signalled in the display and the green LED will give a double blink (2x short blinks). The EC28 does not switch to the measuring mode.

Pressing the  button for at least 3 seconds and then entering 5050 will take you to the (extended) service menu where you can change the menu item, *Gas / GAS*, to a measured gas that is supported by the sensor (see *Service menu → Changing the measured gas*).

Fault message *Confirm measuring range/CHEC 5CAL*

If the measuring range setting in the new sensor differs from that in the old sensor, this will be detected during the transmitter powerup. This will be signalled in the display and the green LED will give a double blink (2x short blinks). The EC28 does not switch to the measuring mode.

Pressing the  button for at least 3 seconds and then entering 5050 or 1100 will take you to the service menu where you can check, and if necessary change, the measuring range with the menu item, *Measuring range/5CAL* (see *Service menu*→*Setting the measuring range limit value*). You must then exit the service menu via the menu item, *Save/SAVE*.

Note:

The installation of a new sensor always requires a zeropoint calibration (*AutoCal ZERO*) after its warm-up time and then a sensitivity check and, if necessary an adjustment (*AutoCal SPAN*).

There are no restrictions for the first zeropoint calibration after a sensor replacement.

Transmission Properties

The transmitter has different transmission properties depending on the measured gas type. The warm-up times can differ depending on the measured gas. The signal output is always proportional to the gas concentration.

Indications and Messages



The indication of special conditions via the current interface (<2.8mA) is not possible in the case of the EC28 i or EC28Di. The current output during these special conditions has a minimum value of 2.8mA.

Indications of Special Conditions and Malfunctions

The following table contains descriptions of the special conditions for which the yellow Fault LED is permanently lit (exceptions: EC28 i and EC28 Di) and the current interface outputs $\leq 1.6\text{mA}$. In the case of a transmitter without display, the following fault messages should be displayed with the RC2 control unit for better diagnosis or the exact value of the current output should be evaluated.



No.	Indication	Green LED	Yellow LED	Current output	Cause	Note/Explanation
001	<i>Self-test</i> ----- EEE	ON	ON	0mA	Program and memory tests at start of system powerup	
002	<i>Reading transmitter parameters</i> Operating parameters ----- L o R d Operating parameters	Blinks	ON	1.6mA	System powerup (during start after measured gas or sensor change)	Switches automatically to the sensor warm-up phase
003	<i>Sensor warm-up</i> Seconds countdown ----- Seconds countdown	Blinks	ON	1.6mA	Sensor warm-up phase	Switches automatically to the measuring mode after completion

No.	Indication	Green LED	Yellow LED	Current output	Cause	Note/Explanation
101	<i>Sensor life exceeded</i> [HnG SEr5]	Single pulses	ON	1.2mA	Sensor life expired	Sensor must be replaced
102	<i>Confirm gas change</i> [HEC GAS]	Double pulses	ON	1.2mA	Sensor is not specified for the measured gas (after sensor replacement)	Replace sensor again or select other measured gas (see <i>Sensor Replacement</i>)
103	<i>Confirm measuring range</i> [HEC SCAL]	Double pulses	ON	1.2mA	Measuring range setting of sensor and transmitter do not correspond for selected measured gas (after sensor replacement)	Check SCAL measuring range and change if necessary (see <i>Sensor Replacement</i>)
104	<i>System error (Working memory defective)</i> 545 Err.1	OFF	ON	1.2mA	Error during RAM access	Restart transmitter. Replace transmitter if error message is repeated
105	<i>System error (Prog. memory defective)</i> 545 Err.2	OFF	ON	1.2mA	Error during ROM access	
106	<i>System error (Param. memory defective)</i> 545 Err.3	OFF	ON	1.2mA	Error during EEPROM access (internal)	
107	<i>System error (Temperature measurement defective)</i> 545 Err.7	OFF	ON	1.2mA	Temperature measurement not plausible	
108	<i>ADC error (Temperature measurement error)</i> Rdu Err.2	OFF	ON	1.2mA	A/C Converter error (Temperature measurement/NTC)	
109	<i>Sensor error (No sensor detected)</i> SEr5 Err.1	OFF	ON	1.2mA	No sensor present/detected	Install sensor (automatic restart)
110	<i>Sensor error (Param. memory defective)</i> SEr5 Err.2	OFF	ON	1.2mA	Error during EEPROM access (Sensor)	Replace sensor (automatic restart)
111	<i>Sensor error (Param. memory error)</i> SEr5 Err.3	OFF	ON	1.2mA	Incorrect sensor/parameter memory	

Indications in Measuring Mode						
No.	Indication	Green LED	Yellow LED	Current output	Cause	Note/Explanation
201	↑↑↑↑ permanent ----- ” permanent	ON	ON	22mA	The gas concentration has exceeded the measuring range of the transmitter electronics	Reduce the gas concentration!!!
202	Measurement value in alternation with ↑↑↑↑ ----- Measurement value in alternation with ----- ”	ON	OFF	22mA	The gas concentration has greatly exceeded the measuring range ($\geq 112.5\%$ of the measuring range)	
203	Measurement value in alternation with ↑↑↑↑ ----- Measurement value in alternation with ----- ”	ON	OFF	20..22mA	The gas concentration has exceeded the measuring range (100...112.5% of the measuring range)	
204	Measurement value in alternation with <i>Alarm 2</i> ----- Measurement value in alternation with <i>R2</i>	ON	OFF	4...20mA	The gas concentration has reached/exceeded the 2nd alarm threshold	
205	Measurement value in alternation with <i>Alarm 1</i> ----- Measurement value in alternation with <i>R1</i>	ON	OFF	4...20mA	The gas concentration has reached/exceeded the 1st alarm threshold	
206	<i>Scaling warning</i> SCAL Err.	ON	OFF	4...20mA	Precautionary warning: Measuring range limit no longer detectable by hardware/sensor combination	Acknowledge with  a) Readjust sensor (SPAN) b) Adjust/reduce the measuring range in the service menu
207	<i>Check supply voltage</i> ----- CHECK SUPP	ON	OFF	4...20mA	Precautionary warning: The supply voltage is not in the required range	Check/adjust the supply voltage
208	<i>Sensor replacement</i> ----- CHANGE SENS	ON	Single pulses	4...20mA	Precautionary warning: The sensor life will expire in the next few months	Replace sensor during next maintenance
209	Measurement value	ON	OFF	4...20mA	Faultless measuring mode	
210	Measurement value	ON	OFF	2.8...4mA	Measuring range underflow (-7.5...0.0% of the measuring range)	
211	Measurement value	ON	ON	2.8mA	Measuring range underflow (< -7.5% of the measuring range)	Zeropoint calibration necessary
212	Measurement value in alternation with ↓↓↓↓ ----- Measurement value in alternation with ----- ”	ON	ON	1.2mA	Measuring signal below the measuring range of the transmitter electronics	Zeropoint calibration necessary, then check sensitivity

Note:

In measuring mode, the messages listed in the second column are displayed in alternation with the measurement value. The indications described in no. 204 and no. 205 only apply for the EC28 DA. The indications described in no. 206–208 are precautionary warning messages. The transmitter remains in measuring mode and an immediate action by the operator is not necessary. The conditions described in no. 203 and no. 210 relate to a de facto expansion of the measuring range of 4...20mA to the 2.8...22mA range in order to display measurement values 'close' to the actual measuring range. This creates a tolerance range around the 4...20mA before a special condition is displayed.

Indications in Service Mode and During Calibration						
No.	Indication	Green LED	Yellow LED	Current output	Cause	Note/Explanation
301	Menu item	ON	Blinks	2.4mA	Service menu was activated via keypad or the RC2	Select menu item Automatic return to measuring mode if no input occurs for one minute
302	ZERO ZER0	ON	Blinks	2.0mA	AutoCal adjustment of the zeropoint was activated via keypad, the RC2 or the AutoZero button	Automatic termination after successful calibration
303	SPAN SPRn	ON	Blinks	2.0mA	AutoCal adjustment of the sensitivity was activated via keypad or the RC2	Automatic termination after successful calibration
304	Cal. error (No conc. change) [RL Err.1]	ON	Blinks quickly	2.0mA	An increase in the calibration gas concentration was not detected during the AutoCal adjustment of the sensitivity	Acknowledge with  a) check gas feed b) Select calibration mode before gas feed
305	Cal. error (Gas not stable) [RL Err.2]	ON	Blinks quickly	2.0mA	No stable zero gas / calibration gas concentration was detected during the AutoCal adjustment	Acknowledge with  a) stabilise gas feed
306	Cal. error (Calibr. not plausible) [RL Err.3]	ON	Blinks quickly	2.0mA	The zeropoint / sensitivity is outside the permitted tolerance range	Acknowledge with  a) Check zero / calibration gas and repeat procedure. b) Replace sensor if necessary

Conditions of Status LED's and Current Output

The following table gives a better overview of the different indications of both status LED's and the current output signals and their meaning for a transmitter without display

The RC2 control unit is required for zeropoint calibration (when indication > 25% of the measuring range), for adjustment and for calling up the service menu in the case of a transmitter without display.

Green LED	Yellow LED	Current output	For a description, see section ...
ON	ON	2.8mA	<i>Indications in measuring mode</i> No. 211
ON	ON	1.2mA	<i>Indications in measuring mode</i> No. 212
ON	ON	0mA	<i>Indications of special conditions...</i> No. 001
ON	ON	22mA	<i>Indications in measuring mode</i> No. 201
ON	OFF	22mA	<i>Indications in measuring mode</i> No. 202
ON	Blinks quickly	2.0mA	<i>Indications in service mode...</i> No. 304–306
ON	Blinks slowly	2.4mA	<i>Indications in service mode...</i> No. 301
ON	Blinks slowly	2.0mA	<i>Indications in service mode...</i> No. 302, 303
ON	Single pulses	4...20mA	<i>Indications in measuring mode</i> No. 208
ON	OFF	20...22mA	<i>Indications in measuring mode</i> No. 203
ON	OFF	4...20mA	<i>Indications in measuring mode</i> No. 204–207, 209
ON	OFF	2.8...4mA	<i>Indications in measuring mode</i> No. 210
Blinks	ON	1.6mA	<i>Indications of special conditions...</i> No. 002, 003
Single pulses	ON	1.2mA	<i>Indications of special conditions...</i> No. 101
Double pulses	ON	1.2mA	<i>Indications of special conditions...</i> No. 102, 103
OFF	ON	1.2mA	<i>Indications of special conditions...</i> No. 104–111

Priority of Indications and Messages in Measuring Mode

The indication of conditions with lower priority are overwritten by indications with higher priorities. The conditions with lower priorities are not reset.

Priority	Condition	For a description, see section ...
	A/D converter fault	<i>Indications of special conditions...</i> No. 108
	Measuring range overflow	<i>Indications in measuring mode</i> No. 201–203
	Alarm2	<i>Indications in measuring mode</i> No. 204
	Alarm1	<i>Indications in measuring mode</i> No. 205
	Measuring range underflow	<i>Indications in measuring mode</i> No. 211, 212
	Power supply fault (Warning)	<i>Indications in measuring mode</i> No. 207
	'SCAL Error' (Warning)	<i>Indications in measuring mode</i> No. 206
	Sensor replacement (Warning)	<i>Indications in measuring mode</i> No. 208

System/sensor faults (No. 101 and No. 104–111) interrupt the measuring mode with their respective indication/message.

First Putting Into Operation and Maintenance

The DIN EN 50073 standard, 'Guide for the selection, installation, use and maintenance of apparatus for the detection and measurement of combustible gases or oxygen' and other national regulations must be observed. During the first putting into operation, gas detection systems must be checked for correct functioning by a qualified person after their installation (see DIN EN 50073, section 6.4.1)

The maintenance includes service, maintenance, calibration and adjustment, as well as regular functional checks and repair.

The checks must be done by a qualified person and a written record of the results must be kept.

Service, Maintenance, Calibration and Adjustment

The service should include visual checks on the gas detection system.

- Mechanical damage
- Contamination by dust
- Condensation due to moisture
- Protective devices for transmitters
- Diffusion openings of the transmitters
- Gas offtake system, gas processing (if installed)

Maintenance and adjustment consist of work that maintains the operability of the gas detection system. It should be done at regular intervals. An interval of 4 months should normally not be exceeded. (see DIN EN 50073, section 6.4.3).

- Zeropoint
- Sensitivity with test/calibration gas
- Tripping of the alarm thresholds
- Response time
- Output functions, visual and audible
- Fault/error messages/indications

We recommend that this work be done by GfG customer service.

Regular Functional Checks

Gas detection systems can behave differently depending on the environmental conditions. It is therefore important to carry out a daily visual check, particularly during the first few days after a new putting into operation.

The correct functioning of the gas detection system must be checked at regular intervals in addition to the maintenance work. The interval must not exceed 1 year.

The checks must be done by a qualified person and a written record of the results must be kept.

Repair

Repair means all repair and replacement work. Repair may only be performed by the manufacturer and persons authorised by the manufacturer – i.e. GfG Gesellschaft für Gerätebau mbH. Only original spare parts/assemblies tested and approved by the manufacturer may be used.

Fault – Cause – Remedy

Fault	Cause	Remedy
Zeropoint can no longer be adjusted	Defective sensor	Replace the sensor
Sensitivity can no longer be adjusted	Defective sensor	Replace the sensor
Output current level has dropped to 0mA	Defective fuse; Supply cable not connected	Replace the fuse; Make the connection

Accessories

	Part no.
RC2 control unit	2800201
EC28 calibration adapter for non-reactive gas for calibration of the transmitter	2810202
EC28 calibration adapter for reactive gas for calibration of the transmitter	On request
EC28 flow adapter	On request
Zener barrier SB 4420	On request

Connectors and Terminal Assignment

⇒ The number of terminals varies with the expansion level of the EC28.

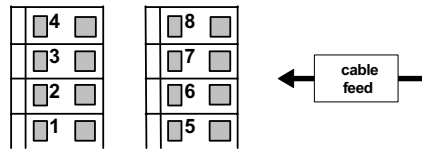

EC28 i with 4...20mA interface (two-wire) and Zener barrier

- 1: 21...27V DC power supply (in front of the Zener barrier, see the *Accessories* section)
- 2: 0V GND power supply

Current measuring (4...20mA) in the supply cable

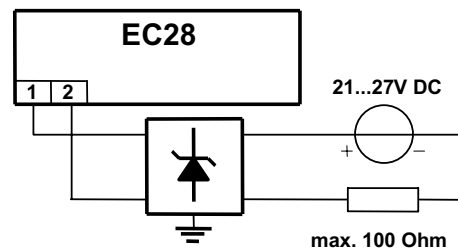

EC28 with 4...20mA interface (three-wire)

- 1: 18...30V DC power supply
- 2: 0V GND power supply
- 3: -
- 4: 4...20mA current output

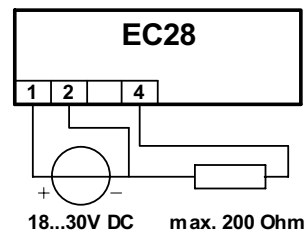

EC28 with 4...20mA interface (three-wire) and relay

- 1: 18...30V DC power supply
- 2: 0V GND power supply
- 3: -
- 4: 4...20mA current output

- 6: COM Relay
- 7: NO Relay
- 8: NC Relay

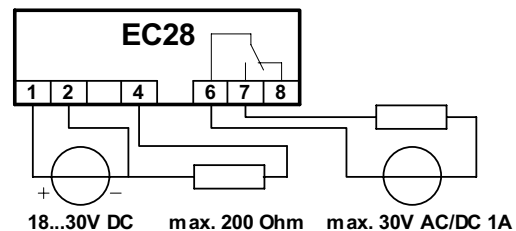

EC28 with MODBUS interface (RS-485)

- 1: 18...30V DC power supply
- 2: 0V GND power supply
- 3: Data+ (D1)
- 4: Data- (D0)
- 5: 18...30V DC power supply
- 6: 0V GND power supply
- 7: Data+ (D1)
- 8: Data- (D0)

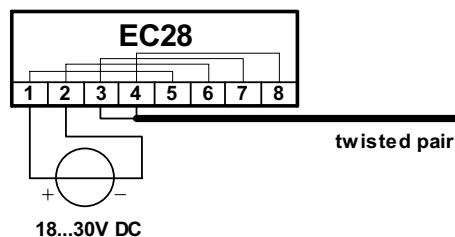

Note: See separate 'EC28 – MODBUS Implementation' documentation for operating specifications.

Measured gases and measuring ranges			
Measured gas	Standard measuring range	Smallest / largest measuring ranges	MK number
Ammonia (NH ₃)	0...100 ppm	0... 40 to 200 ppm	MK393-7
	0...500 ppm	0...200 to 1000 ppm	MK399-7
Chlorine (Cl ₂)	0...10 ppm	0...10 to 50 ppm	MK390-7
	0...50 ppm	0...50 to 250 ppm	MK304-4
Chlorine dioxide (ClO ₂)	0...2 ppm	0... 1 to 2 ppm	MK391-7
Hydrogen chloride (HCl)	0...10 ppm	0... 5 to 30 ppm	MK392-7
	0...50 ppm	0...40 to 200 ppm	MK309-7
Hydrogen cyanide (HCN)	0...50 ppm	0...10 to 50 ppm	MK409-7
	0...100 ppm	0...40 to 200 ppm	MK336-7
Ethylene oxide (C ₂ H ₄ O)	0...20 ppm	0...20 to 100 ppm	MK340-7
Hydrogen fluoride (HF)	0...10 ppm	—	MK412-7
Carbon monoxide (CO) with warning of H ₂ S	0...300 ppm	0...100 to 500 ppm	MK174-7
	0...1000 ppm	0...400 to 2000 ppm	MK174-4
Carbon monoxide (CO) without warning of H ₂ S	0...300 ppm	0...100 to 500 ppm	MK175-7
	0...1000 ppm	0...400 to 2000 ppm	MK175-4
Carbon monoxide (CO) without warning of H ₂ S reduced hydrogen cross sensitivity	0...300 ppm	0...100 to 500 ppm	MK369-7
Ozone (O ₃) for MAC monitoring	0...1 ppm	—	MK411-7
Ozone (O ₃) for leak monitoring	0...3 ppm	0...1 to 5 ppm	MK397-7
Phosgene (COCl ₂)	0...2 ppm	0...1 to 2 ppm	MK349-7
Oxygen (O ₂)	0...25 % by vol.	0...5 to 30 % by vol.	MK398-7
Sulphur dioxide (SO ₂)	0...10 ppm	0...10 to 50 ppm	MK306-7
	0...100 ppm	0...100 to 500 ppm	MK307-7
Hydrogen sulphide (H ₂ S)	0...50 ppm	0...40 to 200 ppm	MK176-7
	0...200 ppm	0...200 to 1000 ppm	MK177-7
Hydrogen sulphide (H ₂ S) reduced methanol cross sensitivity	0...50 ppm	0...40 to 200 ppm	MK429-7
Silane (SiH ₄)	0...20 ppm	0...10 to 50 ppm	MK404-7
Nitrogen dioxide (NO ₂)	0...30 ppm	0...10 to 50 ppm	MK310-7
	0...100 ppm	0...40 to 200 ppm	MK310-4
Nitrogen monoxide (NO)	0...100 ppm	0...50 to 300 ppm	MK179-7
	0...500 ppm	0...300 to 1500 ppm	MK179-4
Hydrogen (H ₂)	0...2000 ppm	0...400 to 2000 ppm	MK305-7
	0...1 % by vol.	0...0.2 to 1 % by vol.	MK402-7
	0...2 % by vol.	0...1 to 4 % by vol.	MK403-7

Sensor specification

MK174-7 (-4) Electrochemical sensor for carbon monoxide CO

Response time		t_{90} : <40 sec
Pressure	800...1200 hPa:	max. ± 3 ppm or $\pm 7\%$ of reading (at 1000 hPa)
Humidity	15%...90% R.H.:	max. ± 3 ppm or $\pm 7\%$ of reading (at 50% R.H.)
Temperature	-20...+40(50) $^{\circ}$ C:	max. $\pm 3(5)$ ppm or $\pm 7(10)\%$ of reading (at 20 $^{\circ}$ C)
Cross-sensitivities		H ₂ S \approx 250% , C ₂ H ₄ <100% , SO ₂ \approx 60% , H ₂ <60% , NO ₂ \approx 60% , HCN \approx 50% , Cl ₂ \approx 50% , NO \approx 30% (*1)
Anticipated life:		3 years

MK175-7 (-4) Electrochemical sensor for carbon monoxide CO

Response time		t_{90} : <45 sec
Pressure	800...1200 hPa:	max. ± 3 ppm or $\pm 7\%$ of reading (at 1000 hPa)
Humidity	15%...90% R.H.:	max. ± 3 ppm or $\pm 7\%$ of reading (at 50% R.H.)
Temperature	-20...+40(50) $^{\circ}$ C:	max. $\pm 3(5)$ ppm or $\pm 7(10)\%$ of reading (at 20 $^{\circ}$ C)
Cross-sensitivities		H ₂ S<2% , C ₂ H ₄ <100% , H ₂ <60% , HCN<20% , NO<20% , NO ₂ <10% , HCL=SO ₂ =Cl ₂ =0% , (*1)
Anticipated life:		3 years

MK176-7 Electrochemical sensor for hydrogen sulphide H₂S

Response time		t_{90} : <40 sec
Pressure	800...1200 hPa:	max. ± 1 ppm or $\pm 7\%$ of reading (at 1000 hPa)
Humidity	15%...90% R.H.:	max. ± 1 ppm or $\pm 7\%$ of reading (at 50% R.H.)
Temperature	-20...+50 $^{\circ}$ C:	max. ± 1 ppm or $\pm 7\%$ of reading (at 20 $^{\circ}$ C)
Cross-sensitivities:		SO ₂ <20% , NO ₂ <20% , Cl ₂ <-20% , HCN<-10% , NO<6% , CO<0.5% , H ₂ <0.1% (*1)
Anticipated life:		2..3 years

MK177-7 Electrochemical sensor for hydrogen sulphide H₂S

Response time		t_{90} : <40 sec
Pressure	800...1200 hPa:	max. ± 1 ppm or $\pm 7\%$ of reading (at 1000 hPa)
Humidity	15%...90% R.H.:	max. ± 1 ppm or $\pm 7\%$ of reading (at 50% R.H.)
Temperature	-20...+50 $^{\circ}$ C:	max. ± 1 ppm or $\pm 7\%$ of reading (at 20 $^{\circ}$ C)
Cross-sensitivities:		SO ₂ <20% , NO ₂ <20% , HCN<-15% , Cl ₂ \pm 5% , CO<2% , H ₂ <0.1% , NO=0% (*1)
Anticipated life:		2..3 years

MK179-7 (-4) Electrochemical sensor for nitrogen monoxide NO

Response time		t_{90} : <25 sec
Pressure	800...1200 hPa:	max. ± 1 ppm or $\pm 7\%$ of reading (at 1000 hPa)
Humidity	15%...90% R.H.:	max. ± 1 ppm or $\pm 7\%$ of reading (at 50% R.H.)
Temperature	-20...+35(50) $^{\circ}$ C:	max. $\pm 3(6)$ ppm or $\pm 7\%$ of reading (at 20 $^{\circ}$ C)
Cross-sensitivities:		H ₂ S \approx 35% , NO ₂ <30% , HCl<20% , SO ₂ =CO=NO=HCN=Cl ₂ =0% (*1)
Anticipated life:		3 years
Warm-up time:		3 minutes to one day – depending on switch-off duration

MK304-4 Electrochemical sensor for chlorine Cl₂

Response time		t_{90} : <70 sec
Pressure	800...1200 hPa:	max. ± 0.2 ppm or $\pm 10\%$ of reading (at 1000 hPa)
Humidity	15%...90% R.H.:	max. ± 0.2 ppm or $\pm 10\%$ of reading (at 50% R.H.)
Temperature	-20...+35(50) $^{\circ}$ C:	max. $\pm 0.3(0.5)$ ppm or $\pm 10\%$ of reading (at 20 $^{\circ}$ C)
Cross-sensitivities:		NO ₂ \approx 100% , H ₂ S<-10% , SO ₂ <-1% , H ₂ =HCN=HCl=NO=CO=0% (*1)
Anticipated life:		2..3 years

MK305-7 Electrochemical sensor for hydrogen H₂

Response time		t_{90} : <60 sec
Pressure	800...1200 hPa:	max. ± 5 ppm or $\pm 5\%$ of reading (at 1000 hPa)
Humidity	15%...90% R.H.:	max. ± 5 ppm or $\pm 10\%$ of reading (at 50% R.H.)
Temperature	-20...+40(50) $^{\circ}$ C:	max. $\pm 10(20)$ ppm or $\pm 20\%$ of reading (at 20 $^{\circ}$ C)
Cross-sensitivities:		C ₂ H ₄ \approx 80% , NO \approx 30% , HCN \approx 30% , CO<20% , H ₂ S<20% , SO ₂ =NO ₂ =Cl ₂ =HCl=0% (*1)
Anticipated life:		2..3 years

MK306-7 Electrochemical sensor for sulphur dioxide SO₂

Response time		t_{90} : <30 sec
Pressure	800...1200 hPa:	max. ± 0.2 ppm or $\pm 5\%$ of reading (at 1000 hPa)
Humidity	15%...90% R.H.:	max. ± 0.2 ppm or $\pm 5\%$ of reading (at 50% R.H.)
Temperature	-20...+50 $^{\circ}$ C:	max. ± 0.2 ppm or $\pm 5\%$ of reading (at 20 $^{\circ}$ C)
Cross-sensitivities:		H ₂ S \approx 130% , NO ₂ \approx 120% , HCN \approx 50% , Cl ₂ \approx 50% , HCl \approx 20% , CO<1% , NO=0% (*1)
Anticipated life:		2..3 years

MK307-7 Electrochemical sensor for sulphur dioxide SO₂

Response time		t_{90} : <30 sec
Pressure	800...1200 hPa:	max. ± 0.2 ppm or $\pm 5\%$ of reading (at 1000 hPa)
Humidity	15%...90% R.H.:	max. ± 0.2 ppm or $\pm 5\%$ of reading (at 50% R.H.)
Temperature	-20...+50 $^{\circ}$ C:	max. ± 0.2 ppm or $\pm 5\%$ of reading (at 20 $^{\circ}$ C)
Cross-sensitivities:		NO ₂ \approx 100% , Cl ₂ \approx 50% , HCN<50% , CO<2% , H ₂ S=HCl=H ₂ =NO=0% (*1)
Anticipated life:		2..3 years

MK309-7 Electrochemical sensor for hydrogen chloride HCl

Response time		t_{90} : <150 sec
Pressure	800...1200 hPa:	max. ± 1 ppm or $\pm 10\%$ of reading (at 1000 hPa)
Humidity	10%...95% R.H.:	max. ± 1 ppm or $\pm 10\%$ of reading (at 50% R.H.)
Temperature	-20...+35(50) $^{\circ}$ C:	max. $\pm 1(3)$ ppm or $\pm 15(30)\%$ of reading (at 20 $^{\circ}$ C)
Cross-sensitivities:		H ₂ S: 60..150% , SO ₂ : 30..70% , NO ₂ <10% , Cl ₂ : -5..+10% , HCN<3% , CO<1% , NO=0% (*1)
Anticipated life:		2..3 years
Warm-up time:		10 minutes to seven days – depending on switch-off duration

For (*1): Gas indication for the fed concentration in the range of MAC values

MK310-7 (-4) Electrochemical sensor for nitrogen dioxide NO₂		
Response time		t ₉₀ : <45 sec
Pressure	800...1200 hPa:	max. ±0.3ppm or ±5% of reading (at 1000 hPa)
Humidity	15%...90% R.H.:	max. ±0.3ppm or ±5% of reading (at 50% R.H.)
Temperature	-20...+40(50)°C:	max. ±0.3(0.5)ppm or ±5% of reading (at 20°C)
Cross-sensitivities:		Cl ₂ ≈100% , H ₂ S<-10% , SO ₂ <1% , HCl=HCN=H ₂ =NO=CO=0% (*1)
Anticipated life:		2..3 years
MK336-7 Electrochemical sensor for hydrogen cyanide HCN		
Response time		t ₉₀ : <150 sec
Pressure	800...1200 hPa:	max. ±1 ppm or ±10% of reading (at 1000 hPa)
Humidity	15%...90% R.H.:	max. ±1 ppm or ±10% of reading (at 50% R.H.)
Temperature	-20...+35(50)°C:	max. ±1(3) ppm or ±15% of reading (at 20°C)
Cross-sensitivities:		H ₂ S≈350% , SO ₂ <300% , NO ₂ <-300% , Cl ₂ ≈-50% , NO<40% , CO<12% , H ₂ =0% (*1)
Anticipated life:		2 years
MK340-7 Electrochemical sensor for ethylene oxide C₂H₄O		
Response time		t ₉₀ : <150 sec
Pressure	800...1200 hPa:	max. ±1ppm or ±15% of reading (at 1000 hPa)
Humidity	15%...90% R.H.:	max. ±2ppm or ±15% of reading (at 50% R.H.)
Temperature	-20...+30(50)°C:	max. ±1(3)ppm or ±15(20)% of reading (at 20°C)
Cross-sensitivities:		CO≈40% , CH ₄ O≈150% , C ₂ H ₂ ≈125% , CH ₂ O≈120% , CH ₄ S≈100% , C ₂ H ₄ ≈80% , C ₂ H ₆ O≈55% , C ₇ H ₈ ≈20% , MEC≈10% and others. (*1)
Anticipated life:		2..3 years
Warm-up time:		4 minutes to seven days – depending on switch-off duration
MK349-7 Electrochemical sensor for phosgene COCl₂		
Response time		t ₉₀ : <150 sec
Pressure	800...1200 hPa:	max. ±0.02ppm or ±10% of reading (at 1000 hPa)
Humidity	10%...95% R.H.:	max. ±0.02ppm or ±10% of reading (at 50% R.H.)
Temperature	-20...+40°C:	max. ±0.02ppm or ±10% of reading (at 20°C)
Cross-sensitivities:		C ₂ H ₆ O=CO ₂ =CO=Cl ₂ =H ₂ =HF=PH ₃ =SO ₂ : 0% HCN=H ₂ S: 0% (poisoning after long gas exposure) (*1)
Anticipated life:		1..1.5 years
MK369-7 Electrochemical sensor for carbon monoxide CO		
Response time		t ₂₀ : <10 sec t ₉₀ : <30 sec
Pressure	800...1200 hPa:	max. ±3ppm or ±10% of reading (at 1000 hPa)
Humidity	15%...90% R.H.:	max. ±3ppm or ±10% of reading (at 50% R.H.)
Temperature	-20...+50°C:	max. ±3ppm or ±15% of reading (at 20°C)
Cross-sensitivities:		H ₂ : <10% , NO: <9% , H ₂ S: 0% , SO ₂ : 0% (*1)
Anticipated life:		2..3 years
MK390-7 Electrochemical sensor for chlorine Cl₂		
Response time		t ₉₀ : <30 sec
Pressure	800...1200 hPa:	max. ±0.2ppm or ±10% of reading (at 1000 hPa)
Humidity	10%...95% R.H.:	max. ±0.2ppm or ±10% of reading (at 50% R.H.)
Temperature	-20...+50°C:	max. ±0.2ppm or ±10% of reading (at 20°C)
Cross-sensitivities:		F ₂ : ≈44% , ClO ₂ : ≈20% , NO ₂ : ≈12% , H ₂ S: ≈ -3% , HCl: <2% , CO: 0% , SO ₂ : 0% (*1)
Anticipated life:		2..3 years
MK391-7 Electrochemical sensor for chlorine dioxide ClO₂		
Response time		t ₉₀ : <120 sec
Pressure	800...1200 hPa:	max. ±0.05ppm or ±10% of reading (at 1000 hPa)
Humidity	10%...95% R.H.:	max. ±0.05ppm or ±10% of reading (at 50% R.H.)
Temperature	-20...+50°C:	max. ±0.05ppm or ±10% of reading (at 20°C)
Cross-sensitivities:		Cl ₂ : ≈90% , H ₂ S: ≈ -0.2% , H ₂ =CO ₂ =CO=GcH ₄ =B ₂ H ₆ : 0% (*1)
Anticipated life:		1..2 years
MK392-7 Electrochemical sensor for hydrogen chloride HCl		
Response time		t ₉₀ : <90 sec
Pressure	800...1200 hPa:	max. ±1ppm or ±10% of reading (at 1000 hPa)
Humidity	10%...95% R.H.:	max. ±1ppm or ±10% of reading (at 50% R.H.)
Temperature	-20...+50°C:	max. ±1ppm or ±10% of reading (at 20°C)
Cross-sensitivities:		PH ₃ : 300% , H ₂ S: 28% , Cl ₂ : 20% , HCN: 7% , CO: 1% , C ₂ H ₆ O=CO ₂ =H ₂ =HF=N ₂ : 0% (*1)
Anticipated life:		2..3 years
MK393-7 Electrochemical sensor for ammonia NH₃		
Response time		t ₉₀ : <60 sec
Pressure	800...1200 hPa:	max. ±1ppm or ±10% of reading (at 1000 hPa)
Humidity	10%...95% R.H.:	max. ±1ppm or ±10% of reading (at 50% R.H.)
Temperature	-20...+50°C:	max. ±1ppm or ±15% of reading (at 20°C)
Cross-sensitivities:		CO: 0% , CO ₂ : 0% , H ₂ : 0% , C ₂ H ₆ O: 0% , Cl ₂ : 0% , HCN: 0% , N ₂ : 0% , H ₂ S: 0% (in minutes range) (*1)
Anticipated life:		2..3 years
MK397-7 Electrochemical sensor for ozone O₃		
Response time		t ₉₀ : <150 sec
Pressure	800...1200 hPa:	max. ±0.03 ppm or ±10% of reading (at 1000 hPa)
Humidity	15%...90% R.H.:	max. ±0.03 ppm or ±10% of reading (at 50% R.H.)
Temperature	-20...+50°C:	max. ±0.05 ppm or ±15% of reading (at 20°C)
Cross-sensitivities:		ClO ₂ ≈200% , NO ₂ ≈80% , H ₂ S≈-70% , Cl ₂ ≈60% , SO ₂ ≈-50% , CO<0.1% (*1)
Anticipated life:		2..3 years

For (*1): Gas indication for the fed concentration in the range of MAC values

MK398-7 Electrochemical sensor for oxygen O₂			
Response time		t ₂₀ : <10 sec	t ₉₀ : <20 sec
Pressure	800...1200 hPa:	max. ±0.2% by vol.	or ±2.5% of measuring range (at 1000 hPa)
Humidity	0%...99% R.H.:	max. ±0.2% by vol.	or ±2.5% of measuring range (at 50% R.H.)
Temperature	-20...+40(50)°C:	max. ±0.3(0.5)% by vol.	or ±2(4)% of reading (at 20°C)
Anticipated life:		2 years in air	
MK399-7 Electrochemical sensor for ammonia NH₃			
Response time		t ₉₀ : <90 sec	
Pressure	800...1200 hPa:	max. ± 5ppm or ±10% of reading	(at 1000 hPa)
Humidity	10%...95% R.H.:	max. ± 5ppm or ±10% of reading	(at 50% R.H.)
Temperature	-20...+50°C:	max. ±10ppm or ±20% of reading	(at 20°C)
Cross-sensitivities:		CO=CO ₂ =H ₂ =C ₂ H ₆ O=Cl ₂ =HCN=N ₂ : 0% H ₂ S: 0% (in minutes range) (*1)	
Anticipated life:		2..3 years	
MK402-7 Electrochemical sensor for hydrogen H₂			
Response time		t ₉₀ : <90 sec	
Pressure	800...1200 hPa:	max. ±0.01% by vol. or ±10% of reading	(at 1000 hPa)
Humidity	10%...90% R.H.:	max. ±0.01% by vol. or ±10% of reading	(at 50% R.H.)
Temperature	-20...+50°C:	max. ±0.02% by vol. or ±20% of reading	(at 20°C)
Cross-sensitivities:		CO: <15% , Cl ₂ : ≈800% (*1)	
Anticipated life:		2..3 years	
MK403-7 Electrochemical sensor for hydrogen H₂			
Response time		t ₉₀ : <90 sec	
Pressure	800...1200 hPa:	max. ±0.01% by vol. or ±10% of reading	(at 1000 hPa)
Humidity	10%...90% R.H.:	max. ±0.01% by vol. or ±10% of reading	(at 50% R.H.)
Temperature	-20...+50°C:	max. ±0.02% by vol. or ±25% of reading	(at 20°C)
Cross-sensitivities:		CO: <15% (*1)	
Anticipated life:		2..3 years	
MK404-7 Electrochemical sensor for silane SiH₄			
Response time		t ₉₀ : <60 sec	
Pressure	800...1200 hPa:	max. ±0.1ppm or ±10% of reading	(at 1000 hPa)
Humidity	20%...95% R.H.:	max. ±0.2ppm or ±10% of reading	(at 50% R.H.)
Temperature	-20...+40°C:	max. ±0.2ppm or ±10% of reading	(at 20°C)
Cross-sensitivities:		PH ₃ : 130% , GeH ₄ : 100% , AsH ₃ : 70% , B ₂ H ₆ : 55% , Cl ₂ : -8% , CO: 4% , CO ₂ =H ₂ =HF=0% (*1)	
Anticipated life:		2 years	
MK409-7 Electrochemical sensor for hydrogen cyanide HCN			
Response time		t ₉₀ : <60 sec	
Pressure	800...1200 hPa:	max. ±0.5 ppm or ±10% of reading	(at 1000 hPa)
Humidity	10%...95% R.H.:	max. ±0.5 ppm or ±10% of reading	(at 50% R.H.)
Temperature	-20...+50°C:	max. ±0.5 ppm or ±15% of reading	(at 20°C)
Cross-sensitivities:		NO ₂ : -120% , Cl ₂ : ≈ -20% , CO: 0% , CO ₂ : 0% , H ₂ : 0% , HF: 0% , NO: 0% , PH ₃ : 0% (*1)	
Anticipated life:		2 years	
MK411-7 Electrochemical sensor for ozone O₃			
Response time		t ₉₀ : <60 sec	
Pressure	800...1200 hPa:	max. ±0.03 ppm or ±10% of reading	(at 1000 hPa)
Humidity	10%...95% R.H.:	max. ±0.03 ppm or ±10% of reading	(at 50% R.H.)
Temperature	-10...+45°C:	max. ±0.03 ppm or ±15% of reading	(at 20°C)
Cross-sensitivities:		Cl ₂ : 70..210% , ClO ₂ : 60..180% , NO ₂ : 60..80% , F ₂ : ≈70% , PH ₃ : 10% , H ₂ : ≈0% , HCN: -0.3% (*1)	
Anticipated life:		2 years	
MK412-7 Electrochemical sensor for hydrogen fluoride HF			
Response time		t ₅₀ : <40 sec	t ₉₀ : <90 sec
Pressure	800...1200 hPa:	max. ±0.2ppm or ±10% of reading	(at 1000 hPa)
Humidity	10%...80% R.H.:	max. ±0.2ppm or ±10% of reading	(at 50% R.H.)
Temperature	-20...+40°C:	max. ±0.2ppm or ±10% of reading	(at 20°C)
Cross-sensitivities:		Cl ₂ ≈40% , NO ₂ >1% , CO=CO ₂ =H ₂ S=H ₂ =0% (*1)	
Anticipated life:		1..2 years	
MK429-7 Electrochemical sensor for hydrogen sulphide H₂S			
Response time		t ₉₀ : <40 sec	
Pressure	800...1200 hPa:	max. ±3ppm or ±10% of reading	(at 1000 hPa)
Humidity	15%...90% R.H.:	max. ±3ppm or ±10% of reading	(at 50% R.H.)
Temperature	-20...+40(50)°C:	max. ±3ppm or ±10(15)% of reading	(at 20°C)
Cross-sensitivities:		SO ₂ : ≈20% , NO ₂ : ≈-20% , NO: <2% , CO: <1% , H ₂ : <0.1% , reduced methanol cross-sensitivity (*1)	
Anticipated life:		2..3 years	

For (*1): Gas indication for the fed concentration in the range of MAC values

Internal Parameter Memory of the EC28

Each transmitter is programmed with the data for the main gases and their additional parameters. This means that the user does not need to change the configuration in most cases. The following data is stored in the internal memory of the transmitter:

Gas type	Formula	Unit	CGAS Calibration gas	A1 Alarm 1	A2 Alarm 2	H1 Hyst. A1	H2 Hyst. A2	F1 A1 function	F2 A2 function
Carbon monoxide	CO	ppm	200	30	60	0	0	HNS	H SC
Hydrogen sulphide	H ₂ S	ppm	50	10	20	0	0	HNS	H SC
Chlorine	Cl ₂	ppm	5.0	0.5	1.0	0.0	0.0	HNS	H SC
Hydrogen cyanide	HCN	ppm	50	10	20	0	0	HNS	H SC
Hydrogen chloride	HCl	ppm	10	5	10	0	0	HNS	H SC
Nitrogen monoxide	NO	ppm	50	25	50	0	0	HNS	H SC
Nitrogen dioxide	NO ₂	ppm	20	5	10	0	0	HNS	H SC
Sulphur dioxide	SO ₂	ppm	10	2	4	0	0	HNS	H SC
Ammonia	NH ₃	ppm	100	50	100	0	0	HNS	H SC
Ethylene oxide	C ₂ H ₄ O	ppm	10	2	4	0	0	HNS	H SC
Ozone	O ₃	ppm	1.00	0.30	0.50	0.05	0.05	HNS	H SC
Oxygen	O ₂	% by vol.	20.9	19.0	17.0	0	0	LNS	L SC
Chlorine dioxide	ClO ₂	ppm	1.00	0.10	0.30	0.03	0.03	HNS	H SC
Hydrogen fluoride	HF	ppm	6.6	3.0	5.0	0.0	0.0	HNS	H SC
Phosgene	COCl ₂	ppm	1.0	0.1	0.2	0.0	0.0	HNS	H SC
Silane	SiH ₄	ppm	5	5	10	0	0	HNS	H SC
Hydrogen	H ₂	% by vol.	1.0	0.2	0.4	0	0	HNS	H SC
Hydrogen	H ₂	ppm	1000	1000	1500	0	0	HNS	H SC

Defined settings will be used if the transmitter is operated with a sensor for which data has not been entered in this list.

The user can individually modify these settings for this gas and then store them in the transmitter.

Technical Data – Part 1

Transmitter types	EC28, EC28 D, EC28 DA, EC28 DAR, EC28 B, EC28 DB and EC28 DAB
Measuring function	<p>Measured gas: Toxic gases and vapours and oxygen</p> <p>Measuring range: See inspection record</p> <p>Gas feed: Diffusion</p> <p>Response/Warm-up time: See sensor specification</p> <p>Measuring principle: Electrochemical</p> <p>Anticipated sensor life: See sensor specification</p> <p>Output signal: 4...20mA (max. load 200 Ohm) or two-wire Modbus (EC28 B... only)</p> <p>Alarm: Visual and audible 90dB @ 10cm (EC28 DA...only)</p> <p>Relay output: 1 changeover, potential-free (EC28 ...R only) Vmax=30V AC/DC, maximum short-circuit current of supply source 1A</p>
Power supply	<p>Supply voltage: 18...30V DC</p> <p>Maximum fault voltage: 250V AC or 45V DC (see type plate)</p> <p>Maximum supply current: 40 mA for EC28 & EC28 B 55 mA for EC28 D & EC28 DB 70 mA for EC28 DA & EC28 DAB 100 mA for EC28 DAR</p>
Climatic parameters	<p>Storage temperature: -25...+60°C (short-term) / 0...+30°C (recommended)</p> <p>Operating temperature (ambient): -20...+50°C (see also sensor specification)</p> <p>Humidity range: 5...90% R.H. (see also sensor specification)</p> <p>Atmospheric pressure range: 800...1100hPa (see also sensor specification)</p>
Enclosure	<p>Sensor mount: Stainless steel</p> <p>Enclosure material: Antistatic plastic. The enclosure must be protected against severe impact (> 4 J)!</p> <p>Dimensions: 115mm x 203mm x 55mm (W x H x D)</p> <p>Weight: approx. 800 grams (with display)</p> <p>Type of protection: IP 64</p> <p>Cable connector: Cable gland(s) M16 x 1.5 max. core cross-section 3(4) x 1.5mm²</p> <p>Cable type and length: LIYCY 3(4) x 0.75 mm², 500m max. (200m max. for EC28 DA...) or LIYCY 3(4) x 1.5mm², 1000m max.</p>
Approvals and tests	<p>Marking: Ⓜ II 2G CE₀₁₅₈</p> <p>Type of ignition protection: EEx em [ib] IIC T4 -20°C≤Ta≤+50°C</p> <p>EC Type-Examination Certificate: BVS 04 ATEX E 132 X</p> <p>Electromagnetic Compatibility (EMC): Compliant with DIN EN 50270 Disturbance emission: type 1 Interference immunity: type 2</p>

Technical Data – Part 2

Transmitter types	EC28i and EC28Di
Measuring function	<p>Measured gas: Toxic gases and vapours and oxygen</p> <p>Measuring range: See inspection record</p> <p>Gas feed: Diffusion</p> <p>Response time: See sensor specification</p> <p>Measuring principle: Electrochemical</p> <p>Anticipated sensor life: See sensor specification</p> <p>Output signal: 4...20mA <u>for Ex zone:</u> max. load 100 Ohm with Zener barrier, see <i>Accessories</i> section <u>not Ex zone:</u> max. load 200 Ohm without Zener barrier</p>
Power supply	<p>Supply voltage: 15...30V DC for inherently safe supply $V_i \leq 30V$ 21...27V DC for supply via Zener barrier, see <i>Accessories</i> section</p> <p>Maximum supply current: 25 mA</p>
Climatic parameters	<p>Storage temperature: -25...+60°C (short-term) or 0...+30°C (recommended)</p> <p>Operating temperature (ambient): -20...+50°C (see also sensor specification)</p> <p>Humidity range: 5...90% R.H. (see also sensor specification)</p> <p>Atmospheric pressure range: 800...1100hPa (see also sensor specification)</p>
Enclosure	<p>Sensor mount: Stainless steel</p> <p>Enclosure material: Antistatic plastic. The enclosure must be protected against severe impact (> 4 J) !</p> <p>Dimensions: 115mm x 203mm x 55mm (W x H x D)</p> <p>Weight: approx. 800 grams (with display)</p> <p>Type of protection: IP 64</p> <p>Cable connector: Cable gland(s) M16 x 1.5 max. core cross-section 3(4) x 1.5mm²</p> <p>Cable type and length: LIYCY 2 x 0.75 mm², 500m max. or LIYCY 2 x 1.5mm², 1000m max.</p>
Approvals and Tests	<p>Marking: Ⓢ II 1G CE₀₁₅₈</p> <p>Type of ignition protection: EEx ia IIC T4 -20°C ≤ Ta ≤ +50°C</p> <p>EC Type-Examination Certificate: BVS 04 ATEX E 132 X</p> <p>Electromagnetic Compatibility (EMC): Compliant with DIN EN 50270 Disturbance emission: type 1 Interference immunity: type 2</p>

EC Type-Examination Certificate



EXAM
BBG Prüf- und Zertifizier GmbH

Translation
2nd Supplement
(Supplement in accordance with Directive 94/9/EC Annex III number 6)
to the EC-Type Examination Certificate
BVS 04 ATEX E 132 X

Equipment: Transmitter type EC 28 ***
Manufacturer: Gesellschaft für Gerätebau mbH
Address: 44143 Dortmund, Germany

Description

The transmitter type EC 28 *** may also be manufactured according to the test documents provided with the appropriate test report; then it shall be marked type EC28 *** (details stated in the following table).

Type	Marking	Connection type / Functionality
EC28	II 2G EEx em [ib] IIC T4	4-20 mA, 1-Wire Bus
EC28 D	II 2G EEx em [ib] IIC T4	4-20 mA, 1-Wire Bus, Display
EC28 DA	II 2G EEx em [ib] IIC T4	4-20 mA, 1-Wire Bus, Display, Alarm LED and buzzer
EC28 B	II 2G EEx em [ib] IIC T4	RS485, 2-Wire Bus
EC28 DB	II 2G EEx em [ib] IIC T4	RS485, 2-Wire Bus, Display
EC28 DAB	II 2G EEx em [ib] IIC T4	RS485, 2-Wire Bus, Display, Alarm LED and buzzer
EC28 R	II 2G EEx em [ib] IIC T4	4-20 mA, 1-Wire Bus, Relays
EC28 DR	II 2G EEx em [ib] IIC T4	4-20 mA, 1-Wire Bus, Relays, Display
EC28 DAR	II 2G EEx em [ib] IIC T4	4-20 mA, 1-Wire Bus, Relays, Display, Alarm LED and buzzer
EC28 I	II 1G EEx ia IIC T4	4-20 mA (intrinsically safe)
EC28 DI	II 1G EEx ia IIC T4	4-20 mA (intrinsically safe), Display

The transmitter series type EC28 *** serves the purpose of detecting toxic gases and oxygen in a stationary mode in atmospheric conditions (i.e. electro-chemical and intrinsically safe sensor). For all types, be they type EC28, EC28 D, EC28 DA, EC28 B, EC28 DB, EC28 DAB, EC28 R, EC28 DR or EC28 DAR, the transmitter enclosure is manufactured to meet the requirements of the protection type "e", increased Safety. The transmitter is equipped with not intrinsically safe terminals for the supply and the output signal; furthermore, it comes with a module designed to meet the requirements of both protection types, Intrinsic Safety "i" and Encapsulation "m", and, depending on the type, with intrinsically safe interfaces.

Page 3 of 4 to BVS 04 ATEX E 132 X / 30
This certificate may only be reproduced in its entirety and without change.
Datenblattseite 9 4402 Bochum, Germany, Phone +49 234 906 110 Fax +49 234 906 111 E-mail: 23@tg-exam.de



EXAM
BBG Prüf- und Zertifizier GmbH

display units and buzzer.

The max. fault voltage U_{fa} at the not intrinsically safe terminals of types EC28, EC28 D, EC28 DA, EC28 B, EC28 DB, EC28 DAB, EC28 R, EC28 DR and EC28 DAR, respectively, lies at 45V DC or 250V AC, depending on the design in place. The corresponding identification of the U_{fa} is stated on the label.

For the intrinsically safe transmitters of types EC28 I and type EC28 DI, the same enclosure is used. Their intrinsically safe supply/signalling circuit (4-20 mA) is likewise connected via terminals.

The Essential Health and Safety Requirements of the modified equipment are assured by compliance with:

EN 50014:1997 + A1 - A2 General requirements
EN 60079-7:2003 Increased safety "e"
EN 50020:2002 Intrinsic safety "i"
EN 50028:1997 Encapsulation "m"
EN 50284:1999 Equipment Group II Category IG

The marking of the equipment shall include the following:

II 2G EEx em [ib] IIC T4 Type classification see page 1
II 1G EEx ia IIC T4 only for transmitter type EC28 I and type EC28 DI

Parameters

1 Transmitter type EC28, EC28 D, EC28 DA, EC28 B, EC28 DB, EC28 DAB, EC28 R, EC28 DR and EC28 DAR

1.1 Non-intrinsically safe supply circuit
Connected via terminals X1 and X2 at type EC28, EC28 D, EC28 DA, EC28 B, EC28 DB, EC28 DAB, EC28 DAB
Connected via terminals X1, X2, X3 and X8 at type EC28 B, EC28 DB, EC28 DAB

Rated supply voltage up to DC 30 V
Maximum voltage U_{fa} DC 45 or AC 250 V
The maximum voltage U_{fa} is stated on the label.

1.2 Non-intrinsically safe signalling circuit
Connected via terminals X3 and X2 at type EC28, EC28 D, EC28 DA, EC28 R, EC28 DR, EC28 DAR
Connected via terminals X3, X4, X7 and X8 at type EC28 B, EC28 DB, EC28 DAB

Rated signalling voltage up to DC 30 V
Maximum voltage U_{fa} DC 45 or AC 250 V
The maximum voltage U_{fa} is stated on the label.

1.3 Non-intrinsically safe relay contact circuit (charge-over contact)
Connected via terminals X6 up to X8 only at type EC28 B, EC28 DR, EC28 DAR

Rated switching voltage up to DC 30 V
Maximum switching voltage U_{fa} DC 45 or AC 250 V
Maximum short circuit current of power source 1 A

Page 2 of 4 to BVS 04 ATEX E 132 X / 30
This certificate may only be reproduced in its entirety and without change.
Datenblattseite 9 4402 Bochum, Germany, Phone +49 234 906 110 Fax +49 234 906 111 E-mail: 23@tg-exam.de



EXAM
BBG Prüf- und Zertifizier GmbH

1.4 Intrinsically safe potential-free opto-coupling interface, connected by four-pole plugs

Maximum input voltage U_i DC 6 V
Maximum input power P_i 45 mW
Maximum output current P_o 68 mA

Maximum internal capacitance C_i 110 nF
Maximum internal inductance L_i negligible

2 Transmitter type EC28 I and type EC28 DI

2.1 Intrinsically safe supply and signalling circuit, connected via terminals X1 and X2

Maximum input voltage U_i DC 30 V
Maximum internal capacitance C_i negligible
Maximum internal inductance L_i negligible

2.2 Intrinsically safe potential-free opto-coupling interface, connected by four-pole plugs

Maximum input voltage U_i DC 6 V
Maximum input power P_i 45 mW
Maximum output current P_o 68 mA

Maximum internal capacitance C_i 110 nF
Maximum internal inductance L_i negligible

3 Ambient temperature range for all types -20 °C up to +50 °C

Special condition for safe use

The enclosure of the transmitters of all types, i.e. type EC28, EC28 D, EC28 DA, EC28 B, EC28 DB, EC28 DAB, EC28 R, EC28 DR or EC28 DAR, meets the requirements for the low degree of mechanical hazards according to EN 50014, 23.4.3.1; thus it may only be used in such low-hazard areas or in areas where it is protected against mechanical hazards.

The measuring function for explosion protection is not subject of this supplement.

Test and assessment report
BVS PP 04.21.19.25 as of 18.09.2006

EXAM BBG Prüf- und Zertifizier GmbH
Bochum, dated 18. September 2006

Signed: Miganda Signed: Dr. Eickhoff
Certification body Special services unit

Page 3 of 4 to BVS 04 ATEX E 132 X / 30
This certificate may only be reproduced in its entirety and without change.
Datenblattseite 9 4402 Bochum, Germany, Phone +49 234 906 110 Fax +49 234 906 111 E-mail: 23@tg-exam.de



EXAM
BBG Prüf- und Zertifizier GmbH

We confirm the correctness of the translation from the German original.
In the case of arbitration only the German wording shall be valid and binding.

44809 Bochum, 20.03.2007
BVS-Rip/Ar E 0336/07

EXAM BBG Prüf- und Zertifizier GmbH

Miganda Certification body
Eickhoff Special services unit

Page 4 of 4 to BVS 04 ATEX E 132 X / 30
This certificate may only be reproduced in its entirety and without change.
Datenblattseite 9 4402 Bochum, Germany, Phone +49 234 906 110 Fax +49 234 906 111 E-mail: 23@tg-exam.de

EC- Declaration of Conformity GfG Gesellschaft für Gerätebau mbH

Klönnestrasse 99
D-44143 Dortmund
Tel: +49 (231) 56400-0
Fax: +49 (231) 516313
E-Mail: info@gfg-mbh.com
www.gfg.biz



EC28 i, EC28 Di

Edited: 18.09.2006

Amended:

GfG Gesellschaft für Gerätebau mbH develops, produces and sells gas sensors and gas warning devices, which are subject to a **quality management system** as per DIN EN ISO 9001 : 2000 - Certificate- Register No. 0410030302.

Subject to supervision by means of a **quality system** -Certificate No. BVS 03 ATEX ZQS / E 187- issued by the notified body, EXAM BBG Prüf- und Zertifizier GmbH, is the production of electrical apparatus of instrumentation Group I and II, categories M1, M2, 1G and 2G for gas sensors, gas detectors, gas warning systems in ignition protection classes explosion- proof encasing, increased safety, encapsulation and intrinsic safety, as well as their measuring function.

The transmitter **EC28 i, EC28 Di** complies with **directive 94/9/EC** for devices and protective systems for proper use in explosion endangered areas (ATEX- directive) and with **council directive 89/336/EEC** for electromagnetic compatibility.

For electrical explosion protection

BVS 04 ATEX E 132 X

⊗ II 1G EEX ia IIC T4

CE⁰¹⁵⁸

Labelling

The guidelines have been compiled with under consideration of the standards mentioned below:

■ Electrical explosion protection

- Electrical apparatus for potentially explosive atmospheres.
General requirements
EN 50014: 1997 + A1 - A2
- Intrinsic safety „i“
EN 50020: 2002
- Group II category 1 G
EN 50284: 1999

■ Electromagnetic compatibility

- Electrical apparatus for the detection and measurement of combustible gases, toxic gases and oxygen.
EN 50270 1999 (2000-01) Amendment (2000-10)
type class 1
type class 1 and 2

The evaluation of the basic safety and health requirements has been done, documented and filed by a notified body with register no. 0158 (EXAM BBG Prüf- und Zertifizier GmbH, Dimerstraße 9, D-44809 Bochum).
The EMC testing laboratory EM TEST GmbH, Kamen has been charged with testing and evaluation of the electromagnetic compatibility.

Always adhere to the safety notes of the operation manual 207-000.34

Dortmund, 09.10.2006

MBA H.J. Hübner
President CEO

ATEX 00406/09000007

EC- Declaration of Conformity GfG Gesellschaft für Gerätebau mbH

Klönnestrasse 99
D-44143 Dortmund
Tel: +49 (231) 56400-0
Fax: +49 (231) 516313
E-Mail: info@gfg-mbh.com
www.gfg.biz



EC28, EC28 D, EC28 DA,

EC28 B, EC28 DB, EC28 DAB

EC28 R, EC28 DR, EC28 DAR

Edited: 18.09.2006

Amended:

GfG Gesellschaft für Gerätebau mbH develops, produces and sells gas sensors and gas warning devices, which are subject to a **quality management system** as per DIN EN ISO 9001 : 2000 - Certificate- Register No. 0410030302.

Subject to supervision by means of a **quality system** -Certificate No. BVS 03 ATEX ZQS / E 187- issued by the notified body, EXAM BBG Prüf- und Zertifizier GmbH, is the production of electrical apparatus of instrumentation Group I and II, categories M1, M2, 1G and 2G for gas sensors, gas detectors, gas warning systems in ignition protection classes explosion- proof encasing, increased safety, encapsulation and intrinsic safety, as well as their measuring function.

The transmitter **EC28 (D,DA,B,DB,DAB,R,DR,DAR)** complies with **directive 94/9/EC** for devices and protective systems for proper use in explosion endangered areas (ATEX- directive) and with **council directive 89/336/EEC** for electromagnetic compatibility.

For electrical explosion protection

BVS 04 ATEX E 132 X

⊗ II 2G EEX em [ib] IIC T4

CE⁰¹⁵⁸

Labelling

The guidelines have been compiled with under consideration of the standards mentioned below:

■ Electrical explosion protection

- Electrical apparatus for potentially explosive atmospheres.
General requirements
EN 50014: 1997 + A1 - A2
- Increased safety „e“
EN 60079-7: 2003
- Intrinsic safety „i“
EN 50020 2002
- Encapsulation „m“
EN 50028 1987

■ Electromagnetic compatibility

- Electrical apparatus for the detection and measurement of combustible gases, toxic gases and oxygen.
EN 50270 1999 (2000-01) Amendment (2000-10)
type class 1
type class 1 and 2

The evaluation of the basic safety and health requirements has been done, documented and filed by a notified body with register no. 0158 (EXAM BBG Prüf- und Zertifizier GmbH, Dimerstraße 9, D-44809 Bochum).
The EMC testing laboratory EM TEST GmbH, Kamen has been charged with testing and evaluation of the electromagnetic compatibility.

Always adhere to the safety notes of the operation manual 207-000.34

Dortmund, 09.10.2006

MBA H.J. Hübner
President CEO

ATEX 00406/09000007



GfG Instrumentation

1194 Oak Valley Drive, Suite 20
Ann Arbor, Michigan 48108 USA

Phone: (800) 959-0329 or (734) 769-0573

Fax (734) 769-1888

E-mail: info@gfg-inc.com

Website: www.gfg-inc.com