

**Worldwide Supplier of Gas Detection
Solutions**



GfG Instrumentation
1194 Oak Valley Drive, Suite 20
Ann Arbor, MI 48108
800-959-0329 tel
734-769-1888 fax
email: info@gfg-inc.com

GMA41

Operation Manual

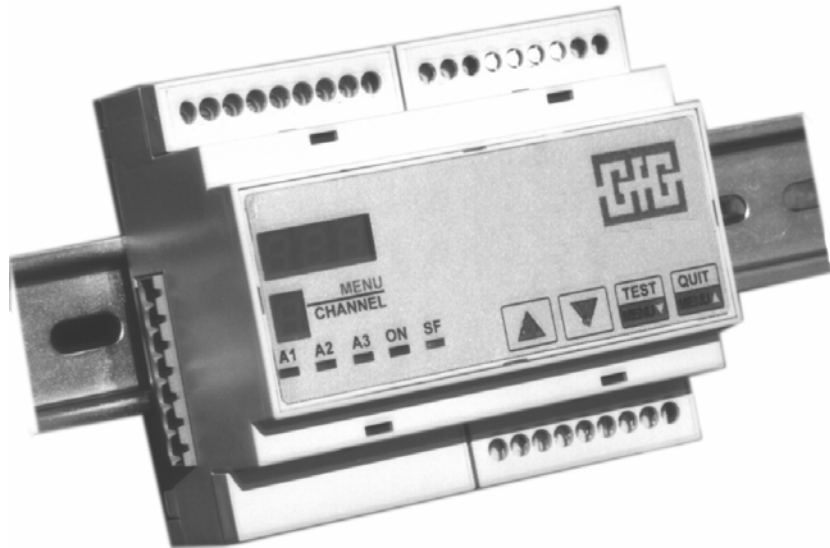

	Page
Introduction	3
Application and Purpose	3
For your Safety	4
Important for LEL Monitoring	4
Distinguishing the Types of GMA41	4
Detection Mode	5
Front View GMA41	5
Function Description	5
Turning On	5
Detection Mode	5
Peak Value Memory	6
Check of Display and Parameter	6
Alarm	7
Early Recognition of Gas Alarm – Delta Alarm (Catalytic Combustion Transmitter)	8
Time Delay of Alarms (#)	8
Fault	9
Relays	9
Service	10
Display of Transmitter Signal	10
Indication of Transmitter in Service Mode	10
Activation of Service Menus	10
Adjustments in Service Mode	11
Check of Relays and Logical Outputs	12
Setting of Alarm Thresholds	12
Check and Adjustment of Zeropoint	12
Check and Adjustment of Sensitivity	12
Alarm Threshold Hysteresis	13
Storing of Changed Parameters and Leaving the Service Mode	14
Maintenance	14
Inspection, maintenance, calibration and adjustment	14
Regular function tests	15
Overhaul	15
Influence of Interfering Gases and Oxygen	15
Instruction for Installation	15
Putting into Operation	16
Transmitter Cable	16
Accessories	16
Remarks concerning the Technical Safety of the GMA41	16
Trouble Shooting	17
Service Address	17
GMA41 - Gas List	18
Terminal Plan - GMA41	19
Technical Data	20
Applicational Hints from test report PFG-No. 41300500	21
Annex	22
Connection Diagram of Mains Units	23
Technical Data of Mains Units	24
Terminal Diagram of Transmitters	25

Introduction

Each detection point of your fixed gas monitoring system consists of a transmitter and a control module GMA41, which are connected by means of a transmitter cable. The GMA41 provides the power supply for the connected transmitter and receives and processes the sensor signals. Depending on the transmitter type, it monitors the ambient air for the presence of toxic or combustible gases and vapors or for its oxygen content.

The GMA41 offers a variety of features, which allow adapting the gas monitoring system to your specific requirements:

- Reading of linear measurement values in a 3-digit display
- Menu display
- 3 variably adjustable alarm thresholds
- Peak value memory
- Adjustable relay functions: NC / NO contact, open-circuit / closed circuit
- Alarm hystereses prevents “flickering” of relays
- 4 - 20 mA analog output signal.

The GMA41 continuously provides information on the measured gas concentration, exceeded alarm thresholds and its operational status. As soon as the gas concentration exceeds one of the three pre-set levels, the GMA41 gives a warning by means of the LED displays and controls the relevant alarm relays. In addition to this, the GMA41 provides the measurement value as an analog output signal for further evaluation. The GMA41 is easy to operate and maintenance-free. Should unexpected failures or system faults occur, the comprehensive failure recognition allows a quick and specific service.

Application and Purpose

In combination with the connected transmitter, the GMA41 forms a fixed gas monitoring system for continuous measurement of the gas concentration and for the warning from combustible gases and vapors in the LEL range, toxic gases and oxygen in the ambient air.

The function and accuracy of the GMA41 have been tested by "DMT-Deutsche Montan Technologie GmbH, Prüflaboratorium für Grubenbewetterung" for the use as a warning system for hazards from explosive gas mixtures. The test was based on DIN EN 50054 "Electrical apparatus for finding and measuring combustible gases - General requirements and test methods" and DIN EN 50057 "Electrical apparatus for finding and measuring combustible gases - Requirements of the operational behavior of Group II devices with a detection range up to 100 % of the Lower Explosion Limit" and prEN 50271 "Electrical apparatus for detection and measurement of combustible gases, toxic gases or oxygen. Requirements and tests for warning devices, which use software and/or digital technology". The tests included the listed standard detection ranges. The functions marked (#) have not been part of the function test.

The following standard ranges have been tested:			
Gas No.	Gas		Detection range
59	CH ₄	Methane	0 .. 100 %LEL
81	C ₃ H ₈	Propane	0 .. 100 %LEL
72	C ₉ H ₂₀	n-Nonane	0 .. 100 %LEL
40	C ₂ H ₅ OH	Ethanol	0 .. 100 %LEL

Function test: PFG-Nr. 41300500

For your Safety

According to § 3 of the law about technical working media, this manual points out the proper use of the product and serves to prevent dangers. As any piece of complex equipment, the GfG GMA41 will do the job designed to do, only, if it is used and serviced in accordance with the manufacturer's instructions. All individuals who have or will have the responsibility for using and servicing this product must carefully read this manual.

The warranties made by GfG with respect to the product are voided, if the adjustment of functions or parameters is changed without GfG's permission. They are also voided, if the product is not used and serviced in accordance with the instructions in this manual. Please protect yourself and your employees by following them. The above does not alter statements regarding GfG's warranties and conditions of sale and delivery.



Essential Notice:

For the parameter setting of the supplied GMA41 please refer to the test report. Modification of functions or parameters may affect the approval. GfG service is always at your disposal for adapting the monitoring system to your specific requirements.

Important for LEL Monitoring

If you use catalytic combustion (CC) transmitters for LEL monitoring, and if a suitable range has been adjusted on your GMA41 controller, please note the following: Due to the detection principle you cannot differ between sensor signals in the LEL range and signals for very high concentrations (e.g. > 20 Vol.% CH₄). This is why the GMA41 keeps an overrange signal stored, even if the transmitter sends lower signals in the meantime. This status is characterized by all gas and failure alarms being activated and by the display indicating the overrange situation (see page 7).



Do not press the QUIT button to reset the stored alarm status, before you have made sure that the gas concentration at the transmitter does no longer exceed the LEL range. Use a portable or fixed detector, for example, with a range from 0 to 100 Vol.-% to check.

Distinguishing the Types of GMA41

GMA Type	Transmitter Type	Built-in 230V mains unit	Supply voltage	Bus system
GMA41	All	no	24 V DC	no
GMA41 EC (#)	EC 24, EC 25 (0.2 .. 1mA)	yes	230 V AC / 24 V DC	no
GMA41 B	All	no	24 V DC	yes
GMA41 ECB (#)	EC 24, EC 25 (0.2 .. 1mA)	yes	230 V AC / 24 V DC	yes

The voltage supply of the controllers GMA41 EC and GMA41 ECB is specially designed for operating an electrochemical sensor. For all other transmitters you have to use the controllers GMA41 or GMA41 B. The pluggable bus system of the controllers GMA41 B and GMA41 EC B allows for easy interlinking up to 6 GMAs. The following signals are fed in the bus system:

- 24 V supply voltage
- Signal for alarm 1, alarm 2, alarm 3, fault

The key-operated switch can only be operated in combination with the GMA41 B or GMA41 ECB.

Detection Mode

Front View GMA41

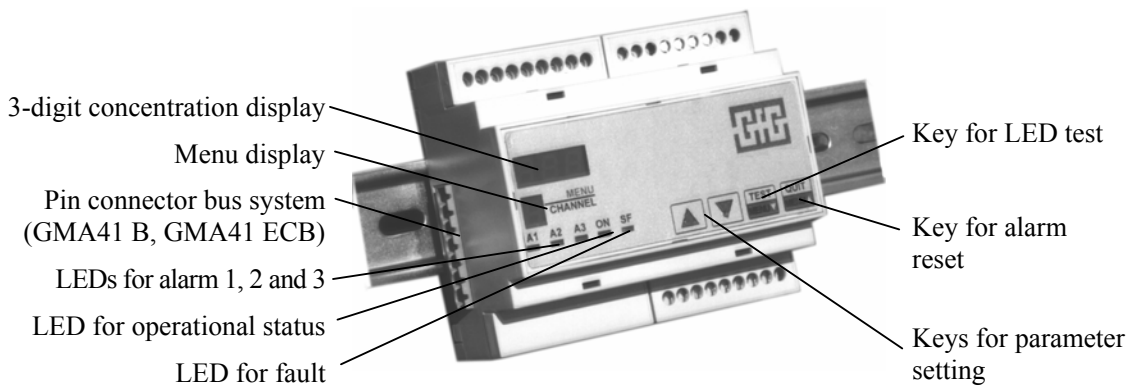

Fig. 1

Function Description

Turning On

Note: Information for putting into operation, see “putting into operation”.

After having turned the system on, the GMA 41 needs a warm-up time of a few minutes for:

- the self test, which checks functions, memory (ROM and RAM) and parameter memory (approx. 15 seconds),
- the warm-up of the transmitter connected
(for detailed information please refer to the operation manual of your transmitter).

During the warm-up period the GMA41 displays the detection range, the detection unit, measurement gas and the alarm thresholds one after the other. The LED „**ON**“ flashes alternately with the measurement display and the LED „**S F**“ is lit, i.e. the fault alarm is active. Alarm thresholds are not activated during the warm-up period. When the GMA41 re-starts after a mains failure, the gas alarms are only evaluated, once the warm-up is completed. After the warm-up the GMA41 automatically turns to detection mode.

Detection Mode

In detection mode, the green LED „**ON**“ is lit. If the 3-digit display is activated, it reads the currently measured gas concentration. All gases are measured continuously, and exceeded limit values are noticed and signalized immediately. Electronic functions like parameter memory and transmitters are monitored permanently and the transmitter cable is checked for short circuit and parting of the cable.

When operating transmitters with signal output 4..20 mA or 0.2..1 mA, which are calibrated for methane, propane (no linear sensor signal) or ethanol and n-nonane (linear sensor signal “standard”), the following display values occur:

Sensor signal





Input		Display		
I in mA	I in mA	Methane % LEL	Propane % LEL	Standard % LEL
0.20	4.0	0	0	0
0.24	4.8	9	5	5
0.28	5.6	18	9	10
0.32	6.4	25	14	15
0.36	7.2	31	19	20
0.40	8.0	36	24	25
0.44	8.8	41	29	30
0.48	9.6	46	34	35
0.52	10.4	50	38	40
0.56	11.2	54	43	45
0.60	12.0	58	48	50
0.64	12.8	62	53	55
0.68	13.6	66	58	60
0.72	14.4	70	63	65
0.76	15.2	74	69	70
0.80	16.0	79	74	75
0.84	16.8	83	79	80
0.88	17.6	87	84	85
0.92	18.4	91	89	90
0.96	19.2	96	95	95
1.00	20.0	100	100	100

Peak Value Memory

The controller GMA41 provides a peak value memory. Depending on the gas measured by the connected transmitter it stores either the maximum or the minimum value.

The peak value memory is not activated during the warm-up time.

Gas	Peak Value Memory
Oxygen	Minimum value
Comb. gases	Maximum value
Toxic gases	Maximum value

Press key  to indicate the peak value in the display. Measuring and warning functions are still working while the peak value is indicated. Press keys  and  simultaneously to reset the memory to the present measurement value. Once you release key , the controller returns to the standard display.

Check of Display and Parameter



During the test the measurement and warning functions are not activated!

LED Test

In detection mode, shortly press key  to activate the LED test of the GMA41 controller.



Fault LED is not tested → only in service menu!

Display of Detection Range and Alarm Thresholds

For the display of the detection range and the alarm threshold, keep key  pressed for approx. 5 seconds. The LED „ON“ flashes and the display reads the below mentioned parameters one after the other:

	Display, e.g.	LED ON – flashes, additionally lit:	Description of Display
1	100		Detection range
2	UEG, LEL, ppm, ppb		Detection unit
3	CH4, NH3, O2 GfG-Gas No.		Gas
4	20 (value in det. range)	A1	1. Threshold alarm
5	40 (value in det. range)	A2	2. Threshold alarm
6	40 (value in det. range)	A3	3. Threshold alarm

Once these readings are complete, the GMA41 automatically turns to detection mode.

Alarm



The GMA41 provides 3 threshold alarms, which are activated as soon as the gas concentration exceeds or falls below the alarm threshold. An activated alarm is indicated by means of the relevant alarm LED. Press key  or activate the external reset (see Technical Data) to acknowledge the alarm.

Alarm	Relevant Alarm LED
has been activated	Flashes
has been activated and acknowledged by pressing key 	lights permanently

Together with the alarm LEDs the GMA41 activates the relevant alarm relay and, for the models with bus system, the logical outputs. The standard setting for the switching functions is shown below:

Alarm	Function	Resettable during Alarm	Resettable after Alarm	Remark
1	Non-latching	No	self-resetting	
2	Latching	No	yes	
3	Latching	Yes	yes	Same threshold as alarm 2, meant as horn alarm

Overrange Memory

In case the detection range is exceeded by more than 10 %, the GMA41 activates the fault indication in addition to the 3 gas alarms. The display reads . When operating transmitters for the monitoring of 0..100%LEL, all alarms and the fault indication are latching, i.e. they can only be reset by pressing key , when the gas concentration has fallen below the full scale value.



Please see: “ Important for LEL Monitoring”

The switching functions can be set for the three alarms individually, GfG service can assist you with this.. For other settings than the standard ones please refer to the test report.

Remarks concerning Alarm Functions:

Exceeding / Deviating Alarm

If the reduction of the measured gas concentration means a hazardous situation, e.g. oxygen deficiency, the alarm is a deviating one. Exceeding alarms indicate a dangerous situation caused by rising gas concentrations, e.g. toxic and combustible gases.

Latching / Non-latching Alarm

A latching alarm remains valid until it is reset externally, e.g. by pressing key **QUIT** **MENU** at the GMA41. A non-latching alarm resets automatically, when the gas concentration falls below or exceeds the pre-set threshold.

Early Recognition of Gas Alarm – Delta Alarm (Catalytic Combustion Transmitter)

This function is only standard available for the use of catalytic combustion transmitters. Should you wish to activate this function for other transmitters as well, please call your GfG service.

The delta alarm is meant for early recognizing of hazards caused by sudden gas concentrations. The alarm activation is defined by the rise of gas concentration within a certain time. As soon as the gas concentration rises by 25 % of the full-scale deflection within 1.6 seconds (see fig. 2), the GMA41 indicates **overrange**.



Please see: “Important for LEL Monitoring”

For the activation of the delta alarm the gas concentration does not need to reach the pre-set alarm threshold. The Delta Alarm is an additional warning to the three thresholds for alarm 1, alarm 2 and alarm 3, which keep their standard functions..

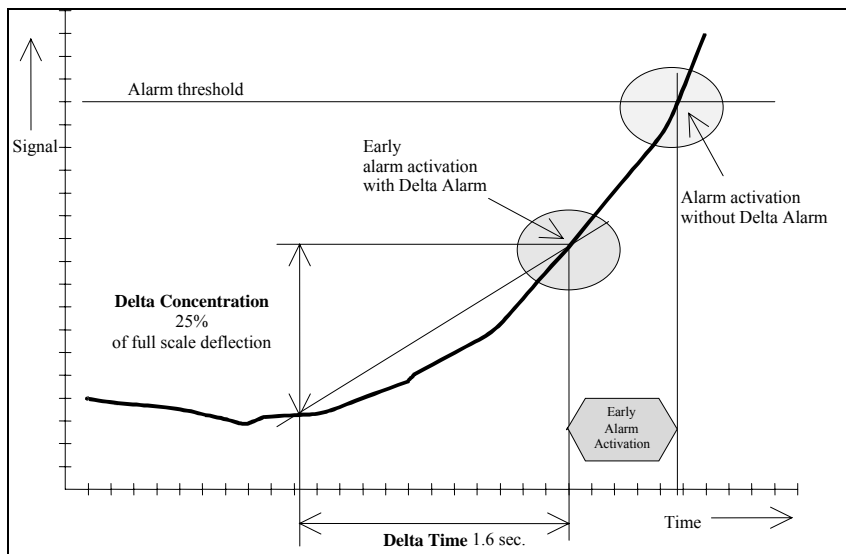

Fig. 2

Time Delay of Alarms (#)

This function, which is not activated in the standard setting, allows delaying the activation of the alarm (fig. 3). Should you wish to activate this function, please call your GfG service.

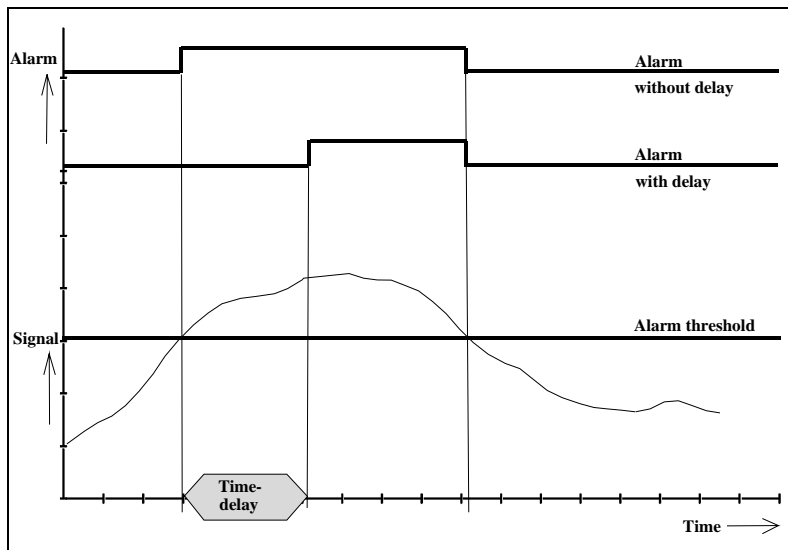

Fig. 3

The time delay prevents a warning from gas concentrations only exceeding the threshold for a very short time. It can be set from 0 to 2 minutes. For safety reasons the time delay should be kept as short as possible, and must not be activated in case of time-critical monitoring tasks.

Fault

In case of failure the yellow LED „**S F**“ lights up and the fault relay and the logic output are activated. A fault is signalized, if:

- the cable between Transmitter and GMA41 is cut;
- the sensor or the circuit of the transmitter is faulty;
- the zeropoint is deviated;
- the detection range is exceeded (together with alarm activation);
- the CPU self-monitoring is faulty.

As soon as the fault is repaired, the yellow LED “**S F**” goes out, the fault relay and the logic output deactivate and the GMA41 returns to standard detection mode.

Relays

The GMA41 provides 4 relays:

- 3 alarm relays for controlling external alarm devices,
- 1 fault relay for signaling of failures.

The switching behavior of the relays is the same as for alarm or fault signals. Every relay can be operated as NC or NO contact in closed or open circuit systems. For the switching functions as NC and NO relays you will find contact clamps. In the standard setting all 4 relays are NO contacts. The alarm relays are standard operated as open circuit system; the fault relay is a closed circuit. This results in the below mentioned switching functions:

In the standard setting the switching functions of the relays are as follows:

Relays for:	The relay switches:							
	in detection mode (no gas)	during gas alarm		after gas alarm		in case of mains failure	in case of failure	in case of gas alarm and failure
		not reset	reset	not reset	reset			
Alarm 1								
Alarm 2								
Alarm 3								
Fault								

It is essential to take note of the switching behavior of the relays when connecting external devices. In the standard setting alarm 3 (buzzer relay) can be reset even during gas alarm!

For special settings of the relay switching functions please contact your GfG service.

Service

Display of Transmitter Signal

Press key and after approx. 2 seconds the GMA41 displays the signal received from the transmitter in mA (0.2 .. 1 mA for transmitters with 0.2-1 mA output and 4 .. 20 mA for transmitters with 4-20 mA output). This function allows checking the zeropoint of the transmitter at the GMA41.

Indication of Transmitter in Service Mode

This function is only available for Transmitter CC24 EX (type 243x II), CS24 EX and EC25.

The transmitters CC24 EX, CS24 EX, EC25 provide a service switch. When this is activated during maintenance (see operation manual for the transmitter), the GMA41 automatically turns to fault indication. Alarm signals are being suppressed.

Activation of Service Menus

The 4..20 mA voltage output continuously reads the actual measurement value!

The service menus allow to select and to change all important parameters of the GMA41. A security code protects the service menus A and B from accidental maladjustment and unauthorized access. Adhere to the following procedure to enter the service menus:

1. Press key then key and keep both keys pressed, until „SER“ is read in the display.
2. Use keys and to enter the security code.

	Security Code	Adjustments
Menu A	11	Alarm thresholds and adjustment
Menu B	222	Deactivation points of alarm thresholds





3. Press key  to confirm the entered security code.
The GMA41 turns to the selected service menu

or













- Press key  to return to detection mode.







In the service mode the gas alarms are locked. The GMA41 switches to fault. The LEDs “ON“ and „S F“ light up, the fault relay is activated.

Adjustments in Service Mode



The display of the GMA41 reads the set parameters. The menu display indicates the menu point, where the displayed parameter value can be found. Use keys  and  to scroll forward and back. For changing of parameters use keys  and .

Survey of Menu Points







Menu A  	Description	Display, e.g.	Parameter Setting
	Relay test	r 1	
The menu starts with “G 1”			
	Detection unit	LEL, ppm	Display only
	Gas	CH ₄ , NH ₃ , O ₂ or GfG-Gas No.	
	Threshold Alarm 1	Value in detection range	Adjustment with  and 
	Threshold Alarm 2	Value in detection range	
	Threshold Alarm 3	Value in detection range	
	Zeropoint adjustment	0	
	Sensitivity adjustment	Value in detection range	

Menu B  	Description	Display, e.g.	Parameter Setting
	Threshold Alarm 1	Value in detection range	Adjustment with  and 
	Threshold Alarm 2	Value in detection range	
	Threshold Alarm 3	Value in detection range	

Check of Relays and Logical Outputs

The display of the GMA41 reads “rL”. The relays and logic outputs can be switched, one after the other, by pressing the keys  and . The relevant LEDs for alarm and fault indicate, which relay (and which logical output) was activated. When you set up this menu all alarms are deleted and afterwards newly set.

Setting of Alarm Thresholds

1. Activate service **menu A**.
2. Use keys  and  to select menu point ,  or  for the alarm threshold to be set.
3. Set the new alarm threshold by means of keys  and .
4. Store the parameters (see storing of changed parameters).

Adjustable alarms	
Highest alarm	Lowest alarm
End of measurement range	Begin of measurement range + Hysteresis

Check and Adjustment of Zeropoint

1. Supply zero gas to the transmitter or make sure, that the ambient air is free from interfering gases. Zero gas is a test gas, which is free from combustible or any other interfering components. For details about the gas supply please refer to the operation manual of your transmitter.
2. Wait until the display value is stable. The zeropoint must be adjusted, if the display is different from “0”.

Use key  to check the transmitter signal. An adjustment of the zeropoint is only possible, if the transmitter signal is within a tolerance band:





For a transmitter with 0.2 ... 1 mA: Tolerance of 0.15 ... 0.34 mA

For a transmitter with 4 ... 20 mA: Tolerance of 3 ... 6.8 mA

(Depending on the transmitter, slightly different tolerances are possible.)



If the transmitter signal is out of the tolerance band, the zeropoint has to be adjusted at the transmitter first! For details please read the operation manual of the transmitter!

3. Activate service **menu A**.
4. Use keys  and  to select menu point .
5. Press  key for 3 seconds to adjust the zeropoint
The adjustment of the zero point was successful, when the value „0“ is flashing in the display.
If the display is not flashing, the transmitter signal is out of tolerance and has to be adjusted at the transmitter first. Please adhere to the operation manual of your transmitter.
6. Disconnect the zero gas from the transmitter. In case of an oxygen transmitters wait until the displayed gas concentration exceeds the threshold alarm.
7. Store the parameter.

After the zeropoint adjustment, the sensitivity needs to be checked and eventually adjusted.

Check and Adjustment of Sensitivity

Note: Before checking the sensitivity, make sure that the zeropoint is set correctly.

The GMA41 allows checking and adjusting the sensitivity by means of the peak value memory. This memory is activating automatically, when the menu point  is turned on for 2.5 minutes. The GMA41 indicates the activated peak memory by a flashing display.

Check and Adjustment of Sensitivity without Peak Memory

1. Activate service **menu A**.

- Use keys **TEST MENU** and **QUIT MENU** to select menu point **[]**.
- Supply test gas to the transmitter. For details about the gas supply please refer to the operation manual of your transmitter.
- Wait until the display value is stable. The sensitivity must be adjusted, if the displayed value is different from your test gas concentration.
- Use keys **[▲]** and **[▼]** to set the parameter value to the concentration of your test gas.
- Disconnect the test gas supply from the transmitter. In case of transmitters for toxic or combustible gases wait until the displayed gas concentration falls below the threshold alarm.
- Store the parameter.

Check and Adjustment of Sensitivity with Peak Memory

This adjustment uses the possibility of the GMA41 to store the peak signal value measured during the duration of the test gas supply. The store peak values can be used as sensitivity point. Fig. 4 below shows this procedure.

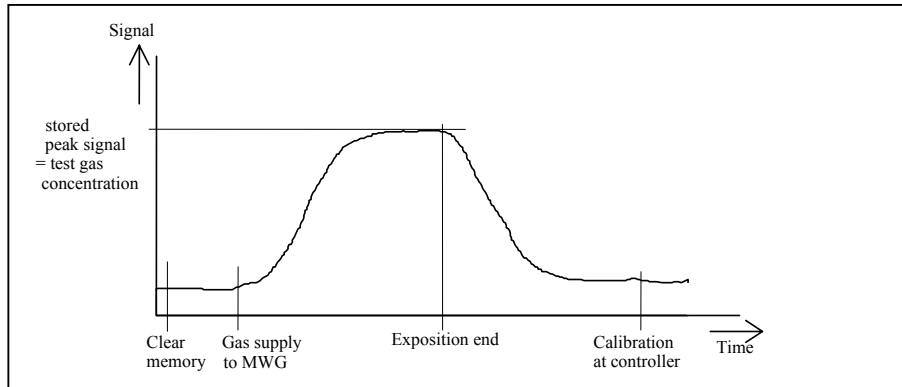

Fig. 4

- Activate service **menu A**.
- Use keys **TEST MENU** and **QUIT MENU** to select menu point **[]**.
- After 1.5 minutes supply test gas to the transmitter and make sure that the gas is constantly supplied for at least 3 minutes. For details about the gas supply please refer to the operation manual of your transmitter.
- Disconnect the test gas source from the transmitter.
- Use keys **[▲]** and **[▼]** to set the parameter value to the test gas concentration.
- Store the parameter.

Alarm Threshold Hysteresis







This function allows adjusting the hysteresis (point of deactivation) of the alarm thresholds. For exceeding alarms this point can be set from the start of the detection range up to two digits below the alarm threshold. For deviating alarms the deactivation point can be set from two resolution units above the alarm threshold up to the end of the detection range. The parameter setting is done in the unit of the gas to be measured.

Example:

The hysteresis of a controller, which monitors gas in the LEL range, was set to 18 % LEL for alarm 1, 36 % LEL for alarm 2 and 54 % LEL for alarm 3. This results in the following alarm activations:



	Alarm 1	Alarm 2	Alarm 3
Alarm threshold	= 20 % LEL	= 40 % LEL	= 60 % LEL
Alarm activation	≥ 20 % LEL	≥ 40 % LEL	≥ 60 % LEL
Alarm deactivation	≤ 18 % LEL	≤ 36 % LEL	≤ 54 % LEL

Adjustment of deactivation point:

1. Activate service **menu B**.
2. Use keys  and  to select menu point ,  or  for the alarm deactivation point to be set.
3. Use keys  and  to adjust the new deactivation point.
4. Store the parameter.

Storing of Changed Parameters and Leaving the Service Mode

All changes done in the service mode have to be stored:

1. Press keys  and  simultaneously to activate the memory function. The display reads „Sto“.
2. **Confirm storage:** Press key  to confirm the storage of the parameter. The GMA41 stores all changed parameters and returns to detection mode.

or

No storage: Press key , and the GMA41 returns to detection mode without storing the changed parameters.



You can change several parameters one after the other, without storing them individually. Once you have set all parameters, one storage confirmation is sufficient to store all changed parameters.

Maintenance

After the installation of a gas warning system and before putting it into operation, a function test must be carried out. The maintenance of a gas warning system contains, according to the „Guidelines for Explosion Protection“, and the „UVV-Gases“ the inspection, service, calibration and adjustment, regularly function tests and the maintenance.

In the DIN EN 50073 “information sheet for selection, installation, usage and maintenance of devices for detection and measurement of combustibles or oxygen”, information sheet T 023 “Gas warning devices for explosion protection – Usage and Operation“ and the UVV-gases “accident protection regulations for gases” the responding measures are laid down.

Inspection, maintenance, calibration and adjustment

During the inspection examinations of the gas measurement systems shall be carried out (see information sheet T 023, section 8.1).

- Pollution by dust
- Condensation by humidity
- Protective equipment for transmitters
- Diffusion inlet for the transmitter

Maintenance and adjustment describe those measures, which retain the nominal status of the gas warning system. They shall be checked in regular inspection intervals. Inspection intervals should not exceed 4 months (see information sheet T023, section 8.2, 8.3 and DIN EN 50073, Section 6.4.3).

- Zeropoint
- Sensitivity
- Activation of alarm thresholds
- Response time
- Alarm output visible and audible
- Fault report

Regular function tests

Additionally to the maintenance the function of the gas warning system has to be examined regularly. The function tests may not exceed a period of one year (see information sheet T023, Section 8.5 and UVV-gases § 56).

Overhaul

Overhaul describes all repairs and exchange of components. This has to be done by the manufacturer or persons authorized by him. Only those spare parts and structural components that have been tested and approved by GfG may be used for exchange.

We recommend a regular function test, calibration and to call GfG's service for the regular maintenance.

Influence of Interfering Gases and Oxygen

Interfering gases, oxygen surplus and oxygen deficiency may affect the measurement of gases by the transmitter. Please adhere to the operation manual of your transmitter.

Instruction for Installation

The GMA41 controller must not be installed in hazardous areas. It shall preferably be vibration-free installed. The transmitter and the mains supply are connected according to the terminal diagram. Make sure that the shield of the transmitter cable is already grounded close to the terminals of the GMA41 on the metal mounting plate, e.g. by means of EMC earth clips.

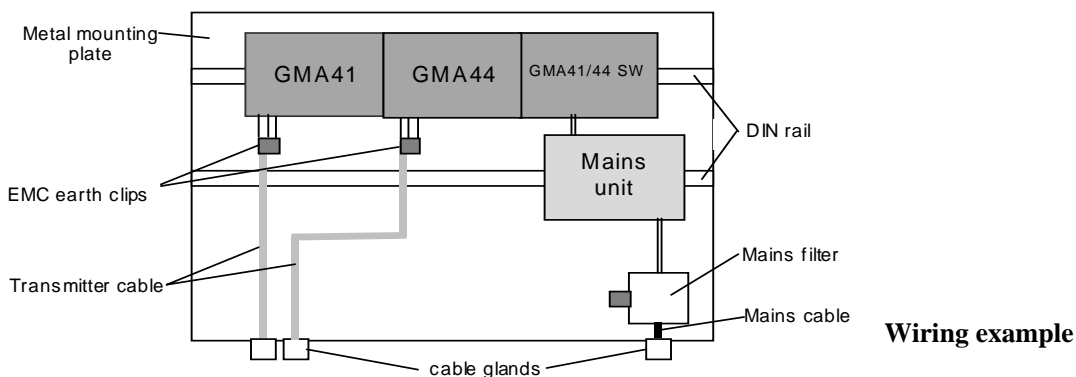

Inside the wall mount casing or the cabinet the transmitter cable should be laid separately from other control and mains cable. The mains supply for the GMA41 is generally to be fed over a mains filter (e.g. FN 610). This filter should also be mounted and grounded on a metal mounting plate close to the cable entry. Once the GMA41 is mounted into a casing and all transmitters, control groups and the mains supply are connected, an expert can put the system into operation. For installation and putting into operation of the transmitters please see the operation manual of your transmitter

Putting into Operation

After installation gas warning systems have to be tested for faultless functioning, be adjusted and put into operation, by an expert. The testing and adjustment shall be carried out in accordance with the manufacturer's operation manual. They are only allowed to be carried out by an expert (see information sheet T 023 8/99, section 6.3, as well as DIN EN 50073, Section 6.4.1).

Please call GfG's service, or an expert authorized by GfG for putting into operation.

Transmitter Cable

The GMA41 controller and the transmitter are connected by means of a shielded transmitter (data) cable (LiYCY). The cross section of the cable cores depends on the current consumption of the transmitter and on the cable length (see connection diagram in the manual's annex). Even with the maximum cable lengths the specific power supply for the transmitter has to be guaranteed. For detailed information please refer to the operation manual of your transmitter.

Accessories



Key-operated Switch Module GMA41/44 SW (#):	The module GMA41/44 SW allows to control a collective alarm. In addition to this, it provides the possibility of alarm suppression, e.g. during service or maintenance.
--	---

Remarks concerning the Technical Safety of the GMA41

Contact Protection

Mains supply and relay contacts of the GMA41 provide insulation distances of 3 mm, i.e. they are designed for 250 V operational insulation. In case a contact is operated on a contact-critical potential, the contacts close to it are also considered as contact-critical. According to contact protection the contacts are not considered to be separated safely. Resulting from this, the same applies to the relay contacts of a controller operated on 230 V. Here an operational insulation has been provided as well. The insulation of the secondary circuit from the primary circuit and the relay contacts complies with the requirements for contact protection. Distances of 6.5 mm ensure a safe separation. The secondary circuit operates on extra-low safety voltage.

Trouble Shooting

Failure	Cause	Solution
LED "S F" lights up, display „EEP“	- System error, fault in parameter memory	- Re-start of system - Call GfG service
LED "S F" lights up, LED „ON“ flashes	- System is in warm-up period, alarm suppression is still active	- Wait until warm-up period is over
LEDs do not light up	- Faulty voltage supply, defective fuse or mains unit	- Ensure proper voltage supply
Sensor signal, but gas-free atmosphere	- Incorrect calibration, incorrect zeropoint adjustment	- Adjust the zeropoint, calibrate
Display  LED „S F“ lights up	- ADC overrange - stored overrange - short circuit at the transmitter cable	- If there is a gas-free atmosphere at the transmitter, you can reset the stored measurement value check transmitter cable/renew - check transmitter cable/renew
Display  LED „S F“ lights up	- Display deviation (< -99) - ADC range deviation - Cable cut - Zeropoint deviation by 25% signal output 4..20 mA = 3 mA 0,2 mA = 0,15 mA - Service-signal / transmitter - short circuit at the transmitter cable	- Check calibration of transmitter and GMA controller - Check transmitter cable - Check calibration of transmitter and GMA controller Check service key - Check transmitter cable

Service Address

For additional questions on the product or in case of failure and problems please contact:

GfG Instrumentation, Inc.
1194 Oak Valley Drive
Suite 20
Ann Arbor, Mi. 48108
Phone: 734-769-0573
Fax: 734-769-1888
E-Mail: info@gfg-inc.com
Web: www.gfg-inc.com

GMA41 - Gas List

Gas Nr.	Gas	Chemical Formula	GMA Nr
1	Acetone	CH6O	1
2	Acetonitrile	C2H3N	2
3	Acetylene	C2H2	3
4	Acrylnitrile	C3H3N	4
5	Aminopropane	C3H9N	5
6	Ammonia	NH3	nh3
7	Amyl alcohol	C5H12O	7
8	Benzine 60/95	Mixture	8
9	Benzine 80/110	Mixture	9
10	Benzine (fuel)	Mixture	10
11	Benzene	C6H6	11
12	Comb. gases and vapours	Mixture	12
13	Bromtrifluoromethane (Halon)	C Br F3	13
14	Butadien - 1.3	C4H6	14
15	n-Butane	C4H10	but.
16	i-Butane	(CH3)3CH	16
17	Butanol - 1	C4H10O	17
18	Butanon - 2	C4H8O	18
19	n-Butylacetate	C6H12O2	19
20	i-Butylacetate	C6H12O2	20
21	n-Butyl alcohol	C4H10O	21
22	1-Butylene	C4H8	22
23	Chlorine	Cl2	CL2
24	Chloromethane	CH3Cl	24
25	Hydrogen chloride	HCl	HCL
26	Hydrogen cyanide	HCN	hcn
27	Cyclohexane	C6H12	27
28	Cyclopentan	C5H10	28
29	Cyclopropane	C3H6	29
30	Dichlordifluoromethane (R12)	C Cl2 F2	30
31	1.1 Dichlorethane	C2H4Cl2	31
32	Dichlorfluoromethane (R21)	CH Cl2F	32
33	Dichloromethaen	CH2Cl2	33
34	1.2 Dichloropropane	C3H6Cl2	34
35	Diethylamine	C4H11N	35
36	Dimethylether	C2H6O	36
37	Epichlorhydrin	C3H5Cl O	37
38	Natural gas (H+L)	Cn Hm, N2	38
39	Ethane	C2H6	39
40	Ethanol	C2H5OH	Eol.
41	Ethyl acetate	C4H8O2	41
42	Ethyl alcohol	C2H6O	42
43	Ethylen	C2H4	43
44	Ethylen oxide	C2H4O	44
45	FAM-Benzine	Mixture	45
46	Jet fuel 40/180	Mixture	46
47	Formaldehyde	CH2O	47
48	Frigen 22	CH Cl F2	r22
49	Helium	He	49
50	Heptane	C7H16	50
51	n-Hexane	C6H14	51
52	i-Hexane	C6H14	52
53	Hexanon-2	C6H12O	53
54	Isobutyl acetate	C6H12O2	54

Gas Nr.	Gas	Chemical Formula	GMA Nr
55	Carbon dioxide	CO2	CO2
56	Carbon monoxide	CO	CO
57	Coke gas	CO, CH4, H2	57
58	Air	N2, O2, CO2	58
59	Methane	CH4	CH4
60	Methanol	CH4O	60
61	Methyl acetate	C3H6O2	61
62	Methyl alcohol	CH3OH	62
63	Methylbutylketone	C6H12O	63
64	Methyl chloride	CH3Cl	64
65	Methylene chloride	CH2Cl2	65
66	Methyl-i-butylketone	C6H12O	66
67	Methylethylketone	C4H8O	67
68	Methylglycol	C3H8O2	68
69	Methylmethacrylate	C5H8O2	69
70	Methylpropanol	C4H10O	70
71	Monochlordifluoromonobrom.	C Br Cl F2	71
72	n-Nonane	C9H20	non.
73	i-Octane	C8H18	73
74	n-Octane	C8H18	74
75	i-Pentane	C5H12	75
76	n-Pentane	C5H12	76
77	Pentanon-2	C5H10O	77
78	Penten-1	C5H10	78
79	Pentyl acetate	C7H14O2	79
80	Perchloroethylene	C2Cl4	80
81	Propane	C3H8	Pro.
82	Propanol-2	C3H8O	82
83	i-Propyl acetate	C5H10O2	83
84	n-Propyl acetate	C5H10O2	84
85	n-Propyl alcohol	C3H8O	85
86	i-Propyl alcohol	C3H8O	86
87	Propylene	C3H6	87
88	Propylenedichloride-1.2	C3H6Cl2	88
89	Oxygen	O2	O2
90	Sulfur dioxide	SO2	SO2
91	Sulfurhexafluoride	SF6	91
92	Hydrogen sulfide	H2S	H2S
93	Town gas	CO, CH4, H2	93
94	Nitrogen dioxide	NO2	no2
95	Nitrogen monoxide	NO	no
96	Styrene	C8H8	96
97	Tetrachloroethane	C2Cl4	97
98	Toluene	C7H8	98
99	1.1.1-Trichloroethane	C2H3Cl3	99
100	Trichloroethylene	C2HCl3	100
101	Trifluoromethane (R23)	CH F3	101
102	Vinyl acetate	C4H6O2	102
103	Vinyl chloride	C2H3Cl	103
104	Hydrogen	H2	H2
105	Water gas	H2, CO, CH4	105
106	Xylene	C8H10	106
107	Ozone	O3	107

Chart 1 - GfG-Gas List

Terminal Plan - GMA41

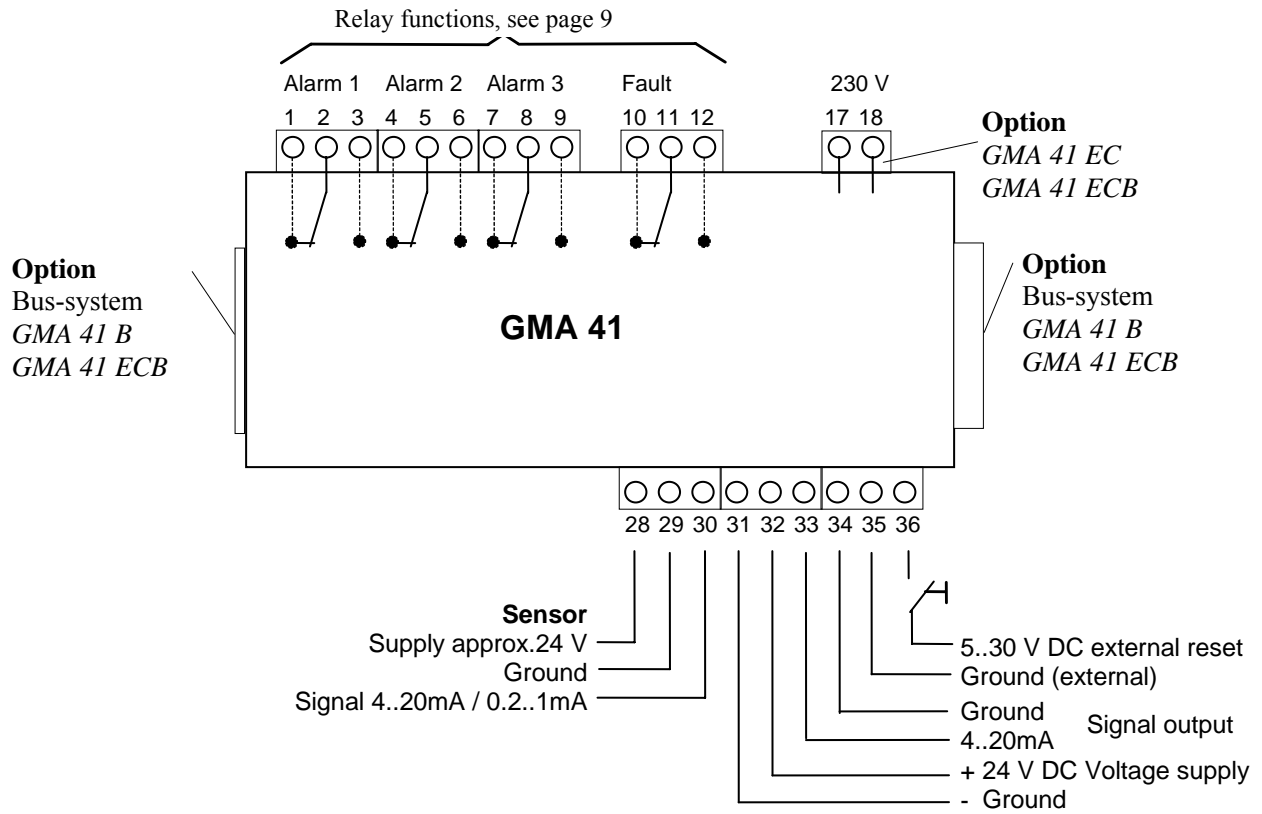

Technical Data

Gas Monitor GMA41	for mounting on DIN rail	
Type:	GMA41, Software version 2.03	
Dimensions:	106 x 90 x 58 mm (WxHxD), without Bus-system	
Power supply		
Operational voltage:	<i>GMA41, GMA41B</i>	24 V DC
	<i>GMA41 EC, GMA41 ECB</i>	230 V / 50Hz or 115 V / 60 Hz or 24 V DC
Current consumption:	max. 150 mA at 24 V DC max. 2.6 W at 230 V and 115 V	
Primary fuse:	<i>GMA41 EC, GMA41 ECB</i>	T 0.08 A
Secondary fuse:	<i>GMA41 EC, GMA41 ECB</i>	T 0.50 A
Climate Conditions		
for operation:	0 to +55 °C, 0 to 99 % r.h., 700 to 1300 hPa 0 to +40 °C with built-in mains unit (<i>GMA41 EC(#)</i> and <i>GMA41 ECB (#)</i>)	
recommended storage conditions for GMA41, accessories, spares:	-25 to +50 °C, 0 to 99 % r.h.	
Transmitter connection		
Transmitter connection:	2-, 3-wire transmitter	
Voltage supply output:	20 V DC max. 250 mA	
Input signals:	4 .. 20 mA, 0.2 .. 1 mA	
Output signals		
Analog outputs for meas. value:	4 .. 20 mA, max. load 300 Ω (T90 = 18 seconds)	
Display and activation of alarm	T 90 < 3 seconds	
Sensor signal display:	0.12 .. 1 mA Max. deviation:	< 0,2 mA ± 0,04 mA 0.2 .. 0.5 mA ± 0.02 mA > 0.5 mA + 0.05 mA
	2,4 .. 20 mA Max. deviation:	< 4 mA ± 0,8 mA 4 .. 10 mA ± 0.4 mA > 10 mA + 1 mA
Relays:	max. switch voltage 250 V AC 50/60 Hz or 250 V DC max. switch current 4 A AC/DC max. switch performance 1000 VA AC or depending on voltage 50 .. 200 W DC Relay outputs and mains entry are operation insulated	
Logical outputs	4 open collector outputs for alarm 1, alarm 2, alarm 3, fault Operation only on safety low voltage Max. switch voltage: 30 V Max. switch current: 100 mA	
External reset:	High active from 3 .. 24 V DC (input resistance 11kΩ)	
DIN rail mounting:	DIN EN 50022	
Safety		
Protection:	DIN 40050 - IP -20	
Protective separation:	by safety transformer	
<i>GMA41 EC, GMA41 ECB</i>	Type: BV EI 306 2064	2.6VA PRI 230V / SEC 18 V 50 - 60Hz
Protective insulation:	as per EN 61010 up to over voltage category III and soiling degree 2	
Tests		
EMV Test	according EN 50270: 1999 type 2 EN 50054: 1998	
Function test	Deutsche Montan Technologie GmbH (DMT) PFG-No. 41300500 (tested detection range: see page 3)	

Applicational Hints from test report PFG-No. 41300500

The controller GMA 41 (Versions GMA 41 and GMA 41 B), produced by Gesellschaft für Gerätebau mbH, Dortmund, is, if operated with transmitter CC 0238 Ex or transmitter with 0.2 .. 1 mA or 4 .. 20 mA signal output, based on the measurement results and remarks of test report PFG-No. 41300500P, suitable for detecting methane, propane, ethanol and n-nonane in a gas-air mixture in the detection range 0 .. 100 % LEL, if its characteristics and its version complies with the documentation specified in the test report PFG-No. 41300500P, if it is operated properly and if the following points are adhered to:

- The controller is only allowed to operate with transmitters with signal output 0.2 .. 1 mA, resp. 4 .. 20 mA, which have been function tested by an acknowledged testing authority . The applicational hints of the respective aptitude test report, respectively the conditions of the safety report are to be complied with.
- The operation manual given to and tested by PFG is to be adhered to in all details. When operating the gas detector, make sure that the specific operational conditions are met.
- Before using the gas detector please check, if the response times are short enough to trigger the alarm so quickly, that hazardous situations will be avoided. If necessary, the alarm thresholds are to be set to a considerably lower concentration than standard.
- The information sheet T 023 of the “Bundesgenossenschaft der chemischen Industrie (4)” (confederation of the chemical industry) is to be complied with.
- For correct use as a warning instrument for explosive atmosphere the current nationwide accepted value for the LEL is to be used (5), (6).
- For triggering of safety controls only latching alarms may be used, which cannot be reset during alarm conditions. The alarm A3 may only be used for additional external alarm devices, like horns.
- Is the device exposed to vibrations one has to reckon with short-term fault reports on the relay outputs.
- Fault warnings and alarms have to be displayed (e.g. as collective alarm) audibly and visibly on a 24-hour occupied place.
- The controllers are to carry a durable type label, which gives information about the manufacturer, type and the serial number and is marked with:
“PFG-Nr. 41300500”
Other regulations for marks, particularly as per ExV are untouched. With this type label the manufacturer confirms, that the controllers comply with the characteristics and the technical specifications described in this report. Any controller not carrying this type label does not comply with the present report.
- On request, a complete printout of this report and of the test report PFG-No. 41300500P is at the user’s disposal.

Annex

The mains units mentioned in the annex are not subject to the function test PFG.

Selection of the proper Mains Unit for GMA41 Configurations

Depending on the requested monitor configuration you have to select a mains unit from a choice of three performance classes.

1. Select your specific monitor configuration (type and quantity of controllers and transmitters).
2. Add the individual current consumptions of the controllers and transmitters.
3. Compare the result with the chart below and select the suitable mains unit.

Please note:

- Only the following transmitters can be attached to a GMA41 EC, 41 ECB and 44 EC, 44 ECB: Transmitter EC24 or EC25.
- Only transmitters of the same type and for the same gas can be attached to a GMA 44.
- **If a GMA 44 is used, always select mains unit PS 50 (or higher)**
- To keep the voltage reduction resulting from the combination of several controllers (≥ 6) as low as possible, make sure that the voltage supply is suitably fed.

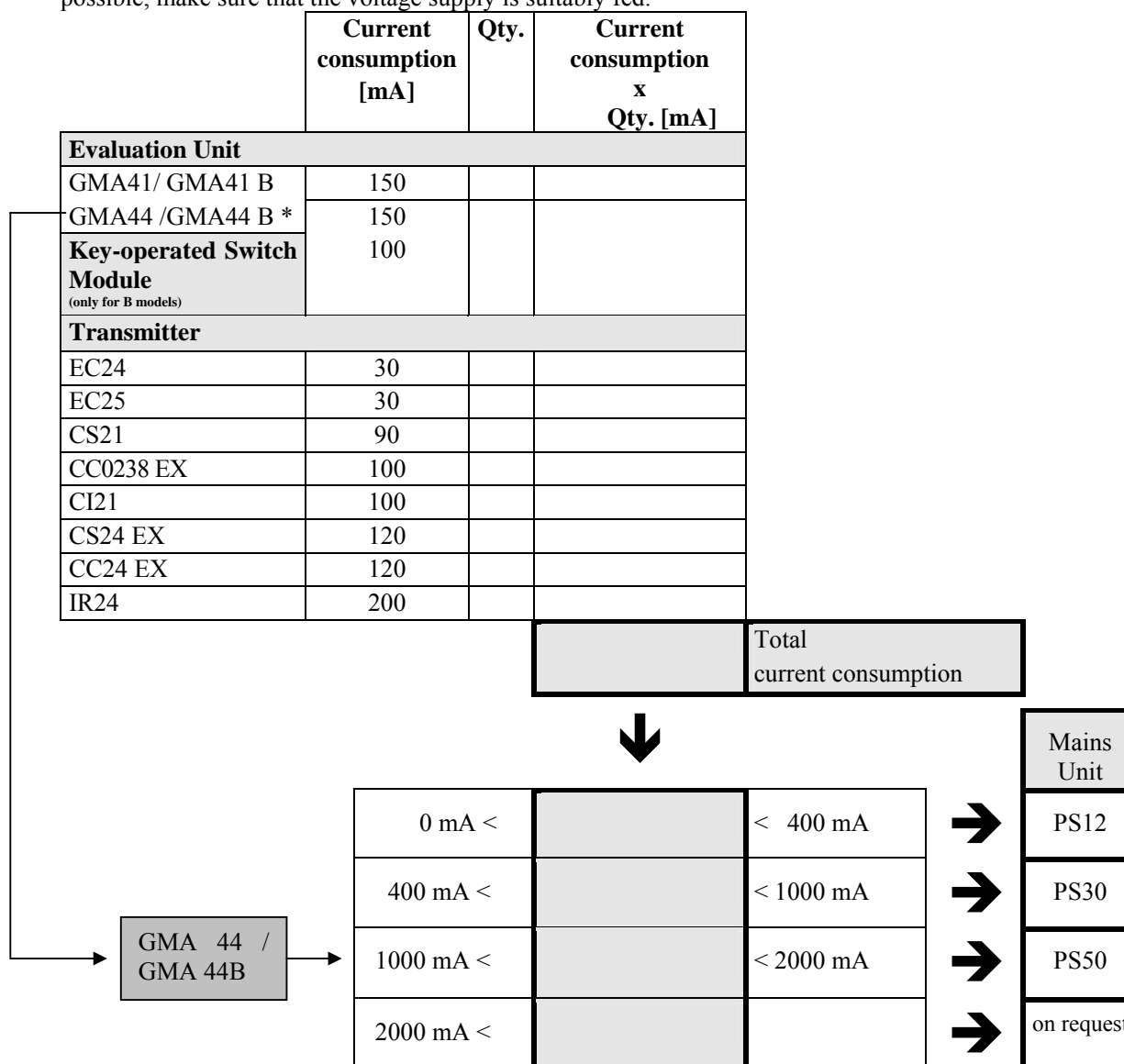

* GMA 44 / GMA 44B requires mains unit PS 50 or higher.

Connection Diagram of Mains Units

GMA 41 Terminals

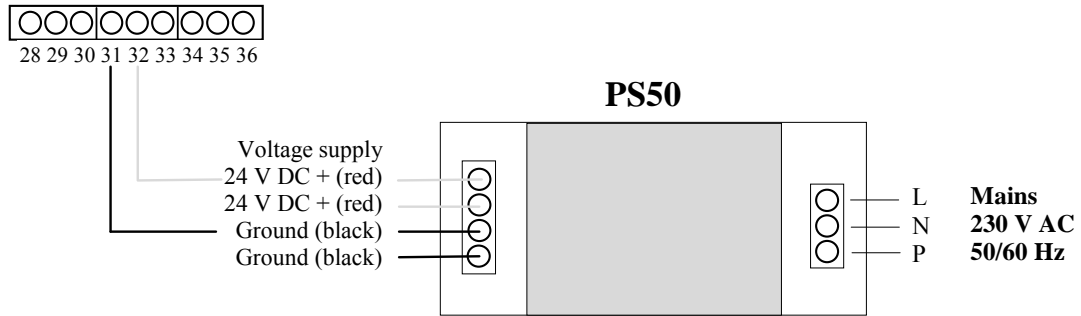

The mains unit PS 50 comes complete with 2 x 0.5 m cable *red* and 2 x 0.5 m cable *black*, so the supply can be effected at two places.

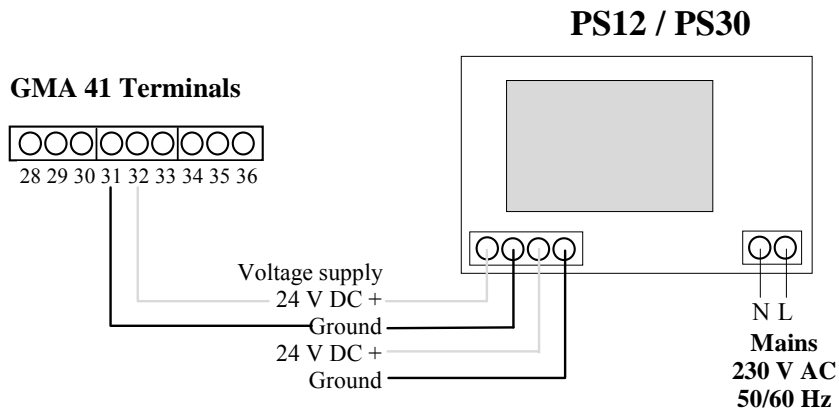

As the PS 50, the mains units PS12 and PS30 also allow the supply to be effected at two or more places.

Technical Data of Mains Units

Type	PS12	PS30	PS50
	Mains units (not stabilized)		Stabilized control mains unit
Dimensions (WxHxD):	106 x 76 x 64 mm	106 x 76 x 85 mm	225 x 65 x 43.5 mm
Weight:	445 g	898 g	464 g
Input			
Primary voltage:	230 V / 50Hz		
Primary fuse:	T 0.08 A G	T 0.315A G	
Output			
Secondary voltage	30 .. 21 V	27 .. 20 V	24 V
Secondary current	0 .. 400 mA	0 .. 1000 mA	0 .. 2000 mA
Power:	8.4 VA	20 VA	48 VA
Secondary fuse:	T 0.50 A	T 1.00 A	internal overload protection
Climate Conditions			
for operation:	-10 ... +55 °C / 0 ... 99 % r.h. / 700 ... 1300 hPa		-10 ... +55 °C / 20 ... 90 % r.h. / 700 ... 1300 hPa
Recommended storage conditions:	0 ... 30 °C, 20 ... 80 % r.h.		
DIN rail mounting:	DIN EN 50022		
Safety			
Protection:	DIN 40050 – IP –20		
Protective separation:	By means of safety transformer EI 48 V11419 12.0VA EI 60 V11505 30.0VA PRI 230V / SEC 20 V PRI 230V / SEC 21 V 50 - 60Hz 50 - 60 Hz		
Protective insulation.	As per EN 61010 up to overvoltage category III and soiling degree 2		
Safety standards:	DIN EN 61558		UL 1950 EN 60950 VDE 0160

Terminal Diagram of Transmitters

Transmitter CC0238 EX

The CC sensor is designed as a 3-wire transmitter. The supply voltage and the 0.2 - 1 mA output signal use the same ground line. Cable type: e.g. LiYCY 3 x 0.75 mm² (up to 200 m).

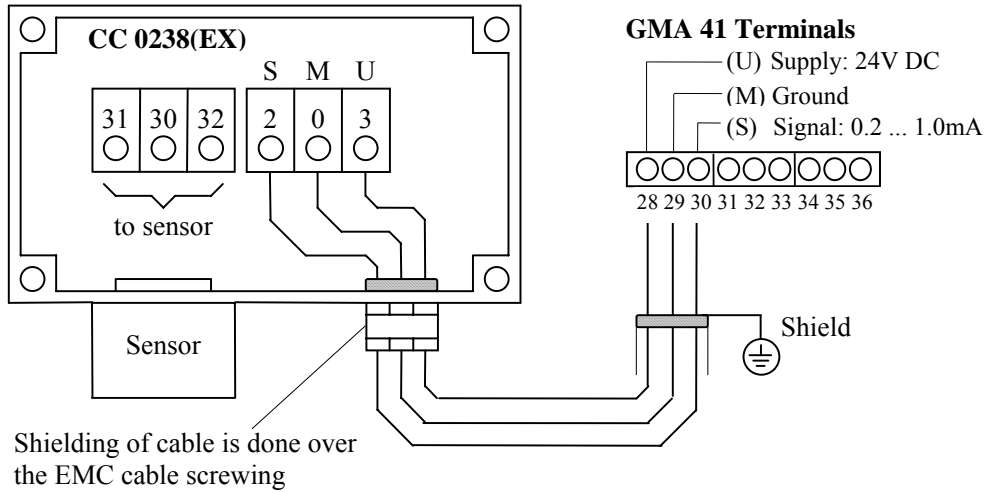

Transmitter CS21 and CI21

These sensors are designed as 3-wire transmitters.

0.2 – 1 mA output signal

The supply voltage and the 0.2 – 1 mA output signal use the same ground line. Cable type: e.g. LiYCY 3 x 0.75 mm² (up to 200m)

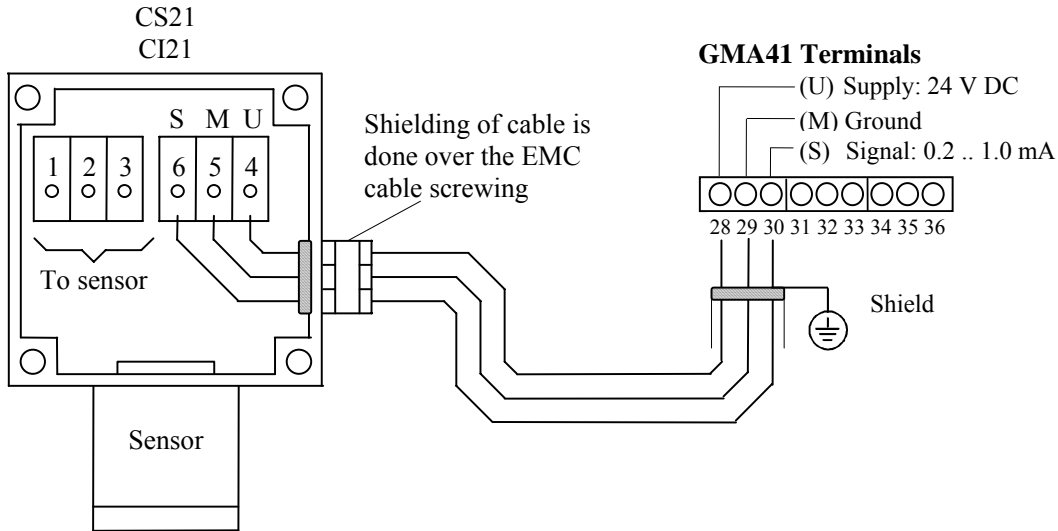

4 – 20 mA output signal

The supply voltage and the 4 – 20 mA output signal use the same ground line.

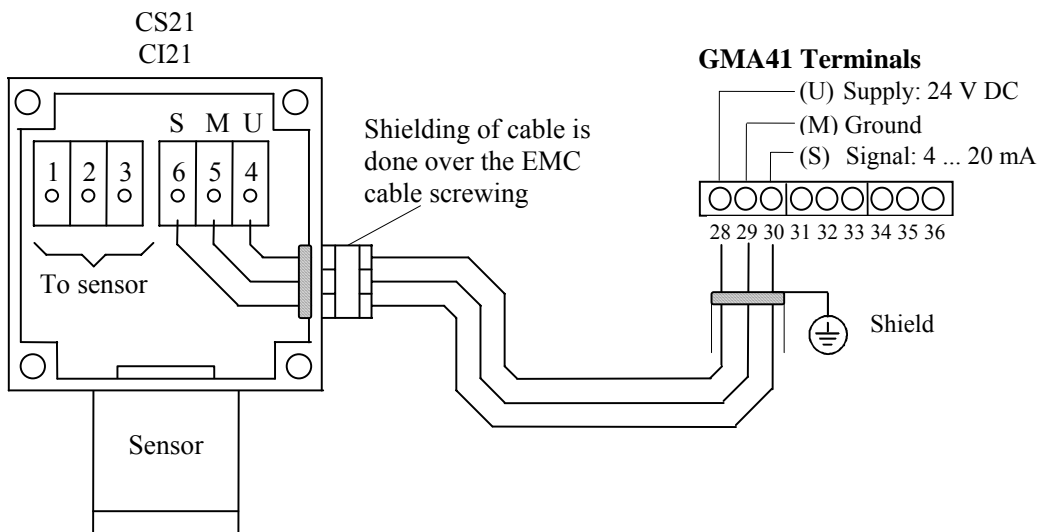

Transmitter EC24 (models MWG 2412, 2414, 2411 and 2413)

4 – 20 mA output signal

The EC models MWG 2412 and MWG 2414 are designed as 2-wire transmitters. The 4 – 20 mA output signal is provided via the supply line.

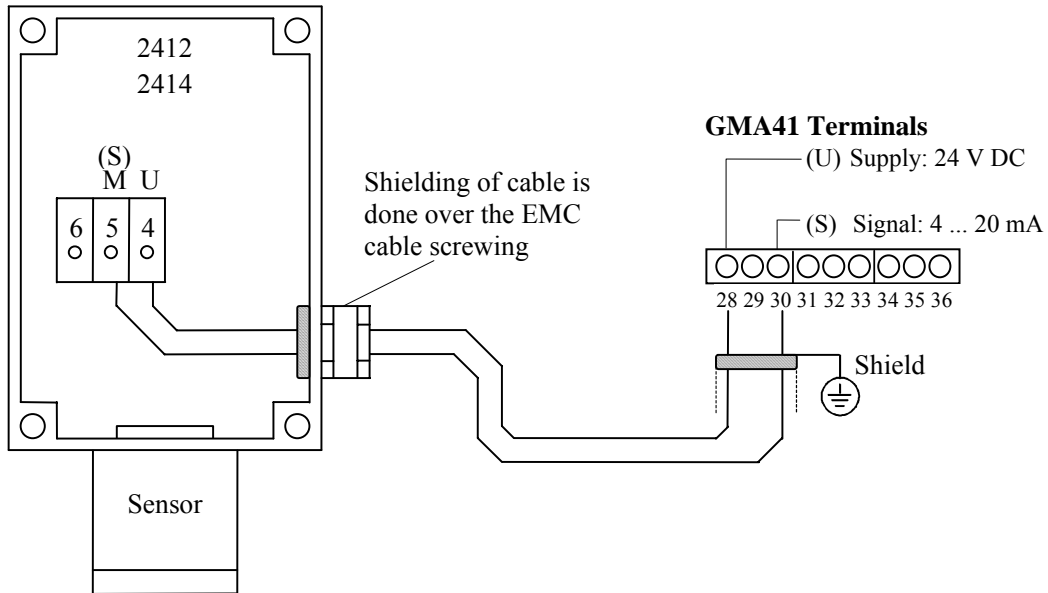

0.2 – 1 mA output signal

The EC models MWG 2411 and MWG 2413 are designed as 3-wire transmitters. The supply voltage and the 0.2 – 1 mA output signal use the same ground line.

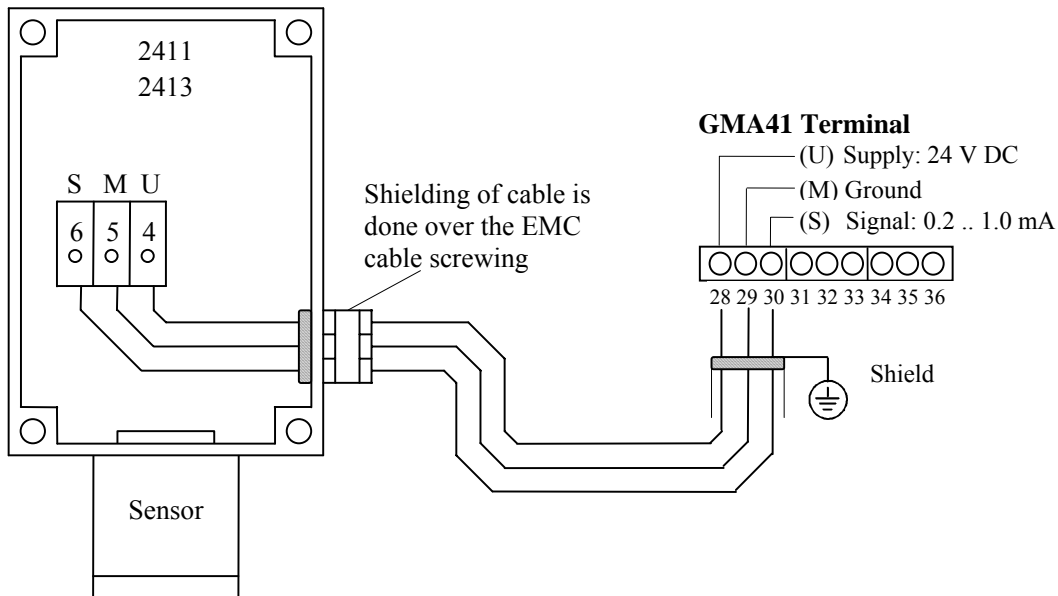

Transmitter CC24 EX (models MWG 2431 and 2432)

Transmitter CS24 EX (models MWG 2471 and 2472)

Transmitter IR 24 (models MWG 2491 and 2492)

0.2 – 1 mA output signal

The Transmitters CC model MWG 2431, the CS model MWG 2471 and the infrared transmitter MWG 2491 are designed as 3-wire transmitters. The supply voltage and the 0.2 - 1mA output signal use the same ground line.

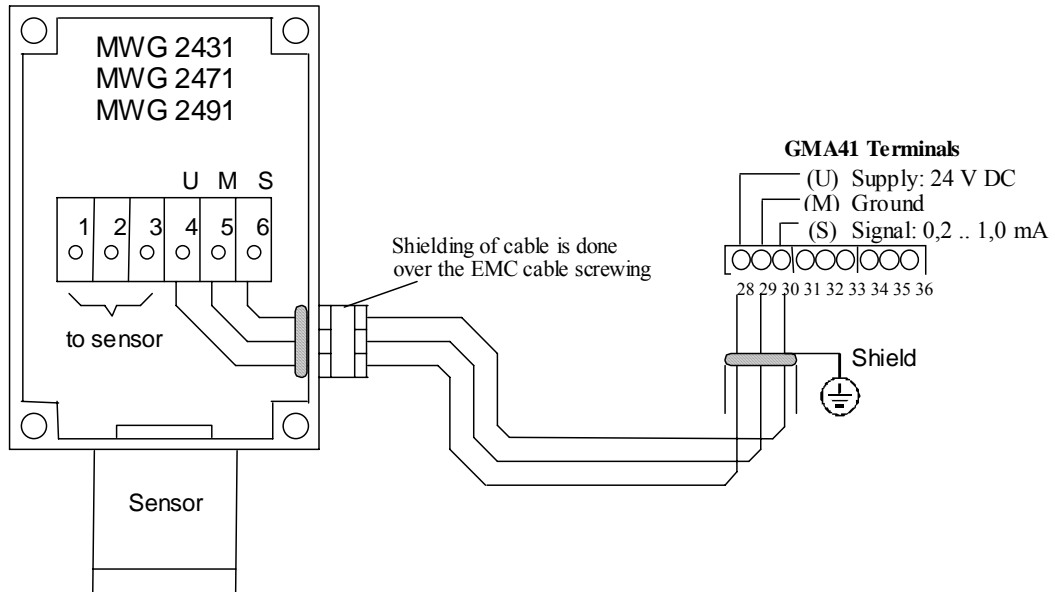

4 – 20 mA output signal

The CC model MWG 2432, the CS model MWG 2472 and the infrared transmitter MWG 2492 are designed as 3-wire transmitters. The supply voltage and the 4 – 20 mA output signal use the same ground line.

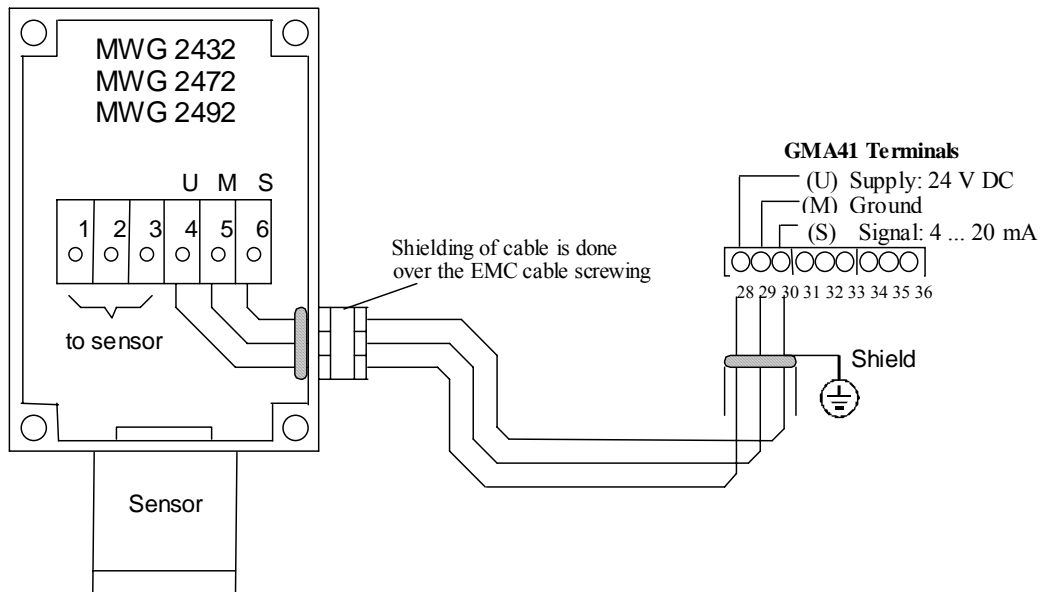

Transmitter EC25 (models MWG 2502, 2504, 2501 and 2503) without Ex-barrier

4 - 20 mA output signal

The EC models MWG 2502 and MWG 2504 are designed as 2-wire transmitters. The 4 – 20 mA output signal is provided via the supply line.

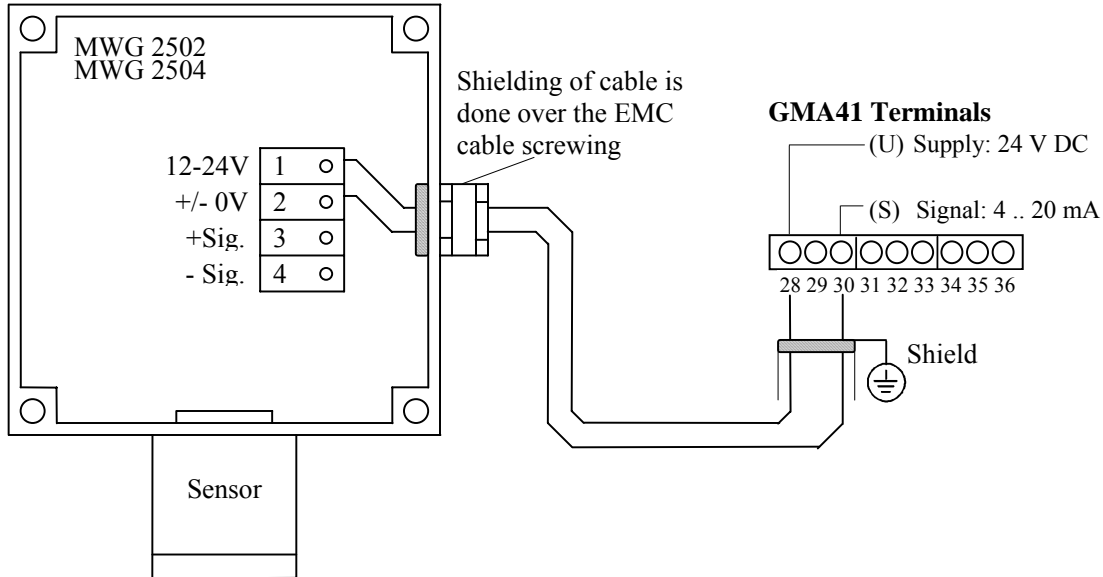

0.2 – 1 mA output signal

The EC models MWG 2501 and MWG 2503 are designed as 3-wire transmitters. The supply voltage and the 0.2 – 1 mA output signal use the same ground line.

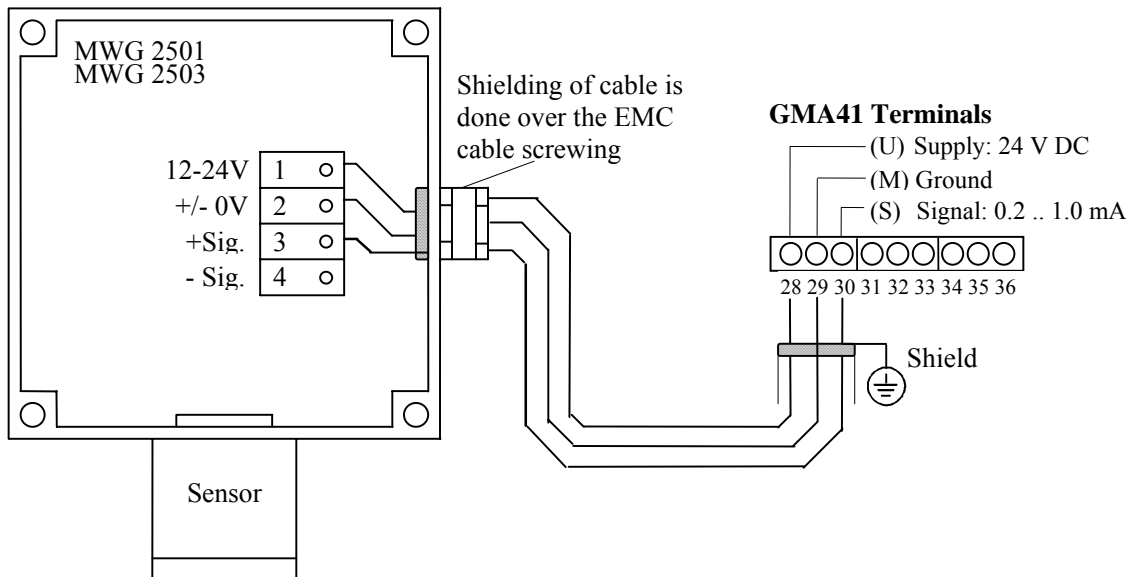

**Worldwide Supplier of Gas Detection
Solutions**



GfG Instrumentation
1194 Oak Valley Drive, Suite 20
Ann Arbor, MI 48108
800-959-0329 tel
734-769-1888 fax
email: info@gfg-inc.com

File: GMA41-7-28-06, Edition 26, July 2006

GfG reserves the right of modification