

Builder's Tools / Woodworking



**Drill
Accessories
Circle
Cutters
Countersinks
Drill
Bits
Gages
Layout
Tools
Compasses
Calipers
Squares
Trammels
Scratch
Awls
Moisture
Meters**



E-Z Pro WOOD JOINING



WOODWORKING

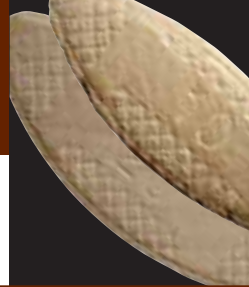

General's NEW Wood Joining Program features all the necessary pieces for . . . WOOD JOINING! Included in this program are: Fluted Dowel Pins, Dowel Plugs, Shaker Pegs, Biscuits and Pocket Hole Accessories.

All of these items are used to create panels in the creation of furniture, cabinets, trim, crafts and much more. Also included in this program are the wood joining jigs, screws and drill bits.

WOODWORKING

Wood Joining Product Line			D34WJ		
UPC	NO.	DESCRIPTION	UPC	NO.	DESCRIPTION
†00031 7	841	E-Z Pro™ Doweling Jig Kit (1)	02112 0	314038	3/8" Round Head Plugs, Oak (3)
†00001 0	846	E-Z Pro™ Jointer Clamp Kit (1)	02116 8	316038	3/8" Round Head Plugs, Birch (3)
†00051 5	849	E-Z Pro™ Pocket Hole Jig Kit (1)	02117 5	316012	1/2" Round Head Plugs, Birch (3)
02124 3	860	E-Z Pro™ Dovetail Jig Kit (1)	02118 2	317000	Shaker Pegs (3)
02101 4	840014	1/4" Fluted Dowel Pins (3)	02119 9	841014	1/4" Dowel Accessory Kit (2)
02102 1	840516	5/16" Fluted Dowel Pins (3)	02120 5	841516	5/16" Dowel Accessory Kit (2)
02103 8	840038	3/8" Fluted Dowel Pins (3)	02121 2	841038	3/8" Dowel Accessory Kit (2)
02104 5	840012	1/2" Fluted Dowel Pins (3)	08401 9	8401	Dowel Accessory Kit (2)
02109 0	313038	3/8" Flat Head Plugs, Oak (3)	02123 6	8495	Pocket Hole Plugs, Birch (3)
02110 6	313012	1/2" Flat Head Plugs, Oak (3)	08497 2	8497	Pocket Hole Screws, Coarse (2)
02113 7	315516	5/16" Flat Head Plugs, Birch (3)	08498 9	8498	Pocket Hole Screws, Fine (2)
02114 4	315038	3/8" Flat Head Plugs, Birch (3)	02122 9	8492	2 Square Drive Bits (2)
02115 1	315012	1/2" Flat Head Plugs, Birch (3)	†00052 2	32	Step Drill Bit (2)
02105 2	311038	3/8" Button Plugs, Oak (3)	23096 6	S838	6 Pc Drill Stop Set (2)
02106 9	311012	1/2" Button Plugs, Oak (3)	23041 6	34ST	4 Pc Pilot Drill Set (2)
02107 6	312038	3/8" Button Plugs, Birch (3)	23024 9	31A	3/8" Plug Cutter (2)
02108 3	312012	1/2" Button Plugs, Birch (3)	23036 2	S31	3 Pc Plug Cutter Set (2)





General Mfg UPC #038728
†General Mfg UPC #708200

Size: 28 x 40 (Quantity indicated in parenthesis)



All wood pieces in our program are manufactured in accordance with certification by the FSC (Forest Stewardship Council). The goal of the FSC (Forest Stewardship Council) is to promote environmentally responsible, socially beneficial and economically viable management of the world's forests.



FLUTED DOWEL PINS & DOWEL ACCESSORY KITS	DOWEL PLUGS	SHAKER PEGS	BISCUITS	POCKET HOLE ACCESSORIES
 <p>Used for: Wood joinery (furniture, cabinets, trim, crafts). Fluted design offers quick glue dispersion and increases bonding strength.</p> <p>Dowel Accessory Kits: Available for 1/4", 5/16" and 3/8" doweling projects and include dowels, drill bit, drill stop and center point. E-Z Dowel Kit No. 8401 Includes: 1/4", 5/16" and 5/8" dowels, drill bits, drill stops and center points.</p>	 <p>Used for: Covering screws for a finished appearance. Available in 3 styles: • Button, Round and Flat in 2 finishes: Birch and Oak</p>	 <p>Used for: Coat and Hat Racks, Crafts and Decorations. Shaker Pegs can be painted or stained.</p>	 <p>Used for: Wood Joinery with Biscuit Joiners. Great for furniture, cabinets and trim. Biscuits soak up water-based glue for a tighter wood joint. No. 318000 – size #0 No. 318010 – size #10 No. 318020 – size #20 No. 318050 – size FF</p>	 <p>Used for: Making pocket hole joints. • Step drill • Square drive bits • Plugs and screws</p>

Wood Joining

General's NEW Wood Joining Program features all the necessary pieces for . . . WOOD JOINING! Included in this program are: Fluted Dowel Pins, Dowel Plugs, Shaker Pegs, Biscuits and Pocket Hole Accessories.

All of these items are used to create panels in the creation of furniture, cabinets, trim, crafts and much more. Also included in this program are the wood joining jigs, screws and drill bits.

WOODWORKING



Wood Joining Planogram (small) D21WJ

UPC	NO.	DESCRIPTION
†00031 7	841	E-Z Pro™ Doweling Jig Kit (1)
†00051 5	849	E-Z Pro™ Pocket Hole Jig Kit (1)
02124 3	860	E-Z Pro™ Dovetail Jig Kit (1)
02101 4	840014	1/4" Fluted Dowel Pins (3)
02102 1	840516	5/16" Fluted Dowel Pins (3)
02103 8	840038	3/8" Fluted Dowel Pins (3)
02109 0	313038	3/8" Flat Head Plugs, Oak (3)
02110 6	313012	1/2" Flat Head Plugs, Oak (3)
02113 7	315516	5/16" Flat Head Plugs, Birch (3)
02114 4	315038	3/8" Flat Head Plugs, Birch (3)
02115 1	315012	1/2" Flat Head Plugs, Birch (3)
02105 2	311038	3/8" Button Plugs, Oak (3)
02106 9	311012	1/2" Button Plugs, Oak (3)
02107 6	312038	3/8" Button Plugs, Birch (3)
02108 3	312012	1/2" Button Plugs, Oak (3)
02112 0	314038	3/8" Round Head Plugs, Oak (3)
02116 8	316038	3/8" Round Head Plugs, Birch (3)
02117 5	316012	1/2" Round Head Plugs, Birch (3)
02118 2	317000	Shaker Pegs (3)
08497 2	8497	Pocket Hole Screws, Coarse (2)
†00052 2	32	Step Drill Bit (2)

Size: 28 x 22 (Quantity indicated in parenthesis)

THE DOVETAILER™

DOVETAIL JIG

E-Z Pro™ DOVETAIL JIG KIT

With the Dovetailer™ and your router, you can cut Professional Dovetail Joints, Simply and Accurately . . . Right Out Of The Box!

- Self-aligning design ensures that both ends of the dovetail joint match up evenly every time
- Portable to your work site or work area
- Sturdy machined aluminum construction
- Easily adjust the dovetail interference to create loose or tight joints
- No need to bolt the jig onto workbench like many other expensive Dovetail Jigs
- You bring the jig to the work piece, not the work piece to the jig
- Integrated clamps allow precise clamping of jig to work piece
- Accommodates boards of any widths
- Includes: 1/2" Dovetail Router bit, User's Manual

UPC	NO.
02124 3	860



"The Easy Way to Make Professional Furniture Joints"



Patent Pending 860



E-Z Pro

Cut Dovetail Joints with Your Router!

THE DOVETAILER™ DOVETAILED JIG



No. 860

CAN BE USED WITH ALL HANDHELD ROUTERS AND ALL ROUTER TABLES

With THE DOVETAILER™ Jig and your router, you can cut professional Through or Half Blind Dovetail Joints, simply and accurately . . . **Right Out of the Box!**

- Accommodates boards of any width
- Includes 1/2" Dovetail Router Bit, Instructional CD and User's Manual



1/2" Dovetail Router Bit included



Cuts Through Joints



Cuts Half-Blind Joints

EASY TO USE FOR THE BEGINNER AND THE PROFESSIONAL

- Self-aligning design ensures that both ends of the dovetail joint match up evenly every time
- Portable to your work site or work area
- Sturdy machined aluminum construction
- Easily adjust the dovetail interference to create loose or tight joints
- No need to bolt the jig onto workbench like many other expensive Dovetail Jigs
- You bring the jig to the work piece, not the work piece to the jig
- Integrated clamps allow precise clamping of jig to work piece
- Can be used with all handheld Routers or Router Tables

The Easy Way to Make Professional Furniture Joints



©2010 General Tools & Instruments

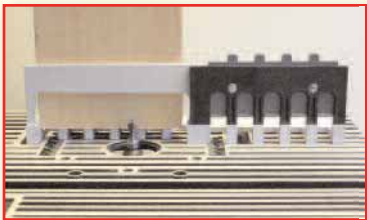

Patent Pending

Wood Joinery

Pocket-Hole Joints are sturdy and simple to make with a driving jig. By drilling steeply pitched counter bores in one joint member, you can drive self-

tapping screws into the other without pilot holes. Ideal for leg and rail connections and cabinet construction.

WOODWORKING

AWARD WINNER

Popular Mechanics
EDITOR'S CHOICE AWARD 2007

E•Z Pro[™] POCKET HOLE JIG KIT

- Pocket hole joints are sturdy and simple to make with a drilling jig
- By drilling steeply pitched counterbores in one joint member, you can drive self-tapping screws into the other without pilot holes
- The joints are ideal for leg-and-rail connections, cabinet construction, sneaking screws into tight-squeeze spots or fastening picture frame miters
- Heavy-duty aluminum extrusion and hardened steel drill bushings
- Built to be portable or bench mounted and designed with a clamping system built in
- Kit includes: 1 Pocket Hole Jig with Clamps; 3/8" Step Drill Bit; 1 3/8" Drill Stop and Hex Wrench; 6" Steel Square Drive Bit; Square Drive Screws, Instructions

UPC	NO.
708200000515	849



849



Patent No. 6,254,320



Photos property of Woodworker's Journal

E•Z[™] STEP DRILL BIT

- Replacement bit for General's E•Z Pocket Hole Jig Kit (No. 849)
- 3/8" x 6" (9.5 x 152mm) step drill bit
- High speed steel
- Ideal for creating pocket hole joints and counter-boring
- Includes 3/8" (9.5mm) steel drill stops with hex wrench

UPC	NO.
708200000522	32



32

POCKET HOLE SCREWS

- Self-tapping
- Use a coarse thread screw in soft material
- Use a fine thread screw in hardwoods
- Nickel-plated
- Pan Head
- Size: 1-1/4"

UPC	NO.	Thread	Count/pkg
08497 2	8497	Coarse	100
08498 9	8498	Fine	100

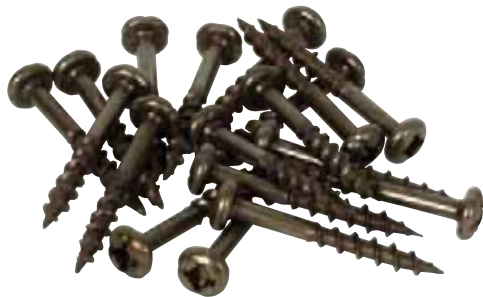

8497



No. 8497 shown
actual size of 1-1/4"





General Tools now offers replacement and accessory parts for their new line of Drill and Wood Joining Jigs. The No. 32 Replacement Step Drill Bit is used with the No. 849 Pocket Hole Jig. No. 8401, Dowel Accessory

Kit, can be used for both the No. 840 and No. 841 doweling jigs. No's. 8497 and 8498 are Pocket Hole Screws used specifically for pocket hole wood joinery. Offered in both fine and coarse thread.

E•Z Pro[™] DOWELING JIG KIT

- Dowels add mechanical strength to butt joints and keep miters lined up during clamping
- The pointed notches on the working edges of our jig centers the drill bit automatically for precise registration
- Indicate a thin layout mark across the joint where you want the dowel to be and registering the drill bit is easy

- Create 3 types of dowel joints: Edge to edge, right angle, edge to surface, as well as 3 sizes of dowel joints; 1/4", 5/16" and 3/8"
- Ideal for 5/8", 3/4" and 1" thick stock
- Kit includes: 1 Dowel Jig; 3 Brad Point Drill Bits; 1/4", 5/16", 3/8"; 3 steel stops 1/4", 5/16" and 3/8" with Hex Wrench, 6 Dowel Center Points; 2 each of 1/4", 5/16" 3/8", supply of wood dowels, Instructions

UPC	NO.
708200000317	841



Patent No. 7,001,118

Photos property of Woodworker's Journal



841

E•Z[™] DOWEL ACCESSORY KIT

- Replacement bit for General's E•Z Pocket Hole Jig Kit (No. 849)
- Accessories Kit for General's Pro Doweling Kit (No. 840) and E•Z Dowel Kit (No. 841)
- For 1/4", 5/16", 3/8"
- Kit includes
 - 3 Brad Point Drill Bits 1/4", 5/16", 3/8",
 - 6 Dowel and Tenon Centers from 3/16" ID to 1/2" OD,
 - 3 Drill Stops 1/4", 5/16", 3/8",
 - 30 Dowel Pins, 10 each 1/4", 5/16", 3/8" hex wrench

UPC	NO.	
08401 9	8401	
02101 4	840014	1/4" Fluted Dowel Pins
02102 1	840516	5/16" Fluted Dowel Pins
02103 8	840038	3/8" Fluted Dowel Pins



8401

WOODWORKING

Wood Joining & Drill Accessories

General Tools now offers replacement and accessory parts for their new line of Drill and Wood Joining Jigs. The No. 32 Replacement Step Drill Bit is used with the No. 849 Pocket Hole Jig. No. 8401, Dowel Accessory

Kit, can be used for both the No. 840 and No. 841 doweling jigs. No's. 8497 and 8498 are Pocket Hole Screws used specifically for pocket hole wood joinery. Offered in both fine and coarse thread.

WOODWORKING



846

E-Z Pro™ TRU-EDGER™ JOINTER CLAMP

- The long awaited alternative to expensive jointers!
- Straight line rip crooked boards on your table saw
- Just mount the clamps to a guide board to create a flat reference edge
- The guide board can be made from any straight edged scrap
- Clamp the stock to the guide board and make your rip cut
- Get a dead-flat edge every time, with no extra waste
- The jointer clamps work on any length stock up to 2" thick
- Instructions included

UPC	NO.	Capacity
708200000010	846	2" stock



New Swing Arm



Photos property of Woodworker's Journal

Patent No. 7,000,519

DOWEL PINS

- General's dowel centers are the quickest and most accurate method to locate, transfer and match dowel holes
- Made of nickel plated steel

- Set includes 8 pcs., two of each size: 1/4", 5/16", 3/8", 1/2" diameter

UPC	NO.	
25099 5	888	Dowel centers



888

DRILL STOP SET

- For use on twist or brad point drills to prevent excessive drill penetration
- Positive depth control assures exact hole depths for multiple drilling jobs
- Black oxide finish on cold rolled steel

- Includes hex wrench

UPC	NO.	SIZES INCLUDED
23096 6	8838	3/16" dia., 1/4" dia., 5/16" dia., 3/8" dia., 7/16" dia., 1/2" dia.



8838



General's Doweling Jig is a precision jig that assures the accurate line-up of dowel holes in furniture and carpentry. Simply clamp the jig onto your workpiece to quickly and accurately drill holes for dowel pins

requiring exact alignment in the edge, end or surface of your work. General's Drill Grinding Attachment is engineered to permit the sharpening of drill bits to factory accuracy.

PRO DOWELING KIT

- A precision jig that assures accurate line up of dowel holes in furniture and carpentry
- Revolving turret has six twist drill sizes
- Just lift and turn turret to lock in guide hole
- Black oxide guide bars are graduated for fast positioning of hole center points
- Clamp screw locks tool onto work from 0" to 4" in width
- Hardened sintered turret for durability
- Package Contents: 1 Doweling Jig; 3 Brad Point Drill Bits, 1/4", 5/16", 3/8"; Dowel and Tenon Centers Set from 3/16" ID to 1/2" OD; 3 Drill Stops, 1/4", 5/16", 3/8"; 30 Dowel Pins, 10 Each 1/4", 5/16", 3/8"; Wood Glue
- Instructions included

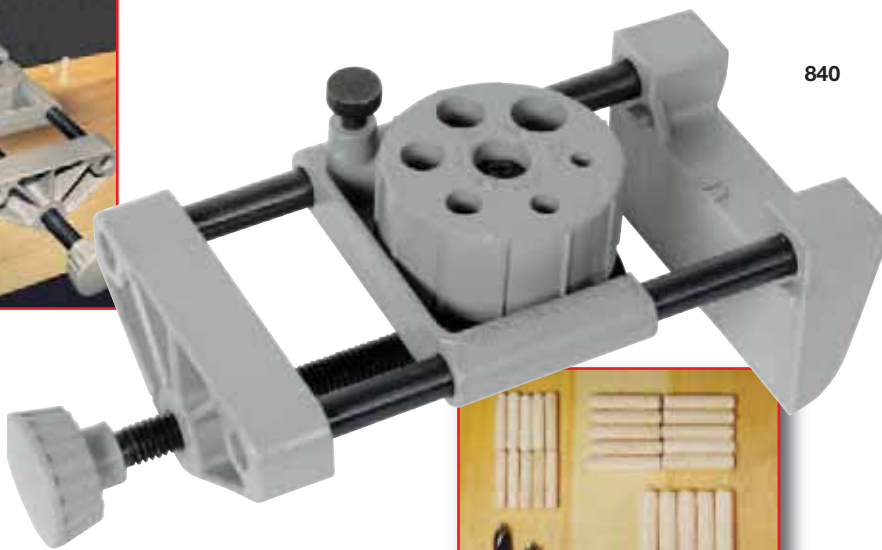

840

UPC	NO.	CAPACITY
24120 7	840	3/16", 1/4", 5/16", 3/8", 7/16", 1/2"



WOODWORKING

"ORIGINAL" DRILL GRINDING ATTACHMENT

- Engineered to permit sharpening of drill bits to factory accuracy
- Extends the life of drill bits
- Angle adjustments lock in to grind drill bits for more accurate drilling in a variety of materials
- Automatically adjusts to give correct clearance angle
- For use with ANSI, OSHA, and UL approved standard electric bench grinders or surface grinders
- Equally at home in machine shop and home workshop
- Instructions included

UPC	NO.	CAPACITY
24070 5	825	Fractional drills 1/8" to 3/4", Number size drills 30 to 1 Letter size drills A to Z, Millimeter size drills 3.0 to 19.0



825

Drill Accessories

General's Drill Accessories are engineered to do precision work in the many specialized drilling and cutting operations required for fine carpentry and metal working.

They expand the capabilities of portable electric drills, drill presses, drill stands, bit braces and hand drills. Our Drill Accessories are built for precision and durability.

WOODWORKING

PRECISION DRILL GUIDE

- Attaches to all 3/8" and 1/2" power drills
- Cross slide lock for accurate shaping and carving
- 3/8" capacity drill chuck with key
- Positive stop for accurate drill depth control
- Dual locking knob and handle holds precise angle setting
- Folds flat for tool box storage
- Easy-to-read protractor scale has 5° graduations (0° - 45° left or right)
- V-guides automatically center round stock for drilling
- Self centering channel for edge drilling

UPC	NO.
23059 1	36/37 Complete set



36/37

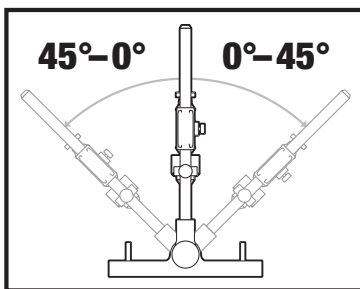

924

RIGHT ANGLE DRIVE

- Our Right Angle Drive reaches awkward corners and difficult angles easily; ideal for any close quarter drilling
- Designed for use with portable electric drills, sanding or buffing attachments and other drill accessories
- Plastic handle attaches for right or left-hand use
- Designed for long life, the drive body is strong die-cast zinc, with permanently lubricated steel gears
- 24-thread, 3/8" spindle has 3/8" drill chuck adapter
- Chucks not included

UPC	NO.
25115 2	924

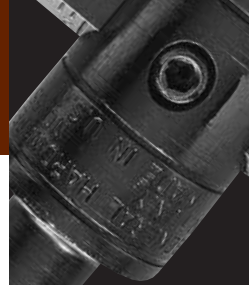

General's Circle Cutters produce precision circles in sheet metal, brass, copper, soft steel, aluminum, plastic, wood and composition materials. Bodies are constructed of heat treated tool steel for durability.

The replaceable cutter blades are made of high-speed steel for precise and clean cuts. Circle Cutters are adjustable for cutting various diameter holes. A hex wrench is included for adjustments.

4" MAX CIRCLE CUTTER

- Round shank circle cutter
- Replaceable high-speed steel cutting blade and replaceable 1/4" pilot drill
- All adjustments are made with a hex wrench which is included
- **Maximum safe speed is 500 RPM**
- **For use with drill press only**

UPC	NO.	CAPACITY	SHANK
21003 6	04	7/8" to 4"	3/8" Round
27006 1	4 Drill		
27003 0	4/5 Blade		

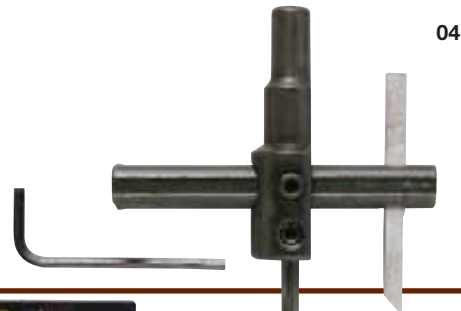

04

WHEEL AND CIRCLE CUTTER

- General's Wheel and Circle Cutter is the only one that cuts the exact diameter you need anywhere from 1" to 6" (26 to 152mm)
- Ideal for woodworkers, model builders, clockmakers, and hobbyists
- Produces precision circles and holes in sheet metal, brass, copper, aluminum, plastic, wood, and composition materials
- Change from circle to wheel cutting by simply reversing the double ended blade
- Sturdy round shank for use in any drill press or drill stand with 3/8" chuck

- Replaceable double ended 9/32" cutter blade is made of high-speed steel for precise clean cuts
- All adjustments are made with a hex wrench which is included
- **Maximum safe speed is 500 RPM**
- **For use with drill press only**

UPC	NO.	CAPACITY	SHANK
21010 4	06	1" to 6"	3/8" Round
21014 2	5/6/55 Drill		
21013 5	6 Blade		



06

6" MAX CIRCLE CUTTER

- Has been a General Tools customer favorite for more than 30 years
- Adjusts from 1" to 6" (26 to 152mm) diameter circles
- Replaceable high-speed steel blade and replaceable 1/4" pilot drill
- All adjustments are made with a hex wrench which is included
- **Maximum safe speed is 500 RPM**
- **For use with drill press only**

UPC	NO.	CAPACITY	SHANK
21009 8	5B	1" to 6"	3/8" Round
21014 2	5/6/55 Drill		
27003 0	4/5 Blade		

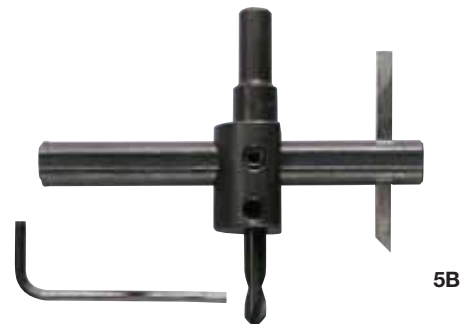

5B

HEAVY-DUTY CIRCLE CUTTER

- General's industrial quality cutter is most preferred by professionals
- 1/2" round shank for drill press use
- Replaceable high-speed tool steel blade and replaceable 1/4" pilot drill
- Markings on beam for easy measurement

- All adjustments are made with a hex wrench which is included
- **Maximum safe speed is 500 RPM**
- **For use with drill press only**

UPC	NO.	CAPACITY	SHANK
21012 8	55	1-3/4" to 7-7/8"	1/2" Round
21014 2	5/6/55 Drill		
27015 3	55 Blade		



55

WASHER AND GASKET CUTTER

- This tool cuts washers and gaskets in leather, rubber, cork, graphite, fiber, copper and other soft materials
- Combination round and square shank permits use with bit brace or hand drill
- Made of steel with graduated beam to adjust to diameters from 5/8" to 6-1/2" (16 to 165mm)
- Replaceable tool steel Cutter Blades No. 11B

- Two independently adjustable cutter blades cut inside and outside diameters simultaneously
- **Maximum safe speed is 100 RPM**
- **For hand powered drill only**

UPC	NO.	CAPACITY
21024 1	11	5/8" to 6-1/2"
27024 5	11B	Replacement blades (Pair)



11

Countersinks, Drill Bits, Gages

Pilot Bits drill, countersink and counterbore precision screw holes in a single operation. Self-Centering Hinge Bits drill highly accurate pilot holes in cabinet and door hinges.

Plug Cutters cut plugs for covering screw holes for decking, flooring and other fine woodworking projects.

WOODWORKING

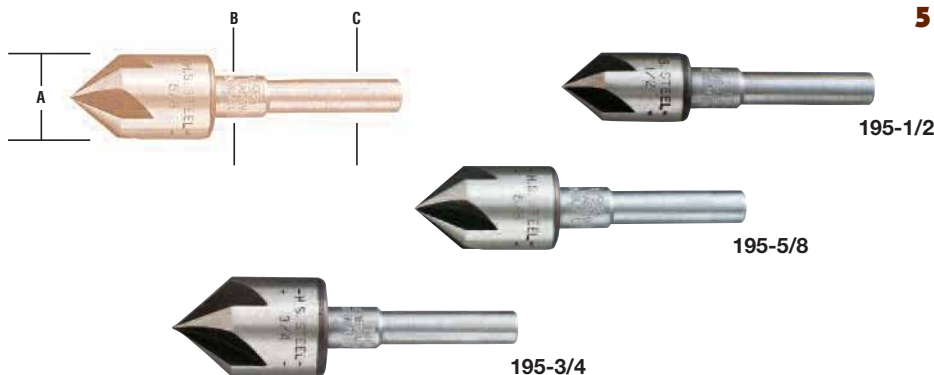

5 FLUTE ROSE PATTERN COUNTERSINKS

- The rose pattern cutting flutes assure chatter free countersinking on steel, brass, aluminum, plastic, wood & other materials
- Made of high-speed steel with five flutes
- 82° point angle
- Stepped shank for use with 1/4" and 3/8" chucks

UPC	NO.	A	B	C
23047 8	195-1/2	1/2"	3/8"	1/4"
23053 9	195-5/8	5/8"	3/8"	1/4"
23050 8	195-3/4	3/4"	3/8"	1/4"



ADJUSTABLE PILOT BITS

- Drill, countersink and counterbore precision screw holes in a single operation when doing fine carpentry and woodworking
- Hardened high-speed pilot bits give long life
- Black oxide finish deters rust

- 1/4" hex shanks prevents slippage in electric drills and can be used in power screwdrivers
- Adjustable drill and high performance angle on countersink

UPC	NO.	SCREW SIZES
23041 6	34ST	Set of 4 Pilot Bits (Sizes 5 - 14)



SELF-CENTERING HINGE BITS

- Highly accurate bits are used for drilling pilot holes in cabinet and door hinges, door butts and all large and small hardware

- Spring loaded outer guide keeps the high speed drill centered for perfect pilot holes
- Adjustable drill depth

UPC	NO.	Drill Size	drill depth	Screw Size
22154 4	291	5/64"	1/8"	3 & 4 screw size
22149 0	292	7/64"	7/32"	5 & 6 screw size
22150 6	293	9/64"	5/16"	8 & 10 screw size



PLUG CUTTERS

- General's Plug Cutters produce accurate plugs for covering screw holes in decking, flooring and other woodworking projects
- Permits choice of matching or contrasting plugs for decorative effect
- Engineered to start cutting plugs easily with hand-held drills or drill press
- Cutter will produce and eject straight plugs from stock up to 3/4" thickness
- Made of hardened alloy steel

- Individual sizes:

UPC	NO.	Shank	Dia.
23024 9	31A	3/8"	3/8" dia.
23030 0	31B	3/8"	1/2" dia.
23033 1	31C	3/8"	5/8" dia.

- Set of 3 Diameters - 1/4", 3/8", 1/2":

UPC	NO.	Shank
23036 2	S31	3/8"



JIFFY CENTERING PUNCH

- For quickly starting screw holes when attaching countersunk hardware such as hinges, hasps, hangers and drawer pulls
- Countersunk end ensures starting hole is centered in hardware screw hole

- Hardened steel pin

UPC	NO.	LENGTH	BODY DIA.
24018 7	806	2-1/2" (68mm)	3/8" (10mm)



Gages/Layout Tools



General has a full range of Gages designed for the specialized measurement operations necessary in construction jobs, cabinet making and fine

carpentry. Woodworkers trust the quality, accuracy and value that General Tools gives them. It's your job . . . General Tools make it easier.

HOBBY DRILL GAGE

- Heavy gage stainless steel gage conveniently identifies drill bit sizes
- Etched graduations are filled in black to give high contrast and will not wear off
- Gage measures 2-3/8" x 6-3/4" (60 x 172mm) overall
- Stainless steel will not rust

UPC	NO.	SPECIFICATIONS
22011 0	24	Fractional size drills 1/16" to 1/2" x 64ths



24

STAIR GAGE SET

- Brass plated steel stair gage assures fast and uniform layout in repetitive work including angle cuts on rafters and stair stringers
- Attaches easily to all metal rafter squares
- Set of 2 pieces

UPC	NO.
24009 5	803

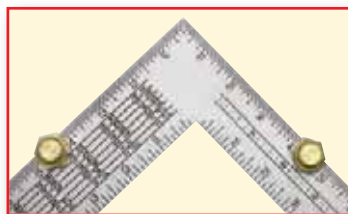

803

Pro-ANGLE™ DIGITAL PROTRACTOR

Take the guesswork out of measuring, marking, reading and transferring angles.

- 6" (150mm) Stainless Steel Protractor Arm with Knurled Locking Nut
- Large, easy-to-read display
- Absolute and Relative measurements
- Accuracy: 0.1°
- Resolution: 0.05°
- Range: 0.00° to 180.00°
- Display can be inverted for easy reading
- Hold function to freeze measurement
- Includes: 1 "CR2023" (3.0V) battery

UPC	NO.
26008 6	1702



1702



Inverted Display



ULTRA TECH™ TOOL SYSTEM

Layout Tools

General's Contour Gages can duplicate any shape. The stainless steel pins on our gage slide to conform to irregular surfaces. This tool can be used for pattern and mold making, duplicating parts and contours.

Great for fitting carpet, floor tiles and linoleum against door casings and pipes. The **ANGLE-IZER™** can replace the need for making templates and can be used again and again. **The Ultimate Template Tool.**

WOODWORKING



833



10" CONTOUR GAGE

- Extra length is ideal for woodworking, linoleum installation, ceramic tile installation or any job where contour duplication is essential
- Gage will fit profiles up to 10" long
- Inch/mm graduations on body
- 3" (76mm) deep fingers will measure profiles up to 1-1/4" (32mm)
- Made from tough, durable plastic

UPC	NO.
08330 2	833



837

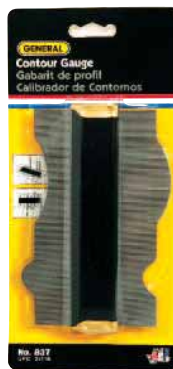

6" CONTOUR GAGE

- Ideal for woodworking, linoleum installation, or any job or hobby where contour duplication is essential
- Inch graduation on body
- Stainless steel pins
- Component parts are enamel painted and brass plated
- Size is 6" x 3-1/2" (152 x 89mm) with an overall travel of 5-1/4" (133mm)

UPC	NO.
24116 0	837



836

THE ANGLE-IZER™

- The unique and versatile **ANGLE-IZER™** The Ultimate Template Tool eliminates the need for making templates and can be used again and again
- The **ANGLE-IZER™** can be set-up in seconds not only improving quality but saving time
- Just form the tool into the shape of your work area, then use it to mark your work-piece to be cut
- Repeat accurate marking for creating bulls eyes, arches, repetitive angles or shapes

- Tool can be set to mark bricks, tiles, lumber and laminates
- All the arms are dual-calibrated in inches and metric measures
- Unique tightening mechanism for one-handed operations
- Fiberglass filled nylon for added strength and flexibility
- Includes FREE instructional **ANGLE-IZER™** CD program

UPC	NO.
08360 9	836



REPETITIVE MARKING



MARKING LUMBER



ANGLES FOR PAVER BRICKS

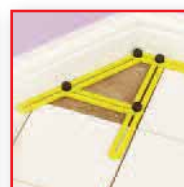

TILING



SPACING AND GAUGING

Patent No. Des. 402,217



General's Compasses and Layout Tools are designed for the specialized operations of measuring and layout necessary in construction

jobs, cabinet-making and fine carpentry. Woodworkers trust the quality and the value that General Tools provides.

OUTSIDE, INSIDE & SLOPED ANGLE PROTRACTOR

- Use this protractor/angle finder to measure and mark the degrees of an angle on outside, inside and sloped angles
- Fine black graduations from 0° to 165° in opposite directions
- Brass lock nut

UPC 22148 3 NO. 29

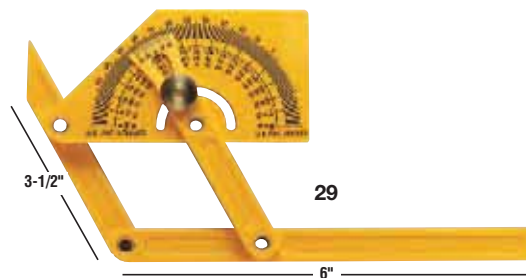

PROFESSIONAL QUALITY T-BEVEL

- Our T-bevel is the tool preferred by the craftsman who wants the finest
- Solid mahogany 5-1/2" (140mm) handle with brass trim and locking wing nut
- 10" (254mm) blade
- Conforms to government specifications GGG-B-211b

UPC 24100 9 NO. 829



FIBERGLASS FOLDING RULE

- Constructed of tough, flexible high impact plastic, with fiberglass reinforcement for added durability
- 72" (1929mm) folding ruler with a 6" (152mm) extension for accurate inside measurements

UPC	NO.	GRADS
25300 2	7200	Outside readings 16ths graduated in 16ths.



PENCIL COMPASS AND SCRIBER

- Designed for marking contours and circles
- Positive wing nut adjustment
- Full-length hardened steel pin in metal frame for greater rigidity
- Constructed of brass plated steel

UPC	NO.	CAPACITY
24132 0	843/1	8" (203mm)

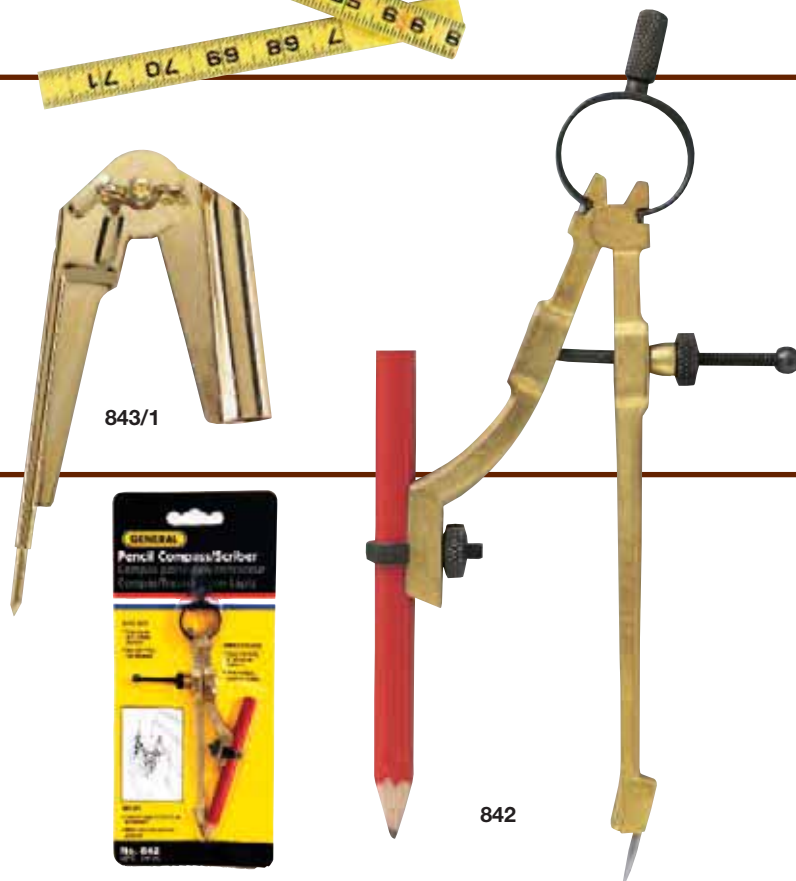

PRECISION PENCIL COMPASS

- Carpenter quality compass is made of long lasting die-cast, rust resistant metal
- Spring tension adjustment for marking up to 9" (229mm) diameters
- Scribe guide for edge marking
- For use with pencil (included) or slim ballpoint pen

UPC	NO.	CAPACITY
24126 9	842	9" (229mm)



WOODWORKING



Calipers & Squares

General's newest "Fraction +" Caliper has a 3 mode digital display. Measuring in inches, metric and fractions it offers everything for the hobbyist to the professional.

The Combination Squares are specifically designed for carpenters, the woodworking trade, the do-it-yourselfer and home mechanics. A necessary tool for every carpenter and home workshop.

WOODWORKING



FRACTION+

DIGITAL FRACTIONAL CALIPERS

- No. 147, No. 1478, No. 14712 are heavy-duty stainless steel construction
- No. 146, No. 1433 has a lightweight non-marring plastic housing
- Convenient auto-off feature
- Three mode digital display: Decimal Inches, Fractional and Metric
- Inside, outside, depth & step measurements
- Accuracy: +/- 0.001" +/- 0.02mm
- Resolution: 0.0005", 0.01mm, 1/64"
- Power Source: 1 "SR44" battery (included)

147



No. 146 Digital Display



No. 147 Fractional Display

UPC	NO.	RANGE
01460 3	146	0 - 6" (0 - 153mm)
01470 2	147	0 - 6" (0 - 153mm)
01433 7	1433	0 - 3" (0 - 76mm)
01478 3	1478	0 - 8" (0 - 203mm)
14712 7	14712	0 - 12" (0 - 305mm)

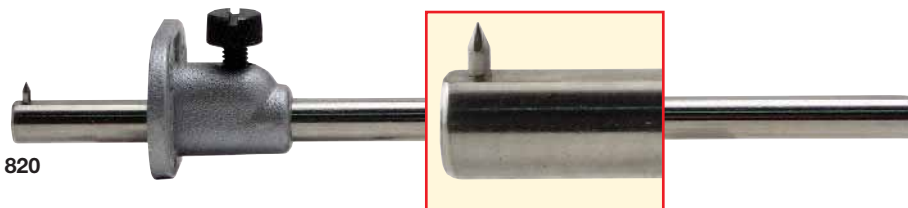

820

SINGLE BAR MARKING GAGE

- 6" (153mm) adjustable bar is nickel plated steel graduated in 16ths
- Die-cast head
- Fine needle point for precision marking

UPC	NO.
24050 7	820

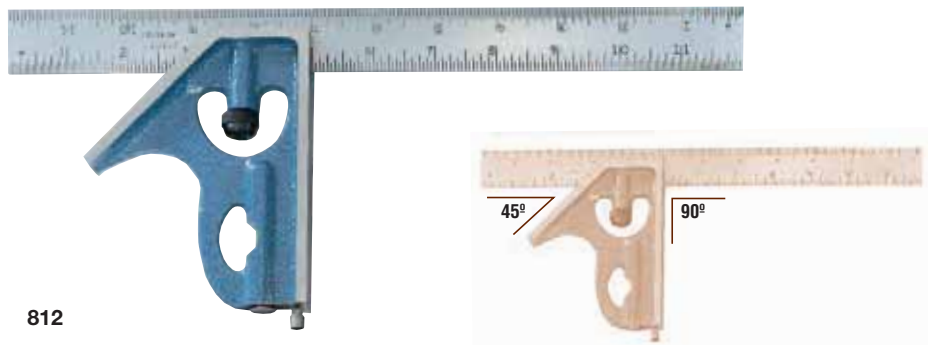

812

PROFESSIONAL CARPENTER'S COMBINATION SQUARE

- Specially designed for carpenters and the woodworking trades
- Machined and enameled cast iron head has precision level and scriber for producing right and 45° angles
- 12" x 1" (305 x 26mm) steel blade is graduated in 8ths, 16ths, and 32nds
- Conforms to government specifications GGG-S-656C

UPC	NO.	GRADS	
		FRONT	BACK
24036 1	812	8ths, 16ths	16ths, 32nds
22193 3	812-CA	Clamp Assembly	

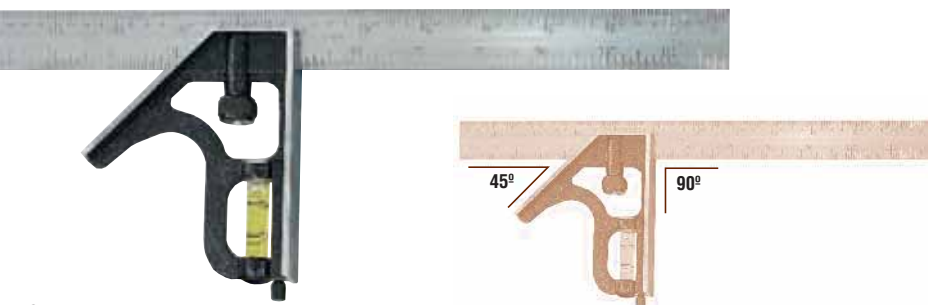

811

UTILITY COMBINATION SQUARE

- Economy version of the carpenter's combination square is perfect for the do-it-yourselfer and home mechanic
- 12" x 1" (305 x 26mm) steel blade is graduated in 8ths, 16ths, and 32nds
- Heavy zinc cast head with level and scriber

UPC	NO.	GRADS	
		FRONT	BACK
24030 9	811	8ths, 16ths	16ths, 32nds



General's Adjustable Trammels accurately measure and mark distances that are too great for conventional compasses and dividers. Trammels will accurately transfer measurements, scribe arcs

and lay out circles. Points can be replaced with pencils, ballpoint pens, crayons or soap-stone sticks for marking various materials.



PRECISION ADJUSTABLE TRAMMELS

- Draw large circles and measure sizable distances with the accuracy of a divider
- Fine adjusting screw sets points accurately
- Points are removable and may be replaced with the pencil holder
- Die-cast bodies with hardened and ground 3" (76mm) needlepoint legs
- Clamp opening for beam is 3/8" x 3/4" (10 x 19mm)
- Conform to government specifications GGG-T-661b

UPC	NO.
23090 4	520
31104 7	84P Replacement points (12 per pkg.)

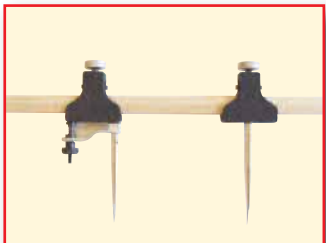

520

PROFILE VIEW

ADJUSTABLE TRAMMELS

- General's adjustable trammels accurately measure and mark distances that are too great for conventional compasses and dividers
- For layouts, marking templates, and drawing large circles
- 6" (153mm) eccentric points provide fine adjustments
- Points can be replaced with pencils, ballpoint pens, crayons, or soapstone sticks for marking various materials
- Clamps onto beam 5/8" to 1-1/2" (16 to 38mm) thick of any length

UPC	NO.
23093 5	523

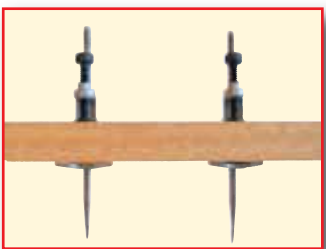

523

PROFILE VIEW

PRECISION TRAMMEL SET

- Will accurately transfer measurements, scribe arcs, and lay out circles too large for conventional compasses
- Will fit any scale, 1/2" to 1-1/8" (13 to 29mm) wide
- Two scriber points and two pencil points included
- Up to four points can be stored in body
- Free-wheeling thimble for greater precision
- Aluminum knurled body
- Steel collet holds replacement leads, scribes and crayons
- Points reverse into body for safety
- Ruler not included in set

UPC	NO.
23095 9	524



524

PROFILE VIEW

WOODWORKING



Scratch Awl & Blade Sharpener

General's Scratch Awl is made from the finest materials for long life. This tool is designed for scribing and layout work, starting screw holes and piercing soft materials.

The Chisel/Plane Blade Sharpener keeps blades razor sharp. The graduated settings maintain the correct 30° cutting angle necessary for these blades.



Shown Actual Size



818



HARDWOOD HANDLE SCRATCH AWL

- Alloy steel blade runs through the handle and is securely fastened to both the plated steel ferrule and the cap
- Hardwood fluted handle is contoured for comfortable grip
- Our finest best selling scratch awl

UPC	NO.	A	B
24047 7	818	6-1/2" (165mm)	3-3/4" (95mm)



809

CHISEL/PLANE BLADE SHARPENER

- Keeps chisel and plane blades razor sharp
- Graduated settings maintain correct 30° cutting angle on chisel or plane blade
- Spring clamp locks in blades up to 2-5/8" (67mm) wide
- Made of high impact fiberglass reinforced Lexan®
- Folds for storage

UPC	NO.
24024 8	809

WOODWORKING

FEATURES

SPECIFICATIONS

MOISTURE METER

Ideal to use in woodworking, building construction and agriculture. Meter is also used in the restoration business to check if there is moisture in carpets and sub-flooring.

- LED Display
- Check wood, drywall and concrete before painting, sealing or treating
- Locate and identify water leaks in roofs, floors and walls
- Ideal for selecting dry lumber
- Great for home owners, contractors and inspectors
- CE, RoHS approved

- ◆ Display: Progressive LED's, 3 Green (5, 10, 12%); 2 yellow (14, 16%); 3 Red (18, 20, 22%)
- ◆ Range: 8-22%
- ◆ Resolution: 0.1%
- ◆ Accuracy: ±2%
- ◆ Sampling Rate: 1s
- ◆ Operating Environment: 32° to 122°F (0 to 50°C), RH<90%
- ◆ Size: 5.7" x 2.4" x 1.2" (145 x 60 x 30mm)
- ◆ Weight: 4.4 oz. (125g)
- ◆ Power Source: 1 "9V" battery (included)
- Includes: • Protective Cover
• Instruction Manual

UPC	NO.
10188 9	MM1E



CE
RoHS

MM1E

DIGITAL MOISTURE METER

Ideal for contractors and homeowners to accurately measure moisture content in wood, concrete, drywall, subflooring and other construction materials.

- Accurately and professionally measure moisture in wood and building materials including brick, concrete, drywall, plaster, wood and lumber
- Strong stainless steel pins
- Audible alarms
- Battery status indication
- Hold button to freeze/hold reading
- Ergonomically designed
- CE approved

- ◆ Measuring range:
Wood: from 5% – 50%
Building material: from 1.5% – 33%
- ◆ Resolution: 0.1%
- ◆ Accuracy: ±3%
- ◆ Audible alarm: 8 different tones level
- ◆ Auto power off: 3 minutes
- ◆ Power Source: 1 "9V" battery (included)
- Includes: • Protective Cover
• User's Manual

UPC	NO.
41447 7	MMD4E



CE

MMD4E

NON-INVASIVE MOISTURE METER

Ideal for use in wood / timber industry and building material storage.

- Moisture display on LCD.
- Data hold to freeze reading and display
- Auto calibration
- Low battery indication
- Sense 6 different materials including 50 types of wood/timber
- Audible sound at 'peak' detection
- Auto power off
- CE, RoHS approved

- ◆ Measuring moisture from 0.0% to 99.9% with 10 different groups
- ◆ Resolution: ±1 digit
- ◆ Sense depth maximum: 3/4" (20mm)
- ◆ Power Source: 1 "9V" battery (included)
- Includes: • User's Manual

UPC	NO.
40142 2	MMD5NP



CE
RoHS

MMD5NP

PRECISION DIGITAL AND LED MOISTURE METER

Measures moisture content in wood, timber and other commercial / industrial material.

- Wood material: 6% to 40% moisture content
- Concrete material: 0% to 100% moisture content
- Also measures temperature
- Red LED bar graph indicator with LCD display
- Easy Operation
- Replaceable Tips
- Hold, Record (Min/Max)

- ◆ Pin length: .5"
- ◆ Power Source: 1 "9V" battery (not included)
- Includes: • Extra pins
• Protective Cover
• User's Manual

UPC	NO.
07003 1	MMD7003
01255 0	MP7003 External Pin Type Probe (Optional)

MMD7003



WOODWORKING



MMD6NP

FEATURES

NON-INVASIVE MOISTURE METER

Precision instrument for highly sensitive and non-invasive measurement of moisture content in wood, timber and other industrial applications.

- High accuracy
- Fast measuring time
- Wide measuring range and high resolution
- High resolution digital display
- Zero value and correction value can be stored
- Strong, light weight ABS-plastic housing
- Comfortable fit for either hand

SPECIFICATIONS

- ◆ Display: 3 digits, 10mm LCD
- ◆ Range: 0 to 80% ◆ Resolution: 0.1%
- ◆ Accuracy: $\pm(1\%n+1)$ under 30%, $\pm(2\%n+1)$ over 30%
- ◆ Sampling time: 1.0s
- ◆ Operating condition: Temp. 0° to 50°C, Humidity: <80%
- ◆ Dimensions: 218 x 76 x 53mm
- ◆ Weight: 260g (with batteries)
- ◆ Power Source: 4 "AAA" batteries (included)

UPC	NO.
40143 9	MMD6NP



CE
RoHS

MM70

PRECISION LED MOISTURE METER WITH SIGNAL OUTPUT

Precision instrument for accurate moisture reading in wood and timber.

- 1% Accuracy
- High Resolution Multi-color LED bar graph readout 5.5% to 99.9% moisture range
- Protective cap for safe carrying and operation
- Auto temperature compensation and calibration adjustment
- 99 Point memory
- Ergonomic design, comfortable and durable
- Convertible to non-invasive measuring by adding optional MP7002 probe

- ◆ Measuring Range: 5.5 to 99.9% H₂O %WME
- ◆ Accuracy (at 25°C): $\pm 1\%$ Wood Scale
- ◆ Indicator: LED bargraph
- ◆ Color Codes: Green (<16%) Yellow / Red (>21%)
- ◆ Signal Output: 0 to 1Vdc 10mV%
- ◆ Calibration: Automatic Temperature compensation
- ◆ Built-in calibration adjustment
- ◆ Power Source: 1 "9V" battery (included)

UPC	NO.
07020 8	MM70
70604 6	MP7021 External Pin Type Probe 39" (1 meter) long (Replacement)
07070 3	MP7022 External Roller-Type Probe 39" (1 meter) long (Optional)

- Audible Alarm starts for catch reading
- Audible and visual low battery warning
- Additional set of long pins .9" (23mm) included
- CE and RoHS approved
- 1 MM70 Meter with .5" (12.7mm) pins
- 1 MP7021 External Pin Type Probe 39" (1 meter) long with .5" (12.7mm) pins
- Additional Set of Interchangeable Long Pins .9" (23mm)
- Protective Fabric Carrying Case
- User's Manual



MM70D

PRECISION DIGITAL MOISTURE METER WITH SIGNAL OUTPUT

Precision digital instrument for accurate moisture reading in wood and timber.

- 1% Accuracy
- Digital LCD display with luminescent back-light
- Protective cap for safe carrying and operation
- Hardened gloss treatment on display-window for an abrasion-proof long-term clean lens
- 5.5% to 99.9% moisture range with DC 0~1V output
- Stores up to 99 readings, Max/Min average values recalled
- Auto temperature compensation and internal calibration
- Auto power off
- Ergonomic design, comfortable and durable
- Easy operation
- Audible and visual low battery warning
- Usable and changeable extension probe
- Additional set of long pins .9 in. (23mm) included
- CE and RoHS approved

- ◆ Measuring Range: 5.5 ~ 99.9% H₂O %WME
- ◆ Resolution: 0.1%
- ◆ Accuracy: (at 25°C) $\pm 1\%$ Wood scale
- ◆ Display: Digital dual LCD display, with multi-function indicator
- ◆ Sampling Rate: 0.3 seconds
- ◆ Wood group scales: Select from 8 wood species groups
- ◆ Data memory: 99 readings
- ◆ Signal output: Analog DC 0 ~ 1V (10 mV / 1%), load > 500Ω
- ◆ Calibration: Built-in calibration adjustment
- ◆ Power: About 250 hours for continuing use (none back light)
- ◆ Operating: -20° to +55°C, <90%RH, non-condensing
- ◆ Dimensions: 6.0 x 2.2 x 1.26 in. (153 x 56 x 32mm)
- ◆ Weight: 5.5 oz. (155g) including battery
- ◆ Power Source: 1 "9V" battery (included)

- Includes:
- 1 MM70D Meter with two .5 in. (12.7mm) pins
 - 1 MP7021 External Pin Type Probe 39 in. (1m) long with .5 in. (12.7mm) pins
 - Additional Set of Interchangeable Long Pins .9 in. (23mm)
 - Protective Fabric Carrying Case
 - User's Manual

UPC	NO.
07010 9	MM70D
70604 6	MP7021 External Pin Type Probe 39 in. (1 meter) long (Replacement)
07070 3	MP7022 External Roller-Type Probe 39 in. (1 meter) long (Optional)