

CONTENT

| | | | |
|--|----|---|----|
| <i>Product Features</i> ----- | 2 | <i>Video Recording</i> ----- | 11 |
| <i>Before Use</i> ----- | 4 | <i>Viewing photos/videos</i> ----- | 12 |
| <i>System Modes</i> ----- | 5 | <i>Setting Time/Date</i> ----- | 12 |
| <i>Multi-function keys</i> ----- | 6 | <i>Setting Time Display</i> ----- | 13 |
| <i>Manual On Screen</i> ----- | 7 | <i>Viewing on a TV monitor</i> ----- | 13 |
| <i>DELETE ALL</i> ----- | 7 | <i>Setting video format</i> ----- | 14 |
| <i>VIDEO OUTPUT</i> ----- | 7 | <i>Deleting a specific photo (Browse mode only)</i> - | 14 |
| <i>DATE/TIME SETUP</i> ----- | 8 | <i>Deleting all photos</i> ----- | 15 |
| <i>LANGUAGE</i> ----- | 8 | <i>Setting auto power off</i> ----- | 15 |
| <i>VIDEO FORMAT</i> ----- | 8 | <i>Re-charging the battery</i> ----- | 16 |
| <i>AUTO POWER OFF</i> ----- | 8 | <i>Creation of Memory Card Folder</i> ----- | 17 |
| <i>Channel Adjusting</i> ----- | 9 | <i>Specifications</i> ----- | 18 |
| <i>Operating Instructions</i> ----- | 10 | <i>Troubleshooting</i> ----- | 20 |
| <i>Power On/Off</i> ----- | 10 | <i>Insertion Tube Maintenance</i> ----- | 20 |
| <i>Change from Wireless to Direct Mode</i> ----- | 10 | <i>Cautions for Use</i> ----- | 21 |
| <i>Control Handle Indicator Lights</i> ----- | 11 | | |
| <i>Taking Photos</i> ----- | 11 | | |

Product Features

Handle/Controller

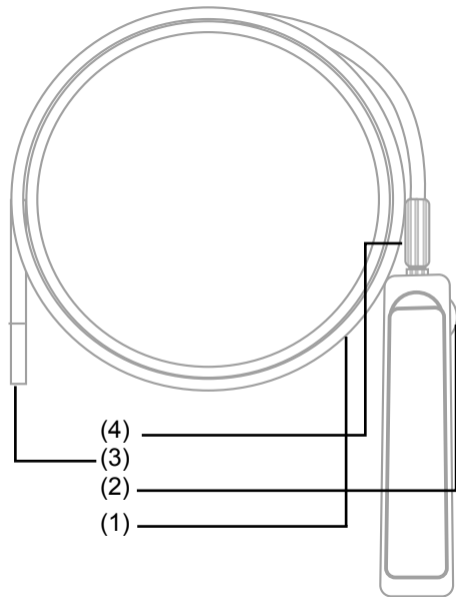

1 – Handle

- (1) Insert Tube
- (2) On/Off Switch & Light
Source Adjustment
- (3) Camera Lens
- (4) Insert Tube Connector

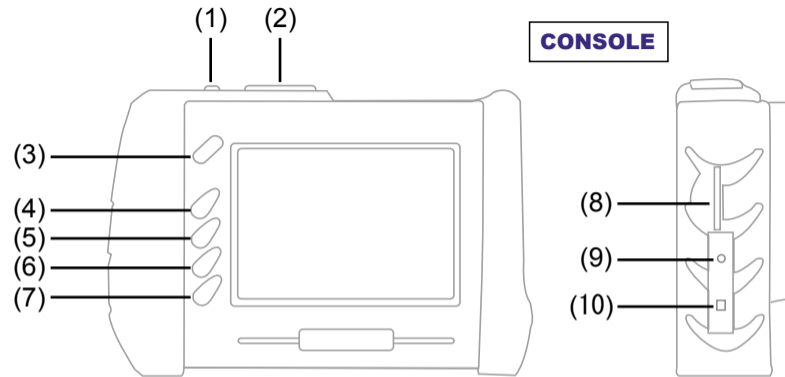

2 – Console

- (1)  RECORD
- (2)  SNAP
- (3)  POWER
- (4)  PREVIOUS
- (5)  NEXT
- (6) **OK/MENU**
- (7) **ESC**
- (8) SD Port
- (9) Video Output
- (10) AC Jack

(Please read the entire instruction manual before usage)

Before Use

STEP 1 - Insert the insertion tube into the connector according to the direction of the arrow and tighten the screw nut.

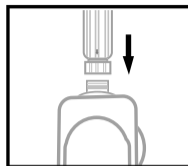

(Figure.1)

STEP 2 - To activate the insertion tube controller, turn the LED adjustment dial clockwise until you hear a “click” followed by illumination of the adjacent green light.

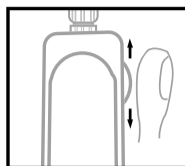

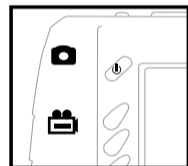

(Figure.2)

STEP 3 - Press and hold down the  power button on the console for 3 seconds until the image is displayed on the monitor.



(Figure.3)

STEP 4 - Aim the camera lens at the selected object. Press  SNAP to capture a .jpg image, or  RECORD to begin recording a .asf video.

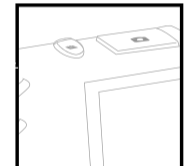

(Figure.4)

Direct or Wireless transmitting modes

Your **DCS1800** provides two transmitting modes, “Direct Mode” and “Wireless Mode”.

»Direct Mode – Simply insert the insertion tube controller into the USB socket located on the back of the console. This will automatically activate the Direct Mode transmitting mode. During Direct Mode, all images are transmitted through the wired socket, not wirelessly. This can be helpful when working in an area where other high frequency wireless equipment is being used because there will be no interference with the video signal.

»Wireless Mode – **DCS1800** also has a built-in wireless transmission function. It will adjust to Wireless Mode automatically once the console and insertion tube controller are separated.

System Modes



The **DCS1800** provides three simple working modes: Preview, Browse and Manual Mode.

| | |
|--------------|--|
| Preview Mode | The Preview Mode is activated as soon as the unit is turned on. The image received by the camera is displayed in real time on the video monitor. The user can capture photos and video recordings while in the Preview Mode. |
| Browse Mode | In Browse Mode, users may view photos and video, and conduct basic file maintenance . |
| Manual Mode | In Manual Mode, users may customize their set up preferences. |

Note: The system returns to Preview Mode automatically after 10 seconds without any response in Manual Model.

Multi-function keys

Each console button performs a unique function depending upon the Mode in which the system is being operated.

| Push-Buttons | Preview mode | Browse Mode | Manual Mode |
|---|--|--|------------------------------------|
| ▲ | Switch to Browse Mode to view photos and videos. | Move to previous photo or video. | Move upward through the main menu. |
| ▼ | Switch to Browse Mode to view photos and videos. | Move to next photo or video. | Move the light bar downward. |
| OK/MENU | Enter Manual Mode. | Delete photo or video. | Execute selected command. |
| ESC | Return to Preview Mode. | Return to Preview Mode. | Return to Preview Mode. |
|  | Capture a .jpg photos | View the next photo or pause/play video clips. | Display various data for repair |
|  | Start and stop video recording | Return to Preview Mode | Return to Preview Mode |

Manual On Screen

The user may press the **OK/MENU** button in Manual Mode to execute desired commands as indicated below.

DELETE ALL
VIDEO OUTPUT
DATE/TIME SETUP
LANGUAGE
VIDEO FORMAT
AUTO POWER OFF

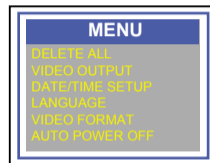

(Figure.5)

DELETE ALL

After initiating this command, select “yes” or “no” by pressing up or down arrow buttons. To delete all, select “yes”. Exit by pressing the **OK/MENU** button.

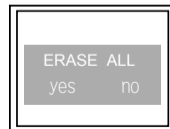



(Figure.6)

VIDEO OUTPUT

This command will send the video signal out through the AV port. The monitor will turn black until you execute this command again.

DATE/TIME SETUP

Use the arrow buttons to select Year/Month/Day or Hour/Min/Sec. Press  RECORDING to increase the number, or press  SNAP to decrease. Select "Display ON" to print the date on the photo.

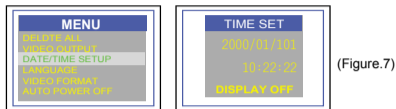

(Figure.7)

LANGUAGE

Use this command to select the desired language.



(Figure.8)

VIDEO FORMAT

Set up your video format.

AUTO POWER OFF

Set the auto power off feature to your desired length of time.

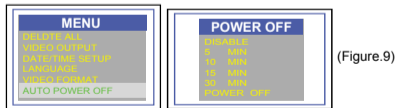

(Figure.9)

Channel Adjusting

The **DCS1800's** handle and console must be on the same channel during wireless transmission. Adjust the channel by using a small slotted screw driver following the direction of the arrow sign as shown below.

Users may refer to the following table to choose a suitable channel.

| Channel | Arrow Indication | Frequency |
|---------|------------------|-----------|
| 1 | 9,1 | 2414MHz |
| 2 | A,2 | 2432MHz |
| 3 | C,4 | 2450MHz |
| 4 | 8,0 | 2468MHz |

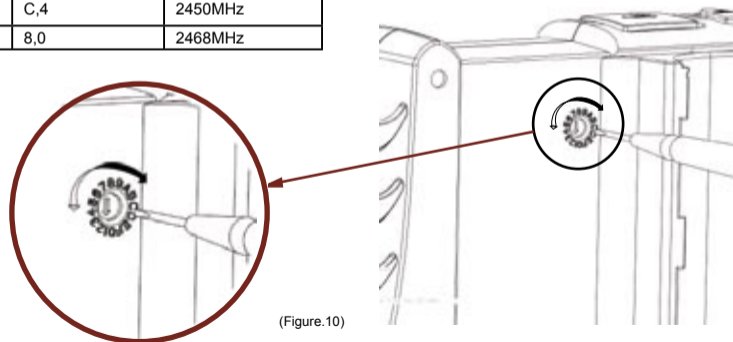



(Figure.10)

Operating Instructions

Power On/Off

STEP1: To turn the console on, press the  power button for 3~5 seconds until you see the sign below appear on your monitor.

( SD card memory capacity  Battery capacity)

STEP2: Press the power button for 3~5 seconds to turn the console off.

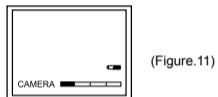

(Figure.11)

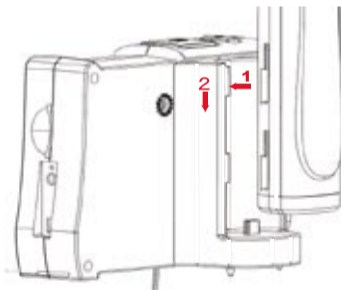

(Figure.12)

Change from Wireless to Direct Mode

STEP1: Slide the handle into the USB socket as demonstrated in the diagram below.

STEP2: The image may appear fuzzy momentarily while switching from wireless to direct mode.

Control Handle Indicator Lights

| Light | Indication | Status Description |
|----------|---------------------------------|--|
| Green | In use | Working under full battery |
| Dark Red | Low battery | Please recharge the battery when the dark red light appears during usage |
| Orange | Charging while in use | Charging while in use |
| Red | Charging while power off | Charging while power off |
| None | Full battery (during power-off) | The light dims when the battery is fully charged |

Taking Photos

Press  button during Preview mode to take the photo.

Or, continue pressing the  button to show the photo that had just been taken.

Image Status: Returns to preview Mode automatically after photo is taken.



(Figure.13)

Video Recording

1. Press  button to start video recording.

Image Status:  sign will appear at the left bottom of the screen.



2. Press  button again to stop recording.

Image Status:  sign disappears.



(Figure.14)

Note: User may return to Preview mode anytime by pressing  button regardless of working under Browse mode or Manual mode.

Viewing photos/videos



1. Press  or  during preview mode.

Image Status: Display the latest photo/video.









2. Press  or  again to view the oldest or second to last photo/video.

Image Status: All files will be stored according to the time sequence of photo capture/video recording.

Note: When viewing videos, the video will be displayed automatically until it ends and then the next photo or video will be displayed.

Setting Time/Date

1. Press **OK/MENU**
2. Press  or  to move to Date/Time command.
3. Press **OK/MENU** to initiate the command.
4. Press  to increase the number or  to decrease.

5. Press  for next adjustment.
6. Repeat step 4 and 5 until the correct time/date are set.
7. Press **OK/MENU** to complete the set up.

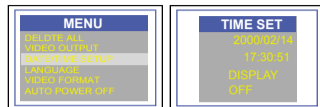

(Figure.16)

Setting Time Display







1. Press **OK/MENU**
2. Press  or  to move to “Date/Time” command.
3. Press **OK/MENU**
4. Press  or  for “Display” option.
5. Press  to switch the “Display” function between ON/OFF.

Image Status: Press  once for ON, press again for OFF.

6. Press **OK/MENU** to complete set up.
7. Press **ESC** to return to Preview mode.

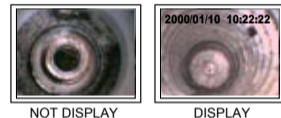

(Figure.17)

Viewing on a TV monitor

1. Plug the included AV cord into the AV socket located on the right side of the console.

Notice: Please plug the other end of the AV cord into the “AV in” socket on the external monitor.

2. Press **OK/MENU**
3. Press **▲** or **▼** to move to "Video output" option.
4. Press **OK/MENU**

Image Status: image will be transmitted to the external monitor.

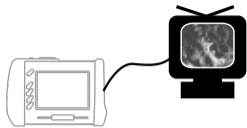

(Figure.18)

Setting video format

1. Press **OK/MENU**
2. Press **▲** or **▼** to move to "Video Format" option.
3. Press **OK/MENU**
4. Press **▲** or **▼** to select NTSC/PAL.
5. Press **OK/MENU**

Deleting a specific photo (Browse mode only)

1. Enter Browse mode, then press **▲** or **▼** to locate the photo or video you wish to delete.
2. Press **OK/MENU**

Image Status: "Delete yes or no" options

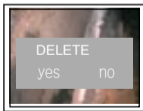

(Figure.19)

3. To select your option, press **▲** or **▼**
Image Status: .The selected option flashes.
4. Press **OK/MENU** to execute your selected option or press **ESC** to cancel.

Deleting all photos

1. Press **OK/MENU** during Preview mode.
Image Status: Showing the Main Menu
2. Press **▲** or **▼** for "Delete All" command.
3. Press **OK/MENU**
Image Status: "yes" or "no" option appears
4. Use **▲** or **▼** to select "yes".
5. Press **OK/MENU** to execute.



(Figure.20)

Setting auto power off

1. Press **OK/MENU** (during Preview mode.)
2. Press **▲** or **▼** for "Auto power off" command.
3. Press **OK/MENU**

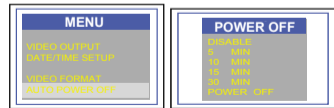

(Figure.21)

4. Press ▲ or ▼ to select desired time length or choose “Disable”.

5. Press **OK/MENU**

The console will automatically turn off if it has not been used for this preset length of time.

Re-charging the battery

•Re-charging the Console battery only

Plug the adapter into the outlet and plug the power jack into the socket on the console.

•Combined Console and Handle re-charging

Insert the handle into the rear slot of the console to re-charge both simultaneously.

•Re-charging the Handle Controller only

Connect the handle controller to a PC or Laptop using a standard Mini USB cable for re-charge.

Caution: 1. Turn off the console and handle during re-charging.

2. Ensure the power of PC/Laptop is turned on during re-charging by USB cable.

3. Ignore the “found new hard drive” message during re-charge by USB cable.

Creation of Memory Card Folder

The following information applies to the included SD card only. All photos and videos are stored in the [100MEDIA] folder under the [DCIM] folder. All files will be named according to the time/date setup.

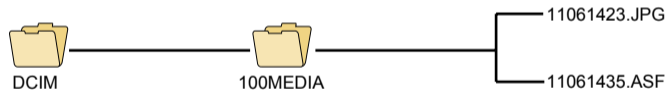
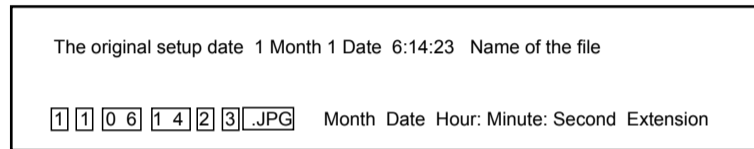

- Users should complete the time/date setup before usage in order to achieve accurate file management.
- The time/date is pre-set to 2007/1/1. Users may identify this when the file name begins with the digits 11.
- File names are not labeled by serial number. They are labeled according to the current time/date.
- Both photos and videos are named in the same way but with different file extensions, .jpg and .asf.

Specifications

| Camera System and Insertion Tube | |
|----------------------------------|--|
| Insertion tubes diameter | 5.5 mm |
| Resolution | 325(H)*250(V) |
| Housing | Steel |
| Light Source | White LED |
| Length | OBEDIENT 3.3', 6.6', 9.8' (1M, 2M, 3M) SOFT METAL 3.3', 6.6', 9.8', 16.4', 32.8', 98.4' (1M, 2M, 3M, 5M, 10M, 30M) |
| Field of View | Horizontal field angle 46° |
| | Vertical field angle 34° |
| | Diagonal field angle 56° |
| Depth of Field (DOF) | 0.4" ~ 2.4" |
| Water Resistant | Only the Insertion tube is water resistant |
| Working Temperature | 32°F to 131°F |
| Console | |
| Dimension | 139.3 * 34.9 * 31.8 mm |
| Weight | 220g |
| Wireless Transceiver Frequency | 2.4GHz 4channels (2414MHz 2432 MHz 2450MHz 468MHz) |
| Battery | Rechargeable Li-Polymer battery 3.7V |
| Brightness Control | Variable |
| Audio | Integrated microphone |

| System | |
|-----------------------------|--|
| System Dimension | 146.9 * 105.4 * 71 mm |
| System Weight | 335g |
| Power | Battery rechargeable Li-Polymer battery 3.7V power supply AC 100-240V 50-60Hz power consumption DC5.5 1.8A |
| Display | 3.5 TFT LCD QVGA |
| Recording Medium | 1G SD CARD (up to 2G) |
| Video Out Format | NTSC & PAL |
| Interface | AV out |
| Wireless Receiver Frequency | 2.4GHz □4channels (2414MHz □2432 MHz□ 2450MHz□ 2468MHz) |
| Compression Format | Compliant with MPEG4 |
| Still Image Storage Format | jpeg (640*480) |
| Frame Rate | ~30 fps |
| Exposure | Automatic |
| White Balance | Fixed |
| S/N Ratio | 42dB or more |
| Language | English // Japanese // German // Spain // French // Italian // Traditional Chinese // Simple Chinese |
| Recharge Temperature | 32°F to 104°F |
| Working Temperature | -4°F to 140°F |
| Storage Temperature | -4°F to 140°F |

Troubleshooting



1. Unable to turn on the console
Users will not be able to turn on the console when the battery is very low or empty. Please recharge before use.
2. Can turn on the unit but the image does not appear on the monitor
Please check the insertion tube connector or simply re-connect the insertion tube to correct the problem.
3. Unable to capture photos/video
Please check the status of the SD card. Users will not be able to capture photos or video if the SD card is not installed properly or if it is full, write protected or damaged.

Insertion Tube Maintenance

1. To avoid danger, please do not put the insertion tube into any flammable liquid or gas.
2. The insertion tube contains a series of small wires that control the optics and electronics of the camera tip. To ensure long-term reliability, do not bend the insertion tube more than 180 degrees, and always bend the insertion tube in as large an arc as possible during usage and storage.

3. Camera Lens cleaning

User may clean the camera lens with a cotton swab and small amount of cleaning naphtha

Cautions for Use



- Do not remove the SD card during capturing photos or video. This can cause a loss of the image or video and may damage the SD card.
- Video recording requires an SD card with fast writing speed. We recommend 80X (or above) writing speed SD cards for better video quality.



- The DCS1800 is designed for industrial purposes only. Do not use the system for human or any other biological inspection.
- Do not insert the insertion tube into any flammable gas or liquid (such as a fuel tank) to avoid dangers.
- Do not use the **DCS1800** in a fuel tank or other dangerous environment such as a gasoline or alcohol storage tank.
- Do not use any corrosive liquid for cleaning, such as alcohol.

- Do not try to disassemble the product. This presents a shock hazard and could damage the unit.
- Do not bend the insertion tube over 180 degrees rigidly during usage or storage.
- Please use only recommended components or accessories. Unapproved accessories and components may cause damage.
- Please do not use the **DCS1800** in a medical facility or on an airplane, as the wireless signal may interfere with other critical equipment nearby.
- Avoid direct exposure to sunlight for long periods of time.
- Store the system in a cool, dry and well-ventilated place.



