



KANOMAXTM

219 Route 206
PO Box 372
Andover, NJ 07821 USA

Phone: 1-800-247-8887
Fax: (973) 786-7586
info@kanomax-usa.com



KANOMAXTM
The Ultimate Measurements

Model 6813TM
THERMO-ANEMOMETER

User Manual



KANOMAXTM

219 Route 206
PO Box 372
Andover, NJ 07821 USA

Phone: 1-800-247-8887
Fax: (973) 786-7586
info@kanomax-usa.com

INTRODUCTION

Congratulations on your purchase of a 6813 Digital Thermo-Anemometer! You now own one of the most accurate, reliable, and highly regarded airflow measurement instruments available today.

Kanomax's model 6813 digital thermo-anemometer is a versatile instrument for measuring air velocity and temperature in various applications such as HVAC, aerospace development, industrial process airflow, and fluids research.

The rugged yet precise probe can be used for airstreams that have a wide range of humidity, temperature and contaminants without compromising accuracy.

Features include custom cable lengths, service temperatures up to 212°F (100°C) at the probe, high reliability, and long life.

**KANOMAX**

TM

219 Route 206
PO Box 372
Andover, NJ 07821 USA

Phone: 1-800-247-8887
Fax: (973) 786-7586
info@kanomax-usa.com

Warranty

This product is fully warranted against defective materials and/or workmanship for a period of one year after purchase, provided it was not improperly used. For your protection, please use this product as soon as possible. If returned, it must be securely wrapped, sent prepaid and insured to:

Kanomax USA Inc.
219 Route 206
PO Box 372
Andover, New Jersey 07821
USA

Please include a note with name, address, telephone number and description of the problem. Although we provide assistance on Kanomax products both personally and through our literature, it is still the total responsibility of the customer to determine the suitability of the product for use in their application.

This manual is provided by Kanomax Instruments without any kind of warranty. Precautions have been taken in accurately preparing this manual; however, we neither assume responsibility for any omissions or errors that may appear nor assume liability for any damages that result from the use of the products in accordance with the information contained in the manual.



SECTION 1 - SPECIFICATIONS

Ranges:

Probe APT275 Airflow: 40 to 7800 ft/min (feet per minute)
0.2 to 40.00 m/sec (meters per second)

Air Probe AP100: 300 to 6800 ft/min (1.5 to 35.00 m/sec)

Temperature: (using either air velocity probe): -4° to 212°F
(-20° to 100°C)

Accuracy:

Air Velocity: **AP275:** ± 1.0% of reading ±1 digit
AP100: ± (0.25% of F.S. + 0.75% of reading + 1 digit)

Temperature: ±(0.3°C + 0.2% of reading in °C)
Temperature accuracy examples: ±0.3°C at 20°C
±0.5°F at 68°F

Resolution:

Air Velocity: 1 ft/min or 0.01 m/sec
Temperature: 0.1°F or 0.1°C

Operating Temperature:

Instrument: 32° to 125°F (0° to 50°C)
Air Probes: -4° to 212°F (-20° to 100°C)

Power Supply: 3 AA alkaline batteries

Battery Life: Approx. 150 hours, without backlight

Battery check: Automatic low battery display

Display: 0.5" LCD, 4 digits, with LED backlight



Options Available:

- Protective Boot and Splash-Proof Seal for the Instrument
- USB Communications
- RS232 Communications
- Analog 0-5 Volt Output
- Additional Probes, APT275 or APT100
- Extra extension and/or flexible rods
- Custom cable lengths

Included:

- (1) 6813 Instrument
- (1) Vane-type probe head with RTD temperature sensor, choice of APT100 or APT275
- (3) Rigid extension rods with handle grip
- (1) Flexible extension rod
- (1) Probe connection cable, 5 ft.
- (3) Size AA 1.5V alkaline batteries
- (1) Hard-shell carrying case with foam liner
- (1) 6813 operation manual

Dimensions

INSTRUMENT

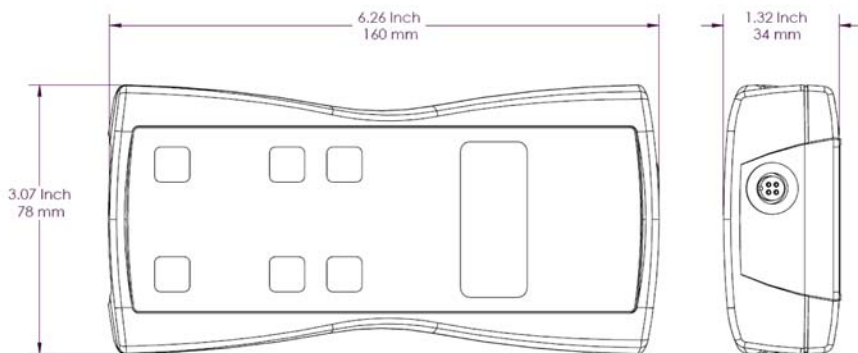



APT275 PROBE

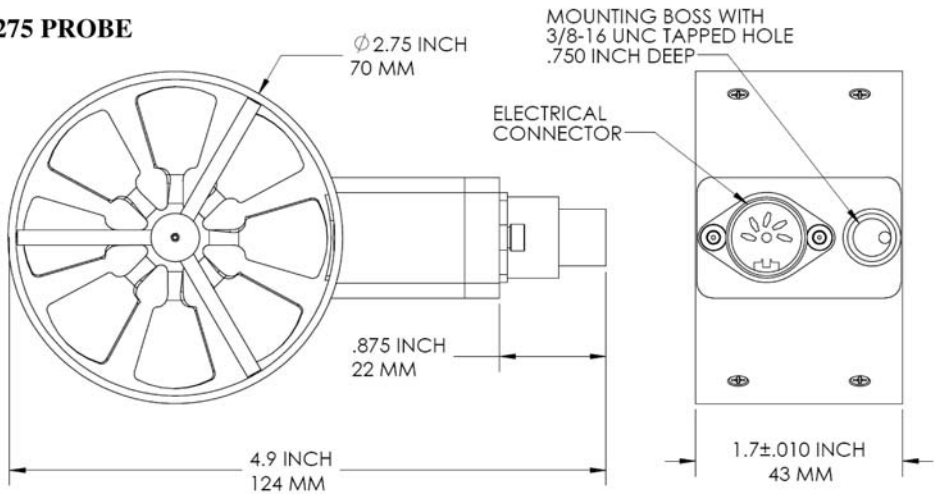

APT100 PROBE

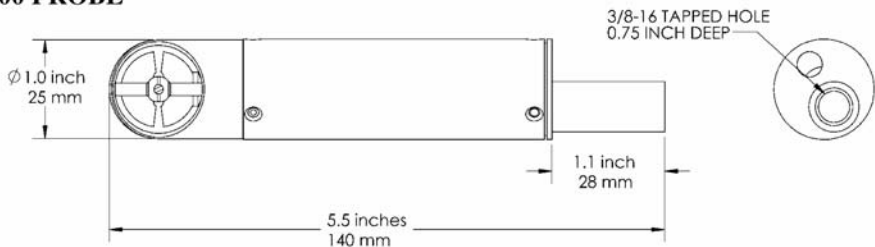



KANOMAX

TM

219 Route 206
PO Box 372
Andover, NJ 07821 USA

Phone: 1-800-247-8887
Fax: (973) 786-7586
info@kanomax-usa.com

SECTION 2 – SWITCH FUNCTIONS

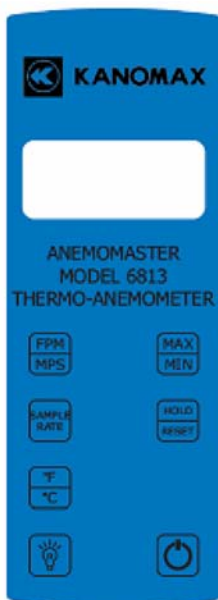

Pressing the ON/OFF key switches the instrument ON. Hold down the key for 2 seconds to switch the unit OFF. The unit will automatically power off after 30 minutes without any key presses. To disable auto power-off, hold down the power button during turn-on. The unit will flash AOFF, which means that the auto power-off has been disabled. The auto power-off is re-enabled each time the instrument is turned on.



Press the BACKLIGHT key to turn the LCD backlight on for 30 seconds. To turn the backlight on permanently, hold the backlight key down for 3 seconds. The LCD will flash. The backlight is now switched on permanently. To switch the backlight off, press the backlight key again.



Press the **TEMPERATURE** key to display the current temperature of the air stream as measured by the Air Probe. To switch the units between degrees Fahrenheit (°F) and degrees Celsius (°C), press the **TEMPERATURE** key again. Either **°C** or **°F** will be displayed along with the reading.



Press the **FPM/MPS** key to display the current air velocity as measured by the air probe. To switch the measurement units from FPM (feet per minute, 1 FPM resolution) to MPS (meters per second, 0.01 MPS resolution), press the **FPM/MPS** key again. Either **FPM** or **MPS** will be displayed along with the reading.



Press the **SAMPLE RATE** key to change the measurement averaging rate (“sample rate”) of the instrument **for air velocity only**.

2SEC An average value of airspeed measurements during the preceding 2 seconds is displayed.

4SEC An average value of airspeed measurements during the preceding 4 seconds is displayed.

8SEC An average value of airspeed measurements during the preceding 8 seconds is displayed.

16 S An average value of airspeed measurements during the preceding 16 seconds is displayed.

Note: The sample rate for **temperature** readings is **always 2 seconds**.



Press the MAX/MIN key to record and display the maximum reading for either temperature or air velocity. The maximum reading display will alternate with the letter "H" displayed with the sample rate. Press the MAX/MIN key again to record and hold the minimum reading. The minimum reading display will alternate with the letter "L" displayed with the sample rate.

For example:

1065 alternating with *H 8* signifies that 1065 is the highest airspeed reading since the MAX/MIN key was pressed, and the sample rate is set to 8 seconds.

82 alternating with *L 16* signifies that 82 is the lowest airspeed reading since the MAX/MIN key was pressed, and the sample rate is set to 16 seconds.

To exit MAX/MIN mode, press the SAMPLE RATE key.



Press the HOLD/RESET key to freeze the current reading on the display. **HOLD** is displayed on the LCD and the reading is held.

Press the HOLD/RESET key a second time to clear this mode and return the unit to normal operation.

Press the HOLD/RESET key while in MIN/MAX mode to display BOTH the minimum and maximum readings since the MAX/MIN key was pressed. Once the HOLD/RESET key is pressed while in MAX/MIN mode, new readings are no longer recorded. To return to MAX/MIN mode, press the HOLD/RESET key again.



KANOMAX

TM

219 Route 206
PO Box 372
Andover, NJ 07821 USA

Phone: 1-800-247-8887
Fax: (973) 786-7586
info@kanomax-usa.com

APPENDIX A – LCD DISPLAY SYMBOLS

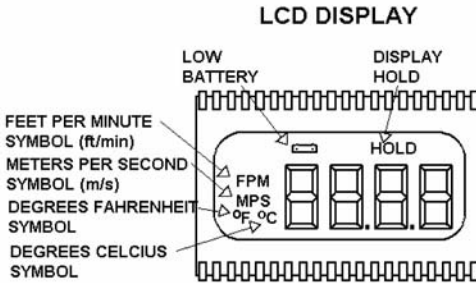

APPENDIX B – BATTERY REPLACEMENT

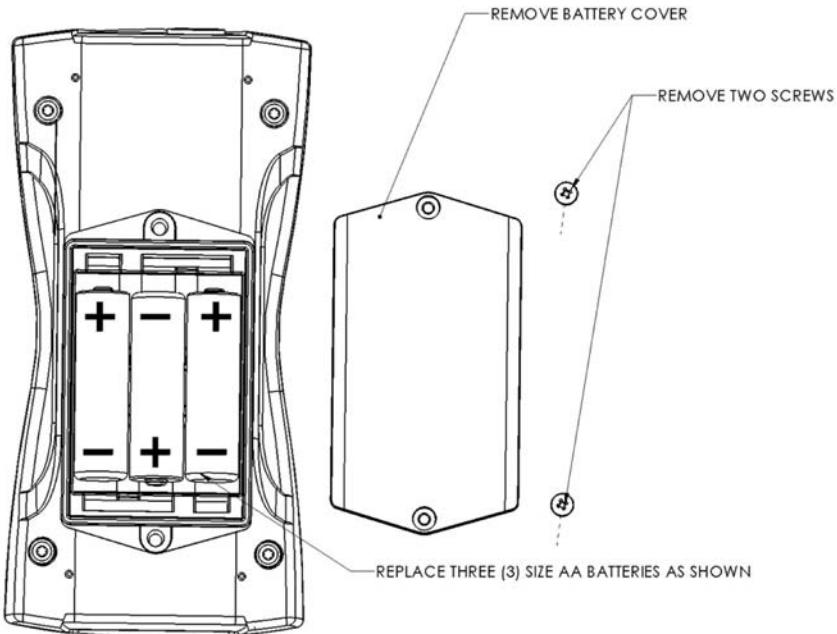



APPENDIX C – AIRFLOW VOLUME CALCULATIONS

To calculate cubic feet per minute (CFM) from a measured air velocity (FPM), you need the calculated cross-sectional area of the air flow stream:

$$\text{Volume Flow (CFM)} = \text{Velocity (FPM)} \times \text{Area (sq ft.)}$$

In a rectangular duct this cross sectional area equals the Width times the Height.

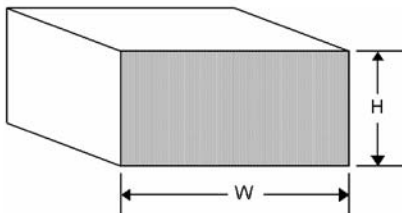

$$W \times H = A \text{ (cross-sectional area)}$$

In a circular duct this cross section area equals the radius squared times π (3.14).

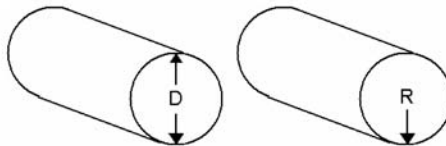

$$R \times R \times 3.14 = A \text{ (cross-sectional area)}$$

To convert an area calculated in square inches to an area calculated in square feet (which is required for the Volume Flow equation above) divide by 144: (area in sq in.)/144 = (area in sq ft.).

Example: The air duct is rectangular, the width is 24 in. and the height is 12 in. The air velocity reading through the duct is 450 FPM. Calculate the Volume Flow.

Step 1: Cross-sectional area = 24 in. x 12 in. = 288 sq in.

Step 2: 288 sq in /144 = 2 sq ft.

Step 3: Volume flow = Air Velocity x Area, therefore,
Volume flow rate = 450 FPM x 2 sq ft. = 900 CFM.

APPENDIX D – ANALOG OUTPUTS (IF EQUIPPED)

If the instrument is equipped with the analog output option, there will be a five-pin connector on the bottom of the instrument. Also, an analog output cable will be included with the instrument. This cable will have a five-pin connector on one end and four tinned wires on the other end.

The instrument will output a Voltage between 0 and 5 Volts that corresponds to the Air Velocity and Temperature measured by the instrument. The output range, pin assignments, and wire colors are given in the table below. Also shown is a block diagram of the analog output circuit.

Wire Color	Pin #	Function	Analog Output Voltage Range	Corresponding Measurement Range	Equation* to convert from Volts (V) to Measurement Value
BLK	1	Ground	--- N/A ---	--- N/A ---	--- N/A ---
GRN	2	Air Velocity	0 to 5 Volts	0 to 10,000 FPM	Air Velocity = 2000×V
GRY	3	--- Not Used ---	--- N/A ---	--- N/A ---	--- N/A ---
WHT	4	Temperature	0 to 5 Volts	-20°C to 80°C	Temperature [°C] = 20×V - 20

*To convert from Volts to Air Velocity in Feet per Minute, multiply by 2000.

- ▶ For example, an analog output of 2.375 Volts on the green wire means that the instrument is measuring an air velocity of 4750 feet per minute (FPM).
- ▶ $2.375 \text{ Volts} \times 2000 = 4750 \text{ FPM}$

*To convert from Volts to Temperature in degrees Celsius (°C), multiply by 20 and subtract 20.

- ▶ For example, an analog output of 3.458 Volts on the white wire means that the instrument is measuring a temperature of 49.16 °C.
- ▶ $3.458 \text{ Volts} \times 20 - 20 = 49.16 \text{ °C}$



Note: When using analog outputs, there is an **additional $\pm 1\%$ error** in the analog output voltage. This is in addition to the normal measurement error.

- ▶ For example, an air velocity reading of 500 FPM would normally have an accuracy of $\pm 1\%$ of reading ± 1 digit (± 6 FPM) when the data is viewed on the LCD display.
- ▶ With the additional error associated with the analog output voltage, the effective accuracy of the analog output for this air velocity measurement will be $\pm 2\%$ of reading ± 1 digit (± 11 FPM).

Custom Analog Voltage Outputs are also available – contact Kanomax for details.

Analog Output circuit block diagram and connector pin assignment

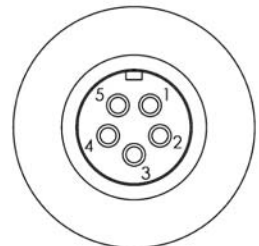
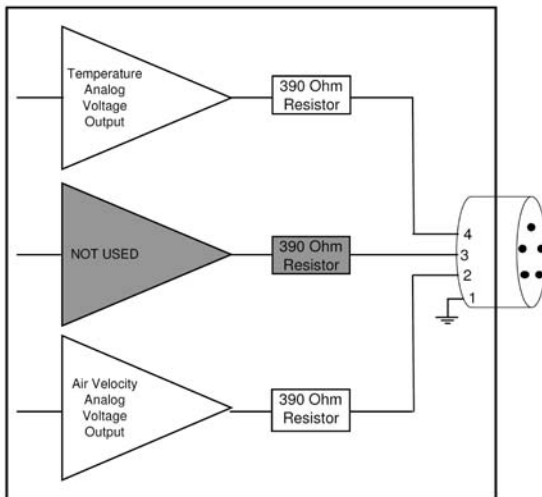

ANALOG OUTPUT CONNECTOR
PINOUT DIAGRAM

Mating Cable Connector:
Binder Part No. 99-0413-00-05



APPENDIX E - USB DATA OUTPUT (IF EQUIPPED)

If the instrument is equipped with the USB Communications option, there will be a four pin male connector on the bottom of the instrument. Also, a USB cable will be included with the instrument. This cable will have a four pin female connector on one end and a USB Type-A connector on the other end.

USB Data Output – Instructions for Use

STEP 1: Install a Virtual COM Port (VCP) Driver on your computer. Free VCP drivers can be downloaded for Windows, Linux, and MAC from FTDI Ltd on their website:

<http://www.ftdichip.com/Drivers/VCP.htm>

We recommend downloading the setup executable, which automatically runs and configures the drivers for you.

STEP 2: Connect the USB cable (included) to the male connector on the bottom of your instrument. Connect the other end to a USB port on your computer.

STEP 3: Turn the Instrument ON.

STEP 4: Verify that the Instrument has been set up as a USB Serial Port with a unique COM port number. (You only need to do this once)

For Windows users, open the Windows Device Manager (found in Control Panel) and verify that a USB serial port exists as shown below.

NOTE: Units with USB or RS232 communications, output only Air data at this time. Temperature & Humidity data is not available on the output.



219 Route 206
PO Box 372
Andover, NJ 07821 USA

Phone: 1-800-247-8887
Fax: (973) 786-7586
info@kanomax-usa.com

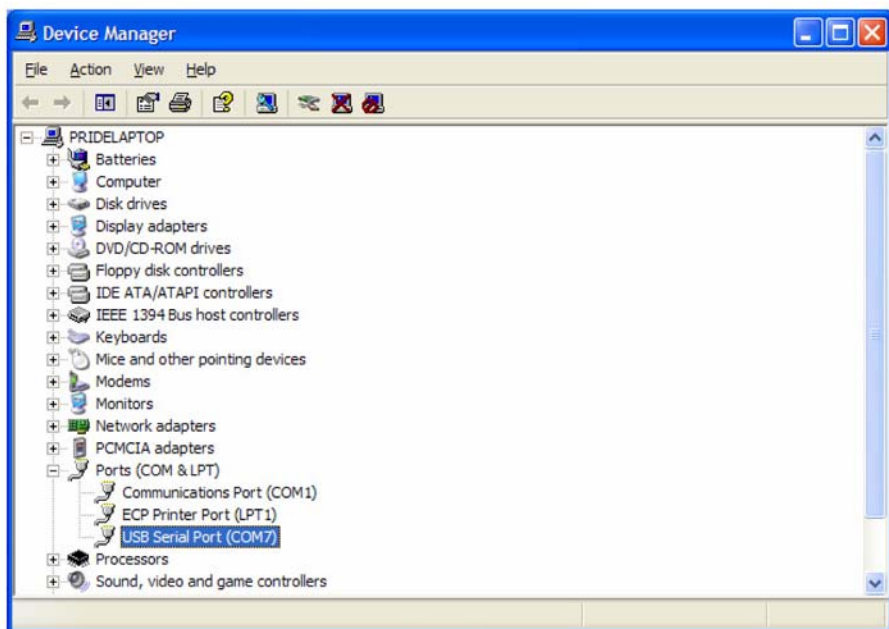

You are now ready to capture the data being measured by your instrument.

Please refer to **Appendix G – Viewing and Capturing Data** for further instructions.



APPENDIX F – RS232 COMMUNICATIONS (IF EQUIPPED)

If the instrument is equipped with the RS232 Communications option, there will be a three pin male connector on the bottom of the instrument. Also, an RS232 cable will be included with the instrument. This cable will have a three pin female connector on one end and a DB9 Female connector on the other end.

RS232 Data Output – Instructions for Use

STEP 1: Connect the RS232 cable (included) to the female connector on the bottom of your instrument. Connect the other end to an RS232 port on your computer.

STEP 3: Turn the Instrument ON.

STEP 4: Verify that the Instrument has been set up as a RS232 Serial Port with a unique COM port number. (You only need to do this once). For Windows users, open the Windows Device Manager (found in Control Panel) and verify that a serial port exists.

You are now ready to capture the data being measured by your instrument.

Please refer to **Appendix G – Viewing and Capturing Data** for further instructions.

APPENDIX G – VIEWING AND CAPTURING DATA (IF EQUIPPED WITH EITHER USB OR RS232 OUTPUTS)

There are many ways to capture the serial port data from the Kanomax Instrument. The simplest method is to use a terminal emulator program.

Using a terminal emulator allows the serial COM port to be opened, with the above port settings, and real-time data to be viewed from the instrument. One such terminal emulator program is Windows HyperTerminal.

To launch Windows HyperTerminal, go to:
START → All Programs → Accessories → Communications → HyperTerminal

Enter a name for the Connection, such as “Kanomax 6812” and choose an icon.



Click OK.

On the next window, next to “Connect using,” select the COM port you that you are using with your instrument. Click OK.



In the next window, select the port settings as shown below and click OK. (The Serial Port settings are also listed at the end of this section).

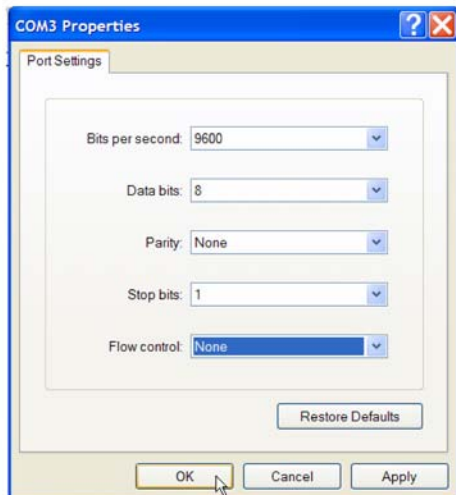

Click on File → Properties. You will see the window shown below. Click on the Settings tab and then click on ASCII Setup... as shown below.

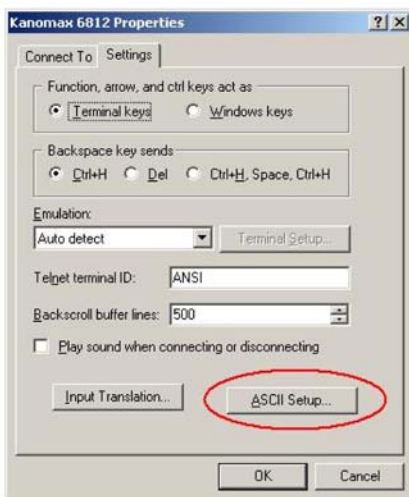

Make sure that "Append line feeds to incoming line ends" is CHECKED as shown below. Click OK.

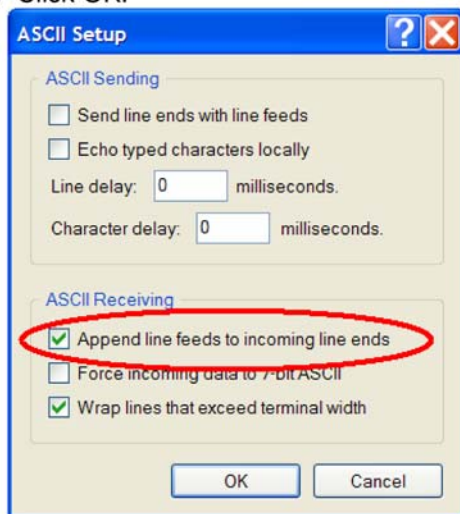

You will now receive data from your instrument. The graphic below shows the serial port output data from Windows HyperTerminal when connected to a Kanomax Instrument.

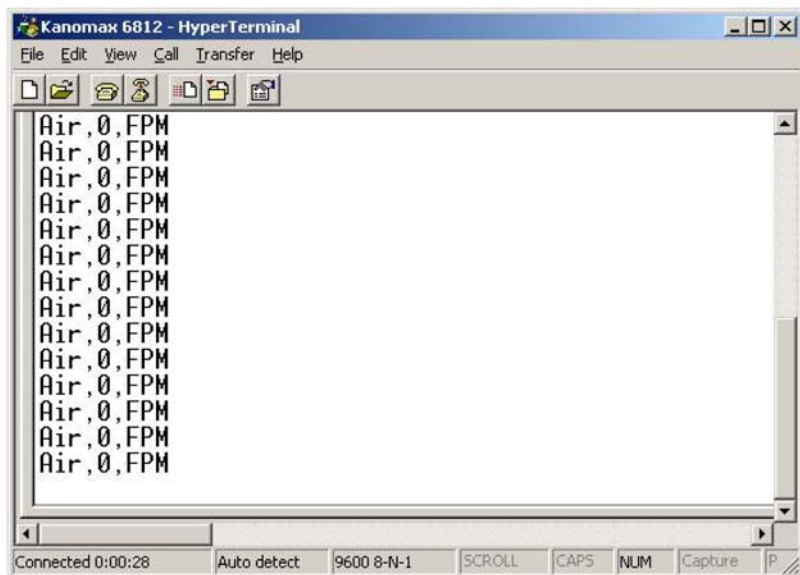

Serial Port Settings

Bits per Second (Baud)	9600
Data bit	8
Parity	None
Stop bits	1
Flow Control	None

Serial Port Protocol

Data Output Interval	One Second
Data Format	Comma-Separated Values (CSV)
Measurement Units	Same as Units shown on LCD Display



Below are examples of the formatted output data for Kanomax's 681x Instruments (units may be different depending on the units selected on the LCD display):

Model 6812 displaying in Air Velocity Mode: Air,47,FPM <CR>
Model 6812 displaying in Volume Flow Mode: Air,251,CFM <CR>

Model 6812: Air,47,FPM <CR>

Model 6813: Air,47,FPM <CR>

NOTE: Units with USB or RS232 communications, output only Air data at this time. Temperature & Humidity data is not available on the output.

Exporting and Graphing Data

Exporting serial port instrument data from the Kanomax Instrument to a spreadsheet application such as Microsoft Excel or OpenOffice Calc allows the data to be graphed or recorded.

The simplest way to export the instrument data is to use a terminal emulator program, like Windows HyperTerminal, and either capture the serial data/text to a file (menu selection) or to manually highlight, copy, and then paste the instrument data into an editor such as Windows Notepad.

Once you have the instrument data in a file, save the file as a .CSV type (e.g., InstrumentData.csv).

Open the file in a spreadsheet application such as Microsoft Excel or OpenOffice Calc. A graph of the data as shown below can now be generated.

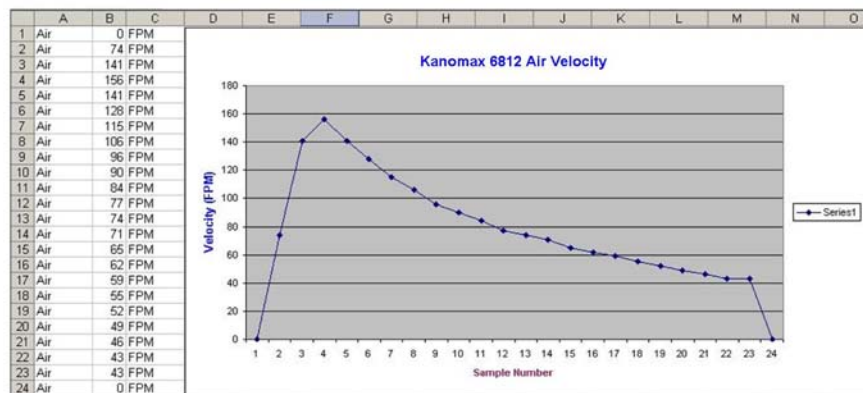

**KANOMAX**

TM

219 Route 206
PO Box 372
Andover, NJ 07821 USA

Phone: 1-800-247-8887
Fax: (973) 786-7586
info@kanomax-usa.com

CALIBRATION

To maintain your instrument in top working order, we recommend that you send it back to us for calibration each year, beginning one year after purchase.

Our calibration services include ensuring the instrument performs within its accuracy tolerance, making any necessary adjustments, and inspecting all aspects of the instrument's functionality so that you'll have another year of dependable service. Calibration also includes a complimentary firmware upgrade so that you know you'll have the latest advances in accuracy and reliability in your instrument.

NIST-Traceable multi-point calibration is also available from the factory. We can offer precise calibration tailored to your specific measurement needs using our state-of-the-art facilities and calibration equipment.

Please contact us or visit our website for the latest information on calibrating your instrument.



219 Route 206
PO Box 372
Andover, NJ 07821 USA

Phone: 1-800-247-8887
Fax: (973) 786-7586
info@kanomax-usa.com



KANOMAX
The Ultimate Measurements

Kanomax USA, Inc.
219 Route 206
PO Box 372
Andover, New Jersey 07821
USA
(800) 247-8887
Fax: (973) 786-7586
info@kanomax-usa.com

www.kanomax-usa.com

Copyright © 2008, Kanomax USA, Inc