

INSTRUCTION MANUAL

MW306 MAX

EC / TDS / NaCl / Temperature
Portable Meter





THANK YOU for choosing Milwaukee Instruments!

This instruction manual will provide you the necessary information for correct use of the meter.

All rights are reserved. Reproduction in whole or in part is prohibited without the written consent of the copyright owner, Milwaukee Instruments Inc., Rocky Mount, NC 27804 USA.

TABLE OF CONTENTS

1. PRELIMINARY EXAMINATION	4
2. INSTRUMENT OVERVIEW	5
3. SPECIFICATIONS	6
4. FUNCTIONAL & DISPLAY DESCRIPTION.....	8
5. MA815D/1 PROBE DESCRIPTION.....	11
6. GENERAL OPERATIONS.....	12
6.1. BATTERY MANAGEMENT & REPLACEMENT.....	12
6.2. CONNECTING THE PROBE.....	13
6.3. ELECTRODE CARE & MAINTENANCE.....	13
7. SETUP	14
7.1. SETUP OPTIONS.....	14
8. EC / TDS	23
8.1. PREPARATION	23
8.2. CALIBRATION	23
8.3. MEASUREMENT.....	26
8.4. WARNINGS & MESSAGES.....	28
9. SALINITY	30
9.1. PREPARATION	30
9.2. CALIBRATION	30
9.3. MEASUREMENT.....	31
9.4. WARNINGS & MESSAGES.....	33
10. LOGGING	35
10.1. TYPES OF LOGGING	35
10.2. DATA MANAGEMENT	38
11. GLP	45
11.1. EC/TDS INFORMATION	45
11.2. %NaCl INFORMATION.....	45
12. TROUBLESHOOTING.....	46
13. ACCESSORIES.....	47
CERTIFICATION.....	48
RECOMMENDATION	48
WARRANTY.....	49

1. PRELIMINARY EXAMINATION

MW306 portable meter is delivered in a rugged carrying case and is supplied with:

- **MA815D/1** 4-ring EC / TDS / NaCl / Temperature probe with DIN connector and 1 meter (3.2 feet) cable
- 1.5V alkaline AA battery (3 pcs.)
- Micro USB cable
- Instrument quality certificate
- Instruction manual

2. INSTRUMENT OVERVIEW

MW306 is a portable water-resistant meter that can measure up to four different parameters – EC, TDS, salinity (in PSU, g/L, percentage NaCl and temperature.

- Easy to read LCD display
- Auto-off feature to prolong battery life
- All measurements can be temperature compensated automatically (ATC), or manually (MTC) with a user-selectable compensation coefficient. Temperature compensation can be disabled (NO TC) if the actual conductivity value is required.
- The auto-ranging feature for both EC and TDS measurements automatically sets the most suitable resolution for the tested sample.
- Available log space for up to 1000 records
- Logged data can be exported using a USB cable
- Dedicated GLP key to store and recall data on system status

3. SPECIFICATIONS

Range *	EC	0.00 to 29.99 $\mu\text{S}/\text{cm}$
		30.0 to 299.9 $\mu\text{S}/\text{cm}$
		300 to 2999 $\mu\text{S}/\text{cm}$
		3.00 to 29.99 mS/cm
		30.0 to 200.0 mS/cm
		up to 500.0 mS/cm , absolute conductivity **
TDS (with 0.5 factor)	0.00 to 14.99 ppm (mg/L)	
	15.0 to 149.9 ppm (mg/L)	
	150 to 1499 ppm (mg/L)	
	1.50 to 14.99 g/L	
	15.0 to 100.0 g/L	
		up to 250.0 g/L absolute TDS **
		up to 400.0 g/L absolute TDS ** (with 0.8 factor)
Salinity	0.0 to 400.0 % NaCl	
	2.00 to 42.00 PSU	
	0.00 to 80.00 g/L	
Temp.	-20.0 to 120.0 °C (-4.0 to 248.0 °F)	
Resolution	EC	0.01 $\mu\text{S}/\text{cm}$
		0.1 $\mu\text{S}/\text{cm}$
		1 $\mu\text{S}/\text{cm}$
		0.01 mS/cm
		0.1 mS/cm
TDS	0.01 ppm	
	0.1 ppm	
	1 ppm	
	0.01 g/L	
	0.1 g/L	
Salinity	0.1% NaCl	
	0.01 PSU	
	0.01 g/L	
Temp.	0.1 °C (0.1 °F)	
Accuracy * @ 25 °C (77 °F)	EC	$\pm 1\%$ of reading
		($\pm 0.05 \mu\text{S}/\text{cm}$ or 1 digit, whichever is greater)
	TDS	$\pm 1\%$ of reading
		($\pm 0.03 \text{ ppm}$ or 1 digit, whichever is greater)
	Salinity	$\pm 1\%$ of reading
Temperature accuracy *	$\pm 0.5 \text{ °C}$ ($\pm 0.9 \text{ °F}$)	

* Limits will be reduced to actual sensor limits.

** Absolute conductivity (or TDS) is the conductivity (or TDS) value without temperature compensation.

Calibration	EC / TDS	Single cell factor calibration 6 standards: 84 µS/cm, 1413 µS/cm, 5.00 mS/cm, 12.88 mS/cm, 80.0 mS/cm, 111.8 mS/cm One-point offset: 0.00 µS/cm
	Salinity	One-point with MA9066 Salinity calibration solution
	Temp.	No temperature calibration
Temperature compensation		ATC – automatic MTC – manual, without temperature probe -20.0 to 120.0 °C (-4.0 to 248.0 °F) NO TC – without temperature compensation
Conductivity temp. coefficient		0.00 to 6.00 % / °C (EC & TDS only) Default value: 1.90 % / °C
TDS factor		0.40 to 0.80 Default value: 0.50
Logging memory		Max. 1000 log records (stored in up to 100 lots) On demand, 200 logs On stability, 200 logs Interval logging, 1000 logs
PC connectivity		1 micro USB port
Battery type		3 x 1.5V alkaline AA (included)
Battery life		Approx. 200 hours of use
Environment		0 to 50 °C; maximum RH 95%
Dimensions		200 x 85 x 50 mm (7.9 x 3.3 x 2.0")
Casing		IP67 protection level
Weight		260 g (0.57 lb)

PROBE SPECIFICATIONS

EC probe MA815D/1	Temperature range	0 to 60 °C (32 to 140 °F)
	Temperature sensor	NTC10K
	4-ring type	Stainless steel
	Connector socket	DIN, 7 pins
	Body	ABS
	Dimensions	total length: 198 mm (7.8") active part: 96 mm (3.8") Ø 16 mm (0.63")
	Cable length	1 m (3.2 ft)

4. FUNCTIONAL & DISPLAY DESCRIPTION

Front Panel

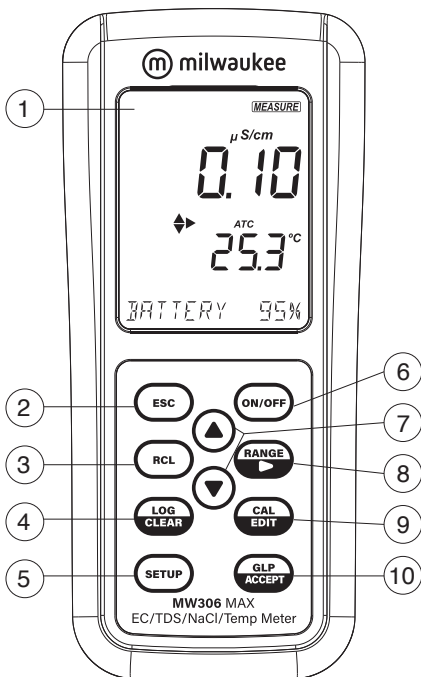

1. Liquid Crystal Display (LCD)
2. ESC key, to exit current mode
3. RCL key, to recall the logged values
4. LOG/CLEAR key, to log the reading or to clear calibration or logging
5. SETUP key, to enter setup mode
6. ON/OFF key
7. ▲▼ directional keys (menu navigation, setting parameters)
8. RANGE/▶ key, to select EC, TDS or Salinity
9. CAL/EDIT key, to enter or edit calibration settings, setup settings
10. GLP/ACCEPT key, to enter GLP or to confirm selected action

Top Panel

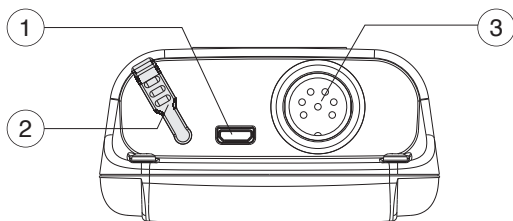

- 1. Micro USB port
- 2. Micro USB port cap
- 3. DIN probe connector

Display Description

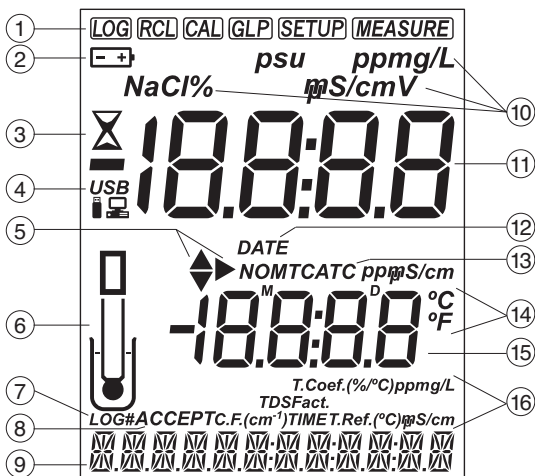

1. Mode tags
2. Battery status
3. Stability indicator
4. USB connection status
5. Arrow tags, to navigate the menu in either direction
6. Probe symbol
7. Log tag
8. Accept tag
9. Third LCD line, message area
10. Measurement units
11. First LCD line, measurement readings
12. Date tag
13. Temperature compensation status (NO TC, MTC, ATC)
14. Temperature units
15. Second LCD line, temperature readings
16. Measurement units / TDS settings

5. MA815D/1 PROBE DESCRIPTION

Main features:

- Direct signal processing for noise-free measurements
- Accurate and integrated temperature measurement

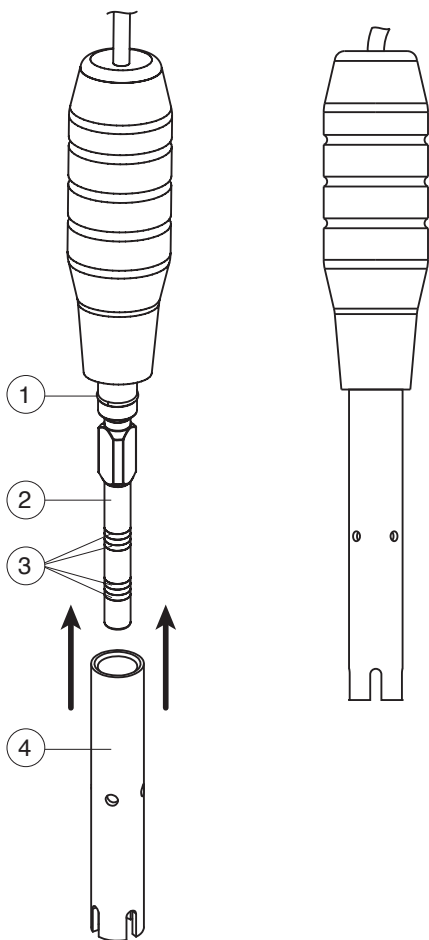

1. O-ring
2. Plastic insulator
3. Steel rings
4. Probe sleeve

6. GENERAL OPERATIONS

6.1. BATTERY MANAGEMENT & REPLACEMENT

The meters are supplied with 3 x 1.5V alkaline AA batteries and equipped with Battery Error Prevention System (BEPS) feature, which turns the meter off after 10 minutes of non-use (see SETUP OPTIONS, Auto Off section).

At power on, the instruments perform an auto-diagnostic test and all LCD segments are displayed for a few seconds.

Use ▲▼ keys to check the battery percentage.

To replace the batteries

1. Turn the meter off.
2. Remove the 4 screws on the back of the meter to open the battery compartment.
3. Remove the old batteries.
4. Insert the three new 1.5V AA batteries while paying attention to their polarity.
5. Close the battery compartment using the 4 screws.

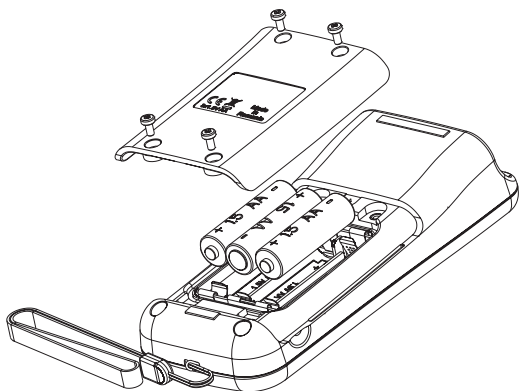

6.2. CONNECTING THE PROBE

MA815D/1 is connected to the meter through a DIN connector, making attaching and removing the probe an easy process.

- With the meter off, connect the probe to the DIN socket on the top of the meter.
- Align the pins and key then push the plug into the socket.

After measurement, power off the meter and clean the probe before storage.

6.3. ELECTRODE CARE & MAINTENANCE

When using a new probe, remove the sleeve and inspect the probe prior to use.

Calibrating

Calibration is the first step in obtaining accurate and repeatable results. See CALIBRATION section for details.

Best practice

- Always use fresh standards. The calibration standards are easily contaminated.
- Do not reuse standards.
- Do not use expired standards.

Regular Maintenance

- Inspect the probe for cracks or other damage. Replace the probe if necessary.
- Inspect sensor o-ring for nicks or other damage.
- Inspect the cable. Cable and insulation must be intact.
- Connectors should be clean and dry.
- Follow storage recommendation.

Cleaning Procedure

If a more thorough cleaning is required, remove the sleeve and clean the probe with a cloth and a nonabrasive detergent. Reinsert the sleeve and recalibrate the probe.

Storage

EC probes should always be stored clean and dry.

7. SETUP

To configure the meter settings, modify default values or set measurement parameters:

- Press SETUP to enter (or exit) Setup mode
- Use ▲▼ keys to navigate the menus (view parameters)
- Press CAL/EDIT to enter Edit mode (modify parameters)
- Press RANGE/▶ key to select between options
Use ▲▼ keys to modify values (value being modified is displayed blinking)
- Press GLP/ACCEPT to confirm and save changes (ACCEPT tag is displayed blinking)
- Press ESC (or CAL/EDIT again) to exit Edit mode without saving (return to menu)

7.1. SETUP OPTIONS

Log Type

Options: INTERVAL (default), MANUAL or STABILITY

Press RANGE/▶ to select between options.

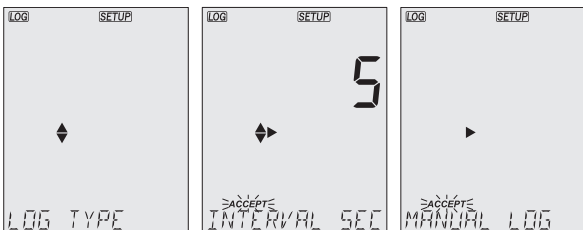

Use ▲▼ keys to set time interval: 5 (default), 10, 30 sec. or 1, 2, 5, 15, 30, 60, 120, 180 min.

Use ▲▼ keys to select stability type: fast (default), medium or accurate.

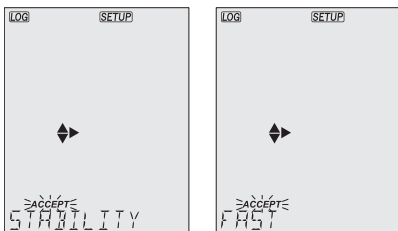

Calibration Expired Warning

Options: 1 to 7 days (default) or off

Use ▲▼ keys to select the number of days since last calibration has elapsed.

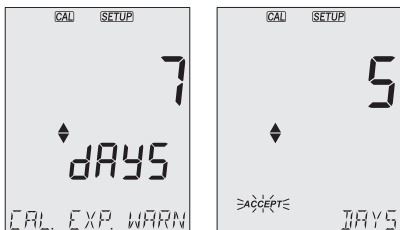

Temperature Compensation

Options: ATC (default), MTC or NO TC

With the probe connected, press RANGE/▶ to select options.

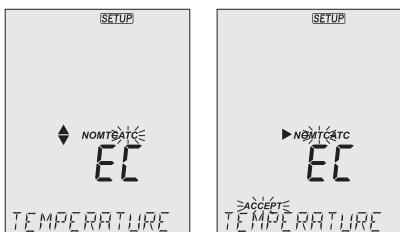

EC Cell Factor

Options: 0.010 (default) to 9.999

With the probe connected, use ▲▼ keys to change the value.

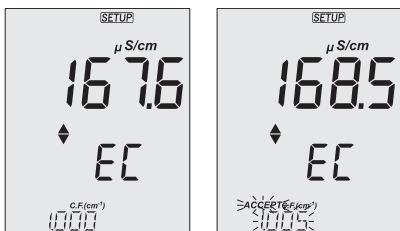

Note: Setting the EC cell-factor value directly will erase any previous calibrations. Log files and GLP will display "MANUAL" as standard.

EC Temperature Coefficient (T.Coef.)

Options: 0.00 to 6.00 (1.90 default)

With the probe connected, use ▲▼ keys to change the value.

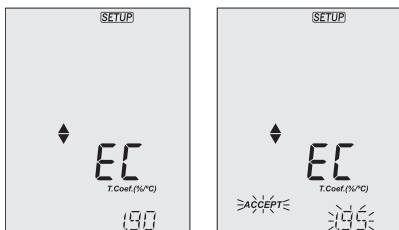

EC Temperature Reference (T.Ref.)

Options: 25 °C (default) and 20 °C

With the probe connected, use ▲▼ keys to change the value.

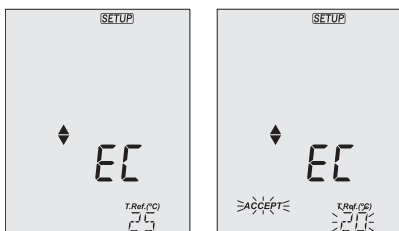

TDS Factor

Options: 0.40 to 0.80 (0.50 default)

With the probe connected, use ▲▼ keys to change the value.

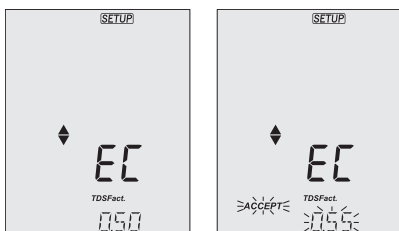

EC Temperature Coefficient / Reference View

Options: T.Coef.(%/°C) or T.Ref.(°C) (default)

With the probe connected, use ▲▼ keys to change between Temperature Coefficient and Temperature Reference.

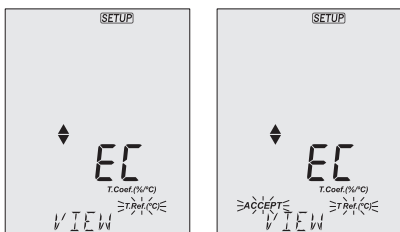

EC Range

Options: AUTO (default), 29.99 $\mu\text{S}/\text{cm}$, 299.9 $\mu\text{S}/\text{cm}$, 2999 $\mu\text{S}/\text{cm}$, 29.99 mS/cm , 200.0 mS/cm

Note: Absolute conductivity – up to 500.0 mS/cm – is the conductivity value without temperature compensation.

With the probe connected, use ▲▼ keys to change the value. When autoranging, the meter automatically chooses the optimum conductivity range to maintain the highest possible accuracy.

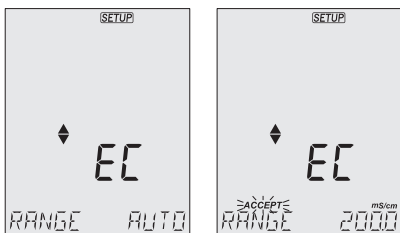

Note: Selected EC range is active during measurements only. If exceeded, the full-scale value is displayed blinking. Logged data is displayed in $\mu\text{S}/\text{cm}$ in the CSV files.

TDS Range

Options: AUTO (default), 14.99 mg/L , 149.9 mg/L , 1499 mg/L , 14.99 g/L , 100.0 g/L

Note: Absolute TDS – up to 400.0 g/L (with 0.8 factor) – is the TDS value without temperature compensation.

With the probe connected, use ▲▼ keys to change the value. When autoranging, the meter automatically chooses the optimum TDS range to maintain the highest possible accuracy.

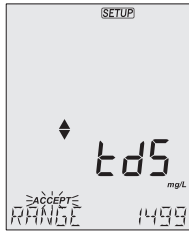

Note: Selected TDS range is active during measurements only. If exceeded, the full-scale value is displayed blinking. Logged data is displayed in mg/L in the CSV files.

TDS Unit

Options: ppm (mg/L) default and g/L

With the probe connected, press RANGE/▶ to select options.

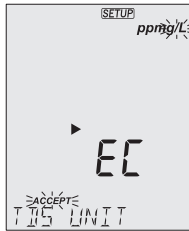
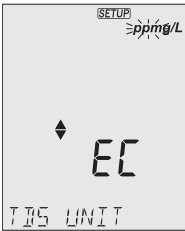

Salinity Scale

Options: NaCl% (default), psu and g/L

With the probe connected, press RANGE/▶ to select options.

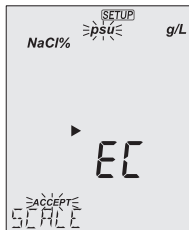
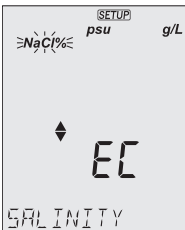

Date

Options: year, month or day

Press RANGE/▶ to select. Use ▲▼ keys to modify the values.

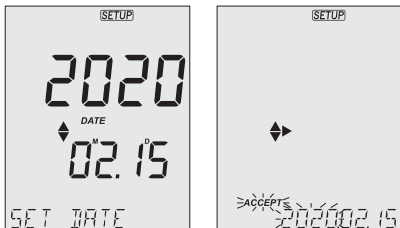

Time

Options: hour, minute or second

Press RANGE/▶ to select. Use ▲▼ keys to modify the values.

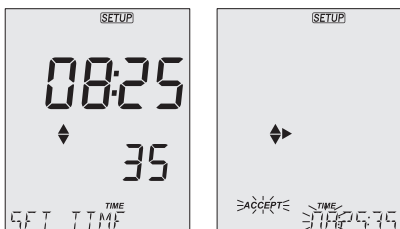

Auto Off

Options: 5, 10 (default), 30, 60 minutes or off

Use ▲▼ keys to select the time.

The meter will power off after set period of time.

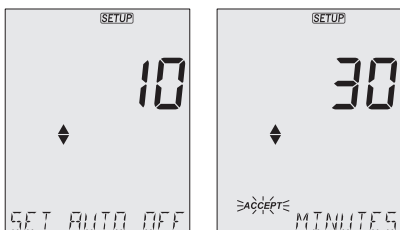

Sound

Options: enable (default) or disable

Use ▲▼ keys to select.

When pressed, each key will emit a short acoustic signal.

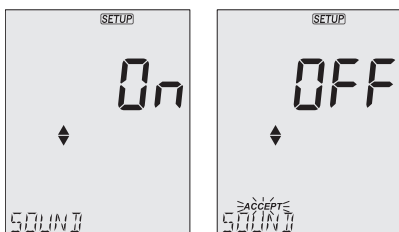

Temperature Unit

Options: °C (default) or °F

Use ▲▼ keys to select the unit.

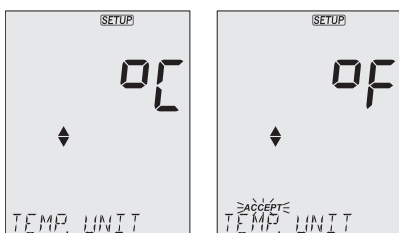

LCD Contrast

Options: 1 to 9 (default)

Use ▲▼ keys to select LCD contrast values.

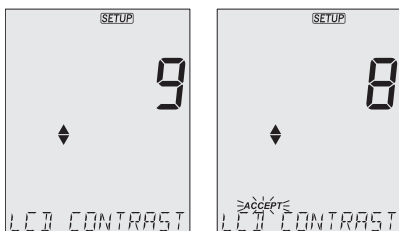

Default Values

Resets meter settings to factory defaults.

Press GLP/ACCEPT to restore the default values. "RESET DONE" message confirms that the meter performs with default settings.



Instrument Firmware Version

Displays the installed firmware version.



Meter ID / Serial Number

Use ▲▼ keys to assign a meter ID from 0000 to 9999

Press RANGE/▶ to view the serial number.

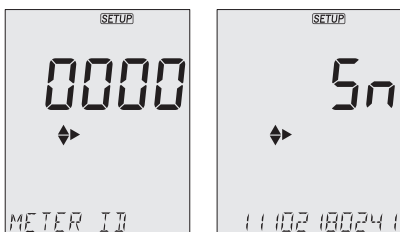

Separator Type

Option: comma (default) or semicolon

Use ▲▼ keys to select the columns separator for the CSV file.

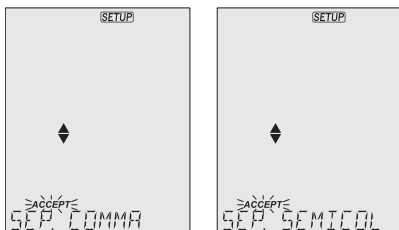

Export to PC / Log on Meter

Options: Export to PC and Log on Meter

With the micro USB cable connected, press SETUP. Press CAL/EDIT to enter Edit mode. Use ▲▼ keys to select.

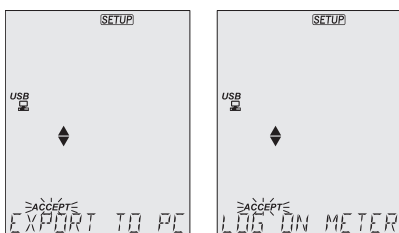

Note: This option is only available while connected to a PC. The USB/PC icon is not displayed if LOG ON METER option was previously set.

8. EC / TDS

8.1. PREPARATION

Pour small quantities of conductivity calibration solution into clean beakers. To minimize cross-contamination, use two beakers: one for rinsing the probe and the other for calibration.

Note: At power on the meter starts measuring with the previously selected range (conductivity, TDS or salinity).

Note: A new EC calibration automatically clears the %NaCl calibration. "NO CAL" message is displayed blinking.

8.2. CALIBRATION

General Guidelines

For better accuracy frequent calibration is recommended. The probe should be calibrated:

- Whenever is replaced
- After testing aggressive samples
- When high accuracy is required
- If "NO CAL" is displayed on the third LCD line
- At least once a week

Before performing a calibration:

- Inspect the probe for debris or blockages.
- Always use an EC calibration standard that is close to the sample. Selectable calibration points are 0.00 μS for offset and 84 $\mu\text{S}/\text{cm}$, 1413 $\mu\text{S}/\text{cm}$, 5.00 mS/cm , 12.88 mS/cm , 80.0 mS/cm , 111.8 mS/cm for slope.

To enter EC calibration:

1. Use the ▲▼ keys to elect the EC range and press CAL/EDIT. When the reading is stable and close to the selected calibration standard, STD and ACCEPT tags are displayed blinking.
2. Press GLP/ACCEPT key to confirm calibration. The instrument displays "SAVING", stores calibration values and returns to measurement mode.

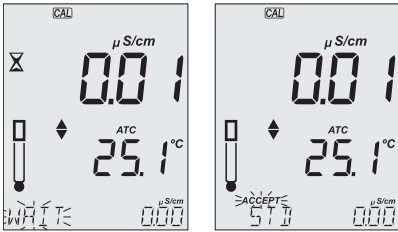

Zero Calibration

For zero calibration, to correct readings around 0.00 $\mu\text{S}/\text{cm}$, keep the dry probe in the air. The slope is evaluated when the calibration is performed in any other point.

One-Point Calibration

1. Place the probe in the calibration solution making sure that the sleeve holes are completely submersed. Center the probe away from the bottom or beaker walls.
2. Lift and lower the probe to refill the center cavity and tap the probe repeatedly to remove any air bubbles that may have been trapped inside the sleeve.
3. Press CAL/EDIT to enter calibration. Use the ▲▼ keys to select a different standard value. The hourglass symbol and "WAIT" message (blinking) are displayed until the reading is stable.

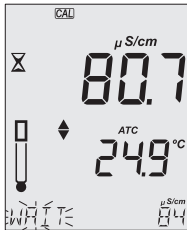

4. When reading is stable and close to the selected calibration standard, SOL STD and ACCEPT tags are displayed blinking.

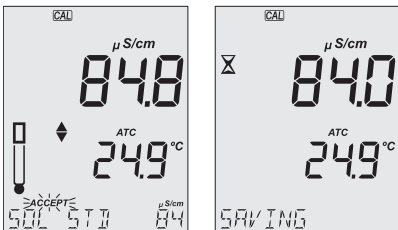

- Press GLP/ACCEPT key to confirm calibration. The instrument displays "SAVING", stores the calibration values and returns to measurement mode.

Note: The TDS reading is automatically derived from the EC reading and no calibration is needed.

Manual Calibration

This option may be used to perform a manual calibration in a custom standard, i.e. to set the cell-constant value directly.

To minimize cross-contamination, use two beakers: one for rinsing the probe and the other for calibration.

- Rinse the probe in the calibration standard and shake off any excess solution (first beaker).
- Place the probe in the standard ensuring that the sleeve holes are covered with solution (second beaker).
- Press SETUP and use the ▲▼ keys to select C.F. (cm⁻¹).
- Press CAL/EDIT.
- Use the ▲▼ keys to modify C.F. (cm⁻¹) until the display reads the Custom Standard value.
- Press GLP/ACCEPT. "MANUAL CALIBRATION CLEARS PREVIOUS CALIBRATIONS" is displayed on the third LCD line. CAL and ACCEPT tags are displayed blinking.
- Press GLP/ACCEPT to confirm or press ESC to exit without changing.

Note: Using manual calibration will erase previous calibrations; and both log files and GLP will display "MANUAL" as standard.

Clear Calibration

Press CAL/EDIT to enter Calibration mode, then press LOG/CLEAR. ACCEPT tag is displayed blinking and "CLEAR CALIBRATION" message on the third LCD line.

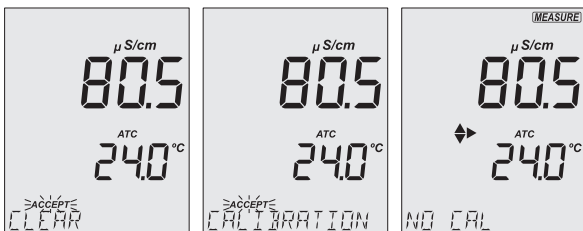

To confirm, press GLP/ACCEPT. "PLEASE WAIT" message is displayed followed by "NO CAL" confirmation screen.

8.3. MEASUREMENT

Conductivity Measurement

When connected, the **MA815D/1** probe is automatically recognized. Place the calibrated probe in the sample, making sure that the sleeve holes are completely submerged. Tap the probe to remove any air bubbles that may be trapped inside the sleeve.

To change to EC mode, press RANGE/▶.

The conductivity value is displayed on the first LCD line, the temperature on the second LCD line and calibration or range-specific information on the third LCD line.

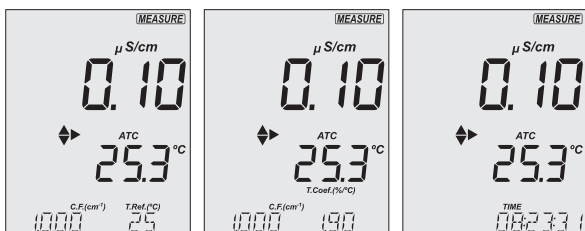

To toggle between information displayed on the third LCD line, use the ▲▼ keys.

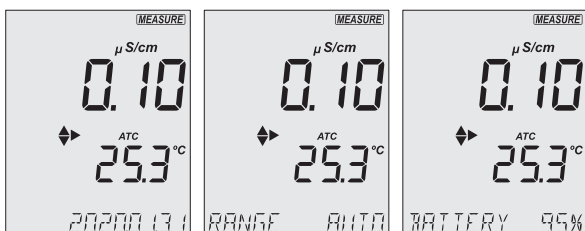

Readings can be temperature compensated.

- **Automatic Temperature Compensation (ATC), default:** The probe has a built-in temperature sensor; the temperature value is used to automatically compensate the EC / TDS reading.

When in ATC mode, ATC tag is displayed and measurements are compensated using the temperature coefficient. Recommended default value for water samples is 1.90% / $^{\circ}\text{C}$. Temperature compensation is referenced to the selected reference temperature.

Use the ▲▼ keys to view the current temperature coefficient. The value is displayed along with the Cell Factor (C.F.) on the third LCD line.

To change the temperature coefficient, see SETUP section for details.

A temperature coefficient must also be set for the sample.

Note: If the reading outside of range when the range is set to automatic, the full-scale value (200.0 mS/cm for MTC/ATC or 500.0 mS/cm for No TC) is displayed blinking.

- **Manual (MTC):** The temperature value, shown on the second LCD line, can be manually set using the ▲▼ keys. When in MTC mode, the °C tag is displayed blinking.
- **No Temperature Compensation (NO TC):** The temperature value is displayed, but not taken into account. When this option is selected, the NO TC tag is displayed. The reading displayed on the first LCD line is the uncompensated EC or TDS value.

Note: Temperature-compensation and absolute conductivity (NO TC) are configured in Setup.

TDS Measurement

Press RANGE/▶ to select TDS range.

- The TDS reading is displayed on the first LCD line and the temperature reading on the second LCD line.
- Measured value is displayed in the set parameter unit (ppm or mg/L). Values above 1500 ppm (1500 mg/L) are displayed only in g/L unit. See SETUP section for details.

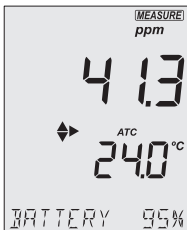

To toggle between information displayed on the third LCD line, use the ▲▼ keys.

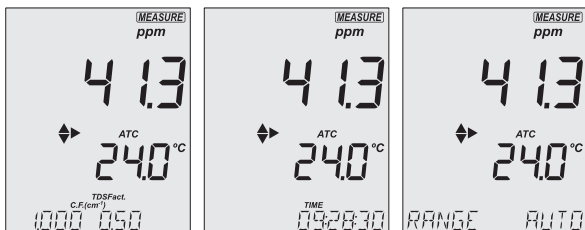

- If the reading is out of range, the full-scale value is displayed blinking.

8.4. WARNINGS & MESSAGES

Messages Displayed During Calibration

- If the reading exceeds expected value, "WRONG STANDARD" message is displayed and calibration can not be confirmed. Check that correct calibration solution has been used and / or clean the probe. See PROBE MAINTENANCE section for details.
- When using ATC mode, if the temperature of the solution is outside the accepted interval, the "WRONG STANDARD TEMPERATURE" message is displayed. The °C tag and the temperature are displayed blinking.

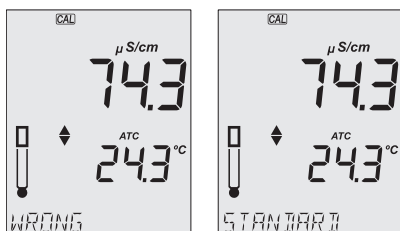

Messages Displayed During Measurement

- If the EC measurement exceeds the specified limits or the temperature exceeds (-20 to 120°C), "OUT OF SPEC" message is displayed on the third LCD line.
- If the EC measurement exceeds the user-selected range the "OVER RANGE" message is displayed on the third LCD line.

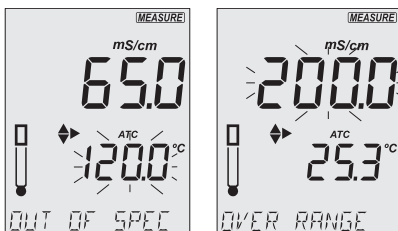

- "NO CAL" message indicates that the probe needs to be calibrated or that the previous calibration has been deleted.
- If the probe is not connected, "NO PROBE" message is displayed.

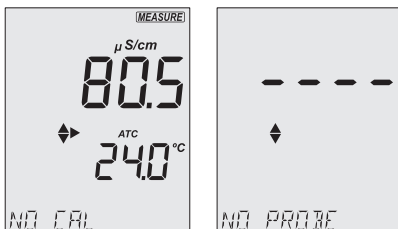

Messages Displayed During Interval Logging

- If EC temperature exceeds the limit of the probe or meter specifications, "OUT OF SPEC" message is displayed alternatively with the Log specific messages.
- If the probe sensor is disconnected or damaged, logging stops with "Log end - Probe disconnected" message in the log file. "NO PROBE" message is displayed on the LCD.

9. SALINITY

9.1. PREPARATION

Pour small quantities of **MA9066** salinity calibration solution into clean beakers. To minimize cross-contamination, use two beakers: one for rinsing the probe and the other for calibration.

Note: When the meter is switched on, it starts measuring with the previously selected range (conductivity, TDS or salinity).

Note: A new EC calibration automatically clears the %NaCl calibration. "NO CAL" message is displayed.

9.2. CALIBRATION

Press RANGE/▶ to select Salinity mode. %NaCl tag is displayed. %NaCl calibration is a one-point calibration at 100.0% NaCl.

Place the probe in the calibration solution making sure that the sleeve holes are completely submersed. Center the probe away from the bottom or beaker walls.

Lift and lower the probe to refill the center cavity and tap the probe repeatedly to remove any air bubbles that may have been trapped inside the sleeve.

Press CAL/EDIT to enter to calibration mode. The CAL tag is displayed at the top of the screen. The first LCD line displays the NaCl reading and the third LCD line the closest calibration point.

The hourglass symbol and "WAIT" message (blinking) are displayed until the reading is stable.

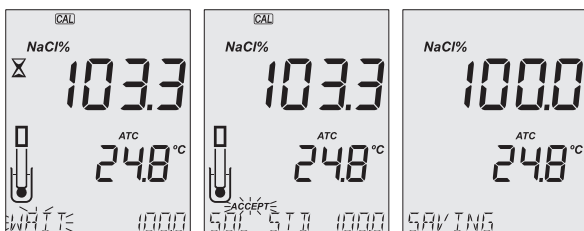

When the reading is stable and close to the selected calibration standard, "SOL STD" message and ACCEPT tag (blinking) are displayed. Press GLP/ACCEPT key to confirm calibration.

The instrument displays "SAVING", stores the calibration values and returns to Measurement mode.

9.3. MEASUREMENT

MW306 supports three seawater salinity scales:

- Practical Salinity Units (PSU)
- Natural Seawater (g/L)
- Percentage (%NaCl)

Press RANGE/▶ to select salinity scales. Verify that the required scale is configured in SETUP.

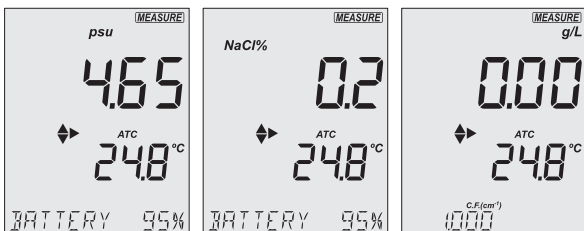

Note: These units are for determining salinity and they refer to general use of saltwater. Practical salinity and natural seawater require a conductivity calibration. %NaCl requires calibration in MA9066 standard.

PSU - Practical Salinity Units

The practical salinity (S) of seawater relates the ratio of electrical conductivity of a standard seawater sample at 15 °C and 1 atmosphere to a potassium chloride solution (KCl) with a mass of 32.4356 g/Kg water at the same temperature and pressure.

The ratio is equal to 1, and $S = 35$. The practical salinity scale may be applied to values to through 42.00 PSU at temperatures between -2 to 35 °C.

Salinity of a sample in practical salinity units (PSU) is calculated using the following formula:

$$R_T = \frac{C_T(\text{sample})}{C(35, 15) \cdot r_T}$$

$$r_T = 1.0031 \cdot 10^{-9} T^4 - 6.9698 \cdot 10^{-7} T^3 + 1.104259 \cdot 10^{-4} T^2 + 2.00564 \cdot 10^{-2} T + 6.766097 \cdot 10^{-1}$$

$$\text{Sal} = \sum_{k=0}^5 a_k \cdot R_T^{\frac{k}{2}} + f(t) \cdot \sum_{k=0}^5 b_k \cdot R_T^{\frac{k}{2}} - \frac{c_0}{1 + 1.5X + X^2} - \frac{c_1 f(t)}{1 + Y^{\frac{1}{2}} + Y^{\frac{3}{2}}}$$

$$f(t) = \frac{T - 15}{1 + 0.0162 \cdot (T - 15)}$$

where:

R_T	ratio of sample conductivity to standard conductivity at Temperature = (T) °C
C_T (sample)	uncompensated conductivity at T °C
$C(35, 15) = 42.914$ mS/cm	the corresponding conductivity of KCl solution containing a mass of 32.4356 g KCl/1 Kg solution
r_T	temperature compensation polynomial

$$a_0 = 0.008$$

$$a_1 = -0.1692$$

$$a_2 = 25.3851$$

$$a_3 = 14.0941$$

$$a_4 = -7.0261$$

$$a_5 = 2.7081$$

$$b_0 = 0.0005$$

$$b_1 = -0.0056$$

$$b_2 = -0.0066$$

$$b_3 = -0.0375$$

$$b_4 = 0.0636$$

$$b_5 = -0.01442$$

$$c_0 = 0.008$$

$$c_1 = 0.0005$$

$$X = 400R_T$$

$$Y = 100R_T$$

%NaCl Percentage

In this scale 100% salinity is equivalent to roughly 10% solids.

If the reading is outside the range, the full-scale value (400.0%) will be displayed blinking.

Natural Sea Water

The Natural Sea Water scale extends from 0.00 to 80.00 g/L. It determines salinity based upon a conductivity ratio of sample to "standard seawater" at 15 °C.

$$R_{15} = \frac{C_T(\text{sample})}{C(35, 15) \cdot r_T}$$

where:

R_{15} is the conductivity ratio

C_T (sample) is uncompensated conductivity at T °C

$C(35, 15) = 42.914$ mS/cm is the corresponding conductivity of KCl solution containing a mass of 32.4356 g KCl/1 Kg solution

r_T is temperature compensation polynomial

Salinity (S) is defined by the following equation:

$$S = -0.08996 + 28.2929729R_{15} + 12.80832R_{15}^2 - 10.67869R_{15}^3 + 5.98624R_{15}^4 - 1.32311R_{15}^5$$

Note: The formula can be applied for temperatures between 10 and 31 °C.

9.4. WARNINGS & MESSAGES

Messages Displayed During Calibration

- If an EC calibration is performed, the %NaCl calibration is automatically cleared. A new %NaCl calibration is required.
- If the reading exceeds expected calibration standard, "WRONG STANDARD" message is displayed and calibration can not be confirmed. Check if the correct calibration solution has been used and / or clean the probe. See PROBE MAINTENANCE section for details.

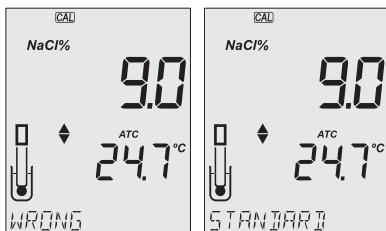

- If the temperature is outside the 0.0 to 60.0 °C range, "WRONG STANDARD TEMPERATURE" message is displayed. Temperature value is displayed blinking.

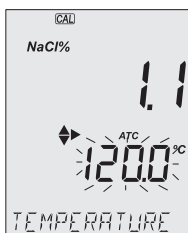

Messages Displayed During Measurement

- If the salinity measurement exceeds the specified limits or the temperature exceeds (-20 to 120°C), "OUT OF SPEC" message is displayed.

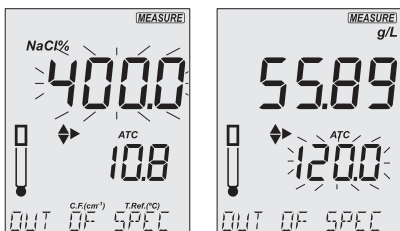

- If a %NaCl calibration is required, "NO CAL" message is displayed.



- If Calibration Expired Warning is on and the number of days set have passed, or an EC calibration was performed (clearing the %NaCl calibration), the "CAL EXPIRED" message is displayed.



- If no probe is connected, "NO PROBE" message is displayed.

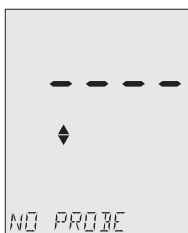

10. LOGGING

MW306 supports three types of logging: manual log on demand, log on stability and interval logging. See Log Type in SETUP OPTIONS section.

The meter can hold up to 1000 log records. Up to 200 for manual log on demand, up to 200 for log on stability and up to 1000 for interval logging. See DATA MANAGEMENT section.

Note: *An interval logging lot can hold up to 600 records. When an interval logging session exceeds 600 records, another log file is automatically generated.*

10.1. TYPES OF LOGGING

Manual log on demand

- Readings are logged each time LOG/CLEAR is pressed
- All manual readings are stored in a single lot (i.e. records made on different days share the same lot)

Log on stability

- Readings are logged each time LOG/CLEAR is pressed and stability criteria is reached
- Stability criteria can be set to fast, medium or accurate
- All stability readings are stored in a single lot (i.e. records made on different days are logged in the same lot)

Interval logging

- Readings are logged continuously at a set time interval (e.g. every 5 or 10 minutes).
- Records are added to it until the session stops.
- For each interval logging session, a new lot is created.

A complete set of GLP information including date, time, range selection, temperature reading and calibration information is stored with each log.

Manual Log on Demand

1. From the Setup mode, set Log Type to MANUAL.
2. From the measurement screen press LOG/CLEAR.
LCD displays "PLEASE WAIT". The LOG ### "SAVED" screen displays stored log number. "FREE" ### screen displays the number of available records.
Meter then returns to measurement screen.

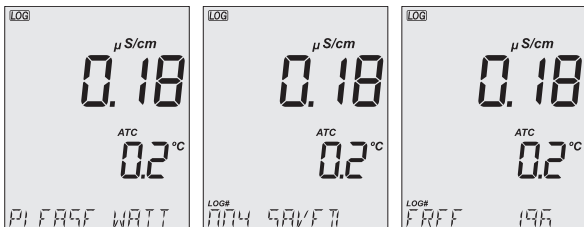

Log on Stability

1. From the Setup mode, set Log Type to STABILITY and the desired stability criteria.
2. From the measurement screen press LOG/CLEAR.
LCD displays "PLEASE WAIT" then "WAITING", until stability criteria is reached.

Note: Pressing ESC or LOG/CLEAR with "WAITING" displayed, exits without logging.

The LOG ### "SAVED" screen displays stored log number. "FREE" ### screen displays total number of available records.
Meter then returns to measurement screen

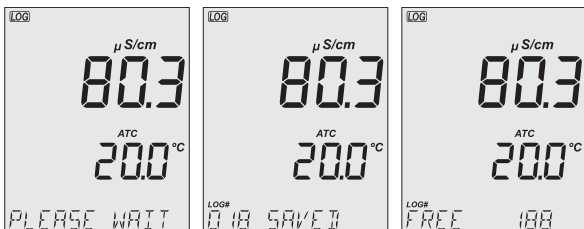

Interval Logging

1. From the Setup mode, set Log Type to INTERVAL (default) and desired time interval.
2. From the measurement screen press LOG/CLEAR.
LCD displays "PLEASE WAIT". The LOG ### LOT ### screen displays on third LCD line the measurement log number (bottom left) and interval logging session lot number (bottom right).

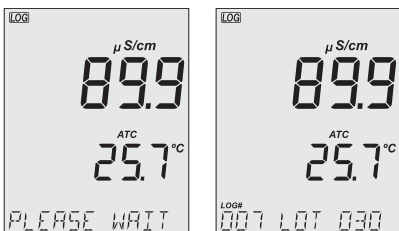

3. Press RANGE/▶ during logging to display the number of available records ("FREE" ###). Press RANGE/▶ again to return to return to active logging screen.

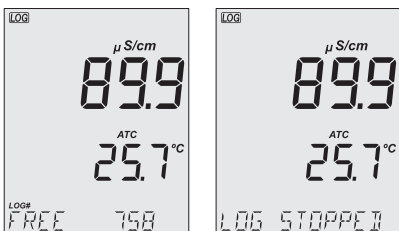

4. Press LOG/CLEAR again (or ESC) to end current interval logging session.
LCD displays "LOG STOPPED". Meter returns to measurement screen.

Interval Logging Warnings

"OUT OF SPEC"	Sensor failure is detected. Loggings stops.
"MAX LOTS"	Maximum number of lots reached (100). Cannot create new lots.
"LOG FULL"	Log space is full (1000 logs limit was reached). Loggings stops.

10.2. DATA MANAGEMENT

- A lot contains 1 to 600 log records (saved measurement data)
- Maximum number of lots that can be stored is 100, excluding Manual and Stability
- Maximum number of log records that can be stored is 1000, across all lots
- Manual and Stability logs can store up to 200 records (each)
- Interval logging sessions (across all 100 lots) can store up to 1000 records. When a logging session exceeds 600 records a new lot will be created.
- Lot name is given by a number, from 001 up to 999. Names are allocated incrementally, even after some lots have been deleted. Once lot name 999 was assigned, all lots have to be deleted, to reset lot naming to 001.

See Deleting Data section.

10.2.1. Viewing Data

1. Press RCL to access the logged data.
LCD displays "PLEASE WAIT" followed by "LOG RECALL" with ACCEPT tag blinking and the number of stored logs.

Note: Press RANGE/▶ to export all saved lots to external storage.

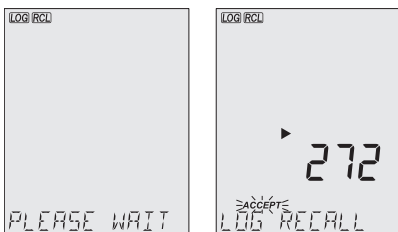

2. Press GLP/ACCEPT to confirm.
3. Use ▲▼ keys to select the lot type (MANUAL, STABILITY or interval ###).

Note: Press RANGE/▶ to export only the selected lot to external storage.

4. Press GLP/ACCEPT to confirm.
5. With a lot selected, use ▲▼ keys to view the records stored in that lot.

- Press RANGE/▶ to view, additional log data: date, time, cell factor, temperature coefficient, temperature reference, displayed on the third LCD line.

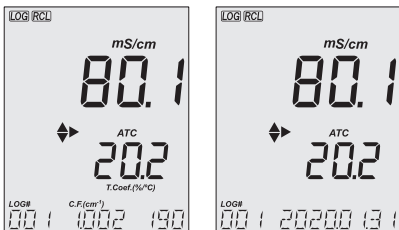

10.2.2. Deleting Data

Manual Log on Demand & Stability Log

- Press RCL to access the logged data.
LCD displays "PLEASE WAIT" followed by "LOG RECALL" with ACCEPT tag blinking and the number of stored logs.
- Press GLP/ACCEPT to confirm.
- Use ▲▼ keys to select MANUAL or STABILITY lot type.

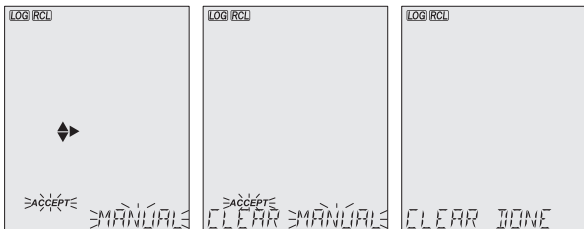

- With a lot selected, press LOG/CLEAR to delete entire lot.
"CLEAR" is displayed with ACCEPT tag and lot name blinking.
- Press GLP/ACCEPT to confirm (to exit, press ESC or CAL/EDIT or LOG/CLEAR). "PLEASE WAIT" with ACCEPT tag blinking is displayed, until the lot is deleted. After the selected lot has been deleted, "CLEAR DONE" displays briefly. Display shows "NO MANUAL / LOGS" or "NO STABILITY / LOGS".

Individual Logs / Records

1. Press RCL to access the logged data.
LCD displays "PLEASE WAIT" followed by "LOG RECALL" with ACCEPT tag blinking and the total number of logs.
2. Press GLP/ACCEPT to confirm.
3. Use ▲▼ keys to select MANUAL or STABILITY lot type.
4. Press GLP/ACCEPT to confirm.
5. Use the ▲▼ to navigate between logs. Log record number displays on the left.
6. With desired log record selected, press LOG/CLEAR to delete. "DELETE" is displayed with ACCEPT tag and log ### blinking.
7. Press GLP/ACCEPT to confirm (to exit, press ESC or CAL/EDIT or LOG/CLEAR). "DELETE" and Log ### blinking is displayed, until the log is deleted. After the log has been deleted "CLEAR DONE" message displays briefly.
Display shows logged data of the next log ###.

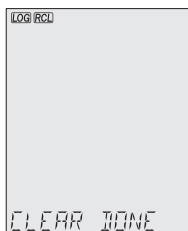
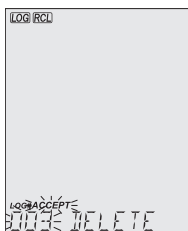

Note: Logs stored within an interval lot can not be deleted individually.

Log on Interval

1. Press RCL to access the logged data.
LCD displays "PLEASE WAIT" followed by "LOG RECALL" with ACCEPT tag blinking and the total number of logs.
2. Press GLP/ACCEPT to confirm.
3. Use ▲▼ keys to select an interval logging lot number.
The LOG ### LOT ### screen displays selected lot number (bottom right) and total logs stored in lot (bottom left).
4. Press GLP/ACCEPT to confirm (to exit, press ESC or CAL/EDIT or LOG/CLEAR).
5. With the lot selected, press LOG/CLEAR to delete entire lot. "CLEAR" is displayed with ACCEPT tag and lot name blinking.

Note: Use ▲▼ keys to select a different lot number.

- Press GLP/ACCEPT to confirm (to exit, press ESC or CAL/EDIT or LOG/CLEAR).

“PLEASE WAIT” with ACCEPT tag blinking is displayed, until the lot is deleted. After the lot has been deleted “CLEAR DONE” message displays briefly. Display shows the previous lot ###.

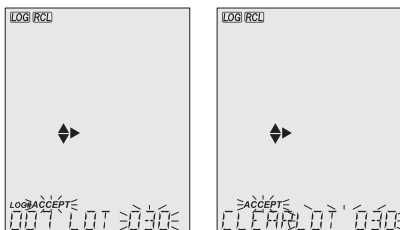

Delete All

- Press RCL to access the logged data.
LCD displays “PLEASE WAIT” followed by “LOG RECALL” with ACCEPT tag blinking and the number of stored logs.
- Press LOG/CLEAR to delete all logs.
“CLEAR ALL” is displayed with ACCEPT tag blinking.
- Press GLP/ACCEPT to confirm (to exit, press ESC or CAL/EDIT; or LOG/CLEAR).
“PLEASE WAIT” is displayed with a percentage counter, until all logs are deleted. After all logs have been deleted “CLEAR DONE” message displays briefly. Display returns to the log recall screen.

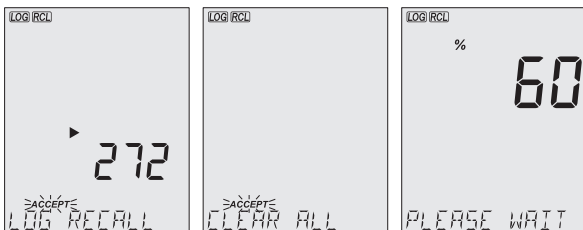

10.2.3. Exporting Data

PC Export

1. With the meter on, use the supplied micro USB cable to connect to a PC.
2. Press SETUP then CAL/EDIT.
3. Use the ▲▼ keys and select "EXPORT TO PC".
The meter is detected as a removable drive. LCD displays the PC icon.
4. Use a file manager to view or copy files on the meter.

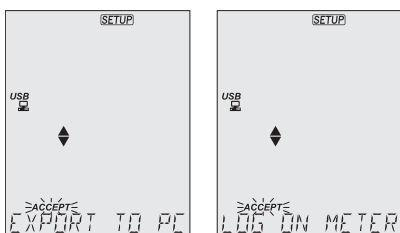

When connected to a PC, to enable logging:

- Press LOG/CLEAR. LCD displays "LOG ON METER" with ACCEPT tag blinking.
- Press GLP/ACCEPT. Meter disconnects from the PC and the PC icon is no longer displayed.
- To return to "EXPORT TO PC" mode, follow steps 2 and 3 above.

Exported data file details:

- The CSV file (comma separated values) may be opened with a text editor or spreadsheet application.
- The CSV file encoding is Western Europe (ISO-8859-1).
- Field separator may be set as comma or semicolon. See Separator Type in SETUP OPTIONS section.
- Interval log files are named ECLOT###, where ### is the lot number (e.g. ECLOT051).
- Manual log file is named ECLOTMAN and stability log file is named ECLOTSTAB.

USB Export All

1. With the meter on, insert a USB drive into the micro USB port located on top of the meter. If the flash drive does not have a micro USB connector, use an adapter.

2. Press RCL then RANGE/▶ to select the "EXPORT ALL" option.
3. Press GLP/ACCEPT to confirm.
LCD displays "EXPORTING" and the percentage counter, followed by "DONE" when export is completed. Display returns to the lot selection screen.

Note: The USB drive can be safely removed if the USB icon is not displayed. Do not remove the USB drive during export.

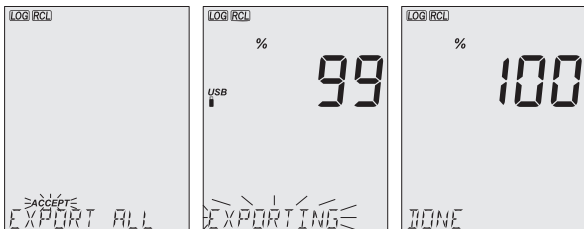

Overwriting existing data:

1. When the LCD displays "OVR" with LOT### blinking (USB icon is displayed), an identical named lot exists on the USB drive.
2. Press ▲ ▼ keys to select between YES, NO, YES ALL, NO ALL (ACCEPT tag blinking).
3. Press GLP/ACCEPT to confirm. Not confirming exits the export. Display returns to lot selection screen.

USB Export Selected

Logged data can be transferred separately by lots.

1. Press RCL to access the logged data.
LCD displays "PLEASE WAIT" followed by "LOG RECALL" with ACCEPT tag blinking and the number of stored logs.
2. Press GLP/ACCEPT to confirm.
3. Use ▲ ▼ keys to select the lot type (MANUAL, STABILITY or interval ###)
4. With the lot selected, press RANGE/▶ to export to USB drive.
LCD displays "PLEASE WAIT" followed by "EXPORTING" with ACCEPT tag and selected lot name (MAN / STAB / ###) blinking. LCD displays "EXPORTING" and the percentage counter, followed by "DONE" when export is completed. Display returns to the lot selection screen.

Note: The USB drive can be safely removed if the USB icon is not displayed. Do not remove the USB drive during export.

Overwriting existing data.

1. When the LCD displays "EXPORT" with ACCEPT and lot number blinking (USB icon displayed), an identical named lot exists on the USB drive.
2. Press GLP/ACCEPT to continue. LCD displays "OVERWRITE" with ACCEPT tag blinking.
3. Press GLP/ACCEPT (again) to confirm. Not confirming exits the export. Display returns to lot selection screen.

Data Management Warnings

"NO MANUAL / LOGS"	No manual records saved. Nothing to display.
"NO STABILITY / LOGS"	No stability records saved. Nothing to display.
"OVR" with lot ### (blinking)	Identically named lots on USB drive. Select overwrite option.
"NO MEMSTICK"	USB drive is not detected. Data can not be transferred. Insert or check the USB drive.
"BATTERY LOW" (blinking)	When low battery, export is not executed. Recharge the battery.

Logged Data Warnings in CSV file

°C !	Probe used beyond its operation specifications. Data not reliable.
°C !!	Meter in MTC mode.
°C !!!	Meter in NO TC mode. Temperature value only for reference.

11. GLP

Good Laboratory Practice (GLP) allows the user to store and recall calibration data. Correlating readings with specific calibrations ensures uniformity and consistency.

Calibration data is stored automatically after a successful calibration. A new EC calibration automatically clears the %NaCl calibration.

- Press RANGE/▶ to select between the measurement modes (EC/TDS or Salinity)
- Press GLP/ACCEPT and use the ▲ ▼ keys to scroll through the calibration data displayed on the third LCD line
- Press ESC or GLP/ACCEPT to return to measurement mode

GLP information is included with every data log.

11.1. EC/TDS INFORMATION

EC calibration data displayed on the third LCD line:

- Cell factor (in cm^{-1} is determined from the calibration with the current reading)
- Offset
- EC standard solution
- Temperature coefficient (T.Coef.)
- Temperature reference - user selected (T.Ref.)
- Time, date
- Calibration expiration time

11.2. %NaCl INFORMATION

Salinity calibration data displayed on the third LCD line:

- Cell factor
- Coefficient
- Salinity standard solution
- Time, date
- Calibration expiration time

12. TROUBLESHOOTING

Symptom	Problem	Solution
Slow response / Excessive drift	Dirty probe	Remove and clean the sleeve. Make sure the probe rings are clean.
Reading fluctuates up and down (noise)	Probe sleeve placed incorrectly. Air bubbles inside sleeve.	Correctly place the sleeve. Tap the probe to remove air bubbles.
Display shows EC, TDS or NaCl reading blinking	Reading is out of range	Recalibrate the meter. Sample not within measurable range. Disable autoranging feature.
Meter fails to calibrate or gives faulty readings	Broken probe	Replace the probe.
LCD tags displayed continuously at startup	ON/OFF key is blocked	Check the keyboard. If error persists, contact Milwaukee Technical Service.
"Internal Er X" message	Internal error	Restart the meter. If error persists, contact Milwaukee Technical Service.

13. ACCESSORIES

MA815D/1	4-ring EC / TDS / NaCl / Temperature probe with DIN connector
MA9060	12880 $\mu\text{S}/\text{cm}$ Calibration solution (230 ml)
MA9061	1413 $\mu\text{S}/\text{cm}$ Calibration solution (230 ml)
MA9063	84 $\mu\text{S}/\text{cm}$ Calibration solution (230 ml)
MA9064	80000 $\mu\text{S}/\text{cm}$ Calibration solution (230 ml)
MA9065	111.8 mS/cm Calibration solution (230 ml)
MA9066	NaCl 100% Calibration solution (230 ml)
MA9069	5000 $\mu\text{S}/\text{cm}$ Calibration solution (230 ml)

CERTIFICATION

Milwaukee Instruments conform to the CE European Directives.



Disposal of Electrical & Electronic Equipment. Do not treat this product as household waste. Hand it over to the appropriate collection point for the recycling of electrical and electronic equipment.

Disposal of waste batteries. This product contains batteries. Do not dispose of them with other household waste. Hand them over to the appropriate collection point for recycling.

Please note: proper product and battery disposal prevents potential negative consequences for human health and the environment. For detailed information, contact your local household waste disposal service or go to www.milwaukeeinstruments.com (US only) or www.milwaukeeinst.com.

RECOMMENDATION

Before using this product, make sure it is entirely suitable for your specific application and for the environment in which it is used. Any modification introduced by the user to the supplied equipment may compromise the meter's performance. For your and the meter's safety do not use or store the meter in hazardous environment. To avoid damage or burn, do not perform any measurement in microwave ovens.

WARRANTY

This instrument is warranted against defects in materials and manufacturing for a period of 2 years from the date of purchase. Electrodes and Probes are warranted for 6 months. This warranty is limited to repair or free of charge replacement if the instrument cannot be repaired. Damage due to accidents, misuse, tampering or lack of prescribed maintenance is not covered by warranty. If service is required, contact your local Milwaukee Instruments Technical Service. If the repair is not covered by the warranty, you will be notified of the charges incurred. When shipping any meter, make sure it is properly packaged for complete protection.

Milwaukee Instruments reserves the right to make improvements in design, construction and appearance of its products without advance notice.

THANK YOU FOR CHOOSING



Sales and Technical Service Contacts:

Milwaukee Electronics Kft.
Alsó-kikötő sor 11C
H-6726 Szeged - HUNGARY
tel: +36 62 428 050
fax: +36 62 428 051
www.milwaukeeinst.com
e-mail: sales@milwaukeeinst.com

Milwaukee Instruments, Inc.
2950 Business Park Drive
Rocky Mount, NC 27804 USA
tel: +1 (252) 443-3630
fax: +1 (252) 443-1937
www.milwaukeeinstruments.com
e-mail: sales@milwaukeeinstruments.com