

INSTRUCTION MANUAL

Milwaukee Wine Lab Minititrator

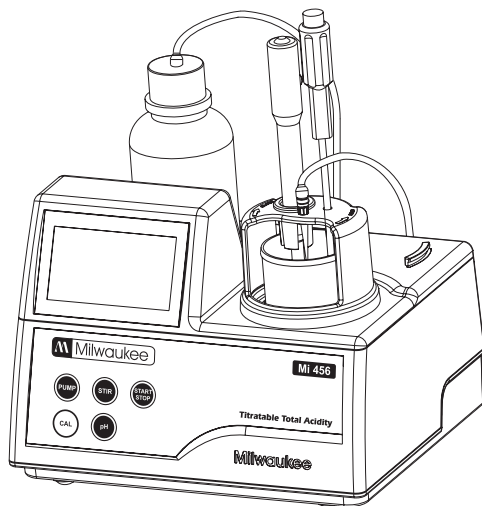

■ Mi456 Titratable Total Acidity



www.milwaukeeinst.com

TABLE OF CONTENTS

FUNCTIONAL DESCRIPTION	3
GENERAL DESCRIPTION	4
PRINCIPLE OF OPERATION	6
SPECIFICATIONS	7
STARTUP	8
GUIDE TO DISPLAY CODES	8
GENERAL TIPS FOR AN ACCURATE MEASUREMENT	11
PUMP CALIBRATION PROCEDURE	11
pH CALIBRATION PROCEDURE	13
MEASUREMENT PROCEDURE	14
PUMP TUBE REPLACEMENT	15
FUSE REPLACEMENT	16
ELECTRODE CONDITIONING AND MAINTENANCE	16
ACCESSORIES	18

FUNCTIONAL DESCRIPTION

FRONT PANEL

- A. TITRANT BOTTLE
- B. LIQUID CRYSTAL DISPLAY (LCD)
- C. KEYPAD
- D. ELECTRODE HOLDER

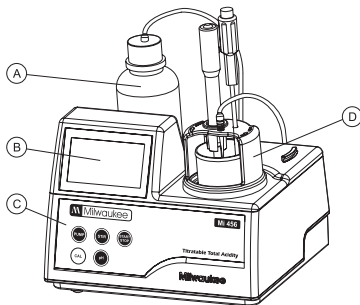

REAR PANEL

- E. pH ELECTRODE
- F. TEMPERATURE PROBE
- G. PERISTALTIC PUMP TUBE
- H. BEAKER
- I. PERISTALTIC PUMP
- J. TEMPERATURE PROBE CONNECTOR
- K. BNC ELECTRODE CONNECTOR
- L. FUSE
- M. POWER CABLE CONNECTOR
- N. POWER SWITCH

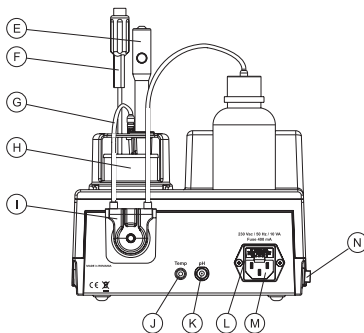

KEYPAD

- A. PUMP - to start/stop the pump
- B. CAL - to enter pump or pH calibration mode
- C. pH - to enter pH calibration mode (when CAL tag is active) to modify the end point value.
- D. STIR - to start/stop the stirrer while in measurement or purging mode
- E. START STOP - to start/stop titration

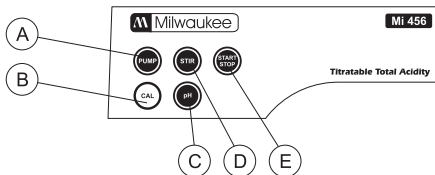

DISPLAY

- A. STABILITY INDICATOR: when reading is unstable or calibration is in progress
- B. STIRRER ACTIVE TAGS
- C. CALIBRATION MESSAGES
- D. PUMP ACTIVE TAGS
- E. CALIBRATION MESSAGES
- F. "pH" TAG: when a buffer is displayed on the secondary display
- G. FOUR DIGITS AND HALF SECONDARY DISPLAY
- H. "Time" TAG: when the time is displayed on the secondary display
- I. FOUR DIGITS AND HALF MAIN DISPLAY
- J. "pH" UPPER TAG: when the end point is modified
- K. AUTOMATIC TEMPERATURE COMPENSATION: when ATC blinks the temperature probe is not connected and the temperature is considered to be 25 °C

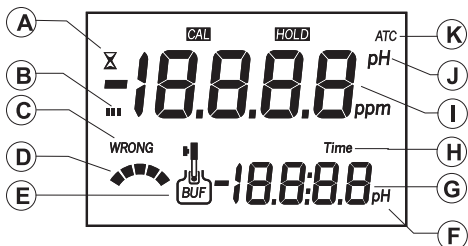

GENERAL DESCRIPTION

The **Mi456** is a low-cost, easy to use, microprocessor-based automatic titrator. It has a simple and reliable peristaltic pump that ensure high dosing repeatability. By performing pump calibration with the provided Milwaukee standards, the instrument accuracy is assured. The instrument comes with a preprogrammed analysis method designed for Total Titratable Acidity measurements on wine.

The **Mi456** performs automatic analysis, all the necessary calculations and assures to the user a simple and effective interface.

The instrument has a powerful and effective built-in algorithm to analyze the shape of the pH electrode response and to determine the reaction completion.

By simply pressing the START STOP button, the instrument will automatically make the titration up to the end point. The result is immediately displayed in convenient units, then the instrument is ready for another titration.

SIGNIFICANCE OF USE

Acids occur naturally during the growing of grapes and as part of the fermentation process. Wines show lower levels of acid when there are hot growing seasons or when the grapes come from hotter regions. In the proper proportion, acids are a desirable trait and give the wine character.

The three predominant acids in wine are tartaric, malic and citric, all of which are intrinsic to the grape. Tartaric acid is the principal acid in grapes and is a component that promotes a crisp flavor and graceful aging in wine. A moderate amount of a wine's acid comes from malic acid, which contributes to fruitiness, and a small amount comes from citric acid. Wine also contains trace amounts of other acids. The least desirable acid in wine is acetic acid, which, when present in more than a nominal amount, gives wine a sour or vinegary aspect. Total acidity, also called titratable acidity, is the sum of the fixed and volatile acids. In the United States the total acidity is usually expressed in terms of tartaric acid, even though the other acids are measured.

Total Acidity directly effects the color and flavor of wine and, depending on the style of the wine, is sought in a perfect balance with the sweet and bitter sensations of other components. Too much acidity makes wine tart and sharp; too little makes wines flat, flabby and uninteresting. Proper acidity in wine is what makes it refreshing and an ideal accompaniment to food.

The proper acid level of a wine varies, with sweeter wines generally requiring somewhat higher levels to retain the proper balance. For dry table wine the acceptable range is usually 0.60 to 0.75%; for sweet wine it's 0.70 to 0.85%.

This meter is supplied with:

- Reagents set for 20 titrations
- One 2000 μL automatic pipette
- Two plastic tips for the 2000 μL automatic pipette
- Two 50 mL beakers
- Tubes set with cap
- pH electrode
- Temperature probe
- Stir bar
- Power cable
- One 230 mL bottle of Refill Solution
- One 1 mL syringe
- Instruction manual

Note: Save all packing material until you are sure that the instrument works correctly. Any defective item must be returned in its original packing.

PRINCIPLE OF OPERATION

The determination of total acids in wine is made according to a neutralization reaction, that is the reaction between the acids found in wine and a base. This type of reaction forms the basis of titration methods of analysing acids.

Titrateable acidity is measured on a degassed sample at the end-point of 8.20 for Australian requirements and 7.00 to fulfil the requirements of the European Union. Both results are expressed as g/L tartaric acid.

For precise results it is very important to know the exact sample volume, titrant volume and concentration.

The peristaltic pump has a good repeatability but the dosing volume depends on many factors as the diameter of the tube or the tube stretching. To compensate for all this errors, the pump need to be calibrated. The calibration of the pump is also needed in order to have high precision of the titrations. It is important to calibrate the pump at the pH value you want to use as the endpoint of the titrations.

The calibration procedure is in fact the analysis of a known solution. By doing this, the instrument makes a differential analysis between the standard and the wine sample. The pump volumetric debit and the real concentration of the titrant is compensated. Only the sample volume has to be precisely known.

SPECIFICATIONS

Range	0.0 to 25.0 g/L of tartaric acid
Resolution	0.1 g/L
Accuracy	5% of reading
Method	Acid-base titration method
Principle	End-point titration
pH Calibration	One-point in selected end-point: 7.00 pH or 8.20 pH
Sample volume	2 mL
Temperature Compensation	Automatic from 0.0 to 100.0 °C
pH Electrode	MA919B/1 (included)
Temperature Probe	MA831R (included)
Pump debit	0.5 mL/min
Stirring speed	1500 rpm
Environment	0 to 50 °C (32 to 122 °F) ; max 95% RH non-condensing
Power supply	220V/50Hz; 10VA
Dimensions	208 x 214 x 163 mm (8.2 x 8.4 x 6.4") (with beaker)
Weight	2200 g (77,6 oz.).

Required Reagents

<u>Code</u>	<u>Description</u>	<u>Quantity/test</u>
Mi556-001	Standard	2 mL
Mi556-002	Titrant	
Mi556-003	Buffer pH 7.00	50 mL
Mi556-004	Buffer pH 8.20	50 mL

This instrument is in compliance with CE Directives.

STARTUP

- Place the instrument on a flat table. Do not place the instrument on direct sun light.
- Connect the titrator to mains socket with ground connection and the correct voltage and frequency. See the label on the instrument rear for this.
- Place the peristaltic pump tube on the pump. See the Pump Tube Replacement section for the procedure.
- Remove the reagent bottle cap and place the bottle cap of the tubes set. Place the reagent bottle in the appropriate place on the titrator top.
- Connect the tubes with the peristaltic pump (inlet tube is connected with the reagent bottle, outlet tube is connected with the dosing tip).
- Turn the instrument ON using the power switch from the rear panel of the instrument and wait until it displays dashes.

GUIDE TO DISPLAY CODES

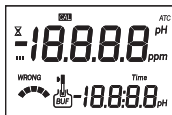

This screen appears for a few seconds each time the instrument is turned ON.

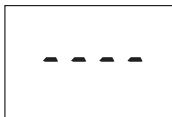

Main screen display.

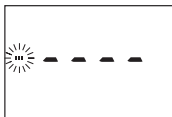

Main screen display with stirrer active.



Purging mode message.

PUMP CALIBRATION MESSAGES

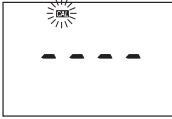

This screen appears each time the meter enters pump or pH calibration mode by pressing the CAL button. The meter is ready to start pump calibration by pressing the PUMP button. The meter returns to the main screen by pressing the CAL button.

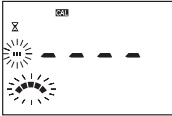

This screen appears while pump calibration is in progress. Pressing CAL or PUMP button, the titrator returns to the main screen.



This screen appears for a few seconds before returning to the main screen, when pump calibration is done.



This error message appears when the sample concentration exceeds 400 ppm.

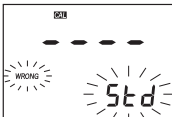

The used standard solution is wrong.

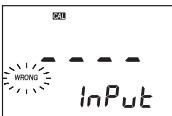

This error message appears when the input readings (mV) exceed the input limits (0÷1000mV).

pH CALIBRATION MESSAGES

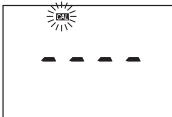

This screen appears each time the meter enters pump or pH calibration mode by pressing the CAL button.

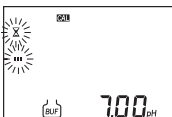

This screen appears when the pH calibration is started by pressing the pH button. Pressing again pH or the CAL button, the pH calibration is aborted and the instrument returns to the main screen.



This prompt appears for a few seconds before returning to the main screen, when the pH calibration is done.

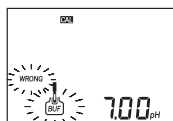

The "WRONG" "⚡" / "WRONG" "☹️" tags alternatively blinking appear when the buffer solution is not correct or when the probe is wrong. Clean the electrode by following the Cleaning Procedure or check the quality of the buffer in order to continue the pH calibration.

Press the CAL or pH button to leave pH calibration mode.

pH END POINT SETUP MESSAGES

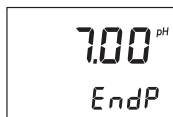

This screen appears when the meter is in main screen and the pH button is pressed. Press the CAL button in order to change the end-point. Each time the pH button is pressed the end point value is changed and the meter returns to the main screen.

TITRATION MESSAGES

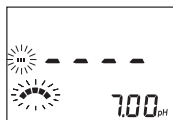

This screen appears each time the minititrator enters TITRATION mode. Press the START STOP button in order to stop the titration and return to the main screen.

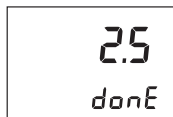

The titration result, expressed as concentration of tartaric acid in g/L, is displayed at the end of the titration process. Press the START STOP button to return to the main screen.



This error message appears when the input reading (pH, temperature) exceeds the input limits.



This screen appears when the evaluated concentration is out of range.

GENERAL TIPS FOR AN ACCURATE MEASUREMENT

The instructions listed below should be carefully followed during testing to ensure best accuracy.

- Purge the peristaltic pump to have fresh titrant when starting a new analysis or calibration.
- Calibrate the peristaltic pump before performing an analysis.
- Analyze the wine immediately after the sample is obtained.

PUMP CALIBRATION PROCEDURE

Warning: The calibration of the pump must be performed each time the pump tube, the reagent bottle or the pH electrode is changed. It is recommended to perform the pump calibration before each set of measurements.

- Use the 2000 μL automatic pipette to add exactly 2 mL of **Mi556-001** Standard to the 50 mL beaker.
- Fill the beaker up to the 50 mL mark with deionized water, place the stirrer bar into the beaker and then place the beaker in the appropriate place on the minititrator top.
- Place the electrode holder on the top of the beaker and secure by turning clockwise.

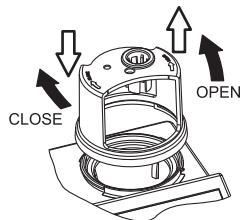
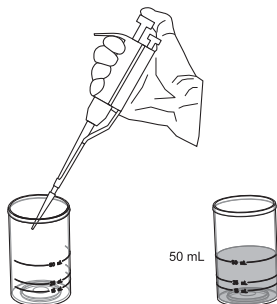

- Immerse the pH and the temperature probe approximately 2 cm (0.8") into the sample to be tested while paying attention to not touch the stir bar.
- Insert the dosing tip in the appropriate holder place and pay attention to not be immersed into solution.
- After sample preparation, press the **CAL** button to enter the pump calibration mode. The CAL tag will start blinking.
- Press **PUMP** in order to start the pump calibration.
- At the end of the calibration, "done" appears for a few seconds and the meter returns to the measurement mode.

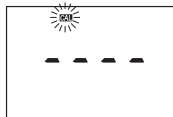
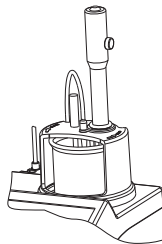

pH CALIBRATION PROCEDURE

The pH calibration must be performed each time the pH electrode is changed.

- Turn the instrument ON using the power switch from the rear panel of the instrument.
- Fill the 50 mL beaker up to the 50 mL mark with Buffer Solution 1 (7.00 pH) or Buffer Solution 2 (8.20 pH).
- Place the pH electrode into solution and press the **CAL** button. The **CAL** tag will appear blinking.
- Press **pH** in order to start the electrode calibration.
- At the end of the calibration procedure “done” appears for a few seconds and then the meter automatically returns to measurement mode.

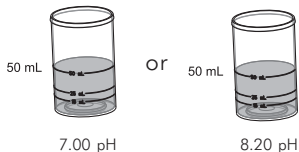

MEASUREMENT PROCEDURE

Warning: Make sure the instrument has been calibrated (pH and pump calibration) before performing a wine sample analysis.

- Use the 2000 μL automatic pipette to add exactly 2 mL of wine sample to the 50 mL beaker.
- Fill the beaker up to the 50 mL mark with deionized water, place the stirrer bar into the beaker and then place the beaker in the appropriate place on the minitrator top.

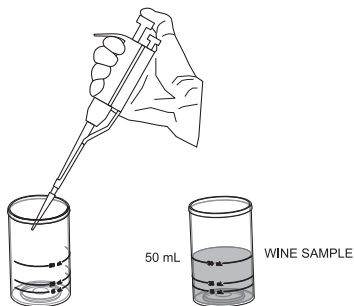

- Place the electrode holder on the top of the beaker and secure it by turning clockwise.

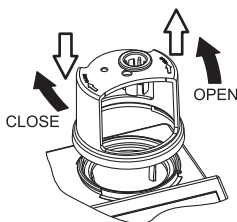

- Immerse the pH and the temperature probe approximately 2 cm (0.8") into the sample to be tested while paying attention to not touch the stir bar.
- Insert the dosing tip in the appropriate holder place and pay attention to not be immersed into solution.

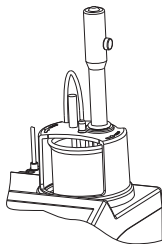

- Press the **START STOP** button to start the titration. The display will show “----” during titration, along with stirrer and pump tags blinking on the LCD, and 7.00 or 8.20 pH buffer on the secondary display.
- At the end of the titration, the Total Titratable Acidity concentration is displayed in g/L.



Note: If the end-point is not reached or it is not recognized because of the noisy solution, an error message will be displayed.

PUMP TUBE REPLACEMENT

To remove the tube of the peristaltic pump follow next steps:

- Detach the old tube system from the reagent bottle.
- Grasp one fixing ring of the peristaltic pump tube.
- Pull the tube until it's taken out from its location.
- Remove the other side of the tube.

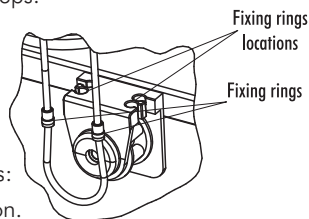

To mount the new peristaltic pump tube follow next steps:

- Position one peristaltic pump fixing ring on its location.
- Stretch the tube over the peristaltic pump cylinders.
- Fix the second pump fixing ring on its location.
- Attach the tube to the reagent bottle.

Note: Purge the peristaltic pump until drops of reagent appears on the dosing tip by pressing the **PUMP** button.

FUSE REPLACEMENT

To change the fuse follow next steps:

- Disconnect the power cord from the rear panel of the instrument.
- Pull out the fuse holder located near the power cord connector.
- Replace the fuse with a similar one.
- Push the fuse holder with the fuse in the appropriate place.

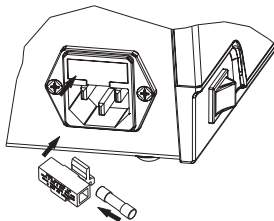

ELECTRODE CONDITIONING & MAINTENANCE

PREPARATION PROCEDURE

Remove the protective cap of the pH electrode (**MA919B/1**).

DO NOT BE ALARMED IF SALT DEPOSITS ARE PRESENT. This is normal with electrodes. They will disappear when rinsed with water.

During transport, tiny bubbles of air may form inside the glass bulb affecting proper functioning of the electrode. These bubbles can be removed by “shaking down” the electrode as you would do with a glass thermometer.

If the bulb and/or junction is dry, soak the electrode in **MA9015** Storage Solution for at least one hour.

If the filling solution (electrolyte) is more than 2½ cm (1”) below the fill hole, add

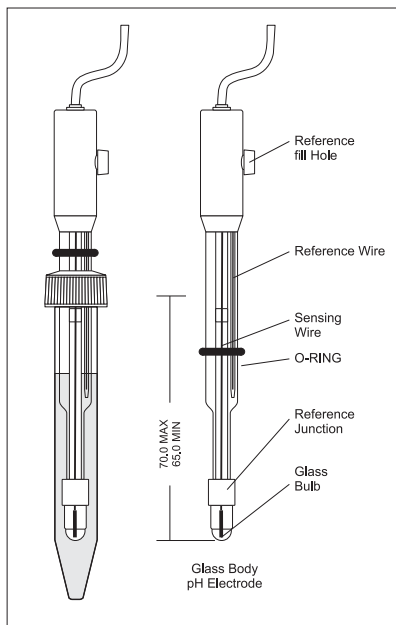

MA9011 3.5M KCl Electrolyte Solution. For faster response, unscrew the fill hole screw during measurements.

STORAGE PROCEDURE

To minimize clogging and assure a quick response time, the glass bulb and the junction of the electrode should be kept moist and not allowed to dry out.

Replace the solution in the protective cap with a few drops of **MA9015** Storage Solution or, in its absence, Filling Solution (**MA9011**). Follow the Preparation Procedure before taking measurements.

Note: NEVER STORE THE ELECTRODE IN DISTILLED OR DEIONIZED WATER.

PERIODIC MAINTENANCE

Inspect the electrode and the cable. The cable used for connection to the instrument must be intact and there must be no points of broken insulation on the cable or cracks on the electrode stem or bulb. Connectors must be perfectly clean and dry. If any scratches or cracks are present, replace the electrode. Rinse off any salt deposits with water.

Probe Maintenance

Refill the reference chamber with fresh electrolyte (**MA9011**). Allow the electrode to stand upright for 1 hour. Follow the Storage Procedure above.

CLEANING PROCEDURE

- *Wine deposits* Soak in Milwaukee **MA9016** cleaning solution for 1 hour
- *Wine stains* Soak in Milwaukee **MA9016** cleaning solution for 1 hour

IMPORTANT: After performing any of the cleaning procedures, rinse the electrode thoroughly with distilled water, refill the reference chamber with fresh electrolyte and soak the electrode in **MA9015** Storage Solution for at least 1 hour before taking measurements.

ACCESSORIES

REAGENT SETS

MA9015	Electrode storage solution (220 mL)
MA9016	Cleaning solution (220 mL)
MA9011	Electrode filling solution (230 mL)
Mi456KIT	Reagent set
Mi556-001	Calibration standard (100 mL)
Mi556-002	Titration solution (100 mL)
Mi556-003	Buffer solution 1 pH 7.00 (100 mL)
Mi556-004	Buffer solution 2 pH 8.20 (100 mL)

OTHER ACCESSORIES

MA919B/1	pH electrode with 1 m cable
MA831R	Temperature probe
	Tube set with cap for titration bottle and tip
Mi0022	2000 μ L pipette
Mi0023	Pipette tips for 2000 μ L pipette (4 pcs.)
Mi0009	Stir bar (5 pcs.)
Mi0020	Beaker 50 mL (4 pcs.)
	Power cable

Recommendations for Users

Before using this product, make sure that it is entirely suitable for your specific application and for the environment in which it is used.

Operation of this instrument may cause unacceptable interferences to other electronic equipments, this requiring the operator to take all necessary steps to correct interferences.

Any variation introduced by the user to the supplied equipment may degrade the instrument EMC performance.

To avoid damages or burns, do not put the instrument in microwave ovens. For yours and the instrument safety do not use or store the instrument in hazardous environments.

For your Safety don't use or store the instrument in hazardous environments. To avoid damages or burns, do not perform any measurement in microwave ovens.

WARRANTY

This instrument is warranted against defects in materials and manufacturing for a period of 2 years from the date of purchase. Electrodes are warranted for 6 months.

If during this period the repair or replacement of parts is required, where the damage is not due to negligence or erroneous operation by the user, please return the instrument, electrode and probe to either distributor or our office and the repair will be effected free of charge.

Damage due to accidents, misuse, tampering or lack of prescribed maintenance is not covered by the warranty.

Milwaukee/Martini instruments reserves the right to make improvements in design, construction and appearance of its products without advance notice.

THANK YOU FOR CHOOSING



Sales and Technical Service Contacts:

Milwaukee Electronics Kft.

Alsóikötő sor 11.

6726, Szeged, Hungary

Tel: +36-62-428-050

Fax: +36-62-428-051

e-mail: sales@milwaukeeinst.com

Milwaukee Instruments, Inc.

2950 Business Park Drive Rocky Mount, NC

27804 USA

Tel: +1 252 443 3630

Fax: +1 252 443 1937

e-mail: sales@milwaukeetesters.com

www.milwaukeeinst.com