

INSTRUCTION MANUAL

Milwaukee Refractometer



■ MA886

Refractometer for Sodium Chloride Measurements

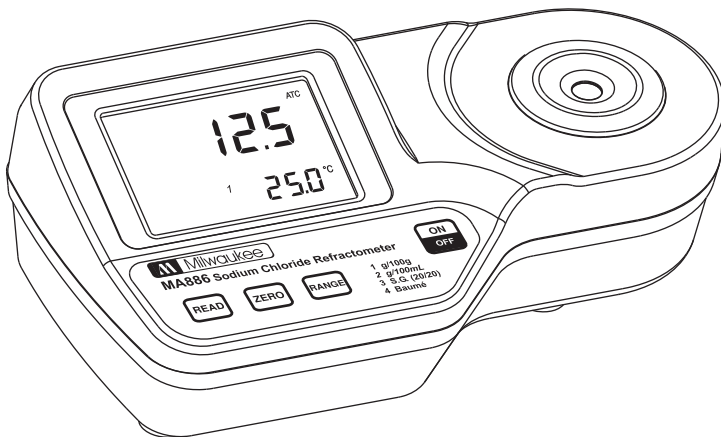

www.milwaukeeinst.com

TABLE OF CONTENTS

FUNCTIONAL DESCRIPTION	3
GENERAL DESCRIPTION	5
SPECIFICATIONS	6
PRINCIPLE OF OPERATION	6
MEASUREMENT GUIDELINES	8
CALIBRATION PROCEDURE	8
MEASUREMENT PROCEDURE	10
CHANGING MEASUREMENT UNIT	11
CHANGING TEMPERATURE UNIT	12
MAKING A STANDARD SODIUM CHLORIDE SOLUTION	12
ERROR MESSAGES	13
BATTERY REPLACEMENT	14
WARRANTY	15

Remove the instrument from the packing materials and examine carefully to ensure no damage has occurred during shipping. If any damage has occurred, notify your Dealer.

Each instrument is supplied with:

- 9 V battery
- Instruction manual

Note: Save all packing material until you are sure that the instrument functions correctly. A defective instrument must be returned in its original packing.

FUNCTIONAL DESCRIPTION

DISPLAY

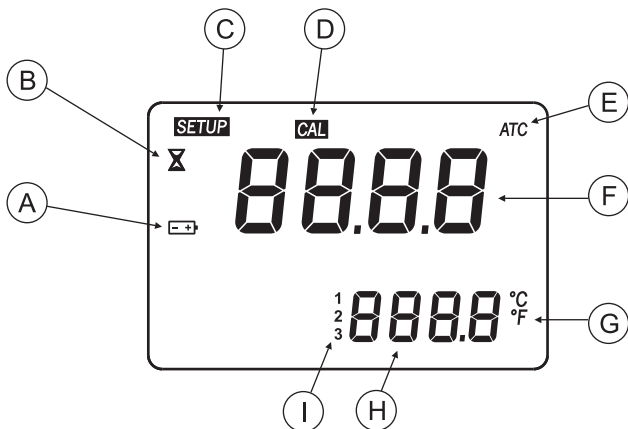

- A. BATTERY STATUS ICON (BLINKS WHEN LOW BATTERY CONDITION DETECTED)
- B. MEASUREMENT IN PROGRESS TAG
- C. SETUP: FACTORY CALIBRATION TAG
- D. CAL: CALIBRATION TAG
- E. AUTOMATIC TEMPERATURE COMPENSATION
(BLINKS WHEN TEMPERATURE EXCEEDS 10-40 °C / 50-104 °F RANGE)
- F. PRIMARY DISPLAY (DISPLAYS MEASUREMENT AND ERROR MESSAGES)
- G. TEMPERATURE UNITS
- H. SECONDARY DISPLAY (DISPLAYS TEMPERATURE MEASUREMENTS; WHEN BLINKING, TEMPERATURE HAS EXCEEDED OPERATION RANGE: 0-80 °C / 32-176 °F)
- I. RANGE INDICATOR

FRONT PANEL

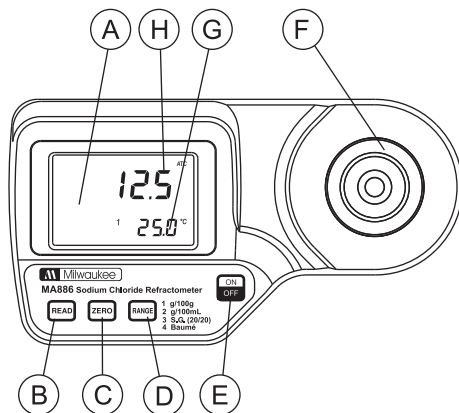

- A. LIQUID CRYSTAL DISPLAY (LCD)
- B. READ KEY (USER MEASUREMENT)
- C. ZERO KEY (USER CALIBRATION)
- D. RANGE KEY (USER MEASUREMENT UNIT)
- E. ON/OFF
- F. STAINLESS STEEL SAMPLE WELL AND PRISM
- G. SECONDARY DISPLAY
- H. PRIMARY DISPLAY

BOTTOM

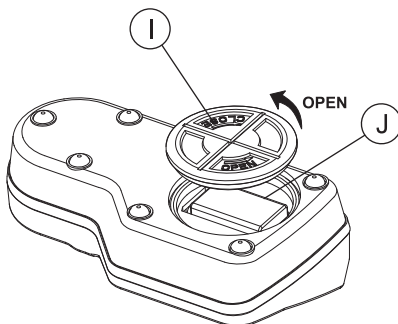

- I. BATTERY COVER
- J. BATTERY COMPARTMENT

GENERAL DESCRIPTION

SIGNIFICANCE OF USE

Thank you for choosing Milwaukee. This instruction manual will provide you the necessary information for correct use of the meter.

The **MA886** is an optical instrument that employs the measurement of the refractive index to determine sodium chloride concentration in aqueous solutions used in food preparation. It is not intended for sea water salinity measurements. The measurement of refractive index is simple and quick and provides the user an accepted method for NaCl analysis. Samples are measured after a simple user calibration with deionized or distilled water. Within seconds the instrument measures the refractive index of the solution. The digital refractometer eliminates the uncertainty associated with mechanical refractometers and is easily portable for measurements where you need them.

The instrument utilizes internationally recognized references for unit conversion and temperature compensation. It can display the measurement of NaCl concentration 4 different ways: g/100 g, g/100 mL, Specific Gravity, and °Baumé.

Temperature (in °C or °F) is displayed simultaneously with the measurement (on 3 of the ranges) on the large dual level display along with icons for Low Power and other helpful message codes.

Key features include:

- Waterproof models offers IP65 waterproof protection
- Automatic Temperature Compensation (ATC)
- Battery operation with Low Power indicator
- Automatically turns off after 3 minutes of non-use.

SPECIFICATIONS

	g/100 g	g/100 mL	Specific Gravity	°Baumé	°C (°F)
Range:	0 to 28	0 to 34	1.000 to 1.216	0 to 26	0 to 80 °C (32 to 176 °F)
Resolution:	0.1	0.1	0.001	0.1	0.1 °C (0.1 °F)
Accuracy:	±0.2	±0.2	±0.002	±0.2	±0.3 °C (±0.5 °F)

Light Source	Yellow LED
Measurement Time	Approximately 1.5 seconds
Minimum Sample Volume	100 µL (cover prism totally)
Sample Cell	Stainless Steel ring and flint glass prism
Temperature Compensation	Automatic between 10 and 40 °C (50 to 104 °F)
Case Material	ABS
Enclosure Rating	IP 65
Battery Type/Life	1 x 9 volt AA batteries / 5000 readings
Auto-Shut off	After 3 minutes of non-use
Dimensions	19.2 x 10.2 x 6.7 cm (7.5 x 4 x 2.6")
Weight	420 g (14.8 oz.).

PRINCIPLE OF OPERATION

Aqueous NaCl determinations are made by measuring the refractive index of a solution. Refractive Index is an optical characteristic of a substance and the number of dissolved particles in it. Refractive Index is defined as the ratio of the speed of light in empty space to the speed of light in the substance. A result of this property is that light will “bend”, or change direction, when it travels through a substance of different refractive index. This is called refraction.

When passing from a material with a higher to lower refractive index, there is a critical angle at which an incoming beam of light can no longer refract, but will instead be reflected off the interface. The critical angle can be used to easily calculate the refractive index according to the equation:

$$\sin(\theta_{\text{critical}}) = n_2 / n_1$$

Where n_2 is the refractive index of the lower-density medium; n_1 is the refractive index of the higher-density medium.

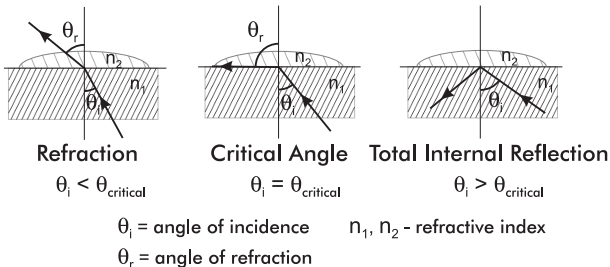

In the **MA886** refractometer, light from an LED passes through a prism in contact with the sample. An image sensor determines the critical angle at which the light is no longer refracted through the sample.

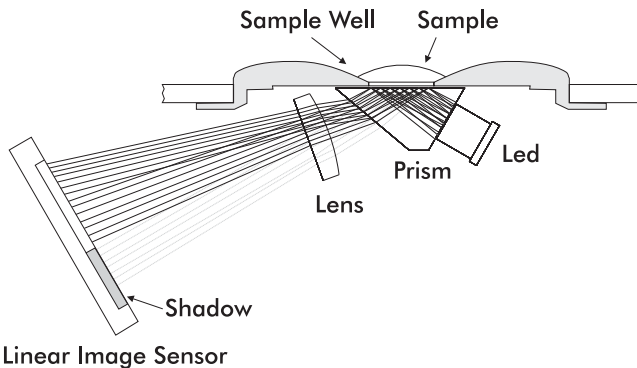

Specialized algorithms then apply temperature compensation to the measurement and convert this refractive index to: g/100 g (% by mass), g/100 mL, Specific Gravity (S.G. 20/20), or Baumé.

MEASUREMENT GUIDELINES

- Handle instrument carefully. Do not drop.
- Do not immerse instrument under water.
- Do not spray water to any part of instrument except the “sample well” located over the prism.
- The instrument is intended to measure sodium chloride solutions. Do not expose instrument or prism to solvents that will damage it. This includes most organic solvents and extremely hot or cold solutions.
- Particulate matter in a sample may scratch the prism. Absorb sample with a soft tissue and rinse sample well with deionized or distilled water between samples.
- Use plastic pipettes to transfer all solutions. Do not use metallic tools such as needles, spoons or tweezers as these will scratch the prism.
- Cover sample well with hand if measuring in direct sun.

CALIBRATION PROCEDURE

Calibration should be performed daily, before measurements are made, when the battery has been replaced, between a long series of measurements, or if environmental changes have occurred since the last calibration..

1. Press the **ON/OFF** key, then release. Two instrument test screens will be displayed briefly; all LCD segments followed by the percentage of remaining battery life. It will briefly display an indication of the measurement units set. When the LCD displays dashes, the instrument is ready.



- Using a plastic pipette, fill the sample well with distilled or deionized water. Make sure the prism is completely covered.



Note: If the ZERO sample is subject to intense light such as sunlight or another strong source, cover the sample well with your hand or other shade during the calibration.

- Press the **ZERO** key. If no error messages appear, your unit is calibrated.

(For a description of ERROR MESSAGES see page 13).

Note: The 0.0 screen will remain until a sample is measured or the power is turned off.



- Gently absorb the ZERO water standard with a soft tissue. Use care not to scratch the prism surface. Dry the surface completely. The instrument is ready for sample measurement.



Note: If instrument is turned off the calibration will not be lost.

MEASUREMENT PROCEDURE

Verify the instrument has been calibrated before taking measurements.

1. Wipe off prism surface located at the bottom of the sample well. Make sure the prism and sample well are completely dry.



2. Using a plastic pipette, drip sample onto the prism surface. Fill the well completely.



Note: If the temperature of the sample differs significantly from the temperature of the instrument, wait approximately 1 minute to allow thermal equilibration.

3. Press the **READ** key. The results are displayed in unit of interest.

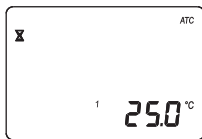

Note: The last measurement value will be displayed until the next sample is measured or the instrument is turned off. Temperature will be continuously updated.

Note: The "ATC" tag blinks and automatic temperature compensation is disabled if the temperature exceeds the 10-40 °C / 50-104 °F range.

Note: Temperature is not displayed in Baumé mode.

4. Remove sample from the sample well by absorbing on a soft tissue.

5. Using a plastic pipette, rinse prism and sample well with distilled or deionized water. Wipe dry. The instrument is ready for the next sample.

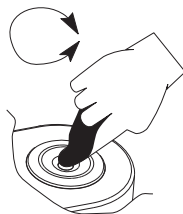

CHANGING MEASUREMENT UNIT

Press the **RANGE** key to select measurement units. The instrument toggles between the four measurement scales each time the key is pressed and the primary display indicates “**G-G**” for g/100 g, “**G-L**” for g/100 mL, “**S.G.**” for Specific Gravity and “**bAU**” for Baumé. When the instrument displays the screen with 4 dashes, the instrument is ready for measurement. A number on the display indicates the selected unit: “**1**” denotes g/100 g, “**2**” denotes g/100 mL, “**3**” denotes Specific Gravity and “**4**” in the secondary display denotes Baumé (as indicated on the instrument cover).

Note: Temperature is not displayed in Baumé mode.

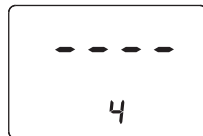
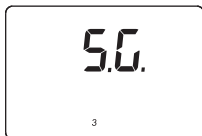
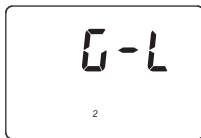
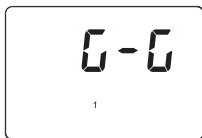

CHANGING TEMPERATURE UNIT

To change the temperature measurement unit from Celsius to Fahrenheit (or vice versa), follow this procedure.

1. Press and hold the **ON/OFF** key continuously for approximately 8 seconds. The LCD will display the "all segment" screen followed by a screen with the model number on the primary display and the version number on the secondary display. Continue pressing the **ON/OFF** key.



8 seconds

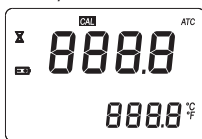

2. While continuing to hold the **ON/OFF** key, press the **ZERO** key. The temperature unit will change from °C to °F or vice versa.



°C or °F

MAKING A STANDARD SODIUM CHLORIDE SOLUTION

To make a Standard NaCl Solution follow the procedure below:

- Place container (such as a glass vial or dropper bottle that has a cover) on an analytical balance.
- Tare the balance.
- To make an X NaCl solution weigh out X grams of high purity dried Sodium Chloride (CAS #: 7647-14-5) directly into the container.
- Add distilled or deionized water to the container so the total weight of the solution is 100 g.

Example with g/100 g NaCl:

g/100 g NaCl

10

g NaCl

10.000















g Water

90.000

g Total

100.000

ERROR MESSAGES

Error Code	Description
Err	 <p>General failure. Cycle power to instrument. If instrument still has error, contact Milwaukee.</p>
LO Primary display	 <p>Sample is reading lower than the 0% standard used for meter calibration.</p>
HI Primary display	 <p>Sample exceeds maximum measurement range.</p>
LO Primary display Cal segment ON	 <p>Wrong calibration used to zero instrument. Use deionized or distilled water. Press Zero.</p>
HI Primary display Cal segment ON	 <p>Wrong calibration used to zero instrument. Use deionized or distilled water. Press Zero.</p>
† LO Primary display Cal segment ON	 <p>Temperature exceeds ATC low limit (10 °C) during calibration.</p>
† HI Primary display Cal segment ON	 <p>Temperature exceeds ATC high limit (40 °C) during calibration.</p>
Air	 <p>Prism surface insufficiently covered.</p>
Elt	 <p>Too much external light for measurement. Cover sample well with hand.</p>
nLt	 <p>LED light is not detected. Contact Milwaukee.</p>
Battery segment blinking	 <p>< 5% of battery life is remaining.</p>
Temperature values are blinking 0.0° or 80.0°C	 <p>Temperature measurement out of sampling range (0.0 to 80.0°C).</p>
ATC segment blinking	 <p>Outside temperature compensation range (10 to 40°C).</p>
SETUP segment blinking	 <p>Factory calibration lost. Contact Milwaukee.</p>

BATTERY REPLACEMENT

To replace the instrument's battery, follow these steps:

- Turn the instrument OFF by pressing the **ON/OFF** key.



- Turn instrument upside down and remove the battery cover by turning it counterclockwise.

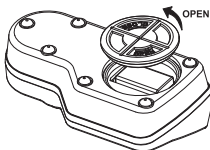

- Extract the battery from its location.
- Replace with fresh 9V battery making certain to observe polarity.
- Insert the back battery cover and fasten it by turning clockwise to engage.

For your Safety don't use or store the instrument in hazardous environments. To avoid damages or burns, do not perform any measurement in microwave ovens.

WARRANTY

This instrument is warranted against defects in materials and manufacturing for a period of 2 years from the date of purchase. Electrodes are warranted for 6 months.

If during this period the repair or replacement of parts is required, where the damage is not due to negligence or erroneous operation by the user, please return the instrument, electrode and probe to either distributor or our office and the repair will be effected free of charge.

Damage due to accidents, misuse, tampering or lack of prescribed maintenance is not covered by the warranty.

Milwaukee/Martini instruments reserves the right to make improvements in design, construction and appearance of its products without advance notice.

THANK YOU FOR CHOOSING



Sales and Technical Service Contacts:

Milwaukee Electronics Kft.

Alsóikötő sor 11.

6726, Szeged, Hungary

Tel: +36-62-428-050

Fax: +36-62-428-051

e-mail: sales@milwaukeeinst.com

Milwaukee Instruments, Inc.

2950 Business Park Drive Rocky Mount, NC

27804 USA

Tel: +1 252 443 3630

Fax: +1 252 443 1937

e-mail: sales@milwaukeetesters.com

www.milwaukeeinst.com