



SP-710B Water Multimeter Operation Manual



Jan. 23, 2019

Rev. A

US Patent: 9612221

Pyxis Lab, Inc.

1729 Majestic Dr. Suite 5

Lafayette, CO 80026 USA

www.pyxis-lab.com

© 2017 Pyxis Lab, Inc.

Pyxis Lab Proprietary and Confidential

The information contained in this manual may be confidential and proprietary and is the property of Pyxis Lab, Inc. Information disclosed herein shall not be used to manufacture, construct, or otherwise reproduce the goods described. Information disclosed herein shall not be disclosed to others or made public in any manner without the express written consent of Pyxis Lab, Inc.

Limited Warranty

Pyxis Lab warrants its products for defects in materials and workmanship. Pyxis Lab will, at its option, repair or replace instrument components that prove to be defective with new or remanufactured components (i.e., equivalent to new). The warranty set forth is exclusive and no other warranty, whether written or oral, is expressed or implied.

Device Warranty Term

The Pyxis warranty for SP-710 and SP-710B 'device not including pH-ORP module' term is thirteen (13) months from original shipment from Pyxis. In no event shall the standard limited warranty coverage extend beyond thirteen (13) months from original shipment date.

pH/ORP Module Warranty Term

The Pyxis warranty term for the pH/ORP module is six (6) months ex-works. This is a consumable module to SP-710 and SP-710B and will require scheduled replacements. Pyxis Lab recommends replacement of this module on a basis of every 9-12 months for preventative maintenance. In no event shall the standard limited warranty coverage extend beyond (6) months from original shipment date.

Warranty Service

Damaged or dysfunctional instruments may be returned to Pyxis for repair or replacement. In some instances, replacement instruments may be available for short duration loan or lease.

Pyxis warrants that any labor services provided shall conform to the reasonable standards of technical competency and performance effective at the time of delivery. All service interventions are to be reviewed and authorized as correct and complete at the completion of the service by a customer representative or designate. Pyxis warrants these services for 30 days after the authorization and will correct any qualifying deficiency in labor provided that the labor service deficiency is exactly related to the originating event. No other remedy, other than the provision of labor services, may be applicable.

Repair components (parts and materials), but not consumables, provided in the course of a repair, or purchased individually, are warranted for 90 days ex-works for materials and workmanship. In no event will the incorporation of a warranted repair component into an instrument extend the whole instrument's warranty beyond its original term.

Warranty Shipping

A Repair Authorization Number (RA) must be obtained from Pyxis Technical Support before any product can be returned to the factory. Pyxis will pay freight charges to ship replacement or repaired products back to the customer. The customer shall pay freight charges for returning products to Pyxis. Any product returned to the factory without an RA number will be returned to the customer.

Pyxis Technical Support

Contact Pyxis Technical Support at service@pyxis-lab.com or 1-866-203-8397 (Mo-Fri 7:00AM-5PM MT)

Table of Contents

1	Introducing the Pyxis SP-710B Multimeter.....	5
1.1	Features of the Pyxis SP-710B.....	5
1.2	Specifications	6
1.3	Unpacking the Pyxis SP-710B.....	6
1.4	Standard Accessories	6
1.5	Optional Accessories.....	7
1.6	Dual Function Seal for the pH/ORP Cell.....	7
2	Using the Pyxis SP-710B	8
2.1	Battery Installation.....	8
2.2	Turning the SP-710B ON and OFF	9
2.3	Turn on the pH/ORP Module Power.....	9
2.4	Using the SP-710B Control Keys.....	10
3	Multiple Parameter Measurement	10
3.1	PTSA and Conductivity Measurement	10
3.2	Fluorescein Measurement	11
3.3	pH and ORP Measurement	11
3.4	Temperature Measurement	13
3.5	Conductivity Temperature Compensation.....	13
3.6	High Color and Turbidity Warning	13
3.7	pH Measurement Principle	13
3.8	ORP Measurement Principle.....	14
4	Calibrating the SP-710B.....	14
4.1	PTSA Standalone Calibration (2 point with zero).....	15
4.2	Combined Calibration Procedure.....	15
4.3	Standard Conductivity Calibration (500, 1000, 2500, or 5000 μ S)	17
4.4	User-Defined Conductivity Calibration Procedure.....	18
5	pH and ORP Calibrations	19
5.1	pH Electrode Calibration	19
5.1.1	One-Point Calibration	20
5.1.2	Second-Point Calibration	20
5.1.3	Third-Point Calibration.....	20
5.2	ORP Calibration	21
6	Fluorescein Calibration	22
7	Device Information and Diagnosis	24
8	Device Maintenance	25
9	Replacing the pH/ORP module (Part #50313).....	25
9.1	Module Replacement.....	25
9.2	Bluetooth Pairing Your pH/ORP Module to SP-710B.....	27
10	Bluetooth Connection of SP-710B to Devices	27

11	Calibrate ST-500 with SP-710B	28
12	REGULATORY APPROVAL	30
13	Appendix. Cleaning Kit.....	31

1 Introducing the Pyxis SP-710B Multimeter

The Pyxis SP-710B is a handheld multimeter that measures five key parameters. It is a cuvette-less device. Less than 5 ml water sample is needed to fill the two sample cells for the measurement.

- pH
- Conductivity
- PTSA (Pyrene Tetrasulfonic acid Tetra Sodium)
- Fluorescein
- ORP
- Temperature

1.1 Features of the Pyxis SP-710B

The SP-710B includes the following features:

- Breakthrough technology combining PTSA/fluorescein with conductivity and pH/ORP in a single rugged meter.
- The PTSA measurement uses custom signal processing algorithms to compensate for sample color and turbidity interference.
- Modular pH/ORP design with extra-large junction capacity providing increased service life.
- Easy replacement of the pH/ORP module without the need to open the meter enclosure.
- The pH/ORP module can be used wirelessly and independent of the main module.
- Long battery life: 10,000+ readings.
- Self-diagnosis during calibrations.

1.2 Specifications

Specifications are subject to change without notice. Contact Pyxis (service@pyxis-lab.com) for an updated specification list.

Item		Specification
Analysis	PTSA	0-300 ppb, ± 1 ppb or 1% precision
	Fluorescein	0-600 ppb, ± 0.2 ppb for 0-50 ppb or 1% precision
	Conductivity	1-15,000 $\mu\text{S}/\text{cm}$ with ATC. $\pm 1\%$ or ± 1 $\mu\text{S}/\text{cm}$ precision
	pH	0-14 with ATC, ± 0.01 pH unit precision
	ORP	± 1500 mV, ± 1 mV precision
Temperature	0-70° C (32-160 °F), ± 0.1 °C (± 0.2 °F)	
Storage Temperature		-10 °C – 50 °C (-4 - 140° F)
Operational Temperature		0 °C – 40 °C (32 - 104° F)
Sensor Module		pH/ORP, replaceable – <i>recommended every 9-12 months</i>
Typical Sensor Life		pH/ORP - 1 year PTSA/Conductivity - 5 years
Protection Grade		IP67, Fully Dustproof & Waterproof
Regulation		CE
Display		Color LCD, Visible Under Direct Sunlight
Power Supply		4 AA alkaline batteries
Typical Battery Life		10,000 readings
Dimension (L x W x H)		208 x 80 x 45 mm (8.19 x 3.15 x 1.77 inches)
Weight		520 g (1.15 lbs) batteries excluded

1.3 Unpacking the Pyxis SP-710B

Remove the instrument and accessories from the shipping container and inspect each item for any damage that may have occurred during shipping. Verify that all items listed on the packing slip are included. If any items are missing or damaged, please contact Pyxis Customer Service at service@pyxis-lab.com. During shipping and storage after production, a sponge wetted with the KCl based pH storage solution is placed in the pH/ORP cell. You may also observe some residual dry storage solution leaving white potassium chloride crystal in the surrounding areas of the cell. Please rinse the cell with a water sample before use.

1.4 Standard Accessories

The following accessories are included in the SP-710B package:

- Four (4) AA alkaline batteries
- Bluetooth USB adapter (Part # MA-NEB)



The full instrument manual is available for download at www.pyxis-lab.com/support.html

1.5 Optional Accessories

The following optional accessories can be ordered from Pyxis Customer Service, order@pyxis-lab.com or Pyxis EStore at www.pyxis-lab.com/shop

Accessory	Item number
Replacement pH/ORP Module - Bluetooth	50315
Carrying Case for SP-710B	MA-700
100 ppb PTSA + 1000 μ S/cm (KCl) combined standard	PTSA-1010
220 mV ORP Calibration Standard	ORP-220
100 ppb PTSA Calibration Standard	PTSA-100
pH 4-7-10 Calibration Combination Kit	57007
1000uS Conductivity Calibration Standard	57008
50 ppb fluorescein calibration standard	FLUO-50
250 ppb fluorescein calibration standard	FLUO-250
500 ppb fluorescein calibration standard	FLUO-500

1.6 Dual Function Seal for the pH/ORP Cell

The SP-710B pH/ORP seal (Figure 1) has two functions:

- When the multimeter is in storage, the rubber seal seals the pH/ORP cell, maintaining a moist environment for the electrodes.
- The seal contains a permanent magnet. When being brought close to the front end of the module, the seal turns on pH/ORP module power.



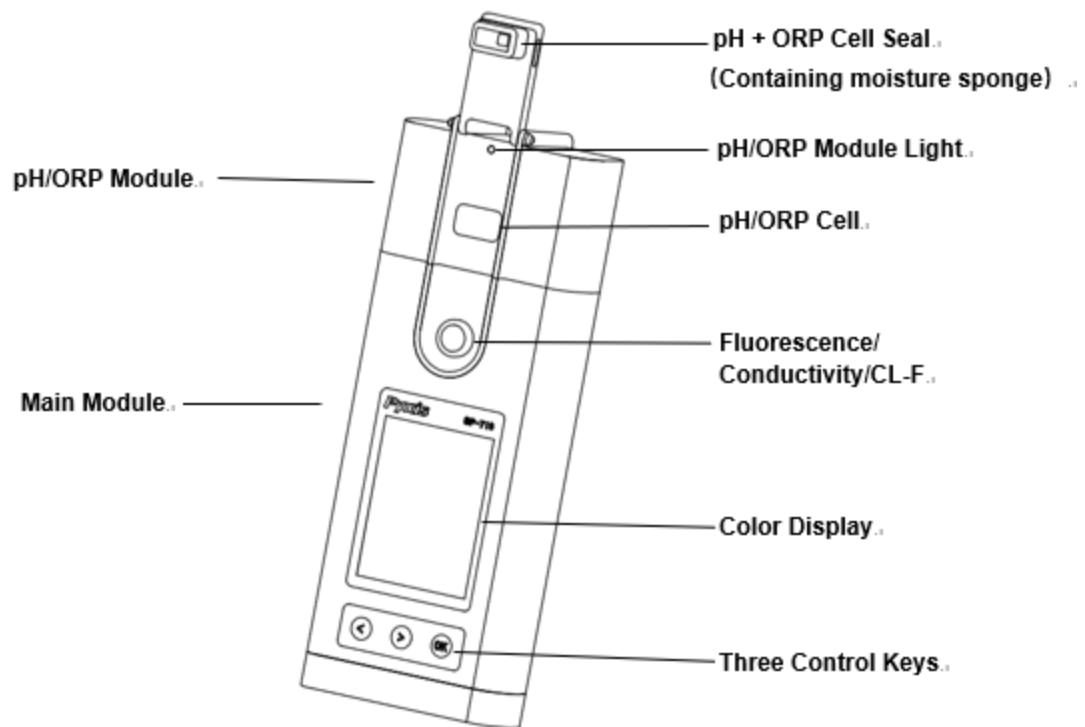

Figure 1. Seal in the open position

Please fill the pH/ORP cell with 1 ml of the pH 4 buffer solution or pH electrode storage solution at all times when not using the pH/ORP cell. **NOTE - The sponge soaked with the pH storage solution in the pH/ORP helps prolong the life of the pH/ORP module.**

2 Using the Pyxis SP-710B

2.1 Battery Installation

The main module of the SP-710B is powered by four AA alkaline batteries. Typical battery life is 10,000 measurements, or 10 months. When the battery capacity is critically low, the SP-710B displays a LOW BATTERY warning for five seconds, and then automatically turns off.

The SP-710B does not turn itself on automatically after the new battery installation. To turn on the SP-710B after new battery installation, press the **OK** key momentarily and release.

Maintaining SP-710B date and time during battery installation: The SP-710B has a calendar timer. To prevent the calendar from being reset to the default date and time (01/01/1970, 00:00:00), install the four new batteries within four minutes after the old batteries are removed from the battery compartment.

The SP-710B date and time is synchronized with your PC automatically when connected with **uPyxis©** app via Bluetooth adapter provided.

The SP-710B battery compartment, shown in Figure 2, is on the back side of the instrument. Batteries are held in place by a cover secured with two Phillips-head screws.

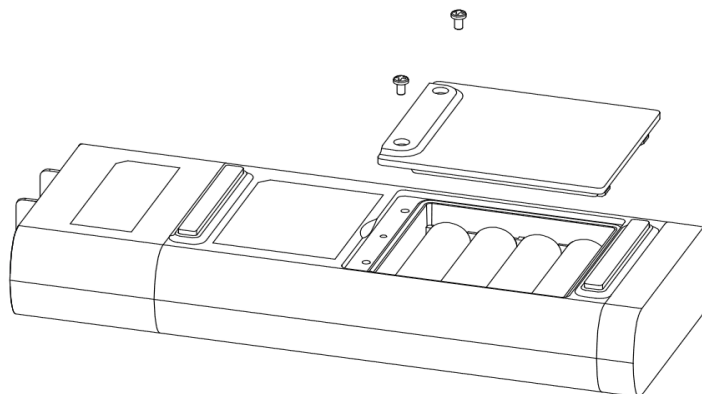

Figure 2. The SP-710B battery compartment

Use the following procedure to install new batteries:

1. Remove the battery compartment cover by loosening the two screws.
2. Remove the old batteries and dispose of properly.
3. Following the positive and negative terminal signs in the compartment bottom, snap four new AA alkaline batteries firmly into the battery holder.
4. Replace the battery compartment cover and ensure that the sealing O-ring is lying flat on the battery holder. **NOTE: Failure to properly seat the O-ring may result in water damage to the meter.**
5. Fasten the two screws.

2.2 Turning the SP-710B ON and OFF

To turn on the SP-710B: Press the **OK** key momentarily and release.

To turn off the SP-710B: Press and hold the **OK** key for three seconds. Release the **OK** key when the LCD display turns off.

The SP-710B turns itself off after 30 seconds without user interaction detected. This is done to conserve battery life.

2.3 Turn on the pH/ORP Module Power

The module has a permanently sealed 3.7 V lithium battery. The module is turned on by rotating the pH/ORP seal to touch the front face of the module. A sealed magnet within the rubber seal

will trigger the module power circuit. The pH/ORP module will turn itself off when either commanded by the main SP-710B module or automatically based on the idle time limit. The purpose for this design is to extend battery life.

If pH/ORP measurement is not needed, the module does not need to be turned on.

2.4 Using the SP-710B Control Keys

The SP-710B has three control keys, as shown in Figure 3. The left (<), right (>), and **OK** keys are used to launch actions indicated on the LCD screen directly above the keys. Note that the LCD screen is not a touch-enabled device; the labels above the keys indicate the function associated with the keys, and functions can be changed in different operation modes.

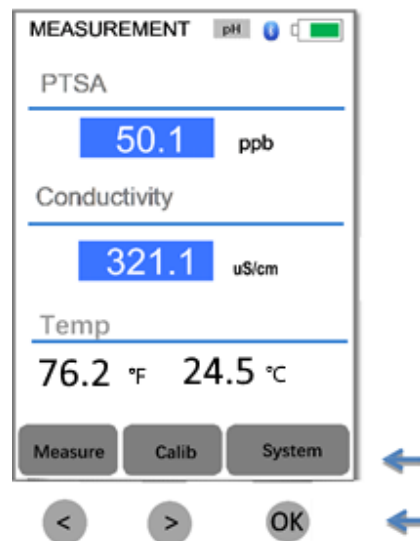

Figure 3. Control keys and associated functions

3 Multiple Parameter Measurement

3.1 PTSA and Conductivity Measurement

When powered on, the SP-710B is in the measurement mode of PTSA and Conductivity (as shown in Figure 3 above).

A water sample should be transferred to the PTSA cell using a pipette, or the cells can be filled directly from a sample bottle.

Rinse cells before measurement. Before beginning a measurement, use some of the sample water to rinse the cells at least three times.

Allow five seconds for the SP-710B to reach stable readings. The time required to reach a stable reading may be slightly longer if the water sample temperature is significantly different than the

environmental temperature at which the SP-710B had been equilibrated (stored). The values will be displayed in white with a blue background if a stable value is reached (Figure 3).

For a sample with conductivity in the range of 100 to 6000 $\mu\text{S}/\text{cm}$, the measured value should be stabilized in the range of 98–102 to 5940–6060 $\mu\text{S}/\text{cm}$, respectively. For a sample containing 100 ppb PTSA, the measured PTSA should be stabilized within the range of 98–102 ppb.

3.2 Fluorescein Measurement

The default measurement mode is for PTSA and conductivity. Press **Measure** (the < key) to launch the measurement selection menu and click **Measure** again to highlight **Flourescein**. Press the **OK** key to launch the fluorescein measurement page (Figure 4).

Fill the PTSA/Conductivity cell with the sample water. The fluorescein concentration will be displayed as shown in Figure 5.

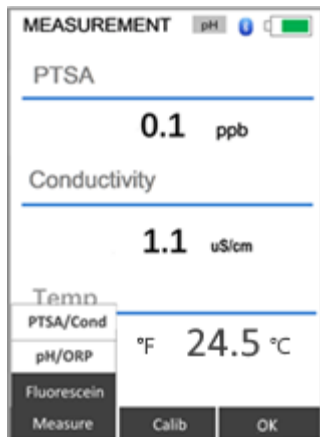

Figure 4. Select fluorescein measurement

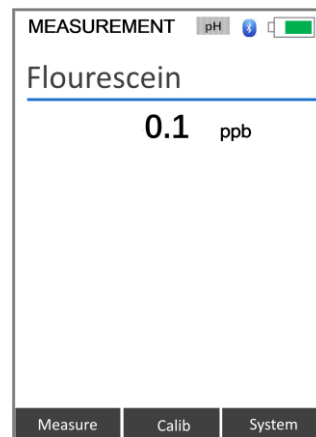

Figure 5. Flourescein measurement screen

3.3 pH and ORP Measurement

Follow the following steps to measure pH and ORP:

1. Lower the rubber seal down to touch the front face of the pH/ORP module (Figure 4). This is to power on the module. The indicator light of the module will be **green** and flashing when powered on. After the module is turned on, the seal can be positioned anywhere desired. If the module battery capacity is low, the indicator light will flash **red**.
2. Rinse the pH/ORP cell and fill in the sample water.
3. Press **Measure** (the < key). A selection menu will be shown as in Figure 6. Press **Measure** again to highlight **pH/ORP**. Press **OK** to start pH and ORP measurement. The pH and ORP values will be updated every two seconds. The values will be displayed in white with a blue background if a stable value is reached (Figure 7).

OFF/CLOSED POSITION

POWERED ON POSITION

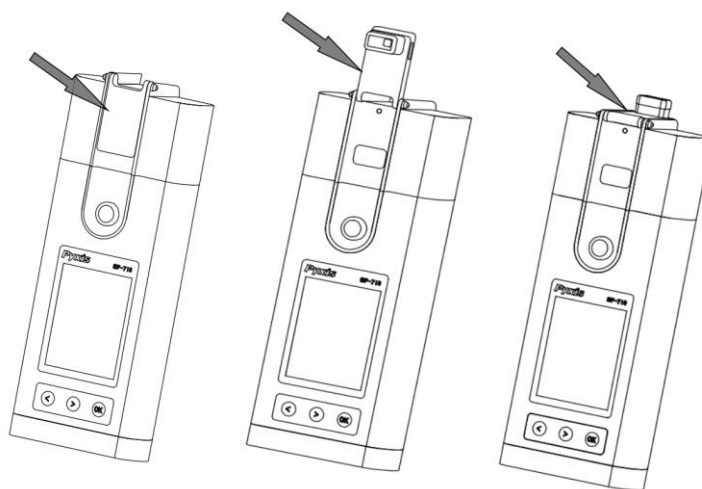

Figure 6. Turn on pH/ORP module with the seal

If step 3 is carried out to launch pH/ORP measurement from the main module without turning on the pH/ORP module first (i.e., skipping step 1), an instruction message will be promoted on the screen showing how to turn on the pH/ORP module (Figure 7). In this case, please turn on the pH/ORP module by lowering the seal according to the message shown.

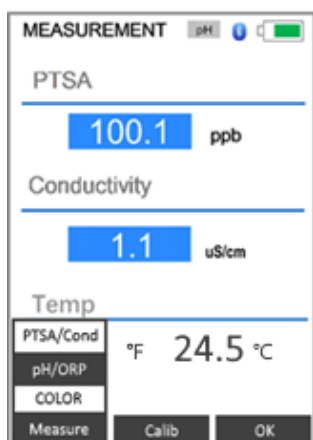

Figure 7. Select pH/ORP measurement

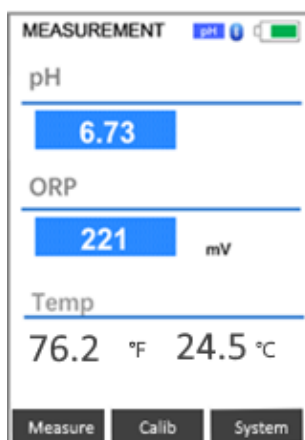

Figure 8. Display pH and ORP values

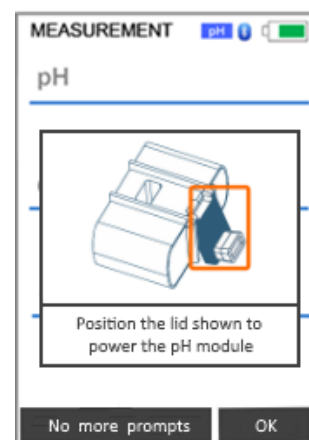

Figure 9. Instruction to turn on pH/ORP module

A erroneous pH value could be obtained if the module has been stored dry without the protection of the pH electrode storage solution for a long period. In this case, please fill the module cell with a pH storage solution to wet the electrode for 30 minutes before use. If these solutions are not available, please use the sample water to hydrate the electrode for 30 minutes.

3.4 Temperature Measurement

The SP-710B has two platinum RTDs located in the PTSA/Conductivity cell and the pH/ORP cell. The temperature sensors are individually calibrated in the factory and does not need to be calibrated during use. The temperature values measured is used in the conductivity temperature compensation and in converting the measured cell potential to the pH value at the sample temperature.

3.5 Conductivity Temperature Compensation

The displayed conductivity value is automatically corrected to the nominal value at the reference temperature 25.0 °C using the sample temperature measured. The commonly used linear correction equation is used:

$$\text{Conductivity at 25 °C} = (\text{Conductivity at } T_{\text{measured}}) / [1 + 0.02(T_{\text{measured}} - 25)],$$

where T_{measured} is the sample temperature in degrees Celsius.

3.6 High Color and Turbidity Warning

The SP-710B has extra channels to measure sample turbidity and color to automatically compensate for sample color and turbidity interference. If sample turbidity and color values determined are too high and beyond the compensation range, a PTSA measurement warning is displayed. In this case, the sample should be pre-filtered for PTSA measurement.

3.7 pH Measurement Principle

The SP-710B uses the standard electrochemical cell for the pH measurement. The cell consists of a glass electrode and an Ag/AgCl reference electrode. Potassium chloride (KCl) electrolyte filling gel is sealed in the Ag/AgCl electrode.

The amount of reference electrolyte in the SP-710B is significantly larger than that used in a common laboratory pH electrode. This reduces the chance of the filling solution being diluted or contaminated and increases the electrode life.

The pH value is calculated from the measured cell potential (EMF in mV):

$$\text{pH} = \text{EMF} / S(T) + \text{pH}_0$$

$S(T)$ in the above equation is the calibration slope and is theoretically equal to:

$$0.1986(T + 273.15)$$

where T is temperature in degrees Celsius.

$S(T)$ has a theoretical value of 59.17 mV at 25 °C. pH_0 is the calibration intercept. The calibration slope $S(T)$ at the nominal temperature 25.00 °C and the intercept pH_0 are determined in the two-

point or three-point calibration procedure. pH_o is determined as well in the single-point pH 7.00 calibration.

The temperature value measured by the SP-710B is used in the above equation to calculate the pH value at the measurement temperature. Note that the temperature compensation involved in the pH value calculation is quite different from that in the conductivity measurement. The temperature-compensated conductivity value is a would-be value at the reference temperature 25 °C, while the pH value displayed by the SP-710B is the true pH value at the sample temperature.

3.8 ORP Measurement Principle

The SP-710B measures the sample ORP with the platinum electrode and the Ag/AgCl reference electrode in the pH/ORP cell. The pH measurement and the ORP measurement share the same reference electrode. **Reporting an ORP value without specifying the reference scale has no meaning.** The ORP value reported by the SP-710B could be referenced to the standard hydrogen electrode (SHE), i.e., in the unit of Eh, or an Ag/AgCl electrode. **The value displayed by the SP-710B depends on the ORP value of the ORP standard used in the calibration.**

If the ORP value of the standard is referenced to the standard hydrogen electrode (SHE), the ORP value reported by the SP-710B is SHE-based, i.e., in the unit of Eh. If the ORP value of the standard is referenced to the Ag/AgCl (3M KCl) electrode, the ORP value reported by the SP-710B is referenced to the same, commonly noted as (Ag/AgCl, 3M KCl).

The ORP electrode is calibrated using the Zobell's standard using the value of 221 mV at 25 °C before shipping. The default ORP scale of the SP-710B before a user calibration is the Ag/AgCl (3M KCl).

It is difficult to measure ORP of a field sample accurately and precisely. ORP of water samples with low conductivity and low redox buffer capacity, such as unchlorinated surface water, is even more difficult to measure. If the SP-710B is exposed to an extremely high (>600 mV) or extremely low (< -200 mV) ORP sample, rinse the pH/ORP cell excessively when switching to measure a lower or higher redox buffer capacity sample is necessary.

The dissolved oxygen in the sample can contribute to the ORP value measured. To measure a sample that has not be equilibrated with the ambient air, a slow and small upward drifting to more positive ORP value is normal.

For a typical cooling water sample treated with oxidizing biocides, a ± 20 mV accuracy and ± 10 mV precision can be expected.

4 Calibrating the SP-710B

The PTSA, fluorescein, pH, ORP, and conductivity measurements can be calibrated separately using the corresponding standards.

PTSA calibration requires the 100, 200, or 300 ppb PTSA standard solution. A standard with conductivity value 500, 1000, 2500, or 5000 μS can be used to calibrate conductivity. Optionally,

you can use a standard with any conductivity value in the range of 500 to 5000 μS , such as the commonly used 1412 (or 1413) μS standard, to calibrate the SP-710B. For convenience, the SP-710B can be calibrated using a combined standard with 100 ppb PTSA + 1000 μS KCl conductivity available from Pyxis. Fluorescein calibration requires the 50, 250, and 500 ppb fluorescein standards.

4.1 PTSA Standalone Calibration (2 point with zero)

It is recommended that you use the PTSA standalone calibration procedure if you want to achieve higher accuracy for low range PTSA measurements (< 20 ppb). The Combined PTSA/Conductivity Calibration procedure yields the PTSA calibration slope only and does not change the zero point.

To use the PTSA standalone calibration procedure:

1. Rinse sample cell with DI water, and then fill the sample cell with DI water.
Note: In an emergency, “non-PTSA” water, such as city water, can be used.
2. Power the SP-710B on by pressing the **OK** key. Allow 5-10 seconds for meter to stabilize.
3. A screen like Figure 11 appears. The unit is actively reading and displaying both PTSA and Conductivity.
4. Press **Calib** (the < key). Press **OK** to select **PTSA** (alone) calibration, as shown in Figure 12
5. Press **Zero** to set the zero point, as shown in Figure 13.
6. After successful zero set, a checkmark symbol appears next to **Click Zero Button** to confirm success. The screen also updates to show the Slope steps, as in Figure 14. The **Cycle** command replaces the **Zero** command on the black bar, and the possible PTSA selection is displayed in red. The default is 100 ppb:
7. Rinse the sample cell out at least twice with the desired PTSA standard, and with the measurement cell near full.
8. If the 100 ppb PTSA default is not the desired PTSA for calibration, press **Cycle** to cycle among the PTSA standards 100-200-300 ppb. The value in red updates as the setting is being changed.
9. Press **Slope** to set the slope of the standard desired and complete PTSA calibration. If calibration is successful, the screen updates with a second checkmark for the Slope setting as shown in Figure 15, and the message Calibration Succeed appears.
10. Press **Exit** to return to the measurement screen. Slight variance in the PTSA value is acceptable. If you press **Exit** before the second checkmark appears, the calibration will not be completed and must be re-done.

4.2 Combined Calibration Procedure

The combined 100 ppb PTSA and 1000 μS calibration requires the Pyxis **PTSA-1010C** combined standard.

When Cond (conductivity) calibration is selected, the < or > keys can be used to cycle to different conductivity calibration modes. With each press various elements of the display update, such as the calibration title, the type (“Target”), and the black bar.

1. Rinse sample cell with the Combined Standard and close the light shield.
2. Power on by pressing the **OK** key. Allow 5-10 seconds for meter to stabilize.
3. Press **Calib** (the > key) to launch the calibration selection screen (Figure 12). Press **Calib** again to select **Cond** (conductivity) calibration. Press **OK** to start the calibration procedure. The default conductivity calibration screen is the Combined Calibration (Figure 16). This will calibrate both Conductivity (at 1000 μ S) and PTSA (at 100 ppb) when using the Pyxis PTSA-1010C combined standard.
4. Ensure the meter is filled with the Combined Standard and press **Calib** to confirm the desired calibration. A confirmation popup appears as in Figure 17.
5. Press the **OK** key to execute both conductivity and PTSA calibrations (skip steps 6 and 7).
6. Or, press **Cancel** (the < key) to return to the conductivity calibration type selection screen.
7. Or, press **Exit** (the > key) to abandon calibration.
8. If Combined Calibration is successful, the measured field updates to the target conductivity value (1000 μ S), or very close. A checkmark shows. The screen appears as in Figure 18.
9. After about one second, if the PTSA calibration is successful, the PTSA value is also displayed in the measured section below the conductivity value, and a checkmark appears. A small variance is acceptable. The message “Calibration Succeed” appears in red, as in Figure 19.
10. After successful calibration, press and hold **Calib** for three seconds to return to the basic measurement screen. Return is not automatic, except through a power-off cycle.

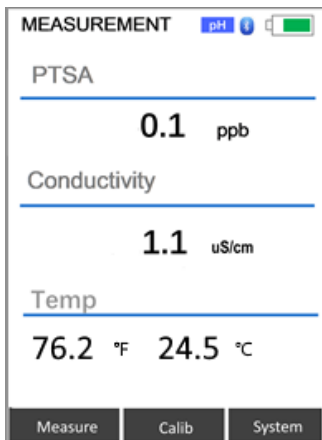

Figure 10. PTSA measurement screen

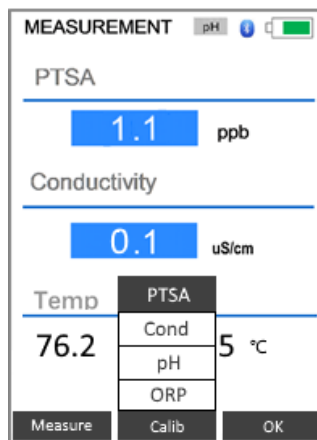

Figure 11

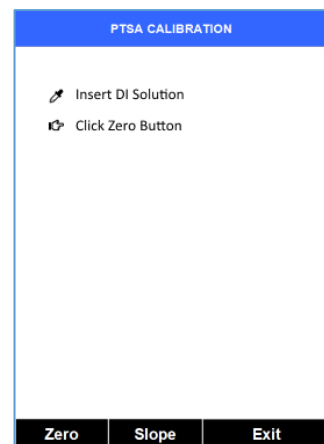

Figure 12

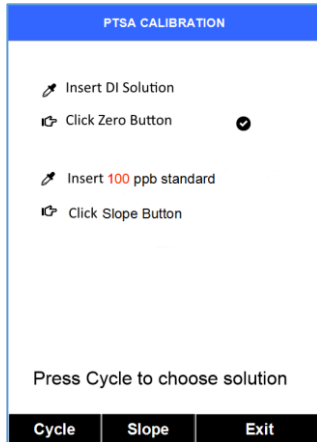

Figure 13



Figure 14

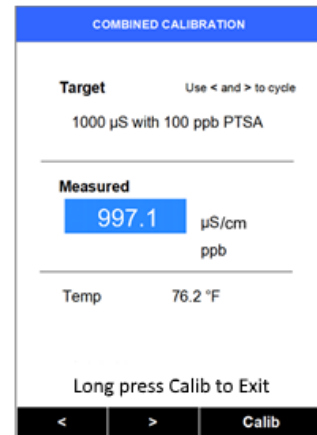

Figure 15

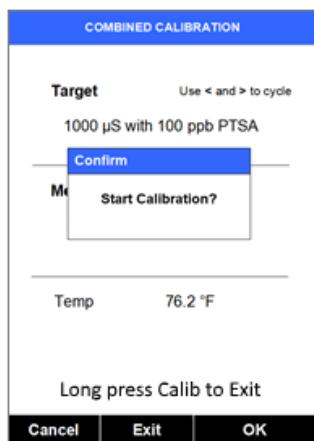

Figure 16

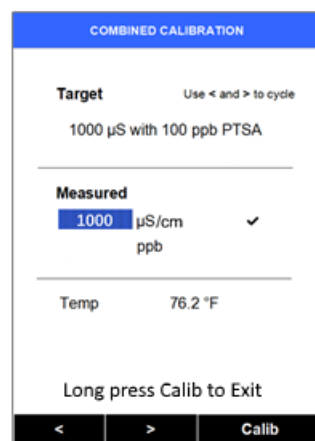

Figure 17

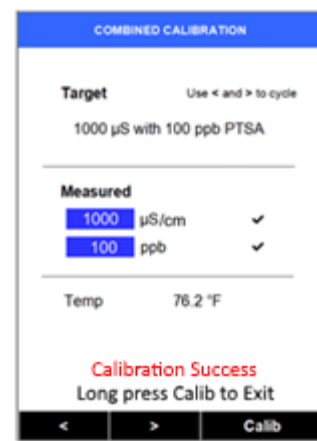

Figure 18

4.3 Standard Conductivity Calibration (500, 1000, 2500, or 5000 µS)

Example based on 1000 µS:

1. Rinse sample cell with the desired conductivity standard.
2. Power on by pressing the **OK** key. Allow 5–10 seconds for the meter to stabilize.
3. Press **Calib** (the > key) to launch the calibration selection screen (Figure 12). Press **Calib** again to select **Cond** (conductivity) calibration. Press **OK** to start the calibration procedure. A screen like Figure 16 appears. This is the default combined Calibration mode, which requires the Pyxis combined standard.
4. Use the > key to cycle to the desired calibration, for example, 1000 µS (Figure 20). The Standard Conductivity selections are 500, 1000, 2500, and 5000 µS.
5. Press **Calib** to confirm the specific conductivity calibration desired. The screen updates as shown in Figure 21.

6. To start the calibration, press **OK** control key (skip steps 9 and 10).
7. Or, press **Cancel** (the < key) to return to the Conductivity calibration selection screen (Figure 21). You can change the conductivity calibration type by using the > or < control keys.
8. Or, press **Exit** (the > key) to abandon calibration.
9. After successful conductivity calibration, the meter reads the sample and displays the value in the measured section. A slight variance from the target is acceptable. A message displays in red: "Calibration Succeed." The meter display appears like Figure 22.
10. After successful calibration, press and hold **Calib** for three seconds to return to the basic measurement screen. Return to this mode is not automatic except through a power-off cycle.

4.4 User-Defined Conductivity Calibration Procedure

1. Rinse sample cell with desired conductivity standard.
2. Power on by pressing the **OK** key. Allow 5-10 seconds for meter to stabilize.
3. Press **Calib** (the > key) to launch the calibration selection screen (Figure 12). Press **Calib** again to select **Cond** (conductivity) calibration. Press **OK** to start the calibration procedure. A screen like Figure 16 appears. This is the default combined Calibration mode, which requires the Pyxis combined standard.
4. Press the < key. A screen like Figure 23 appears.
5. If the displayed Target numeric value is not that the value you want, use the keys labeled – and + (the < and > keys) to adjust the value as desired. Holding a key down scrolls the values at a faster rate. Once the value is as desired, press **Set** to confirm the numeric value to be used. The black bar updates as in Figure 24 (The label above the **OK** key now changes to **Calib** from **Set**). Press **Calib**. The screen updates to Figure 25 with the confirmation popup.
6. Press **OK** to execute the User Defined Conductivity calibration (skip steps 8 and 9).
7. Or, press **Cancel** to return to the User Defined Calibration (as in Figure 23), where the desired User Defined calibration numeric value can be changed.
8. Or, press **Exit** to abandon calibration.
9. After successful User Defined calibration, the meter reads the sample value and displays the value in the measured section. A message displays in red "Calibration Succeed."
10. After successful calibration, press **Calib** for three seconds, to return to the basic measurement screen. Return to this mode is not automatic except through a power-off cycle.

If the user defined conductivity calibration mode is cycled to accidentally, the < key and > key cannot be used to cycle out this mode. Please press **Set** (the **OK** key), and then press and hold the **OK** key for three seconds to exit this mode. Or abandon the user defined calibration at step 8 above.

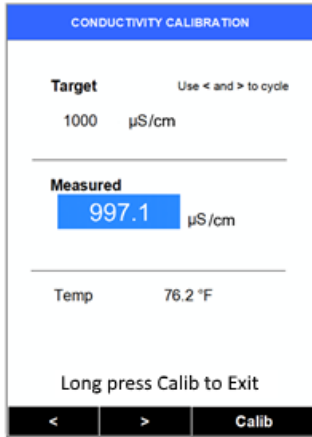

Figure 19

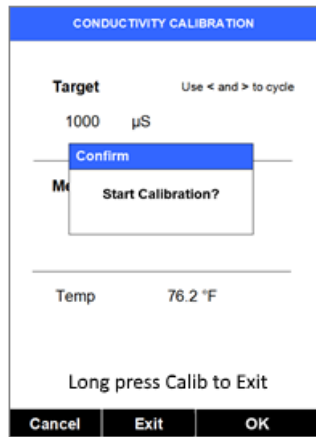

Figure 20



Figure 21

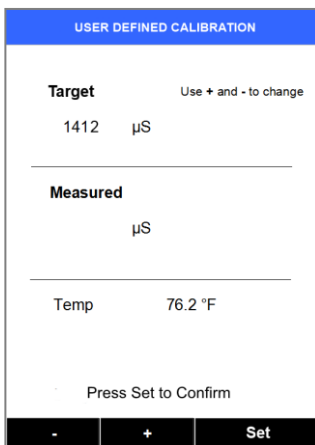

Figure 22

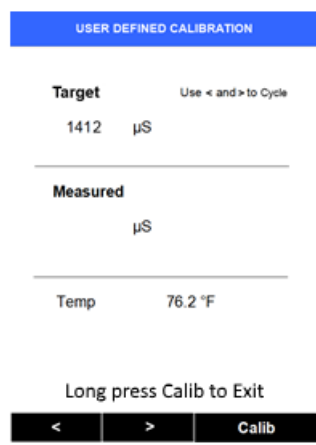

Figure 23

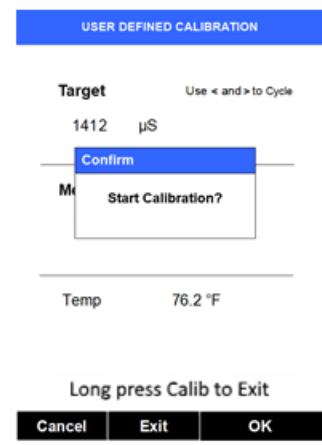

Figure 24

5 pH and ORP Calibrations

The commonly used pH 4.00, 7.00, and 10.00 buffer standards can be used to calibrate the SP-710B pH measurement.

Unlike the pH calibration, ORP calibration procedure and the calibration standards are not standardized by the industry or government institutions. We recommend that you use Zobell's ORP standards (or **Pyxis ORP-220**) to calibrate the SP-710B and pay attention to the reference electrode on which the ORP value is referenced. The reference information must be specified by the standard supplier.

5.1 pH Electrode Calibration

The SP-710B software is designed to provide a flexible calibration procedure. You can start with the one-point pH 7 calibration and progressively add a second point and a third point calibration with the pH 4 buffer and the pH 10 buffer. This allows you to choose a procedure based on the need of measurement accuracy and the target pH range.

Starting the pH calibration: After the meter and the pH/ORP module are powered on, press **Measure** to switch to the pH measurement page. Press **Calib** to start the pH calibration procedure.

5.1.1 One-Point Calibration

Rinse the pH/ORP cell three times with the pH 7 buffer and fill the cell with the pH 7 buffer.

Press **pH-7** (the < key) to start one-point calibration. A checkmark after **Click pH-7** is displayed if the calibration succeeds (Figure 26). Otherwise a warning message is displayed.

5.1.2 Second-Point Calibration

When the one-point pH 7 calibration is complete, press **Exit** to exit, or continue to the pH 4 or pH 10 calibration. If a second buffer is added into the cell, the SP-710B automatically determines the buffer pH and displays the determined buffer pH value for confirmation.

If you choose the pH 4 buffer to do the second-point calibration, the pH 4 buffer is identified and the value 4.00 is shown. Press **Calib** to complete the pH 4 calibration. A checkmark after **Click pH-4** is displayed if the calibration succeeds (Figure 27). Otherwise a warning message is displayed.

Alternatively, you can use the pH 10 buffer for the second-point calibration.

5.1.3 Third-Point Calibration

When the second-point calibration is complete, press **Exit** to exit, or continue to a third-point calibration. If you have used the pH 4 buffer in the second-point calibration, you must use the pH 10 buffer for the third-point calibration.

Rinse the pH/ORP cell three times and fill the cell with the pH 10 buffer. The pH 10 buffer is automatically identified. Press **Calib** to complete the third-point calibration. A checkmark after **Click pH-10** is displayed if the calibration succeeds (Figure 28). Otherwise a warning message is displayed. Press **Exit** to finish the final calibration process.

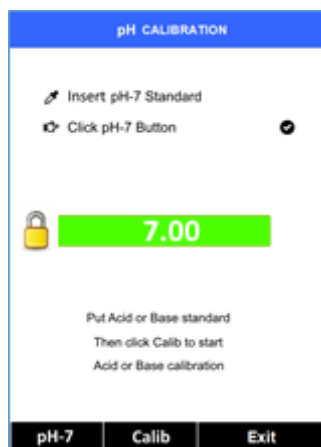

Figure 26



Figure 27

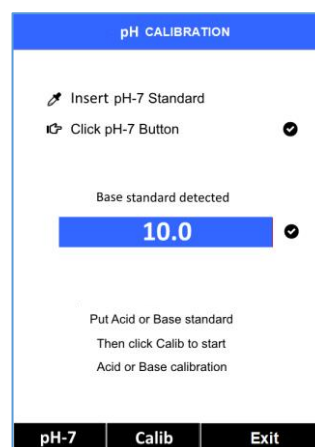

Figure 28

5.2 ORP Calibration

Launch the pH/ORP measurement page. Press **Calib** to launch the pH/ORP calibration selection dropdown. Press **Calib** again to move the selection to ORP. Press **OK** to start ORP calibration.

Press **+** or **-** to select an ORP value to match your ORP standard. Press **Calib** to complete the calibration.

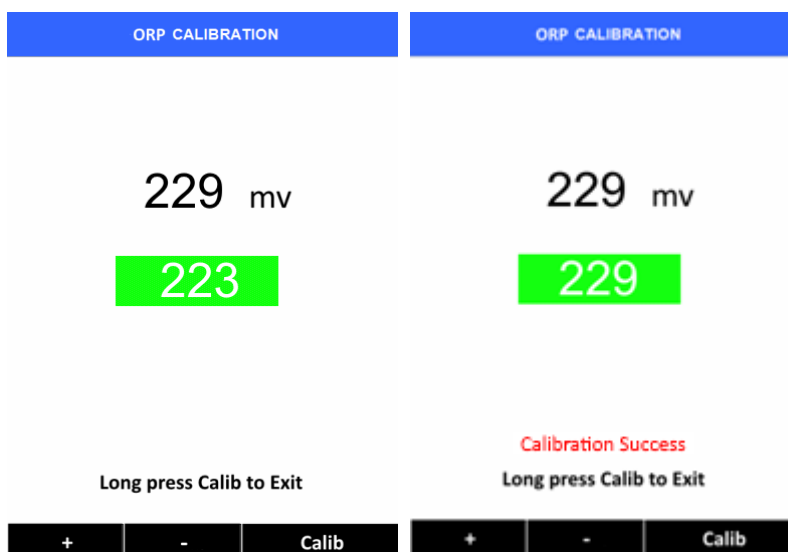

Figure 29

The ORP scale of the SP-710B depends on the ORP scale of the calibration standard. For example, if the value of 220 mV for the common Zobell's standard at 25 °C is entered in the above calibration, the ORP value reported by the SP-710B after calibration is referenced to the Ag/AgCl(3M KCl) scale. This is because the value of 220 mV is based on the Ag/AgCl(3M KCl) reference electrode. If the value entered in the above calibration is 429 mV, the ORP value reported by the SP-710B is referenced to the SHE, because the value of 429 mV at 25 °C for the Zobell's standard is SHE based.

The value in the following table can be used to convert the Ag/AgCl reference electrode based ORP value to the SHE-based ORP value. To obtain the SHE-based ORP value, add the number in the table to the corresponding Ag/AgCl reference electrode-based value. To use the table, the temperature of the standard solution measured by the SP-710B must be used.

Temperature	Ag/AgCl (1M KCl)	Ag/AgCl (3M KCl)	Ag/AgCl (saturation KCl)
68 °F (20 °C)	+234	+213	+202
77 °F (25 °C)	+231	+209	+199
86 °F (30 °C)	+228	+205	+196

6 Fluorescein Calibration

Deionized water (DI) and 50 ppb, 250 ppb or 500 ppb fluorescein standard solutions are required to calibrate the SP-710B fluorescein measurement.

1. Rinse sample cell with DI water, and then fill the sample cell with DI water.
2. Power the SP-710B on by pressing **OK**. Allow 5-10 seconds for meter to stabilize.
3. Press **Measure** (the < key) until Fluorescein is highlighted in the measurement selection menu. Press **OK** to launch the fluorescein measurement page.
4. Press **Calib** once. Fluorescein will be selected in the calibration selection menu (Figure 25).
5. Press **OK** to start fluorescein calibration. A page as shown in Figure 26 will be shown.
6. Press **Zero** to set the zero point.
7. After successful zero set, a checkmark symbol appears next to **Click Zero Button** to confirm success. The screen also updates to show the Slope steps, as in Figure 27. The **Cycle** command replaces the **Zero** command on the black bar, and the possible fluorescein selection is displayed in red. The default is 50 ppb:
8. Rinse the sample cell out thoroughly with the desired fluorescein standard, and with the measurement cell near full.
9. Press **Slope** to set the slope of the standard desired and complete low-range fluorescein calibration.
10. If calibration is successful, the screen will update with a second checkmark for the Slope setting as in Figure 28, and the message Calibration Succeed will appear.
11. Press **Continue** to continue middle range fluorescein calibration (Figure 28). The possible fluorescein selection is displayed in red. The default is 250 ppb. If middle range and high range fluorescein calibration are not required, press the key labeled **Exit** to return to the main screen.
12. Rinse the sample cell out thoroughly with the 250 ppb fluorescein standard and with the measurement cell near full.
13. Press **Slope** to set the slope of the standard desired and complete middle-range fluorescein calibration.
14. If calibration is successful, the screen will update with a third checkmark for the Slope setting as in Figure 30, and the message Calibration Succeed will appear.
15. Press **Continue** to continue high range fluorescein calibration (Figure 30). The default fluorescein selection is displayed in red. If high range fluorescein calibration is not required, press **Exit** to exit to the main screen.

16. Rinse the sample cell out thoroughly with the 500ppb fluorescein standard and with the measurement cell near full.
17. Press **Slope** to set the slope of the standard desired and complete high-range fluorescein calibration.
18. If calibration is successful, the screen will update with a fourth checkmark for the Slope setting as in Figure 32, and the message Calibration Succeed will appear.
19. Press **Exit** to return to the main screen.

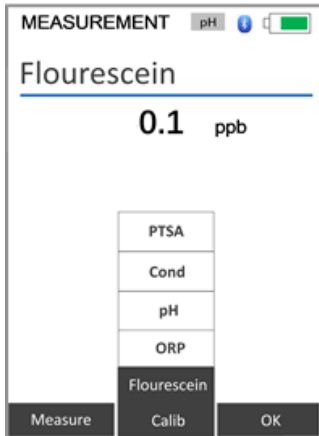

Figure 25. Select fluorescein calibration

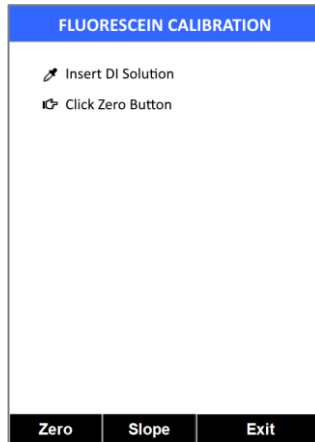

Figure 26

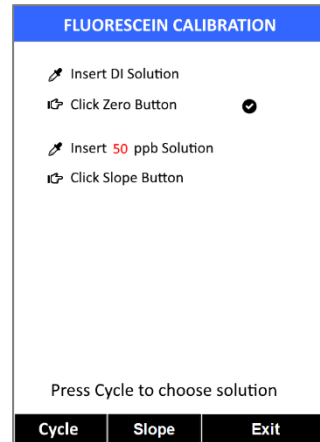

Figure 27

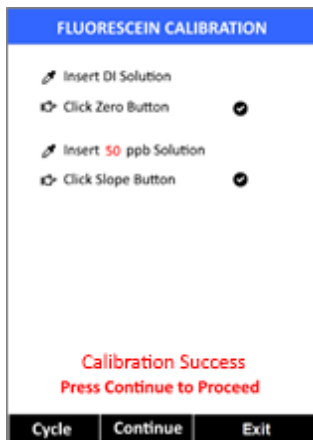

Figure 28

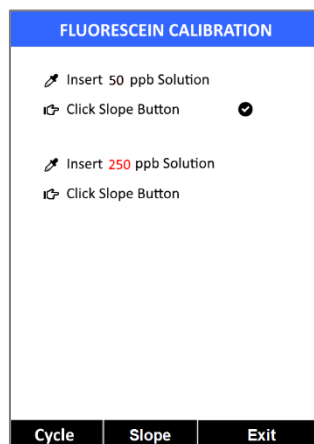

Figure 29

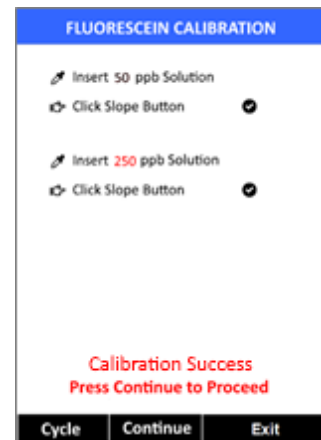

Figure 30

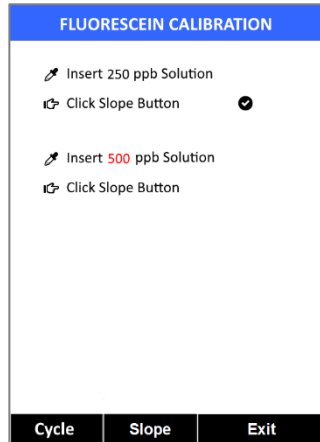

Figure 31



Figure 32

7 Device Information and Diagnosis

Device information is shown when the key labeled **System** in any Measurement mode is pressed momentarily (Figure 3). The screen contains the device serial number, software version, and hardware version (Figure 32). The battery life as a percentage and the standard that was used in the last calibration are also shown.

Press the key labeled **Diagnosis** to switch to the Diagnosis screen where raw measurement data are displayed (Figure 33). (The information has no use for normal operation.) Provide an image of both the device information screen and the diagnosis screen when you contact Pyxis (service@pyxis-lab.com) for troubleshooting your device or call 1-866-203-8397.

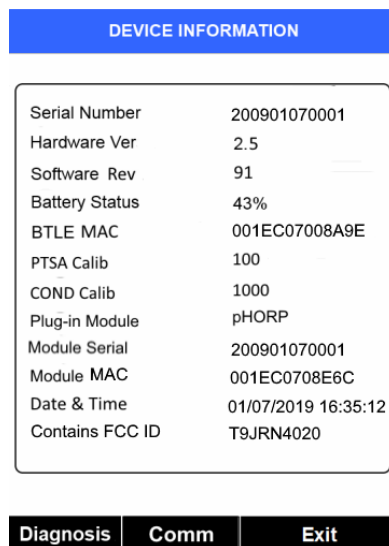

Figure 32

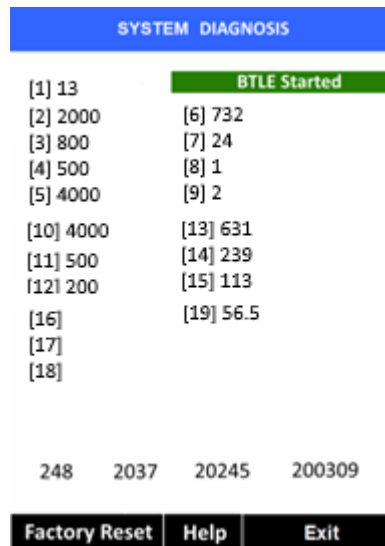

Figure 33

8 Device Maintenance

The working life of the SP-710B is greatly increased if you follow these maintenance best practices:

- Rinse the meter with tap water or DI water after measurement, and remove residual water using a paper towel.
- Close the pH/ORP seal firmly to keep the pH and ORP cell wet.
- Add the pH storage solution to the pH/ORP cell at all times when the meter is not being used.
- Use a Q-tip to gently clean the inside of the fluorescence and conductivity cell to remove any deposits that may have attached to the optical and electrode surfaces.
- On a monthly basis or as needed we recommend conducting a chemical cleaning using Pyxis **SER-02 Handheld Cleaning Solution** of the fluorescence and conductivity cell to remove deposition or film development.
- Completely wet the fluorescence and conductivity cell for an hour before a measurement if the meter has not been used in more than two weeks.
- Do not expose the SP-710B to an extreme high or low temperature condition such as leaving the meter inside an unattended automobile. The pH electrode can survive a few short period exposures to -18 °C (0 °F) or 60 °C (140 °F). **Repeated extreme low and high temperature cycling can damage the pH electrode.**

9 Replacing the pH/ORP module (Part #50313)

9.1 Module Replacement

The pH/ORP module in the SP-710B can be replaced when the original module reaches the end of its working life. Pyxis offers a 6-month warranty on the pH/ORP module. Pyxis recommends replacing the module at a frequency of every 9-12 months as a best practice.

If the module is turned on for 20 minutes a day, the module battery can last for about a year. The module indicator light will flash red if the module battery is low.

Order a replacement module from Pyxis, asking for options with modules that the battery can be replaced. Follow the instructions below to install the replacement module:

1. Turn off the meter.
2. Ensure that there is no water in the two measurement cells.
3. Detach the spent pH/ORP module by pulling the module away from the main module
4. Attach a new pH/ORP module to the main module as shown in Figure 36

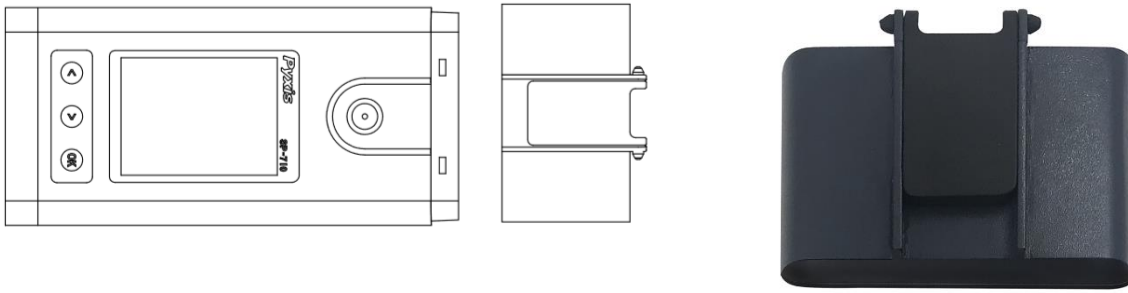

Figure 34. pH/ORP module (Part #51303) replacement

9.2 Bluetooth Pairing Your pH/ORP Module to SP-710B

1. Turn on the main module.
2. Press **System** (the > key) to launch the device information screen as shown in Figure 32.
3. Press **Comm** (the > key) to launch the communication screen (Figure 35).
4. Turn on the pH/ORP module by lowering the seal to touch the front face of the module. The module indicator light will flash green.
5. Press **Scan** (the < key) on the main module. The information of the discovered module will be listed as shown in Figure 36.
6. Press **Pair** (the > key) to pair the pH/ORP module to the main module. If pairing is successful, message “Pair Success!” will be shown the top of the screen as shown in Figure 37.



Figure 35



Figure 36



Figure 37

10 Bluetooth Connection of SP-710B to Devices

The Pyxis SP-710B can be connected to a smart phone or a computer via the built-in Bluetooth Low Energy Connection (BTLE). The uPyxis© app for smartphone is available for free download to both Apple and Samsung devices per QR codes below.

A laptop with uPyxis© app can use the Bluetooth Adapter (MA-NEB) included with the SP-710B as a standard accessory to connect to the SP-710B for parameter configuration, firmware upgrade, and other tasks. The Pyxis uPyxis software can be downloaded from www.pyxis-lab.com/support.html



Figure 38. *Pyxis Inline Bluetooth Adapter (MA-WB)*

uPyxis© App

Bluetooth Adapter For PC (MA-NEB)

The SP-710B can scan, discover, and calibrate a nearby Pyxis inline probe with the Pyxis Inline Bluetooth Adapter (MA-WB) connected between the Pyxis inline probe & controller (see next section).

The SP-710B can be paired with other Pyxis devices for exchanging data over Bluetooth. In the normal operation modes, the Bluetooth function is turned off. To turn on the Bluetooth wireless function, press **System**, and then press **Comm**.

Other SP-710B wireless functions are available. For more information, contact Pyxis Lab (service@pyxis-lab.com) or call at 1-866-203-8397.

11 Calibrate ST-500 with SP-710B

The SP-710B can be used to verify the result of inline Pyxis ST-500 and other probes by measuring the sample water taken from the inline probe sample line. The SP-710B can then be used to calibrate the inline probes over the Bluetooth connection.

Press **System** and then **Comm** to enter the communication module. The following interface appears on the screen.

Press **Scan**. A list of accessible ST-500s is displayed. Use the >> key to select the one to be calibrated. Press **Connect** to connect the SP-710B to the selected ST-500.

When the connection is established, the SP-710B reads the latest reading from the connected ST-500 and displays the reading as shown in Figure 41.

Use the SP-710B meter to measure the sample water by pressing **Read**. The PTSA value is displayed on the screen below the ST-500 readings, as shown in Figure 41. Press **Calib** to send the calibration instruction to the ST-500 via Bluetooth connection.



Figure 39

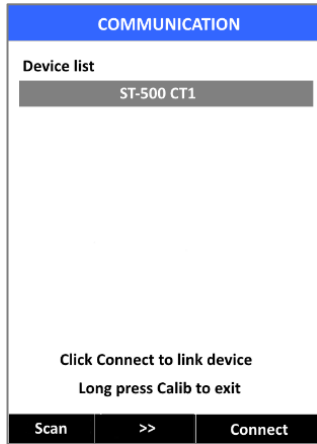

Figure 40

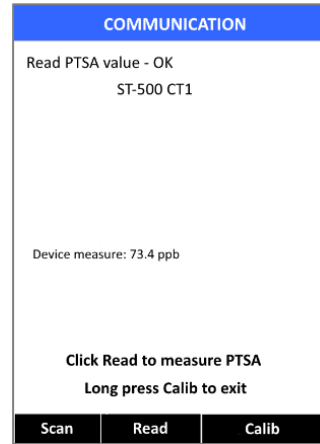

Figure 41

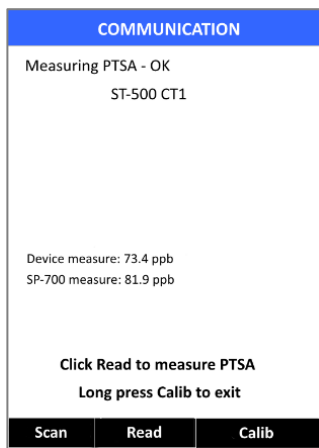

Figure 42

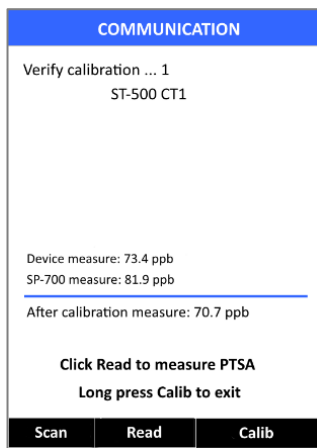

Figure 43

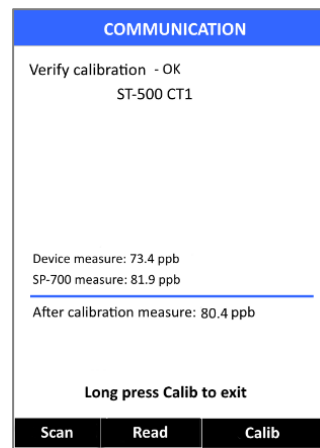

Figure 44

After that, the connected ST-500 is calibrated to the value measured by the SP-710B. The SP-710B reads the ST-500 three times to verify that the calibration is successful. Note that it takes about one minute for the ST-500 to approach the calibrated reading, and the three verifying readings may not be the same as the value measured by the SP-710B (as demonstrated in Figure 44). Press **Read** again to take more readings from the ST-500 if necessary.

12 REGULATORY APPROVAL

United States

The SP-710B sensor has been tested and found to comply with the limits for a Class B digital device, pursuant to part 15 of the FCC Rules. These limits are designed to provide reasonable protection against harmful interference in a residential installation. This equipment generates, uses and can radiate radio frequency energy, and if not installed and used in accordance with the instructions, may cause harmful interference to radio communications. However, there is no guarantee that interference will not occur in an installation. If this equipment does cause harmful interference to radio or television reception, which can be determined by turning the equipment off and on, the user is encouraged to try to correct the interference by one or more of the following measures:

- Reorient or relocate the receiving antenna.
- Increase the separation between the equipment and receiver.
- Connect the equipment into an outlet on a circuit different from that to which the receiver is connected.
- Consult the dealer or an experienced radio/TV technician for help

Canada

This device complies with Industry Canada license exempt RSS standard(s). Operation is subject to the following two conditions: (1) this device may not cause interference, and (2) this device must accept any interference, including interference that may cause undesired operation of the device.

Le présent appareil est conforme aux CNR d'Industrie Canada applicables aux appareils radio exempts de licence. L'exploitation est autorisée aux deux conditions suivantes: (1) l'appareil ne doit pas produire de brouillage, et (2) l'utilisateur de l'appareil doit accepter tout brouillage radioélectrique subi, même si le brouillage est susceptible

Contact us

Contact us if you have questions about the use or maintenance of the SP-710B Water Multimeter:

Pyxis Lab, Inc.

1729 Majestic Dr. Suite 5
Lafayette, CO 80026 USA
1-866-203-8397

www.pyxis-lab.com

service@pyxis-lab.com

13 Appendix. Cleaning Kit



DATASHEET

Cleaning Kit For Pyxis Handheld Devices

The Pyxis Handheld Devices from Pyxis Lab have proven to be an industry leader in accurately detecting PTSA fluorescent tracer in cooling and process water applications while compensating for color and turbidity. We've found that our cleaning solution also helps ensure the accuracy of your pH, Conductivity, & Free Chlorine readings if your one of our multifunctional handheld devices. Pyxis recommends a minimum cleaning frequency of once per month be maintained dependent on application needs and foulant level. High stress applications with excessive suspended solids and corrosion/scale by-product can result in the need to increase the frequency of cleaning your handheld device. For field use, Pyxis has developed a custom field cleaning kit for all your Pyxis handheld devices specifically designed to target a wide variety of inorganic deposits and foulants commonly experienced in cooling water applications.



<https://www.youtube.com/watch?v=OJDnCOjw7-M>

Product Details

- Custom Blend of Organic Acid/Reducing Agent & Surfactant
- Targets Inorganic Fouling & Deposition within your Handheld devices
- Will Not Damage your Handheld Devices
- 250 mL Bottle = Sufficient For 25 Cleanings
- Probe Cleaning Procedure Provided on Bottle
- Q-Tips & Pipe Brush Cleaner Included

Procedure

- Soak your handheld device in 10 mL of cleaning kit solution & allow to soak for 30 minutes
- Then use cotton swab or pipe cleaner to gently remove excessive deposit after soaking
- Rinse with DI water then check for flashing blue light inside your handheld device
- If surface is not entirely clean soak the device for an additional 30 minutes then repeat check

Ordering Information

Handheld Device Field Cleaning Kit

P/N: SER-02

1729 Majestic Drive Ste 5, Lafayette CO, 80026, USA | info@pyxis-lab.com | +1(866) 203-8397