

EX2000RS

Toroidal

Conductivity

Transmitter

Operation
Manual

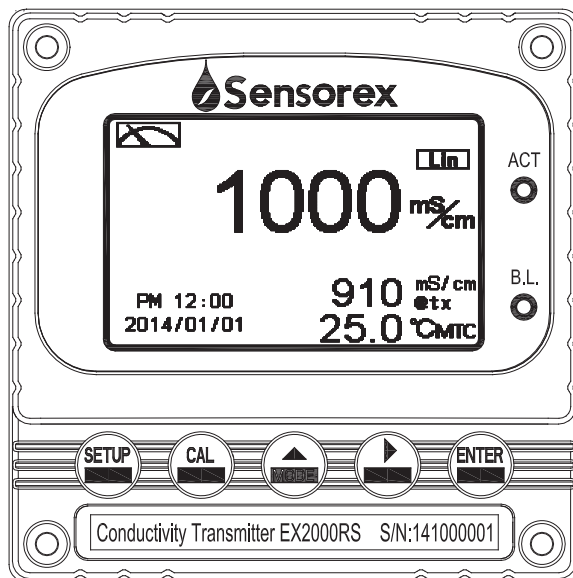

CONTENTS

Precautions for installation

Brief Instruction	1
1. Specifications	
1.1 Specifications	4
1.2 Measurement principle	6
2. Assembly and installation	
2.1 Transmitter installation	8
2.2 Illustration of panel mounting	8
2.3 Illustration of wall mounting and pipe mounting	9
3. Overview of Toroidal Conductivity Transmitter EX2000RS	
3.1 Illustration of rear panel	10
3.2 Illustration of terminal function	10
3.3 Description of terminal function	11
3.4 Circuit of cable	12
3.5 Illustration of electrical connection	13
4. Configuration	
4.1 Illustration of front panel	15
4.2 Keypad	15
4.3 LED indicators	15
5. Operation	
5.1 Measurement mode	16
5.2 Set-up menu	16
5.3 Calibration menu	16
5.4 Shortcuts	16
5.5 Default value	
5.5.1 Setting default value	16
5.5.2 Calibration default value	17
6. Measurement display mode	
6.1 Text mode	18
6.2 Real-time chart mode	19
6.3 Trace mode	20
6.4 Warning symbols and text	21

7. Settings



Block diagram of settings.....	22
7.1 Entry of set-up menu.....	24
7.2 Security code of settings(Code).....	25
7.3 Language.....	26
7.4 Measurement parameters(Mode).....	27
7.4.1 Conductivity with temperature compensation.....	27
7.4.2 Absolute conductivity.....	29
7.4.3 Concentration.....	31
7.4.3.1 Defined concentration table.....	33
7.4.4 TDS.....	37
7.4.5 Salinity.....	38
7.5 Product adjustment.....	39
7.6 Temperature.....	40
7.7 Temperature compensation coefficient.....	41
7.8 Relay 1.....	43
7.9 Relay 2.....	44
7.10 Clean.....	45
7.11 Current output.....	46
7.12 RS-485 communication.....	48
7.13 Date/Time (Clock).....	49
7.14 Sample average of measurements (Digital filter).....	50
7.15 Backlight.....	51
7.16 Contrast.....	52
7.17 Logbook.....	53
7.18 Automatically back to measurement mode(Return).....	54

8. Calibration









Block diagram of Calibration.....	55
8.1 Enter calibration menu.....	56
8.2 Security password of calibration.....	57
8.3 Zero-point calibration.....	58
8.4 Cell constant calibration.....	59
8.5 Standard solution calibration(Std. solution).....	60
8.5.1 KCl standard solution.....	60
8.5.1 NaCl standard solution.....	62
8.6 Automatically back to measurement mode(Return).....	64

9. Modbus protocol and instructions	65
9.1 Communication connection.....	65
9.2 Modbus address table.....	67
9.3 Modbus example descriptions.....	72
10. Error messages (Error code)	73
Appendix: Calibration solution	78



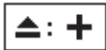

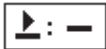

Description of set-up settings (see chapter 7 for details)











Press  and  simultaneously to see the overview of the set-up settings now. Then press  if you would like to modify set-up settings. Press keypad according to index of keypad on the screen.

Index of keypad

Keypad	Corresponding icon	Description
		Back to upper layer
		Choose change to left page
		Increase digit
		Choose change to right page
		Decrease digit
		Confirm settings after modifications and then go to next step

Selection of set-up items

Keypad	Corresponding icon	Description
Mode		Measurement mode, to choose Conductivity with temp. compensation (Cond.@tref), Concentration, TDS, Salinity or Absolute Conductivity (Cond.@tx) and measurement mode can be displayed in Text Mode, Real-time Mode, or Trace Mode.
Product Adj.		Sample reading adjustment as process calibration function
Temperature		Temperature measurement and compensation, including MTC (Manual Temperature Compensation), and auto temperature compensation: PT-1000, or NTC-30K.
Compensation		Temperature compensation setting, selection from linear(Lin.), non-linear(Non-Lin.), Off-compensation(Lin., 0.0%)
Relay 1		First relay setting, to choose action off or Hi/Lo alarm
Relay 2		Second relay setting, to choose action off or Hi/Lo alarm

Clean		Automatic wash time setting, to choose electrode cleaning equipment's ON and OFF duration
Current Output		Current output according to Cond.@tref, Concentration, TDS, Salinity, or Cond.@tx setting range
RS-485		RS-485 serial interface (Modbus protocol)
Clock		Clock setting (The instrument should retain the time setting during power outage or reset. If this does not happen replace the inner 3V CR2025 battery.)
Digital Filter		Take every serial 1~60 measurements, average them continuously, and make it as the readings
Back Light		Backlight setting, to set Auto/ON/OFF backlight, brightness, and sensitivity
Contrast		Screen Contrast
Logbook		Event records logbook (50 data points)
Return		Setting of returning to the measurement mode
Code		Security code of set-up mode. The set-up code is before the calibration code, and can be set as different value than security code of calibration.
Languages		English, Traditional Chinese, Simplified Chinese

1.1 Specifications

Model		EX2000RS
Measuring modes		Conductivity/TDS/Salinity/Temp./Concentration
Ranges	Conductivity	0.0 μ S/cm ~ 2,000 mS/cm, Auto or Fixed
	Salinity	0.0 ppt~70.0 ppt
	TDS	0 ~19,999 ppm; 0.00~199.9 ppt
	Temp.	PT-1000: -30.0~200.0°C, NTC-30K: -30.0~130.0°C
	Concentration	<p>(Each range includes different temperature conditions)</p> <p>NaCl_28% : 0-28 % HCl_18% : 0-18 % HCl_39% : 22-39 % HNO₃_30% : 0-30 % HNO₃_96% : 35-96 % NaOH_24% : 0-24 % NaOH_50% : 15-50 % H₂SO₄_37% : 0-37 % H₂SO₄_88% : 28-88 % H₂SO₄_99% : 89-99 % H₃PO₄_35% : 0-35 %</p> <p>The boundary value of conc. conversion range of each solution can vary with changes of temp., if you go over range, there an alarm flashes on the display screen.</p> <p>Self-defined table (up to 9 temp. data, and there are 9 corresponding points for cond. v.s. conc. at each temp.)(9 x 9 matrix)</p>
Resolution	Conductivity	0.1 μ S/cm, 0.001 mS/cm, 0.01 mS/cm, 0.1 mS/cm, 1 mS/cm
	Temp.	0.1°C
	Concentration	0.01%
Accuracy	Conductivity	≥ 1 mS/cm: $\pm 1\%$ (± 1 Digit) ; < 1 mS/cm: ± 10 μ S/cm
	Temp.	$\pm 0.2^\circ\text{C}$ (± 1 Digit) with temperature error correction function
Temperature Compensation		Automatic with PT-1000 / NTC-30K
		Manual adjustment temp. compensation, and can display non-compensated conductivity value
Calibration mode		(1) Manual cell constant adjustment (2) Conductivity standard solution calibration (3) Zero-point calibration

Product Adjustment	Factor: 0.7000~1.3000	
Ambient Temp.	0~50 °C	
Storage Temp.	-20~70 °C	
Cell Constant	freely selectable 0.008~9.9999 cm ⁻¹	
Temperature Coefficient	Linear temperature compensation from (0.00%~ 40.00%), Non-Linear compensation, or Off-compensation	
Compensated Temperature	Freely set reference temperature: 0~200°C	
Display Screen	Large LCM with sensitization sensor for auto/manual illumination function and contract function	
Display	Text mode: Numerical display	
	Chart mode: 3 min. real-time dynamic graph (Conductivity and Concentration only)	
	Trace mode: Set up from 3 min. to four weeks duration of the measured value trend graph (Conductivity and Concentration only)	
Analog output	Isolated DC 0/4~20mA corresponding to main measurement, max. load 500Ω	
Logbook	50 event records	
Serial interface	Isolated RS-485(MODBUS RTU or ASCII)	
Modbus communication	Measuring value, calibration data, product adjustment, event logbook, parameter readout or selection	
Settings	Contact	RELAY contact, 240VAC 0.5A Max.(recommended)
	Activate	Hi/Lo. Hi/Hi. Lo/Lo selectable two limited programmable, ON/OFF
Wash	RELAY contact ON 0~99min. 59sec. / OFF 0~999hr 59min.	
Protection	IP65 (NEMA 4X)	
Power Supply	100V~240VAC±10%, 7W max., 50/60Hz	
Installation	Wall or Pipe or Panel Mounting	
Dimensions	96m × 96mm × 132mm (H×W×D)	
Cut off Dimensions	93 mm × 93 mm (H×W)	
Weight	0.5Kg	

Note: The specifications are subject to change without notice.

1.2 Measurement principle

1. EX2000RS utilizes electromagnetic conversion to measure the conductivity of a sample. The sensor is inductive, composed of a drive coil and a receive coil that are not in direct contact with the solution. The material used for the sensor is chemically resistant, and is applicable for acidic, alkaline, salt, effluent, etc. industrial online monitoring environments.
2. EX2000RS applies alternative signals of electric field to activate the drive coil to produce a magnetic field. The sampling solution (containing ions of varying conc.) turns into a conductive circuit which transmits the signal to the receive coil, and is turned into a current that is measureable as conductivity.
3. The EX2000RS requires the TCS3020 sensor that includes type PTC1000 temperature sensor. Users are able to select the reference during sensor assembly. “Cond.@tx” represents conductivity measured at the actual temperature “tx” and is referred to as absolute conductivity. When using temperature compensation modes (linear, non-linear, or off) and reference temperature, “Cond.@tx” represents conductivity that has been compensated in accordance to the set reference temperature.
4. EX2000RS is capable of measuring salinity and has a built-in conductivity and concentration conversion function for NaCl, HCl, HNO₃, H₂SO₄, H₃PO₄, etc. Users can select the solution type and its corresponding concentration range. When no concentration range is applicable, an error message will flash as a notice during measurement. The measured absolute conductivity “Cond.@tx” can be converted to solution concentration and defined reference temperature compensated conductivity value (Cond.@tref).
5. EX2000RS has a user-defined conductivity and concentration conversion table. The units: %, ppm, and ppt are also selectable for displaying the concentration value.
6. The user-defined concentration table(max. 9 temperature data, and 9 corresponding cond. and conc. at each temp.) allows input of absolute conductivity values and their corresponding concentration values under one temperature setting. Users may input up to 9 temperature settings with 9 pairs of conductivity and concentration values per setting (9x9 matrix). Each successive temperature, conductivity, and concentration values must be entered in increasing or decreasing order; incorrectly ordered values will be identified and

displayed. When data sets of only one temperature setting are available, linear temperature compensation must be applied to the temperature compensation value.

7. Solution conductivity is measured by electromagnetic induction, not by contact; this allows the cell constant to demonstrate the geometric structure characteristics of a drive coil and receive coil. The sensor signals may be affected by multiple factors of the installation site, including but not limited to: installation pipeline wall effect, metal (conductive) pipeline and plastic (insulation, non-conductive) pipeline, distance from sensor assembly, and pipeline shell. Following installation, zero-point calibration in the air and cell-constant calibration are mandatory.
8. ***Following installation or repair, zero-point calibration in the air is mandatory.*** The surface of the sensor should be cleaned with cleaning solution to remove all residues and kept dry for cell constant or sample calibration.
9. Selectable conductivity display formats with ranges: 2,000mS/cm, 999.9mS/cm, 99.99mS/cm, 9.999mS/cm, 999.9 μ S/cm, and AUTO (Automatic Switch Unit); 2,000mS is set as default.
10. MODBUS transmits measurement value, calibration data, sample adjustment, event log, control parameter, primary measurement selection, parameter output, and meter settings. It is also allowed to change setting via Modbus from a PLC.

Thank you for choosing the Sensorex EX2000RS toroidal conductivity transmitter/controller. In order to continually improve and enhance the transmitter's function, Sensorex reserves the right to modify the content and icon display of the product at any time and without notice. This operation manual is only provided for function and installation description, Sensorex is not liable for any person or entity for any direct or indirect loss or damage due to improper usage of this product. If you have any questions, do not understand any of the instructions or find any omissions, or errors in this operation manual, please contact Sensorex.

Precautions for installation

Wrong wiring will lead to breakdown or electrical shock of the instrument, please read and adhere to all instructions prior to installing, operating, and servicing the product.

- Educate your personnel in the proper installation operation and maintenance of the product.
- Use only qualified personnel to install, operate and maintain the product.
- Make sure to remove AC power from the transmitter before wiring input, output connections.
- Install the EX2000RS in a well ventilated area and avoid direct sunlight.
- Avoid electrical surges when using power. Especially when using three-phase power. Use ground wire correctly. If the power surges interference occurs, separate the power supply of transmitter from the control device, such as: Pumps, mixers, etc.
- To prevent electrical shock and personal injury, wear appropriate protective clothing, proper gloves and safety goggles when performing maintenance.
- Avoid touching exposed circuits and components to prevent potential shock.
- The internal relay contact of the instruments is for alarm or control function. For safety purposes, **please connect to external relays which can stand enough ampere to make sure the safety operation of the instrument.** (Please refer to chapter 3.6 "Illustration of electrical connection")

Assembly and installation

2.1 Transmitter installation:

The transmitter can be installed by panel mounting, or wall mounting.

Installation of panel mounting:

First, prepare a square hole measuring 3.66"(93mm) x 3.66" (93mm) on the panel box. Insert the controller directly into the panel box. Install the mounting brackets from the rear of the transmitter into the mounting groove.

2.2 Illustration of panel mounting

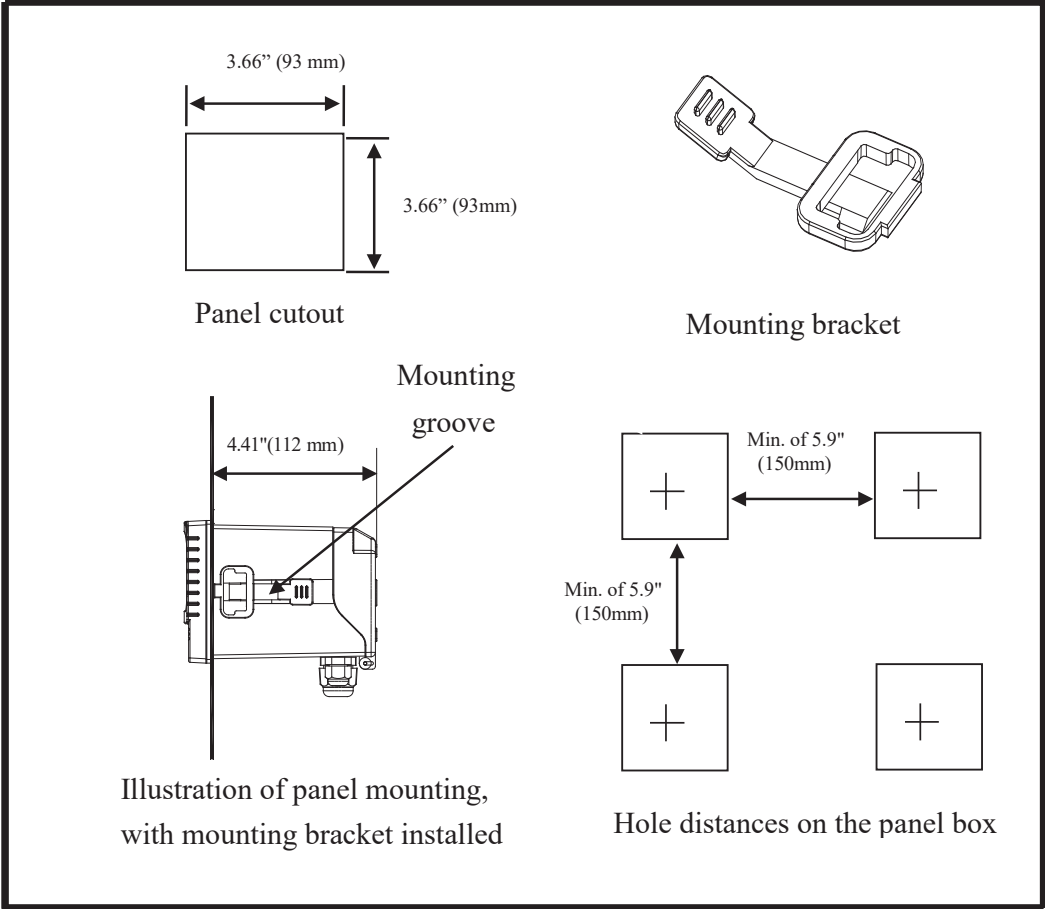

2.3 Illustration of EX2000RS wall mounting

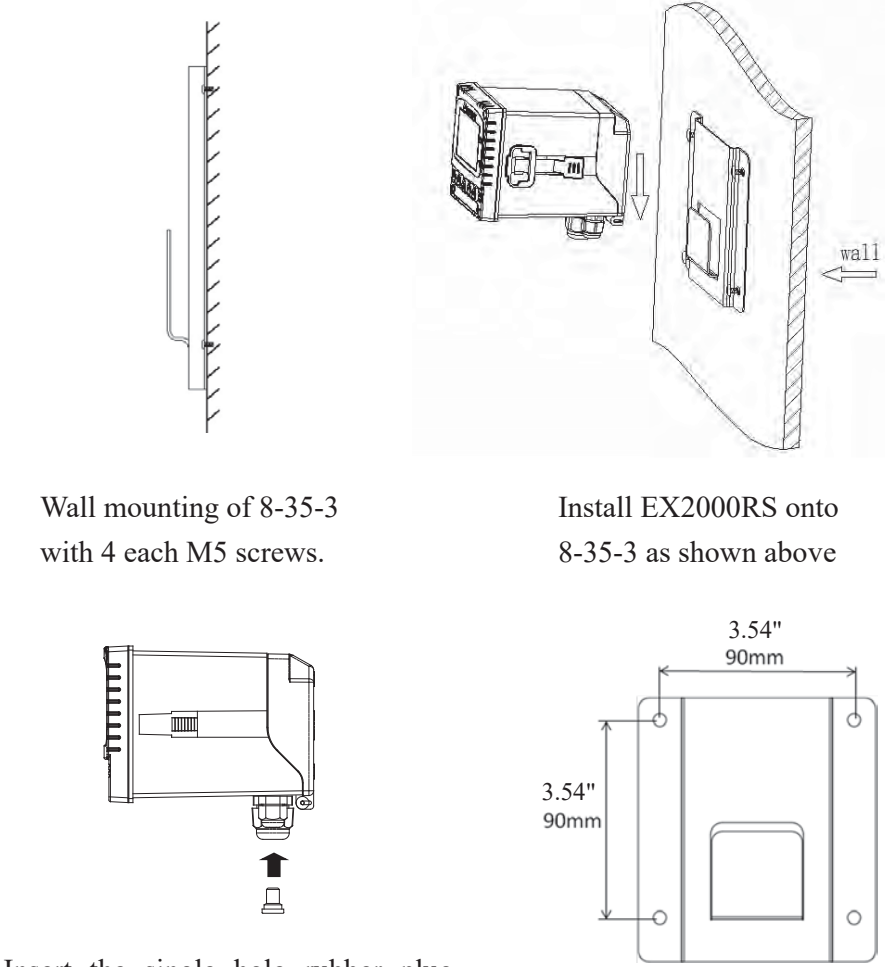

Wall mounting of 8-35-3 with 4 each M5 screws.

Install EX2000RS onto 8-35-3 as shown above

Insert the single hole rubber plug into the unused cable gland, and tighten up the cable gland to prevent the penetration of water vapor.

Drawing of wall mounting bracket
Part No. 8-35-3

3. Overview of Toroidal Conductivity transmitter EX2000RS

3.1 Illustration of rear panel

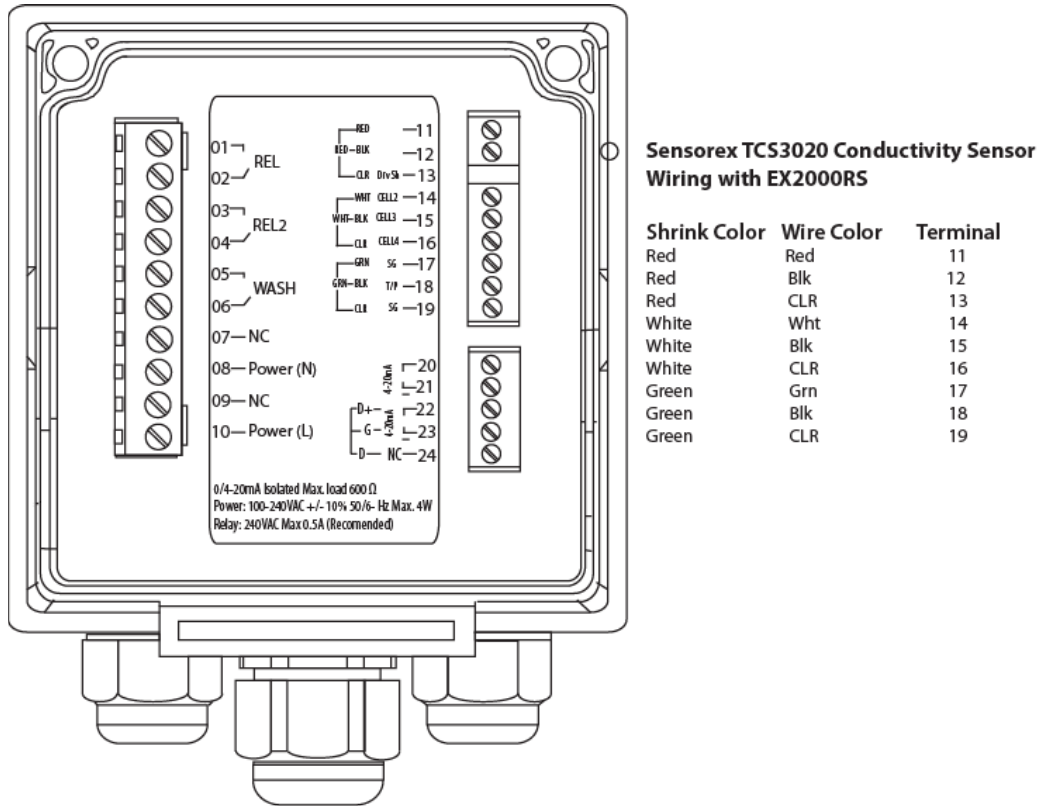

3.2 Illustration of terminal function

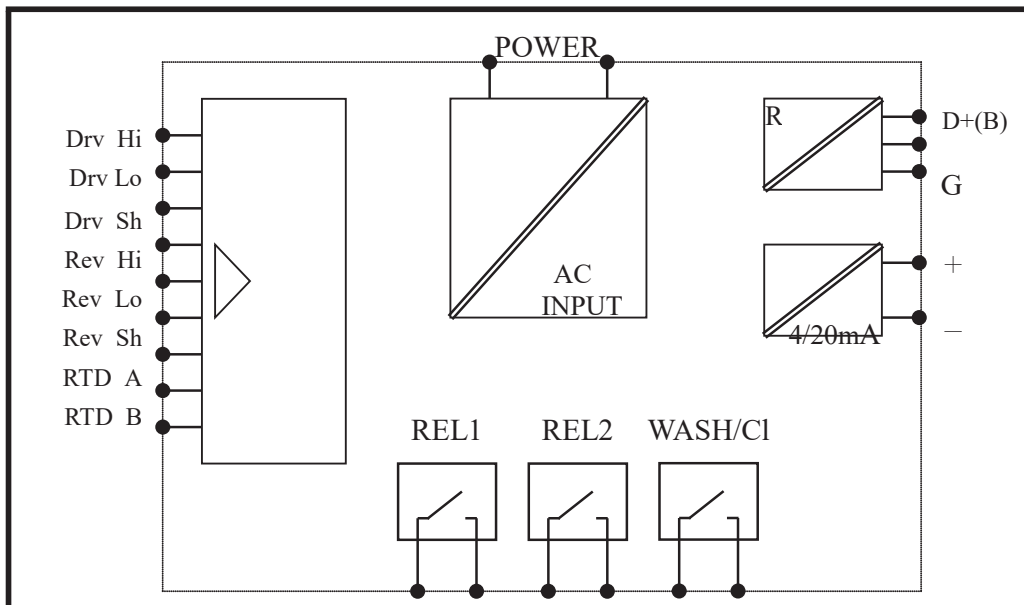

3.3 Description of terminal function

0 1	┌───┐ └───┘	REL1: First alarm control, the contact for an external relay
0 2		
0 3	┌───┐ └───┘	REL2: Second alarm control, the contact for an external relay
0 4		
0 5	┌───┐ └───┘	WASH: Wash relay contact for an external relay
0 6		
0 7	_____	NC: None contact
0 8	_____	Power(N): 100~240VAC Power supply terminal
0 9	_____	NC: None contact
1 0	_____	Power(L) : 100~240VAC Power supply terminal
1 1	_____	Drv Hi: Sensor drive coil terminal, High
1 2	_____	Drv Lo: Sensor drive coil terminal, Low
1 3	_____	Drv Sh: Sensor drive coil terminal, Shield
1 4	_____	Rev Hi: Sensor receive coil terminal, High
1 5	_____	Rev Lo: Sensor receive coil terminal, Low
1 6	_____	Rev Sh: Sensor receive coil terminal, Shield
1 7	_____	RTD A: Temperature probe terminal A
1 8	_____	RTD B: Temperature probe terminal B
1 9	_____	RTD Sh: Temperature probe terminal Shield (place jumper wire from 18 to 19)
2 0	_____	4~20mA +terminal: Master measure current output terminal +, for an external recorder or PLC control
2 1	_____	4~20mA - terminal: Master measure current output terminal -, for an external recorder or PLC control
2 2	_____	D+(B): RS-485 output D+(B)
2 3	_____	G: RS-485 output GND
2 4	_____	D-(A): RS-485 output D-(A)

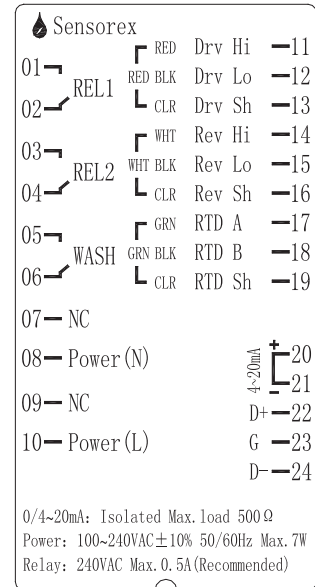

3.4 TCS3020 sensor cable connections

Terminal ID/#	Color of heat shrink tube	Wire color	Wire descriptions
Drv Hi/11	Red	Red	Drive Hi
Drv Lo/12		Red-Black	Drive Lo
Drv Sh/13		Clear	Drive Shield
Rev Hi/14	White	White	Receive Hi
Rev Lo/15		White-Black	Receive Lo
Rev Sh/16		Clear	Receive Shield
RTD A/17	Green	Green	RTD A
RTD B/18		Green-Black	RTD B
RTD Sh/19		Clear	RTD Shield

Note: place jumper wire from 18 to 19

3.5 Illustration of electrical connection

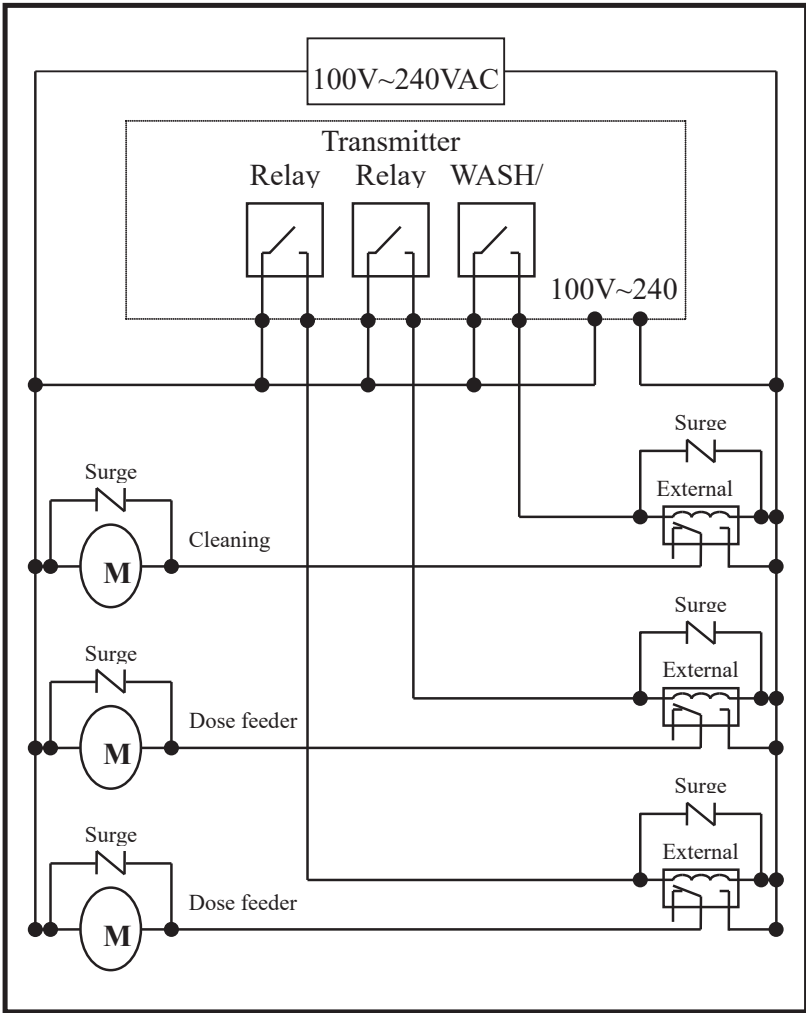

Note: The transmitter's built-in miniature relays should only be repaired/replaced by professional technicians. It is recommended to use an external relay (Power Relay) to activate the external equipment.



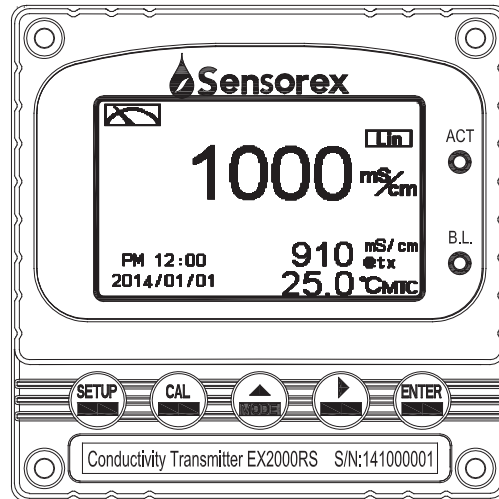

4. Configuration

4.1 Illustration of front panel



4.2 Keypad

Description of the key functions is in the following:

-  : In the parameter set-up mode, pressing this key allows you to exit parameter set-up mode and return to Measurement mode.
-  : In the Calibration mode, pressing this key allows you to exit Calibration mode and return to Measurement mode.
-  :
 1. In the parameter set-up mode and Calibration mode, pressing this key selects leftward or change to another page.
 2. When adjusting value, press this key to increase the value.
-  :
 1. In the parameter set-up mode and Calibration mode, press this key to select rightward or change to another page.
 2. When adjusting value, press this key to decrease the value.
-  : Key for confirmation; pressing this key is essential when modifying data value or selecting the parameter setting items in the window.

4.3 LED indicators:

ACT : Washing operation relay(Clean) and dosing operation relay (Relay 1, Relay 2) indicator



B.L. : **BackLight** sensor; in the automatic display backlit mode, the lamp will light up or go out as the change of environmental brightness.

5. Operation



5.1 Measurement mode:

After all electrical connections are finished and tested, connect the instrument to the power supply and turn it on. The transmitter will automatically enter measurement mode with the factory default settings or the last settings from user.





5.2 Set-up menu:

Please refer to the set-up instructions in Chapter 7. Press  and  simultaneously to enter into set-up menu, and press  to go back to measurement mode.

5.3 Calibration menu:

Please refer to the calibration instructions in Chapter 8. Press  and  simultaneously to enter into calibration menu, and press  to go back to measurement mode.

5.4 Shortcuts:

1. In the measurement mode, if selecting MTC for temperature compensation mode, you may press  and  to adjust MTC temperature value.
2. Under measurement mode, press  continuously for 2 seconds to see the Logbook function directly. Press  key to back to measurement mode.
3. Under measurement mode, press  continuously for 2 seconds to switch the display mode from text mode, trace mode, and real-time chart display mode.

5.5 Default value:

5.5.1 Setting default value:

Measurement mode: Conductivity@tref

Range: 2,000mS

Temperature compensation: PT-1000

Temperature Coefficient: Lin, 2.00%

Relay 1: High point alarm: AUTO, SP1= 1,000 mS/cm, Hys.=10mS/cm

Relay 2: Low point alarm: AUTO, SP2 =100 mS/cm, Hys.= 1.0 mS/cm

Wash time: OFF

Analog current output (Conductivity): 4~20 mA, 0~1,000mS/cm

RS-485: MODBUS RTU, 19200, EVEN, 1, ID: 1

Digital filter: 0 (0 means Auto setting according to range)

Backlight setting: Off

Contrast: 0

Code set-up: Off

Auto back: Auto, 3 minutes

6. Measurement display mode

6.1 Text mode

This is normal mode for digit display, as shown in the following illustration. It mainly includes main measurement value and units, temperature measurement value and units, temperature compensation mode, and clock display.

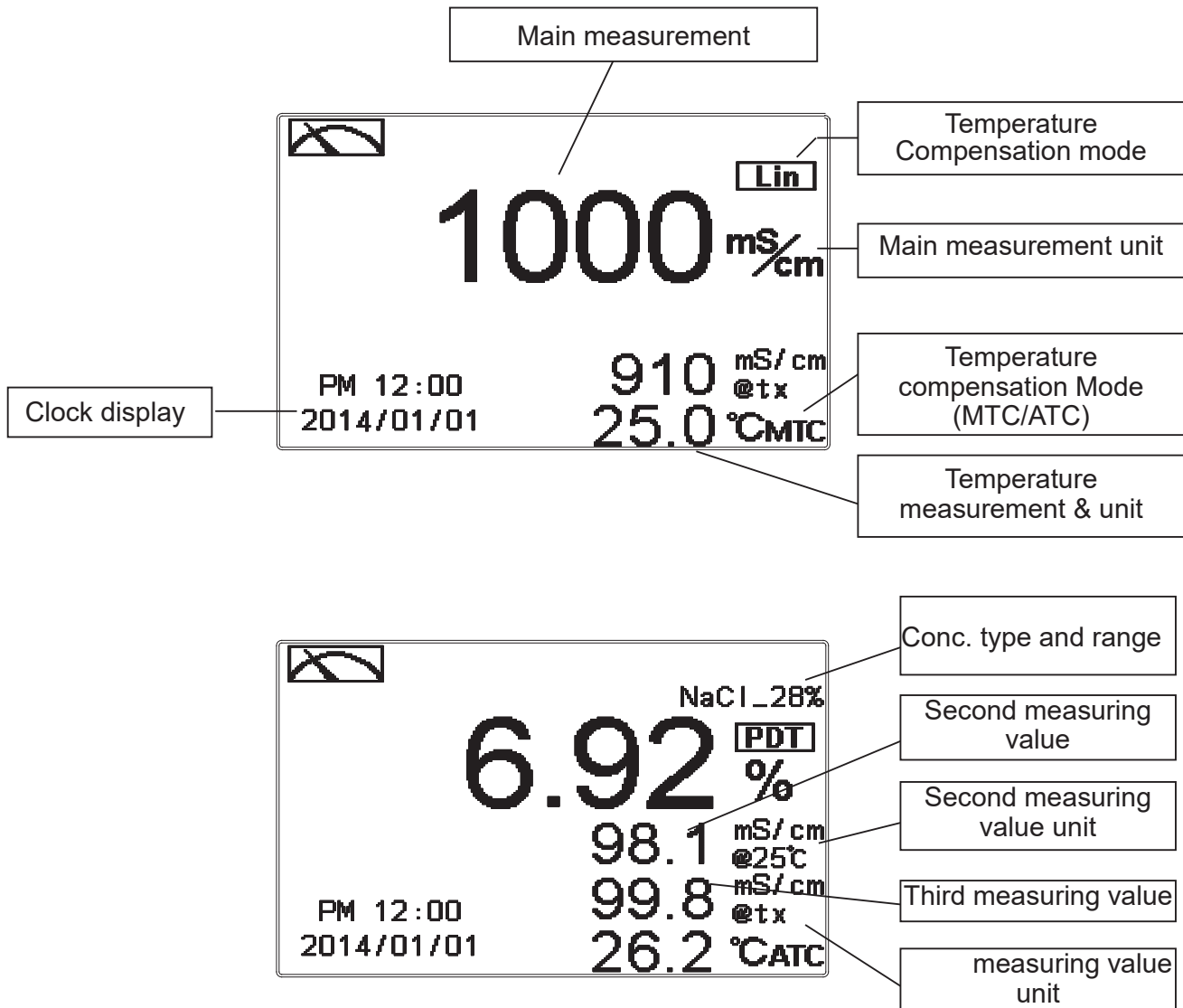

The first line is main measurement corresponding to desired parameter, and the second and the third lines are auxiliary ones to show related values but not necessary parameters. The fourth line is to show temperature reading.

6.2 Real-Time Chart mode

Real-time chart mode is for dynamic display of real-time graphics. The duration is about three minutes of the recent changes in measured values of the curve. Users can set the mode to its corresponding Cond./Conc. measuring range (see section 7.4). The smaller the range is set, the higher the resolution of the display is. When entering setup or calibration mode and returning to measurement mode, the real-time graphics will be re-updated. When the measured value exceeds a set range of the upper and lower limit, the graphics will be presented in the upper and lower limits as a dotted line. Real-time chart mode display is shown below. There are also real-time measurement value, & unit, and temperature value & unit which are displayed in the bottom of the screen. The timeline in real-time graphic is divided into 12 segments, which represent of each of 1 / 4 minutes (15 seconds).

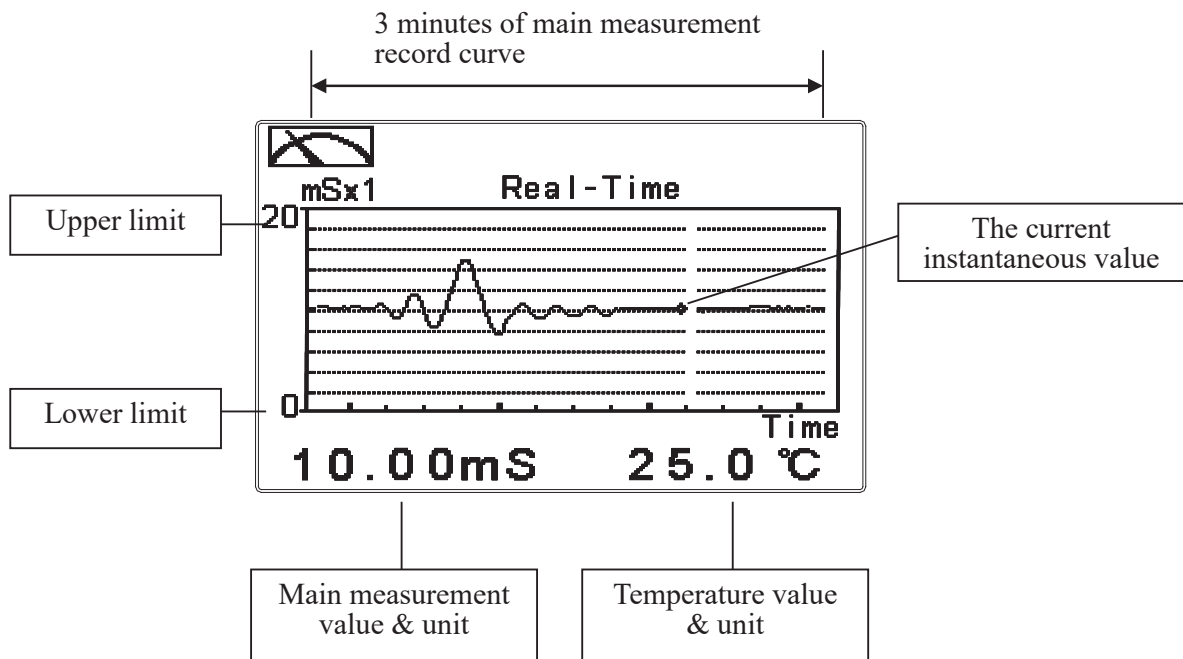

6.3 Trace mode

The feature of the trace mode is the record duration which can be set by the user (range from three minutes, up to four weeks). The trend graphic records the measurements in the past T time. The trend is recorded as a 60 data group structure. Hence, each group of units is recorded in T/60 time interval. The trend line is constructed by all value data which is calculated to the average (Mean Value), maximum (Max Value) and minimum (Min Value) form. When the latest T/60 record shows in the rightmost of the trend graphic, all the previous records will be moved to the left side of the graphic. For example, T is set to 60 hours, then each set of records will be calculated to the average, the maximum, the minimum values after one hour ($T/60 = 1$), each time interval. Timeline of trends which is divided into 12 depictions showed on the horizontal axis of the display is on behalf of each characterization interval $T/12$. So, every depiction has 5 ($T/60$) sets of records. Users can set the corresponding Cond./Conc. measuring range in its set-up menu (see section 7.4). The smaller the range is set, the higher the resolution of the display is. The trace mode is shown below. There are also real-time measurement value, & unit, and temperature value & unit which are displayed in the bottom of the screen.

Attention: When the time interval has been reset, the trend in the data will not be retained, it will start a new trace record.

Note: The time display format (XX: XX) (hr: min), for example, appear as four weeks (672:00)

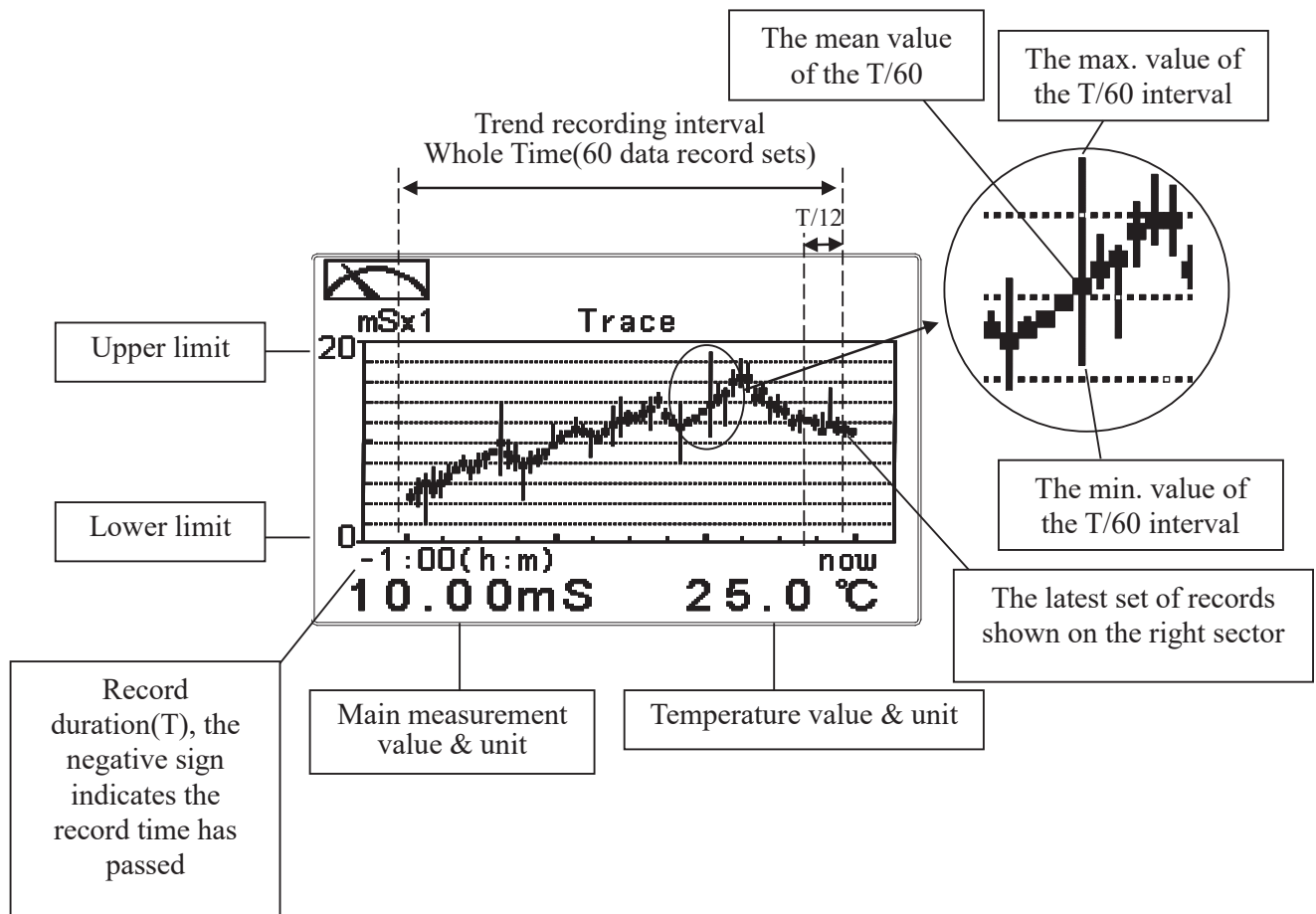

6.4 Warning symbols and text

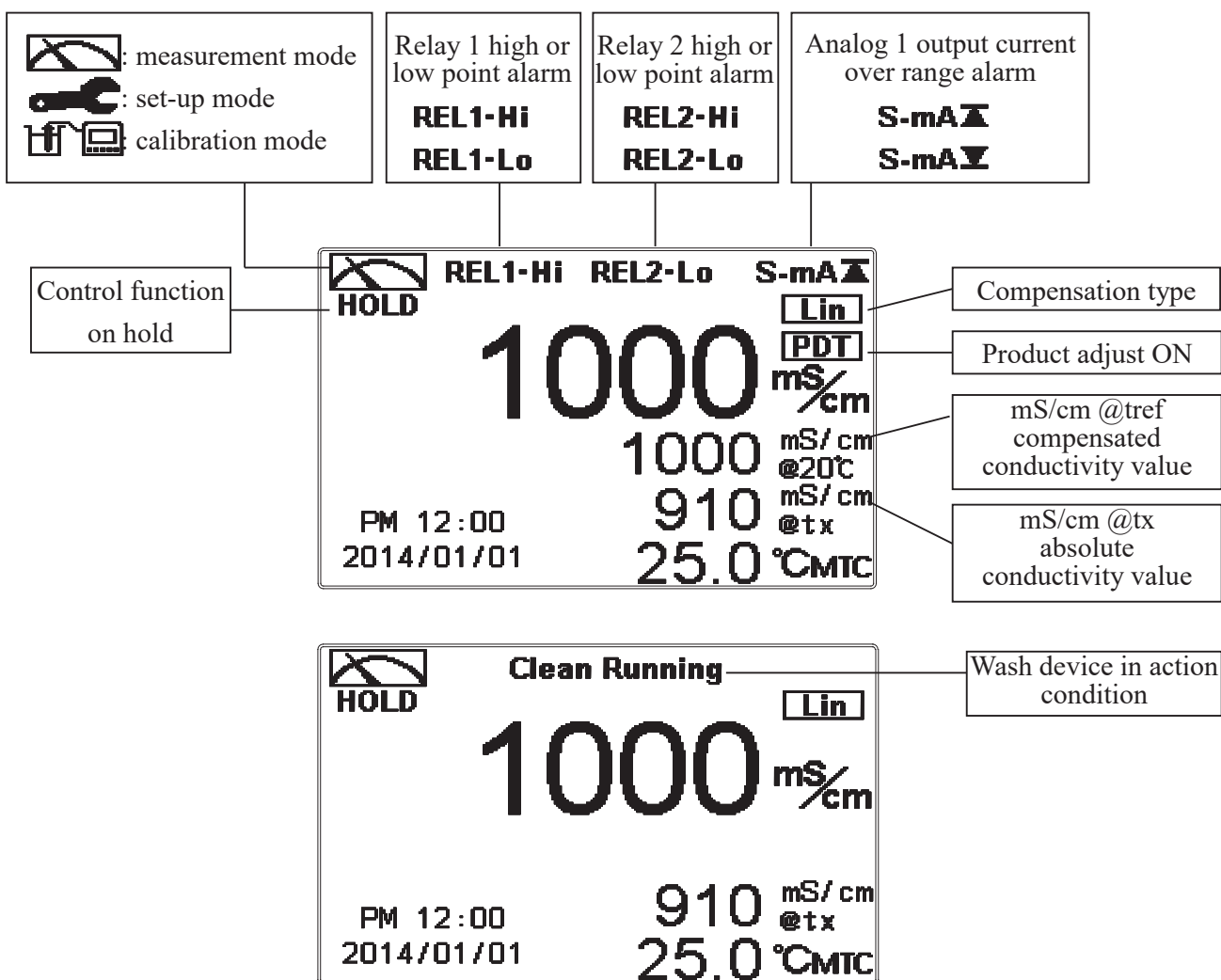

1. When the clean function is activated, the display shows and flashes the description, “Clean Running”. At the same time, the ACT indicator LED lights up, and the transmitter automatically turns off Relay 1 and Relay 2 function. After finishing cleaning, the Relay 1 and Relay 2 will automatically return to normal status.
2. When Relay 1/Relay 2 which is set in high setting point is in action, the display shows and flashes the description, “REL 1-HI/REL 2-HI”, and ACT indicator LED lights up. When Relay 1/Relay 2 which is set in low setting point is in action, the display shows and flashes the description, “REL 1-Lo/ REL 2-Lo”, and ACT indicator LED lights up.
3. When the Analog 1 current output exceeds the upper/lower limitation, the display twinkles “S-mA \uparrow mA” as an alarm ∇



Note: The “HOLD” warning text appears when clean function is activated, or when entering setup menu, or when entering calibration menu. Under HOLD status, the corresponding display and output are as follows:

1. Both Relay 1 and Relay 2 are made inactive. If enter setting menu or calibration menu under clean status, the instrument will stop clean status automatically.
2. The current output which is corresponding to measurement value remains at the last output value before HOLD status.
3. The last signal output value of RS-485 interface is kept at the last output value before HOLD status.

7.1 Entry of set-up menu

In the measurement mode, pressing the  and the  keys simultaneously allows you enter the overview of current setting, and press  to enter the set-up mode to modify the setting if necessary.

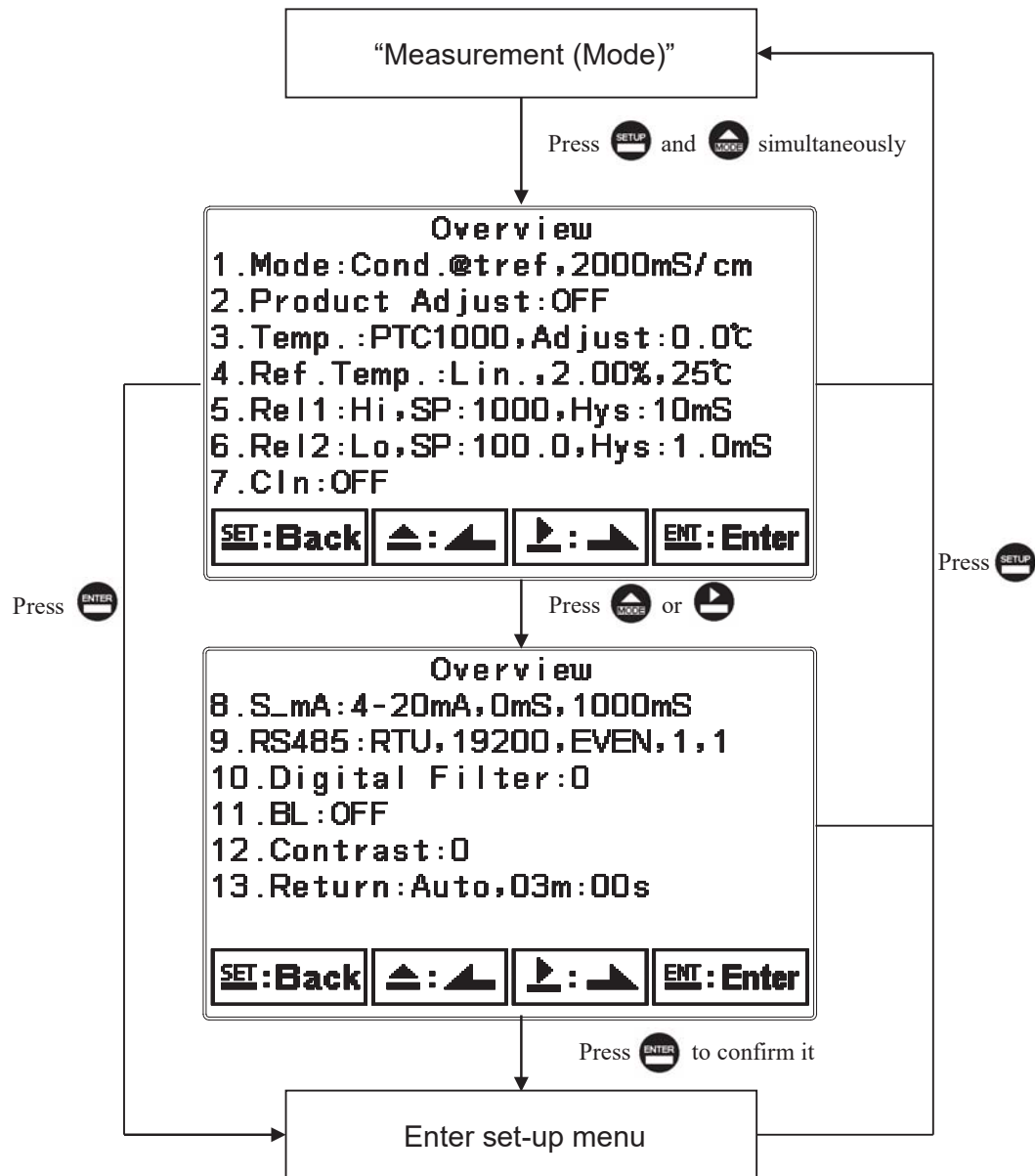

7.2 Security code of settings

After entering set-up mode, select “code” item, press  to enter into code procedure. **The code pre-setting is 1111.**

Note: The code of setting mode is prior to the code for calibration. That means that the code of setting mode can be used for the code of calibration mode.

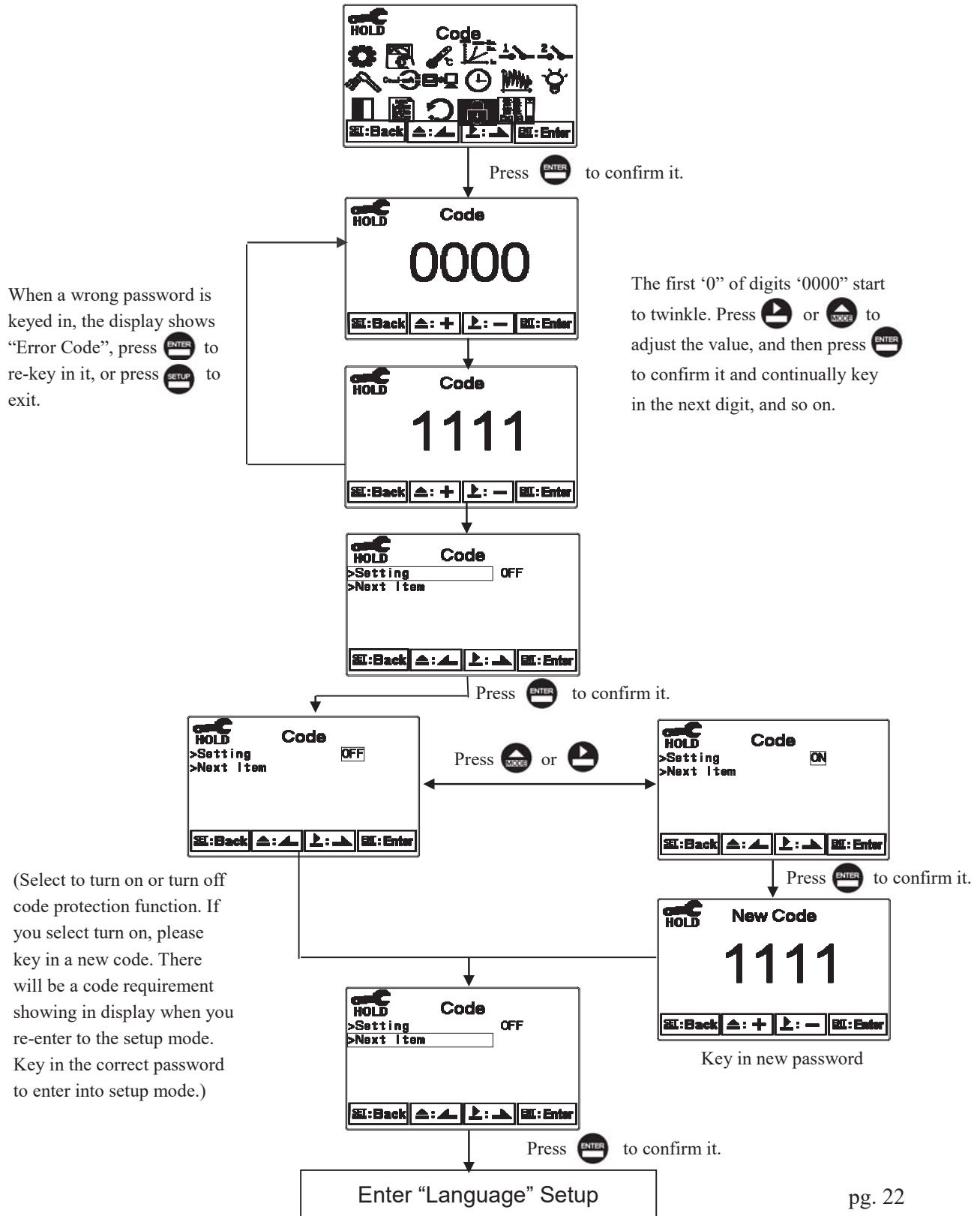

7.3 Language

Enter Language setup menu, select the system language from English, Traditional Chinese and Simplified Chinese.

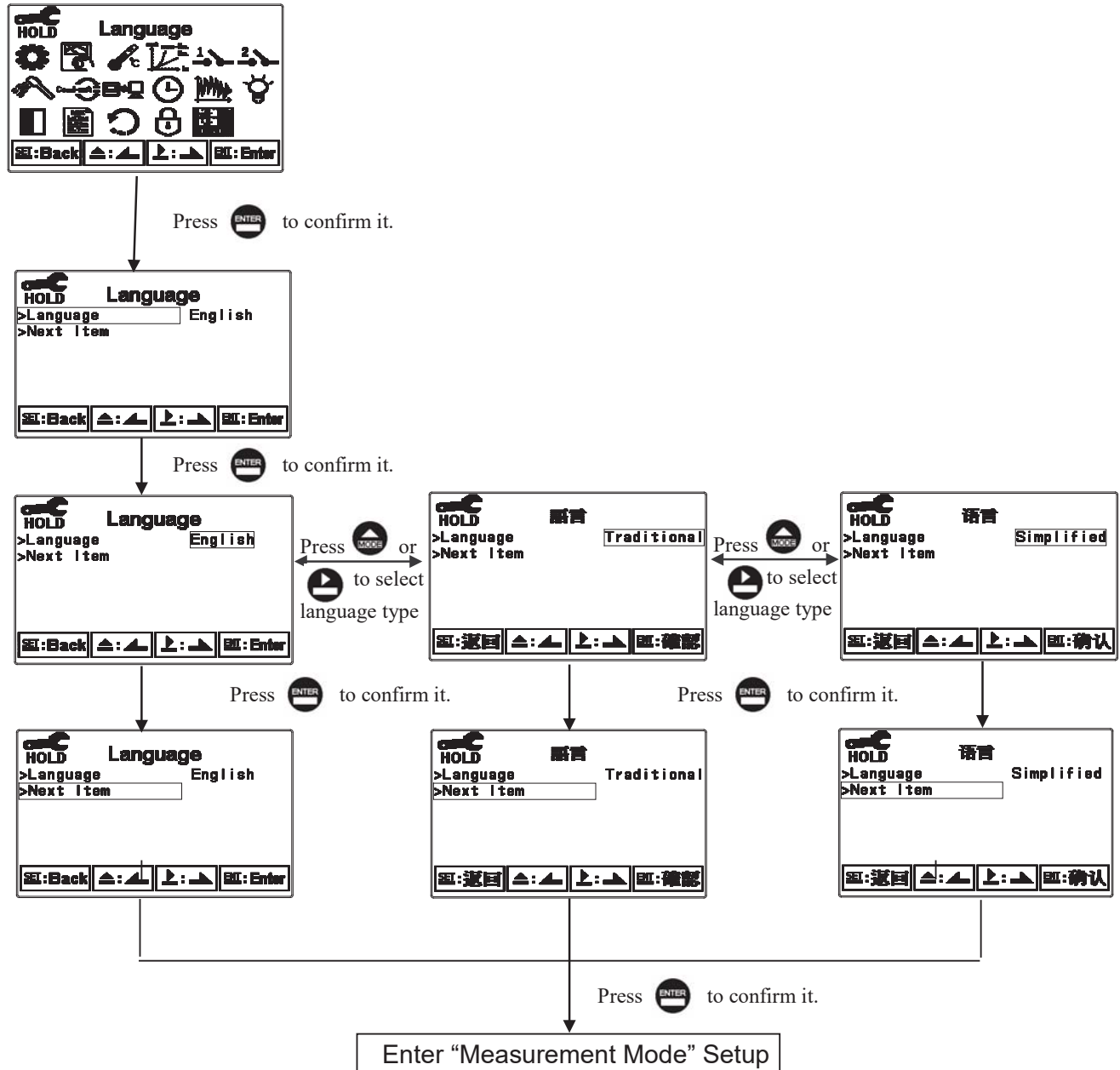

7.4 Mode

The default setting of measuring range is 2,000mS/cm, and users can select the desired range from 2,000mS/cm, 999.9mS/cm, 99.99mS/cm, 9.999mS/cm, 999.9μS/cm or AUTO range selection.

7.4.1 Conductivity with Temperature Compensation (Cond.@tref)

Conductivity with temperature compensation means that conductivity can be obtained by linear or non-linear temperature compensation setting. (“temperature compensation coefficient” and “temperature compensation reference temperature”, please refer to ch7.7 “Temperature Compensation Coefficient”.) After setup of Mode, select “Cond.@tref” and measuring range or AUTO range selection, and then select display mode.

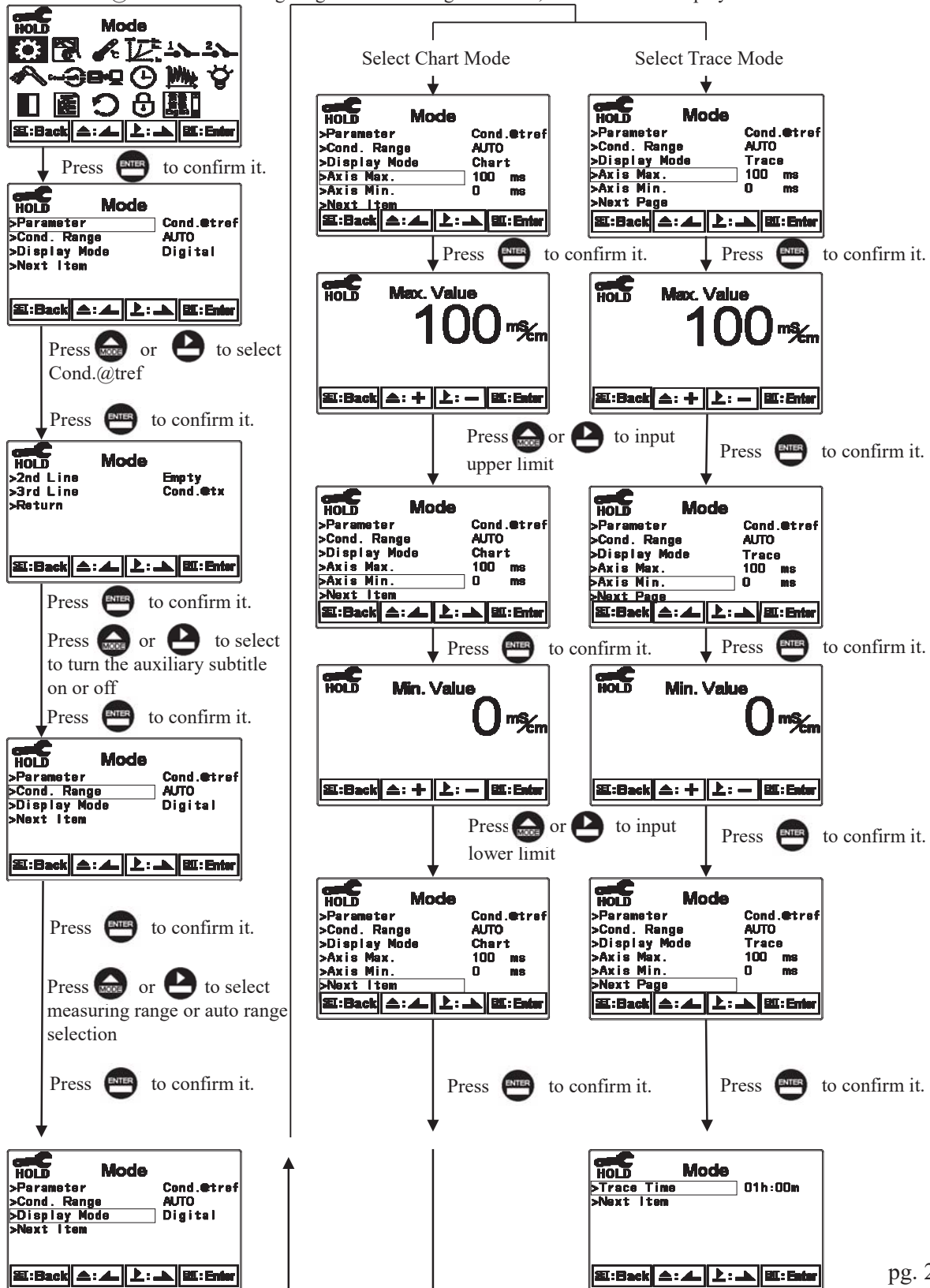

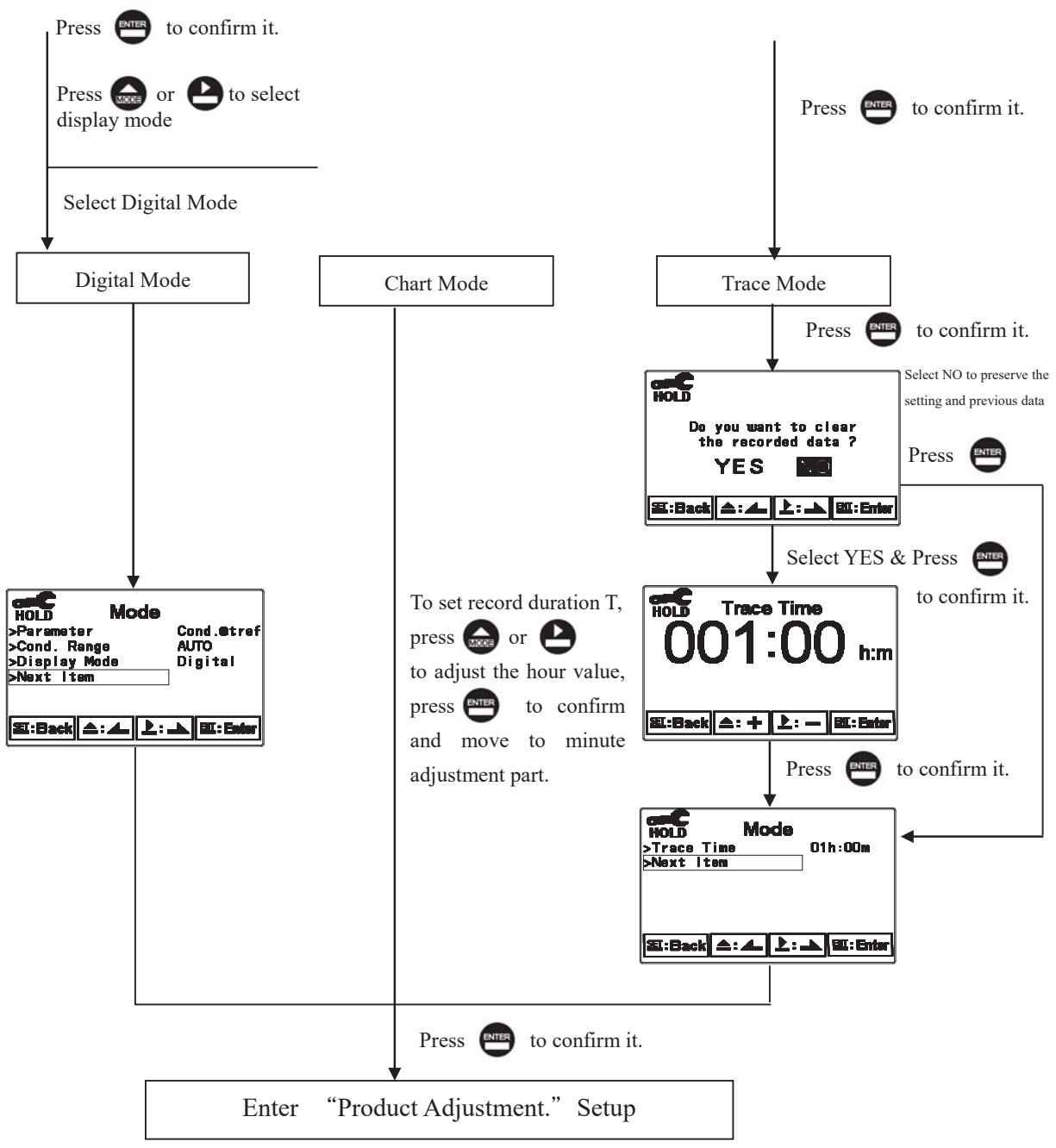

7.4.2 Absolute Conductivity(Cond.@tx)

Absolute conductivity is to present the actual conductivity without temperature compensation of a measured solution. Enter setup of Mode and select absolute conductivity "Cond.@tx". Then select the measuring range or AUTO range and display mode.

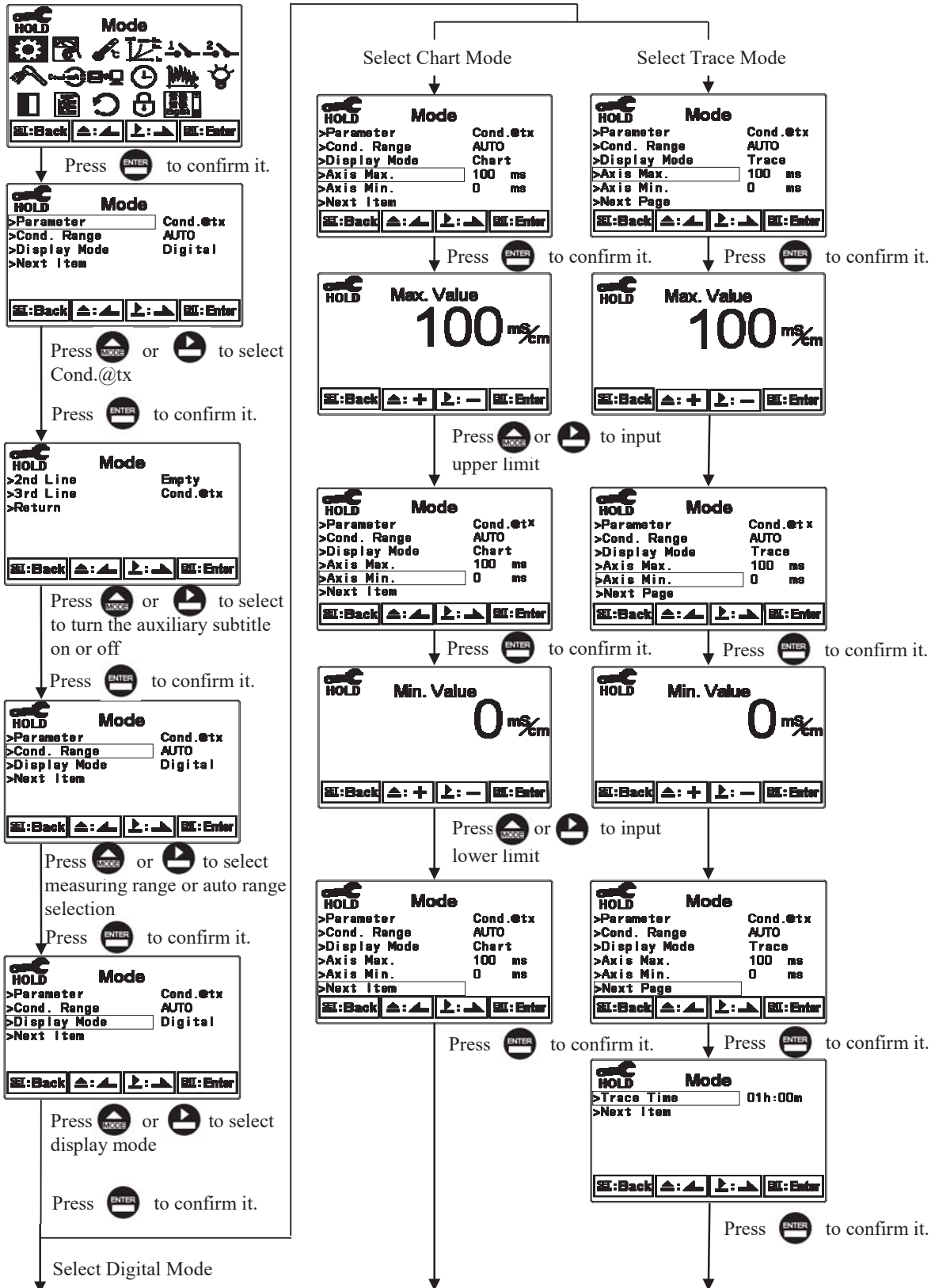

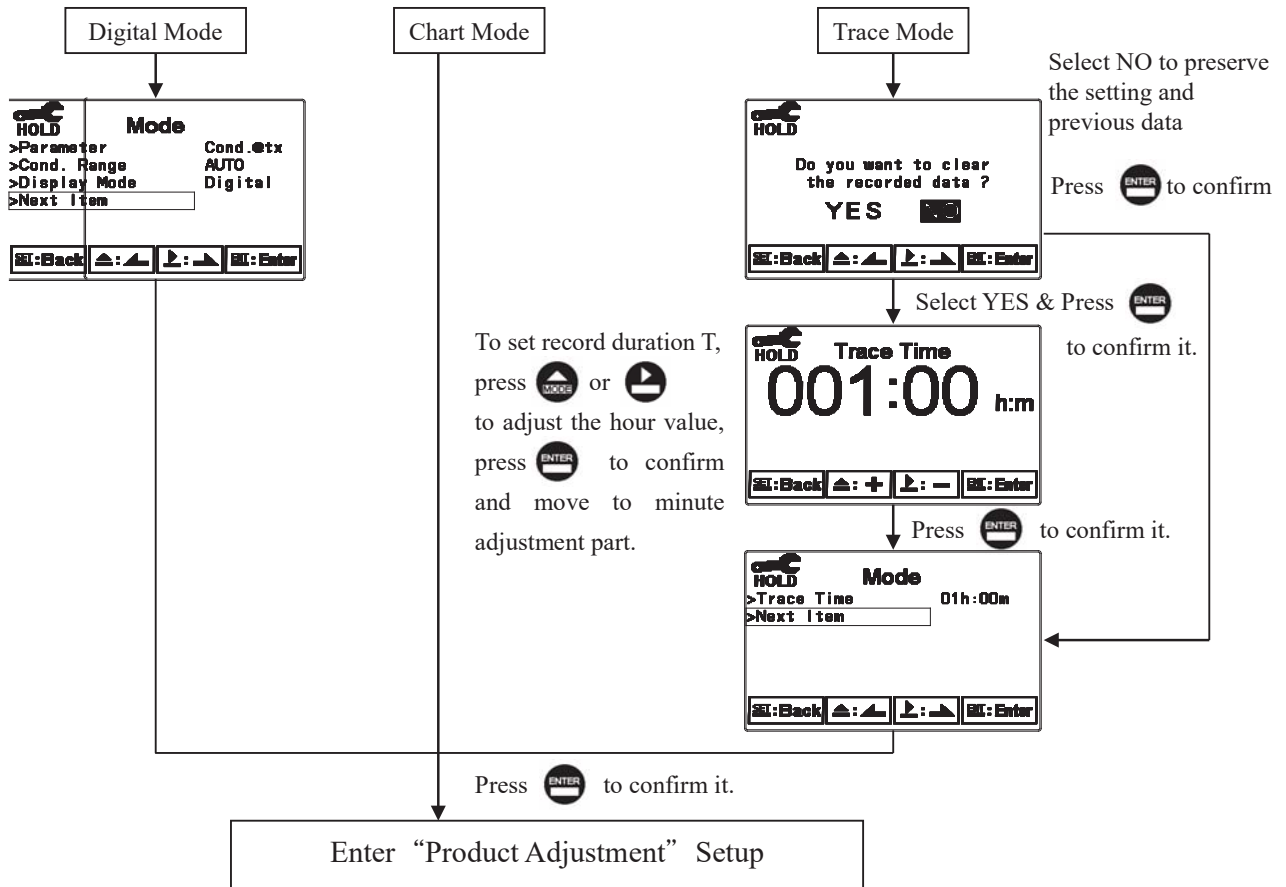

Concentration

Enter setup of Mode and select “Conc.” measuring mode, optimum measuring solution, varieties and concentration.

Built-in measuring ranges are listed below: NaCl_28%(0-28%), HCl_18%(0-18%), HCl_39%(22-39%), HNO₃_30%(0-30%), HNO₃_96%(35-96%), NaOH_24%(0-24%), NaOH_50%(15-50%), H₂SO₄_37%(0-37%), H₂SO₄_88%(28-88%), H₂SO₄_99%(89-99%), H₃PO₄_35%(0-35%) or Defined, and then select display mode.

Concentration conversion boundary values of each solution vary with the changes of temperature. As conductivity or concentration exceeds boundary limits of its measuring range, the measured value twinkling will represent an error warning, however, please note that “Defined” is without measuring range limitation and an error warning.

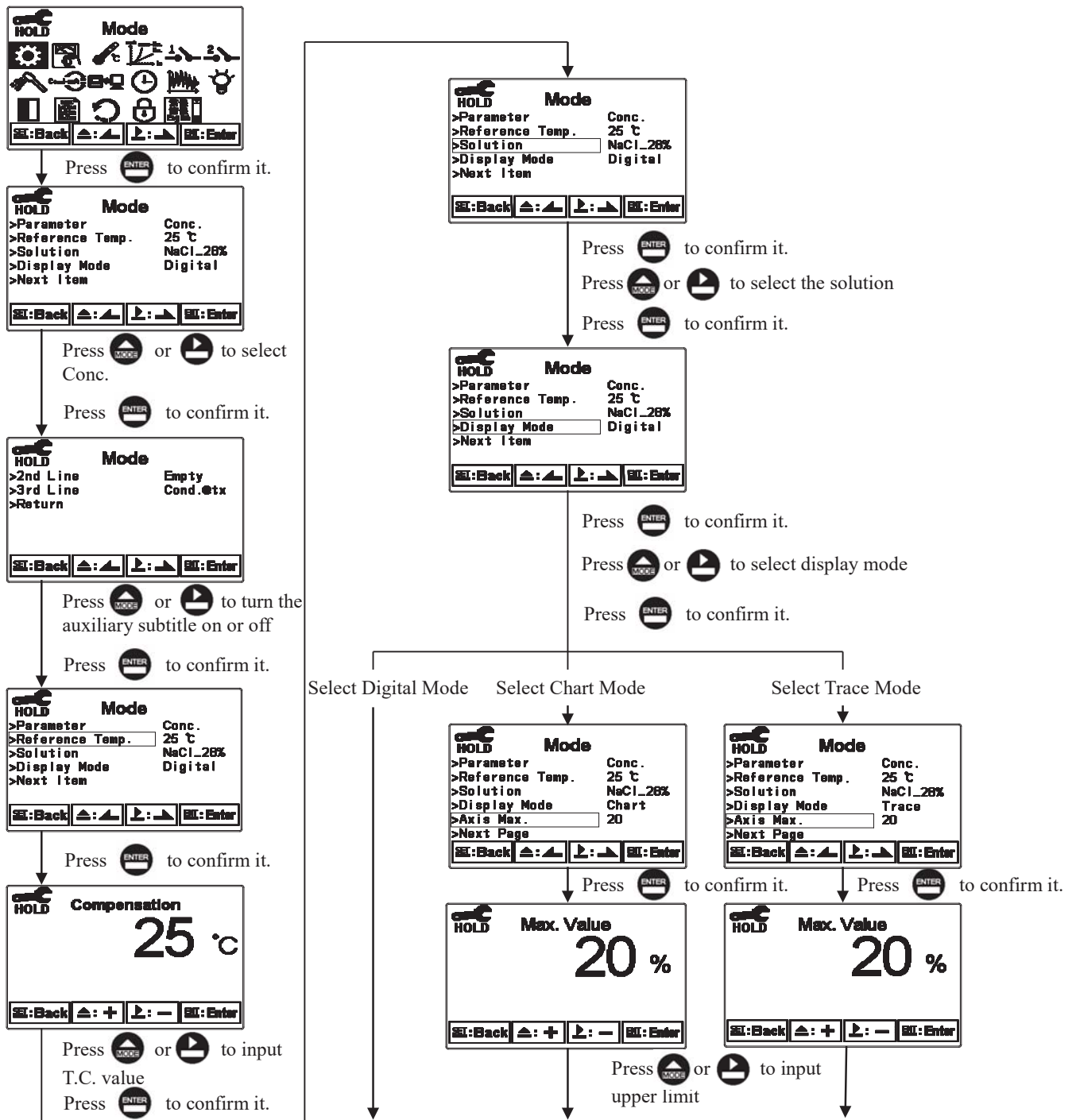

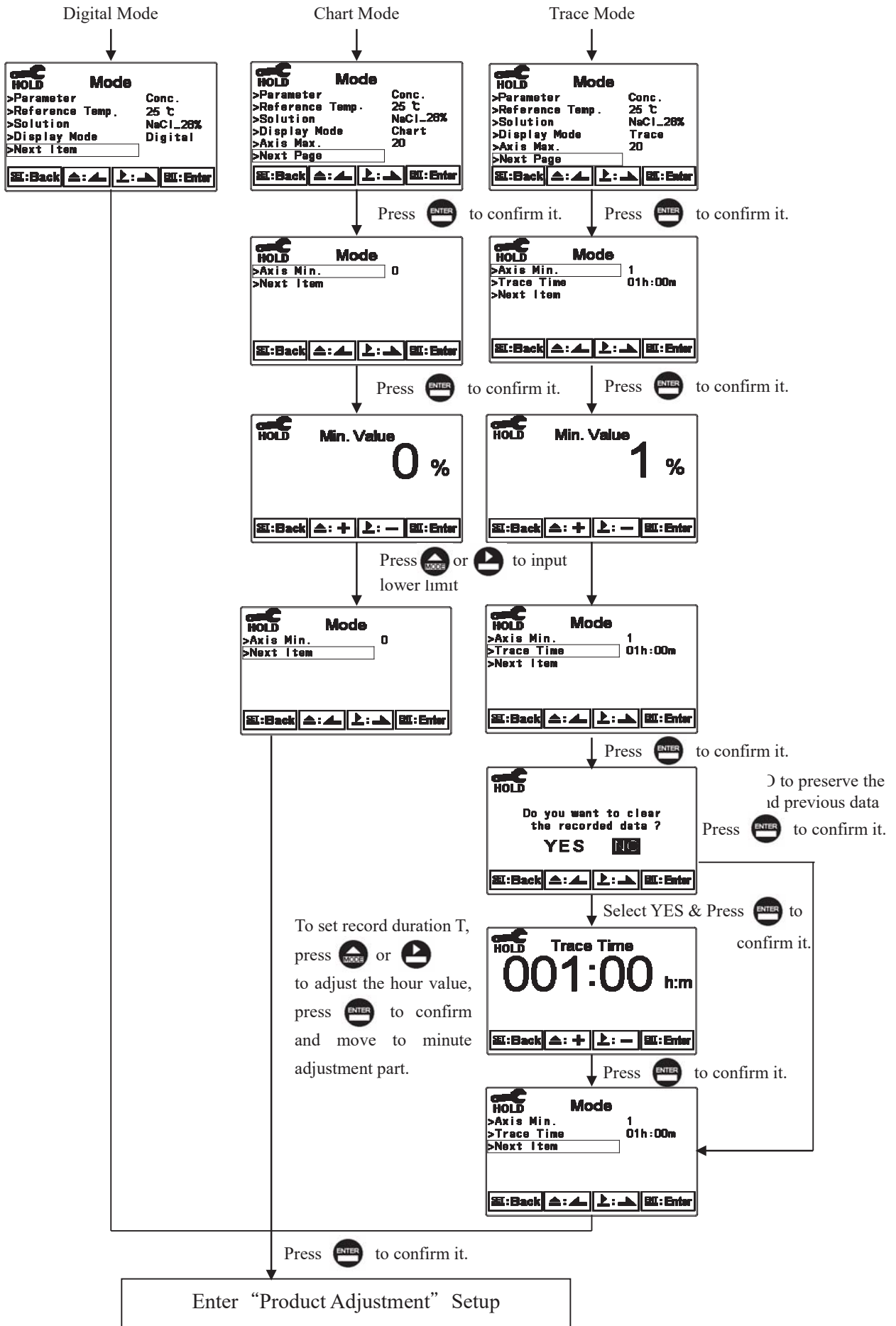

7.4.3.1 Defined concentration table

If the measured sample information is not listed in built-in table of the transmitter, users can input their defined table. Defined table can be input data with temperature of measured solution, sort ascending or sort descending, from 1~9 temperature table. At least two or up to nine conductivity and concentration conversion data are included at each temperature (more data, more approximate the solution concentration, higher conversion resolution), and each data include one concentration and its corresponding conductivity.

Conductivity or concentration needs to be input in ascending or descending order. If users' measured solution only has one data (one concentration and its corresponding conductivity), they need to set linear temperature compensation coefficient for that in order to make the temperature compensation.

Defined table default setting which includes 9 data is for Hydrofluoric Acid at 25°C. Users can revise the data, in addition, they need to input linear temperature compensation coefficient (refer to HF table); for users only with one data, after inputting corresponding value of conductivity and concentration, it also requires T.C. coefficient.

If the data are attained by two or more temperature points, there is no need to input T.C. coefficient because the unit can calculate the corresponding concentration value and conductivity with reference temperature based on conversion data in different temperature.

Once default conversion table for HF is being changed, it needs re-input again.

If the temperature, conductivity and concentration of test solution are approximate to measured solution, higher & more accurate conversion relation can be required.

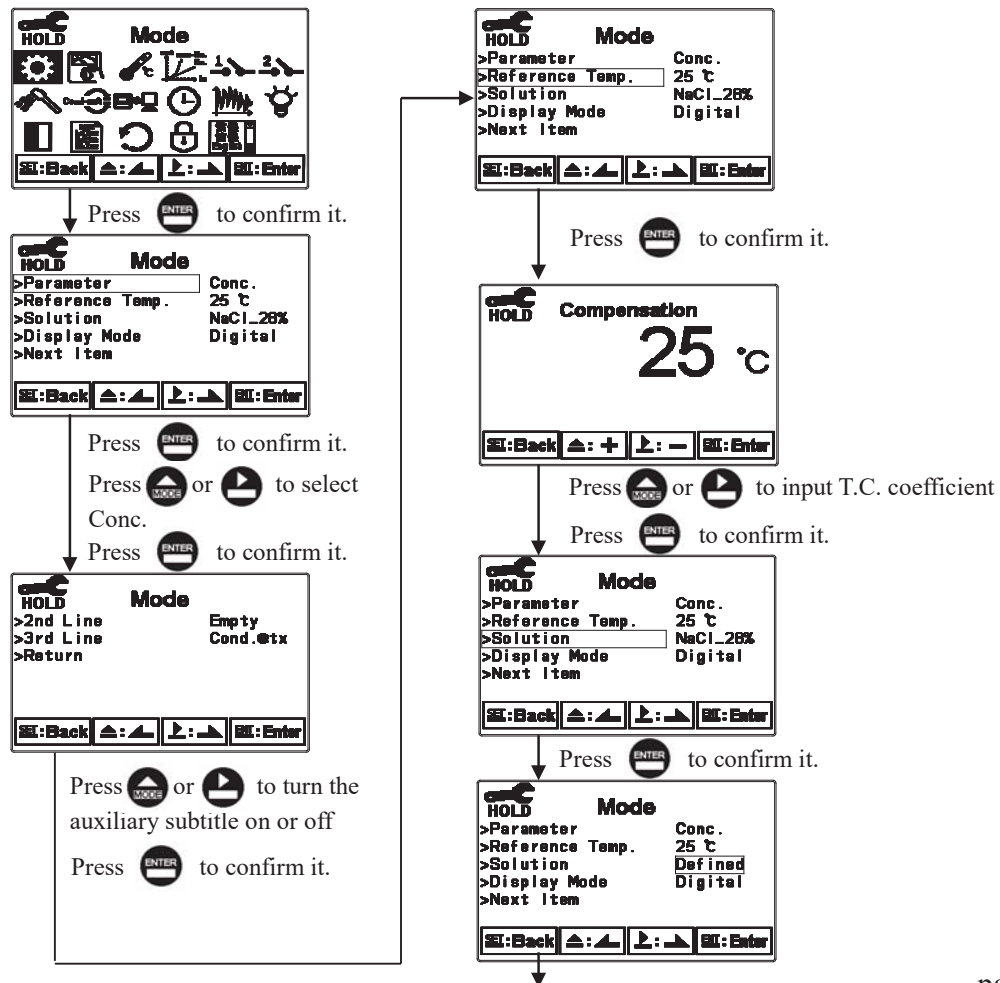

Press or to select Defined.

Press to confirm it.

```
HOLD Mode
>Temp.Point 1
>Conc.Point 9
>Unit %
>Coefficient 2.00 %
>Set Table Enter
[Left] [Up] [Down] [Right] [Enter]
```

Press to confirm it.

Press or to set desired number of tables

Press to confirm it.

one temp. point

```
HOLD Mode
>Temp.Point 1
>Conc.Point 9
>Unit %
>Coefficient 2.00 %
>Set Table Enter
[Left] [Up] [Down] [Right] [Enter]
```

two or more temp. points

```
HOLD Mode
>Temp.Point 9
>Conc.Point 9
>Unit %
>Set Table Enter
[Left] [Up] [Down] [Right] [Enter]
```

```
HOLD Mode
>Temp.Point 1
>Conc.Point 9
>Unit %
>Coefficient 2.00 %
>Set Table Enter
[Left] [Up] [Down] [Right] [Enter]
```

Press to confirm it.

Press or to set the number of Conc. points

Press to confirm it.

```
HOLD Mode
>Temp.Point 1
>Conc.Point 9
>Unit %
>Coefficient 2.00 %
>Set Table Enter
[Left] [Up] [Down] [Right] [Enter]
```

Press to confirm it.

Press or to set the unit of Conc.

Press to confirm it.

```
HOLD Mode
>Temp.Point 1
>Conc.Point 9
>Unit %
>Coefficient 2.00 %
>Set Table Enter
[Left] [Up] [Down] [Right] [Enter]
```

Press to confirm it.

Press or to set the T.C. coefficient

```
HOLD Mode
>Temp.Point 9
>Conc.Point 9
>Unit %
>Set Table Enter
[Left] [Up] [Down] [Right] [Enter]
```

Press to confirm it.

Press or to set the number of Conc. points

Press to confirm it.

```
HOLD Mode
>Temp.Point 9
>Conc.Point 9
>Unit %
>Set Table Enter
[Left] [Up] [Down] [Right] [Enter]
```

Press to confirm it.

Press or to set the unit of conc.

Press to confirm it.

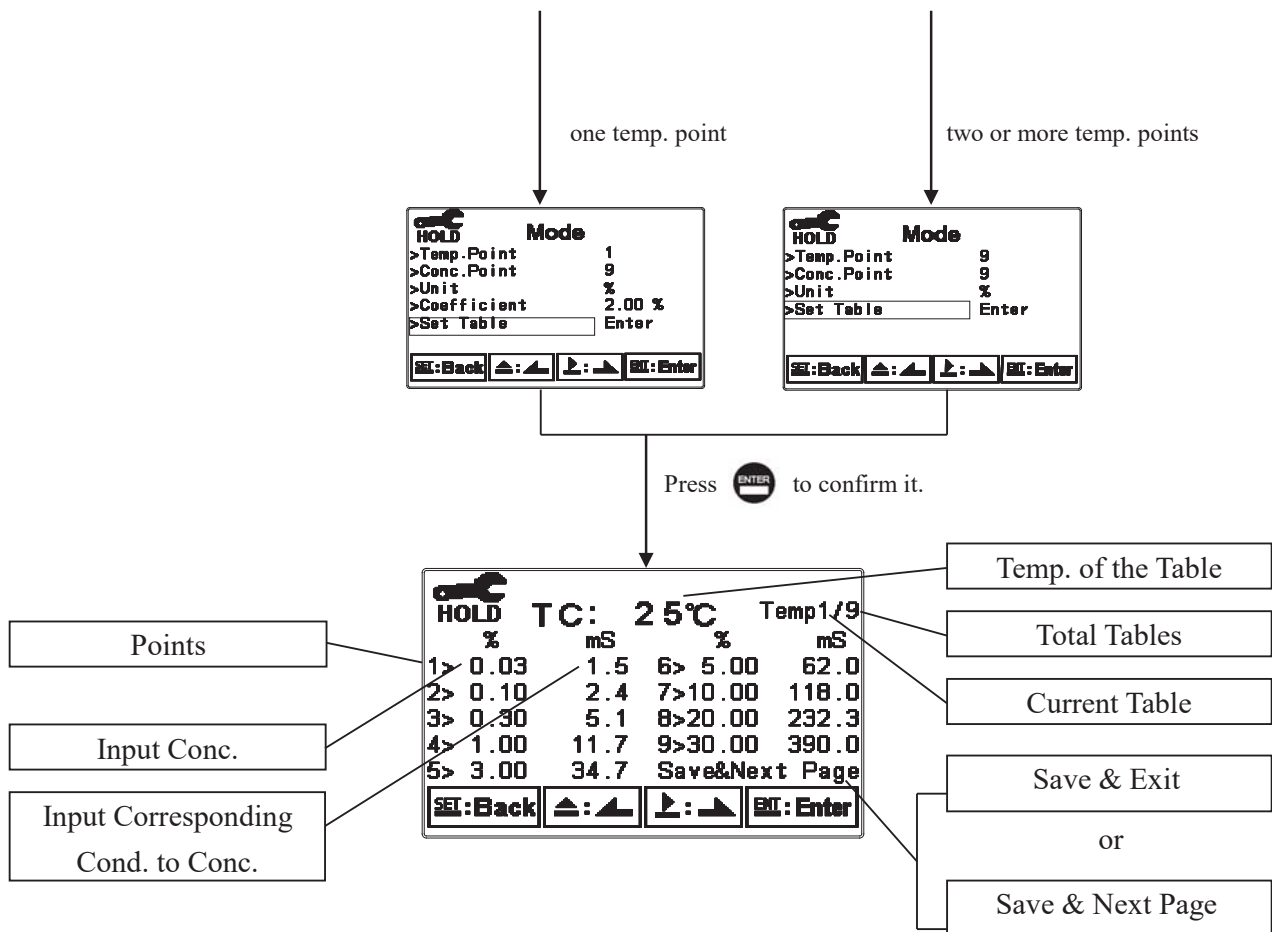

If the temperature is not input in ascending or descending order, there shows Temp. Error on the display screen.

Temp. Error					
HOLD	TC: 15°C	Temp3/9			
%	mS	%	mS		
1> 0.03	1.5	6> 5.00	62.0		
2> 0.10	2.4	7>10.00	118.0		
3> 0.30	5.1	8>20.00	232.3		
4> 1.00	11.7	9>30.00	390.0		
5> 3.00	34.7	Save&Exit			

If the conductivity is not input in ascending or descending order, there shows Cond. Error on the display screen.

Cond. Error					
HOLD	TC: 25°C	Temp1/1			
%	mS	%	mS		
1> 0.03	1.5	6> 5.00	62.0		
2> 0.10	2.4	7>10.00	118.0		
3> 0.30	5.1	8>20.00	232.3		
4> 1.00	4.7	9>30.00	390.0		
5> 3.00	34.7	Save&Exit			

If the concentration is not input in ascending or descending order, there shows Conc. Error on the display screen.

Conc. Error					
HOLD	TC: 25°C	Temp1/1			
%	mS	%	mS		
1> 0.03	1.5	6> 5.00	62.0		
2> 0.10	2.4	7>4.45	118.0		
3> 0.30	5.1	8>20.00	232.3		
4> 1.00	11.7	9>30.00	390.0		
5> 3.00	34.7	Save&Exit			

Concentration %	Hydrofluoric Acid HF Solution mS/cm at 25°C
0.0001	0.01
0.0003	0.03
0.001	0.099
0.003	0.290
0.01	0.630
0.03	1.49
0.1	2.42
0.3	5.1
1.0	11.7
3.0	34.7
5.0	62.0
10.0	118.0
20.0	232.3
30.0	390.0

*Please refer to the concentration and conductivity conversion table of Hydrofluoric Acid (HF)
(for reference only, users need to revise it on their own)

*T.C. coefficient for common solution is within 1.8~2%, but it is 0.7% for Hydrofluoric acid (HF). Besides, according to the changes of concentration, T.C. coefficient changes and thus users need to adjust it depending on the requirements. For example, T.C. coefficient for 0.5%, 1.0%, 3.0% HF is about 0.70%, 0.73%, 0.74%. Users can attain the T.C. coefficient depending on actual situation of measured solution.

*T.C. coefficient for Hydrofluoric Acid (HF)
(for reference only, users need to revise it on their own)

7.4.4 TDS

Enter the setup of Mode, select TDS measuring mode and units from ppm or ppt and set the TDS constant. The default TDS factor is 0.675 ppm / 1 μ S/cm.

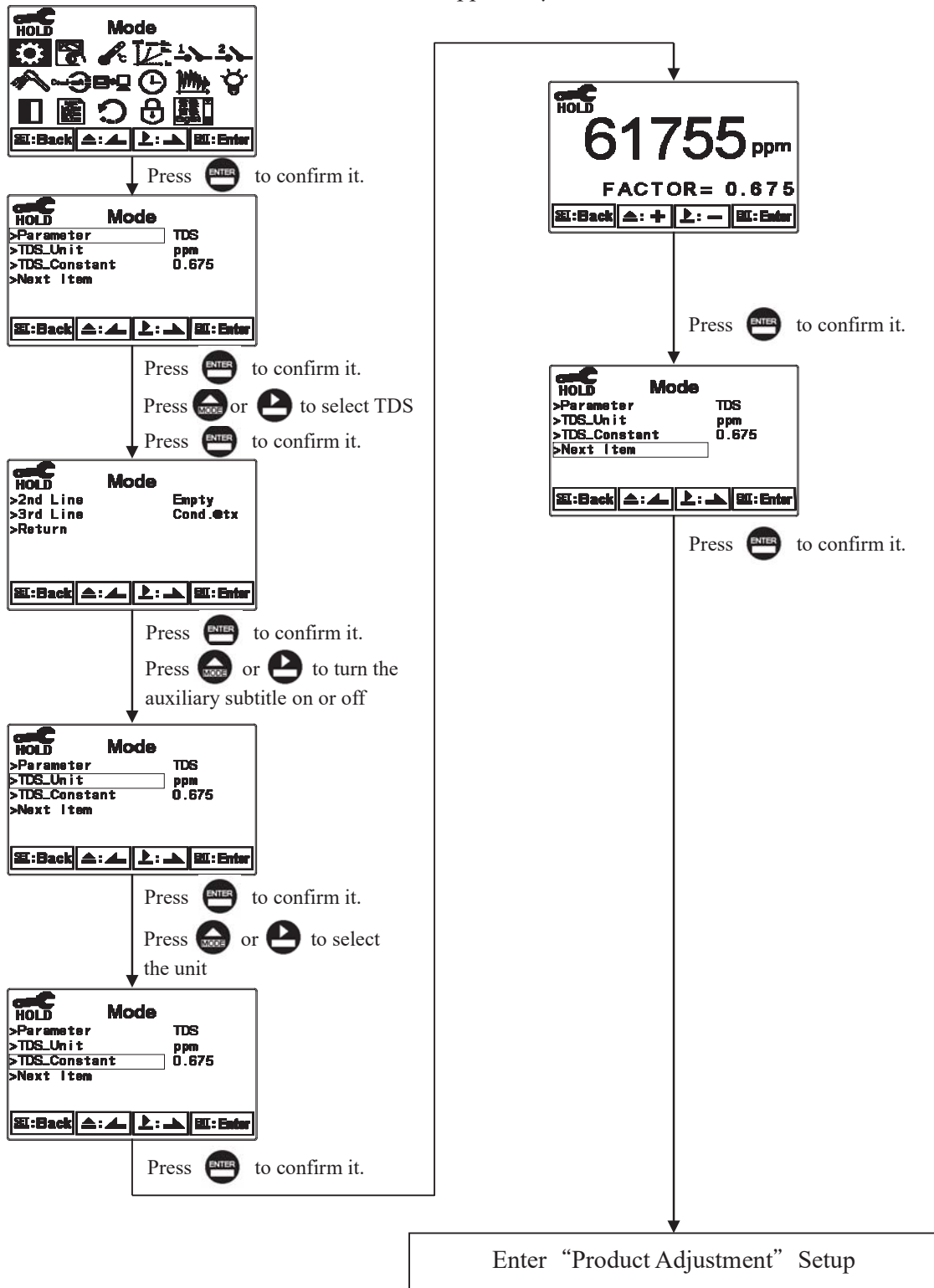

7.4.5 Salinity

Enter setup of Mode and select Salinity measuring mode.

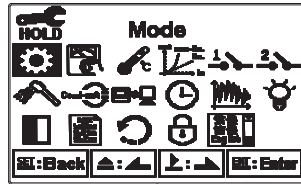

Press to confirm it.

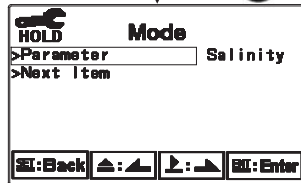

Press to confirm it.

Press or to select TDS

Press to confirm it.

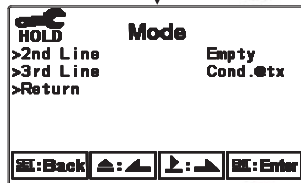

Press to confirm it.

Press or to turn the auxiliary subtitle on or off

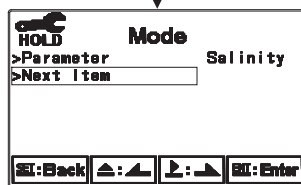

Press to confirm it.

Enter "Product Adjustment" Setup

7.5 Product Adjustment

Enter setup of Product Adjustment to make the fine adjustment of the measurement reading. There is no need for users to take out the sensor from the field and calibrate it. Via this function the measuring values from the field can be compared to the result that came from the sampling and directly adjusted to the same value. If turning on this function, there shows the symbol “PDT” on the display screen.(please refer to ch.6.4 “Warning symbols and text”).

The inductive sensor applies electromagnetic effects to measure the conductivity of a sample solution which can be affected by length of signal cable and the distance between a sensor and the shell of pipe, making an influence on the cell factor and measuring value. At the moment, Product Adjustment can be used to calibrate the measuring value without changing the cell factor.

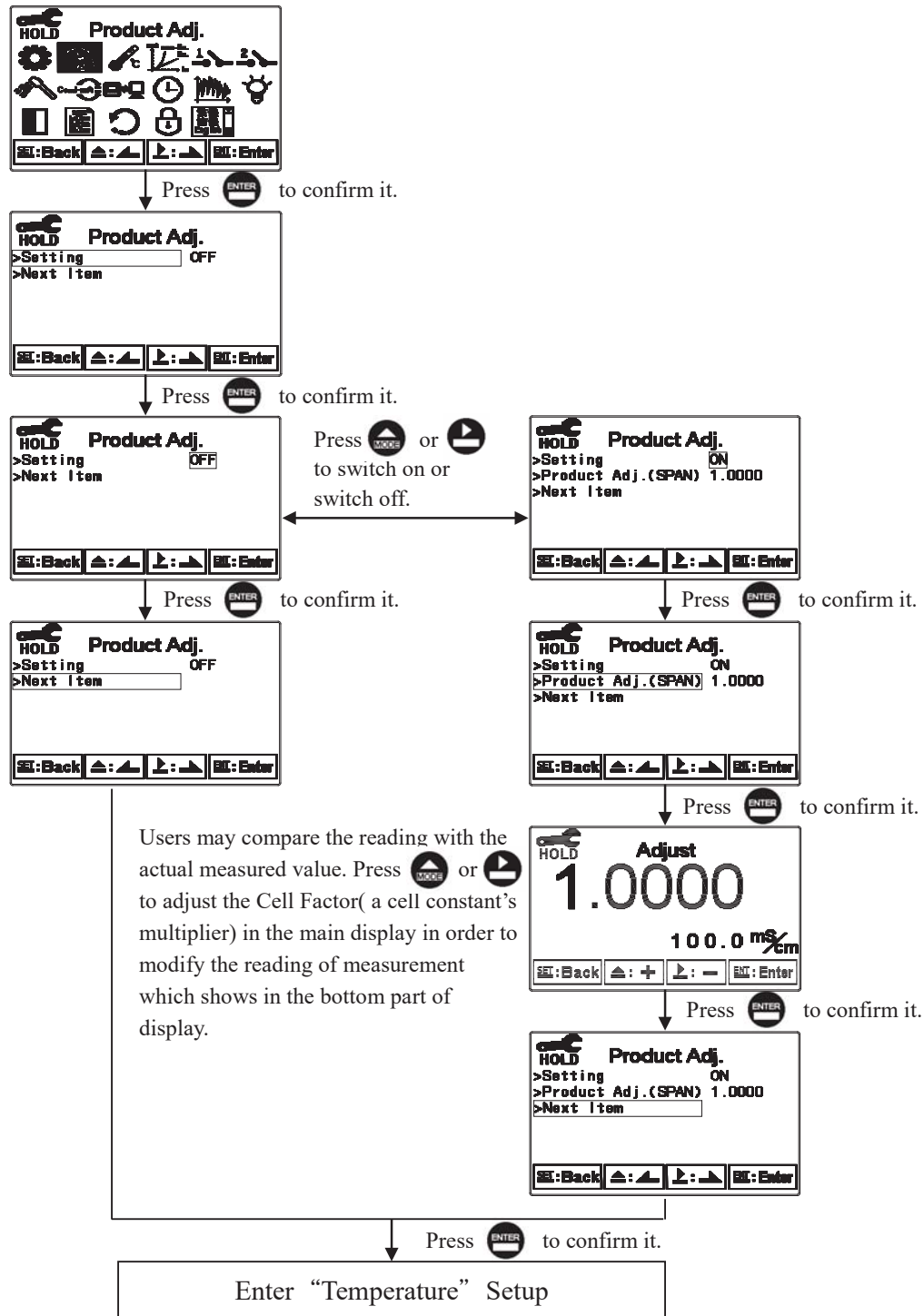

7.6 Temperature

Enter setup of “Temperature” to select temperature probe types. Select from PTC1000 (PT-1000), or NTC(NT30K) for Auto Temperature Compensation, or MTC for manual input compensation.

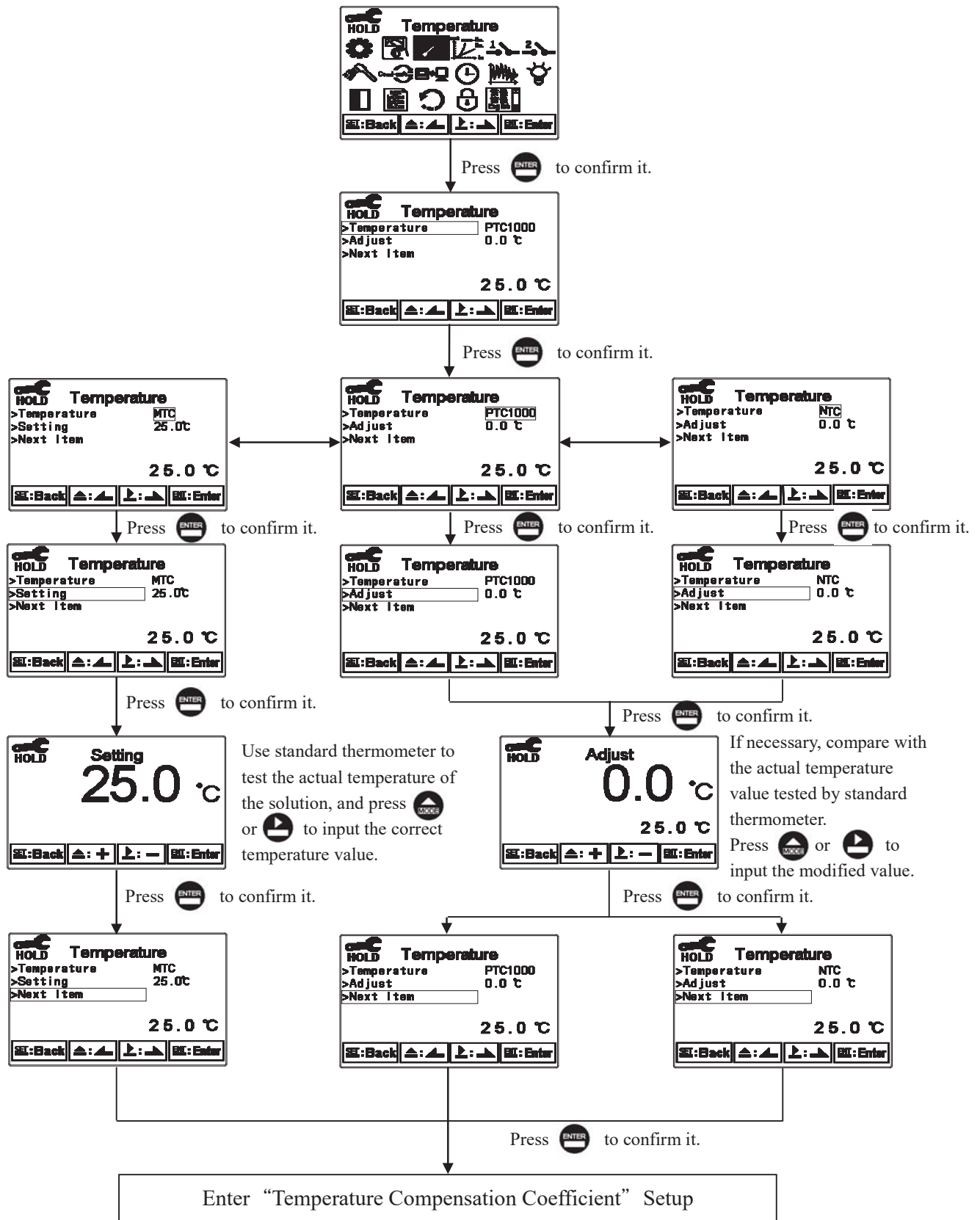

7.7 Temperature Compensation Coefficient

The default setup of temperature compensation reference temperature is 25°C, and temperature compensation coefficient is 2.00%.

Enter setup of Temperature Compensation Coefficient mode and select T.C. coefficient from Linear, Non-Linear or No according to measurement requirements. Normally, select linear compensation for Conductivity measurement (Cond.).

Temperature coefficient (hereinafter referred to as TC): Conductivity of solution increases with rising temperature. The relationship is as follows:(reference temperature "t_{ref}" is 25°C, users can change depending no requirements)

How to get TC of solution:

C _{tref}	Conductivity at reference temperature	$C_t = C_{tref} \{ 1 + \alpha (T - t_{ref}) \}$
C _{t1}	Conductivity at T1°C	
T ₁	Measured solution temperature	$\alpha = (C_{t2} - C_{t1}) / C_{t1} (T_2 - t_{ref}) - C_{t1} (T_1 - t_{ref})$
C _{t2}	Conductivity at T2°C	
T ₂	Measured solution temperature	
α	Temperature compensation coefficient	

Take an example for 0.01M KCl. Set the TC of the instrument to non-compensated (Lin, 0.00%), and control the temperature at C_{t1}°C and at C_{t2}°C. C_{t1} means the measurement value at 20°C (Such as C₂₀ = 1278μS). C_{t2} means the measurement value at 30°C (Such as C₃₀ = 1552μS). Based on the formulas above, α = 1.94%.

$$\alpha = \frac{1552 - 1278}{1278(30 - 25) - 1552(20 - 25)} \times 100 = 1.94$$

Linear compensation range: 0.00%~40.00%

Temperature compensation range(C_{tref}): PT-1000 / MTC---0°C~200°C

NTC30K-----0°C~130°C

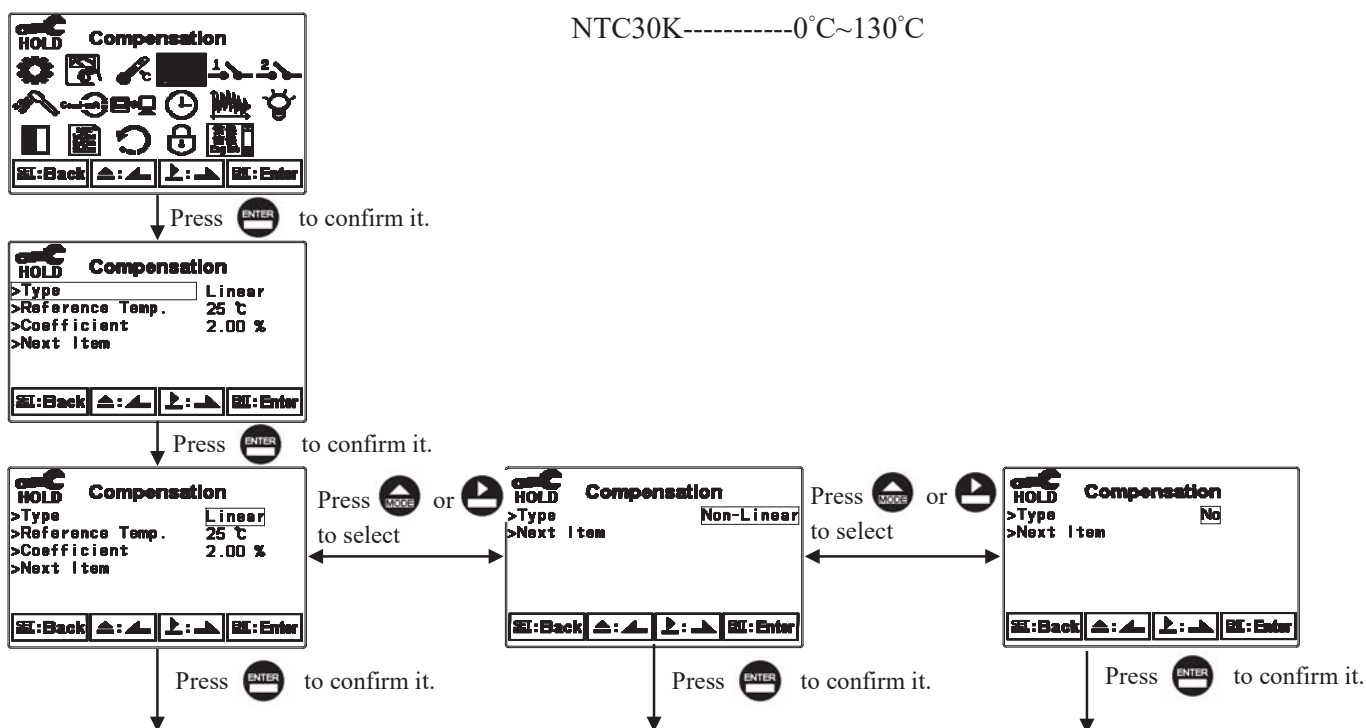

Linear Mode

```

HOLD Compensation
>Type Linear
>Reference Temp. 25 °C
>Coefficient 2.00 %
>Next Item
  
```



⏪: Back ⏴: ▲ ⏵: ▼ ⏹: Enter

Press  to confirm it.

```

HOLD Compensation
      25 °C
  
```

⏪: Back ⏴: + ⏵: - ⏹: Enter

Press  or  to set compensation temperature

Press  to confirm it.

```

HOLD Compensation
>Type Linear
>Reference Temp. 25 °C
>Coefficient 2.00 %
>Next Item
  
```



⏪: Back ⏴: ▲ ⏵: ▼ ⏹: Enter

Press  to confirm it.

```

HOLD Compensation
      2.00 %
  
```

⏪: Back ⏴: + ⏵: - ⏹: Enter

Press  or  to set compensation coefficient.
MAX: 40.00%

Press  to confirm it.

```

HOLD Compensation
>Type Linear
>Reference Temp. 25 °C
>Coefficient 2.00 %
>Next Item
  
```

⏪: Back ⏴: ▲ ⏵: ▼ ⏹: Enter

Non-Linear Mode

```

HOLD Compensation
>Type Non-Linear
>Next Item
  
```

⏪: Back ⏴: ▲ ⏵: ▼ ⏹: Enter

No Mode

```

HOLD Compensation
>Type No
>Next Item
  
```

⏪: Back ⏴: ▲ ⏵: ▼ ⏹: Enter

Press  to confirm it.

Enter "Relay 1" Setup

7.8 Relay 1

Enter setup of Relay 1. Select the item to turn on or turn off of the relay 1 function. If you select to turn on the relay 1, then select for using relay 1 as “High set-point” alarm or “Low set-point” alarm. Set the value of set-point (SP) and Hysteresis (Hys.). The relationship between parameters can refer to an explanatory diagram of the box (as a high point alarm).

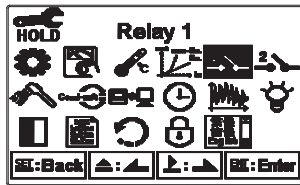

Press **ENTER** to confirm it.

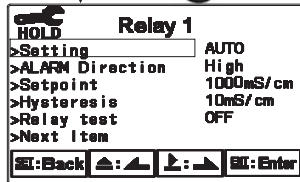

Press **ENTER** to confirm it.

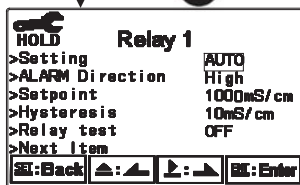

Select AUTO. Press **ENTER** to confirm it.

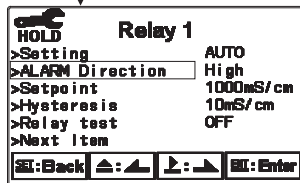

Press **ENTER** to confirm it.



Press **MODE** or **▶** to select Hi point or Lo point alarm.

Press **ENTER** to confirm it.



Press **ENTER** to confirm it.

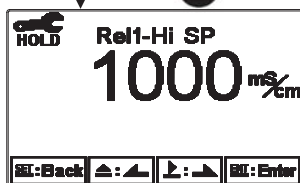

Press **MODE** or **▶** to adjust set-point (SP) value. If the measuring range of conductivity is set as AUTO, then it needs to be set unit (μS/cm or mS/cm), value, and decimal point by orders.

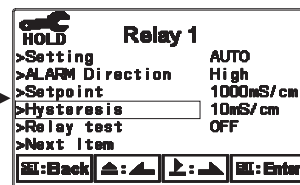
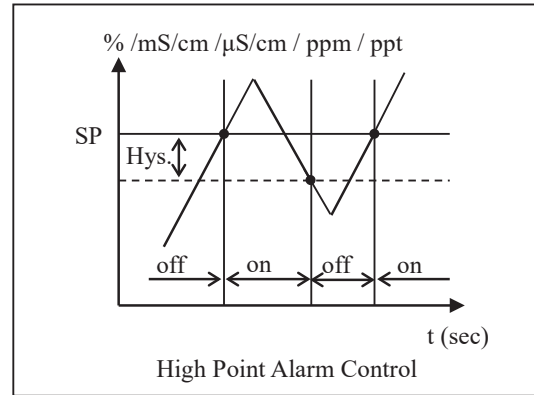

Press **ENTER** to confirm it.

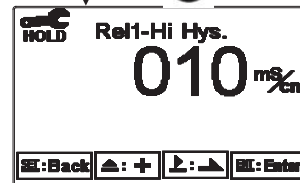

Press **MODE** or **▶** to adjust Hysteresis (Hys.) value

Press **ENTER** to confirm it.

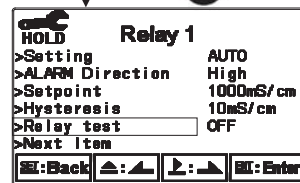

Press **ENTER** to confirm it.

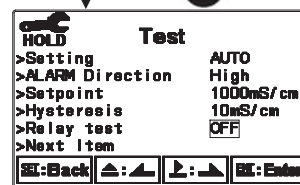

Press **MODE** or **▶** to select to activate a test on REL1. If “ON”, the relay 1 is in action, and the “ACT” indication light will light up.

Press **ENTER** to confirm it.



Press **ENTER** to confirm it.

Enter “Relay 2” Setup

7.9 Relay 2

Enter setup of Relay 2. Select the item to turn on or turn off of the relay 2 function. If you select to turn on the relay 2, then select for using relay 2 as “High set-point” alarm or “Low set-point” alarm. Set the value of set-point (SP) and Hysteresis (Hys.). The relationship between parameters can refer to an explanatory diagram of the box (as a high point alarm).

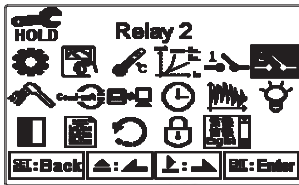

Press **ENTER** to confirm it.

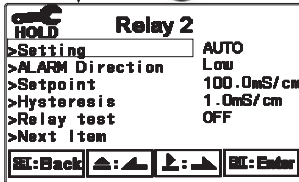

Press **ENTER** to confirm it.

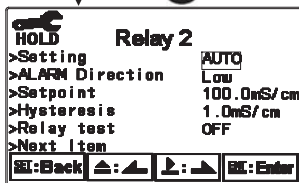

Press **MODE** or **DOWN** to activate Relay 2

Select AUTO. Press **ENTER** to confirm it.

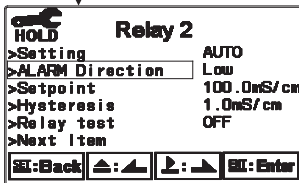

Press **ENTER** to confirm it.

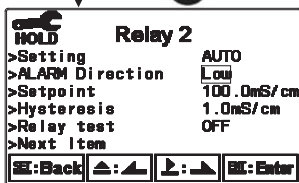

Press **MODE** or **DOWN** to select Hi point or Lo point alarm.

Press **ENTER** to confirm it.

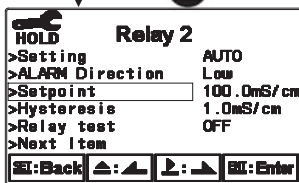

Press **ENTER** to confirm it.

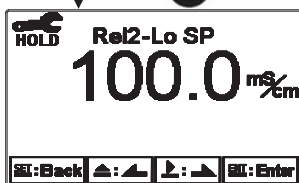

Press **ENTER** to confirm it.

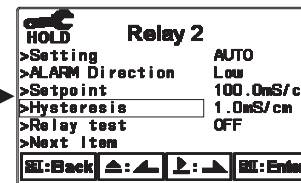
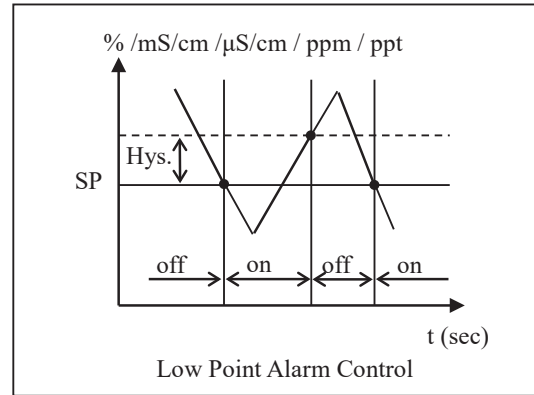

Press **ENTER** to confirm it.

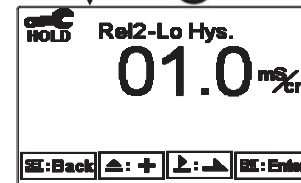

Press **MODE** or **DOWN** to adjust Hysteresis (Hys.) value

Press **ENTER** to confirm it.

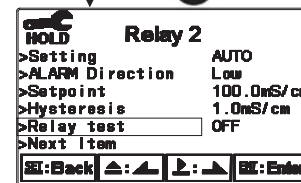

Press **ENTER** to confirm it.

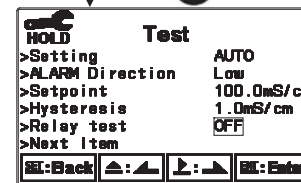

Press **MODE** or **DOWN** to select to activate a test on REL2. If “ON”, the relay 2 is in action, and the “ACT” indication light will light up.

Press **ENTER** to confirm it.

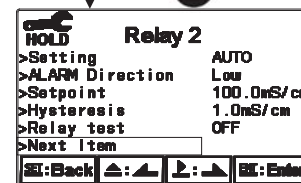

Press **ENTER** to confirm it.

Enter “Clean” Setup

7.10 Clean

Enter setup of “Clean” function. Select the icon to turn on or turn off the clean function. If you select “Auto” turning on, then set the timer of the clean function including automatically turning on time and turning off time, and set the Hysteresis value (Hys.).

Note: When the clean function is turned on, if any value is set to be 0, the instrument will automatically turn off this function. When the clean function is activated under measurement mode, there is a “Clean Running” message showing on top of the display. The measurement value will be remained at the last measured value before cleaning. If enter setting menu or calibration menu under clean status, the instrument will stop clean status automatically.

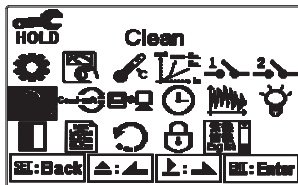

Press **ENTER** to confirm it.

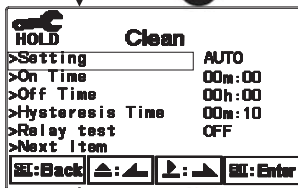

Press **ENTER** to confirm it.



Press **MODE** or **←** to select to activate Clean or not.

Press **ENTER** to confirm it.

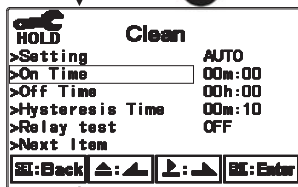

Press **ENTER** to confirm it.



Press **MODE** or **←** to adjust the auto turning on time. Press **ENTER** to confirm the minute part, and move to adjust the second part.

Press **ENTER** to confirm it.

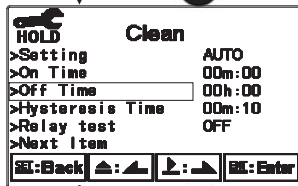

Press **ENTER** to confirm it.

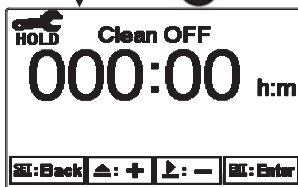

Press **MODE** or **←** to adjust the auto turning off time. Press **ENTER** to confirm the minute part, and move to adjust the second part.

Press **ENTER** to confirm it.

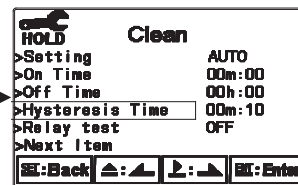
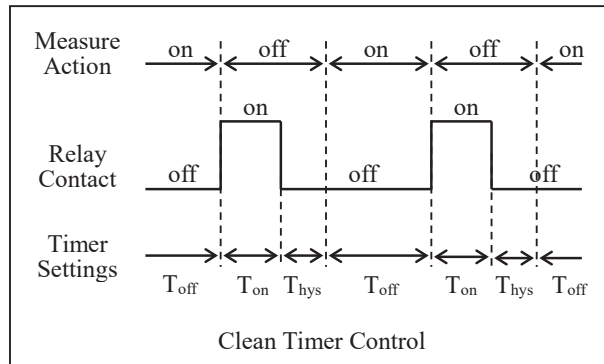

Press **ENTER** to confirm it.



Press **MODE** or **←** to adjust duration time for Hysteresis (Hys.). Press **ENTER** to confirm the minute part, and move to adjust the second part.

Press **ENTER** to confirm it.

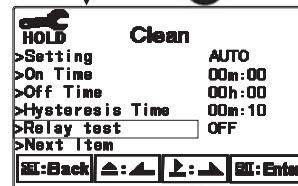

Press **ENTER** to confirm it.

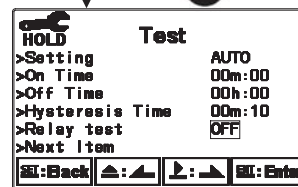

Press **MODE** or **←** to select to activate a test of Clean or not. If “ON”, the Clean function is in action, and the “ACT” indication light will light up.

Press **ENTER** to confirm it.

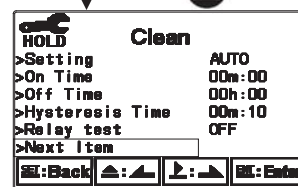

Enter “Current Output” Setup

7.11 Current Output

Enter setup of Current Output. Select 0~20mA or 4~20mA current output. Set the related value to the range of Cond. measurement. If the range of the Cond. measurement is to be set smaller, the resolution of current output is higher. When the measured value exceeds the higher range limit, the current will remain approximately 22mA output. When the measured value exceeds the lower range limit, under 0~20mA mode the current output will remain 0mA output; while under 4~20mA mode the current output will remain approximately 2mA output. The exceptional output value can be used as a basis for failure determination. Under HOLD(measurement) status, the current output maintain the last output value before HOLD status. However, in order for convenience of insuring the current setting of an external recorder or of a PLC controller, the current output will be 0/4mA or 20mA under the analog output setup menu.

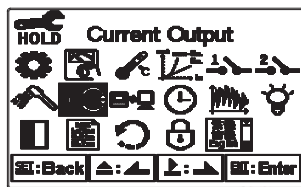

Press to confirm it.

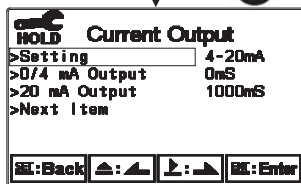

Press to confirm it.

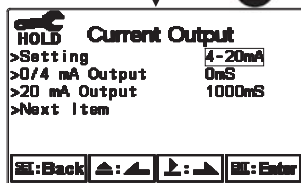

Press to confirm it.

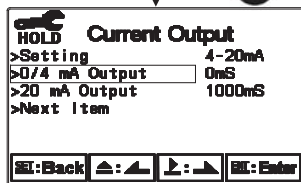

Press to confirm it.

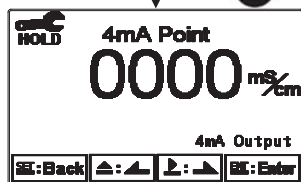

Press to confirm it.

Press or to select to current output range, 0-20mA or 4-20mA.

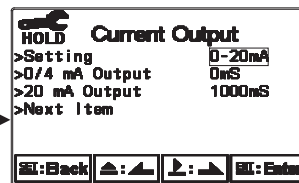

Press to confirm it.

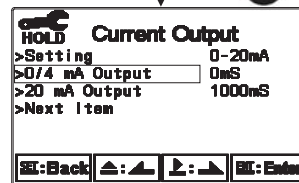

Press to confirm it.

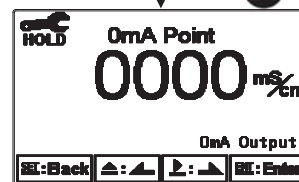

Press to confirm it.

Press or to set the lower limit of Cond. value relative to 4.0mA output signal. If the measuring range of conductivity measurement is set as AUTO, then it needs to be set unit(μ S/cm or mS/cm), value, and decimal point by orders.

Press or to set the lower limit of Cond. value relative to 0.0mA output signal. If the measuring range of conductivity measurement is set as AUTO, then it needs to be set unit(μ S/cm or mS/cm), value, and decimal point by orders.

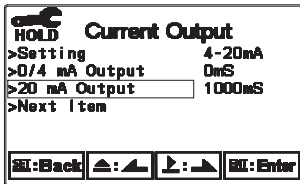

4-20mA

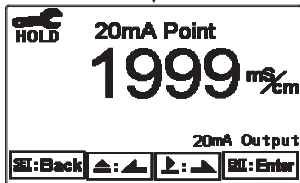

Press  to confirm it.

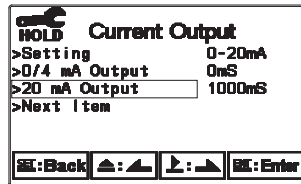
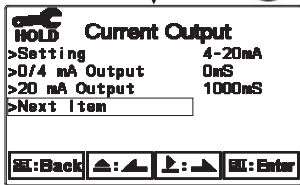

0-20mA

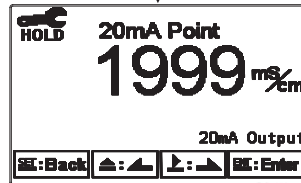

Press  to confirm it.

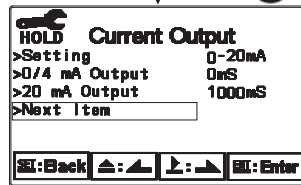

Enter "RS-485 Communication" Setup

7.12 RS-485 Communication

Enter setup of RS-485 communication. According to the Modbus protocol, set the Transmitting Mode, Baud Rate, Parity, Stop Bit, and ID number. About the detail of Modbus protocol, please refer to Ch9 Modbus Protocol. If under HOLD status, the measurement signal output maintains the last output value before HOLD status.

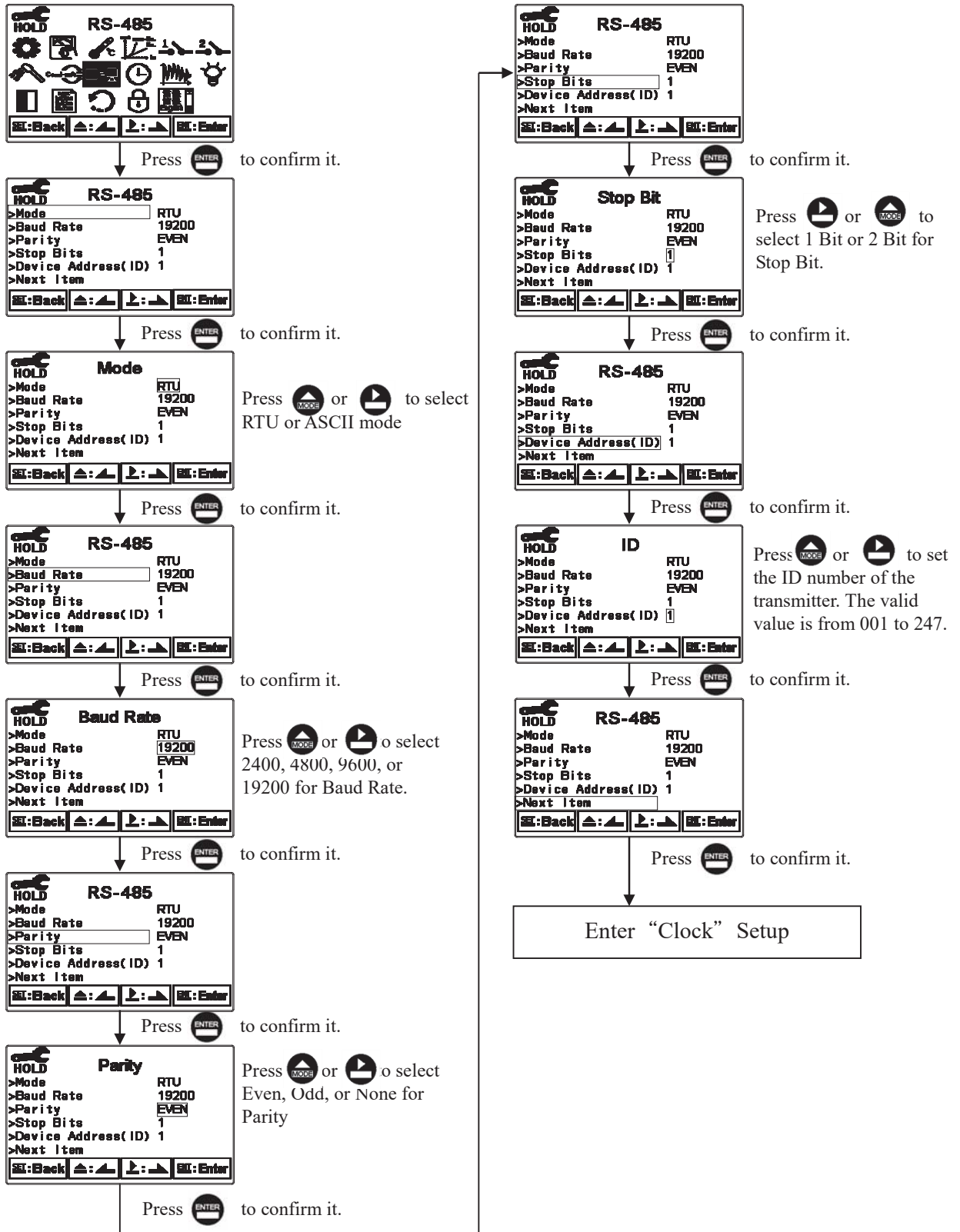

7.13 Clock

Enter setup of Date/Time(Clock). Set the “Year”, “Month”, “Date”, “Hour”, and “Minute” time.
 Note: If you select to turn off the clock function, there will not display clock under measurement mode. The calibration time of calibration record will also show ”OFF” under calibration overview display.

Note: The transmitter may keep the clock in operation even when encountering power failure. Only when the inner battery is out of power, the clock may stop operation. Then, please replace the 3V CR2025/2032 Li batter inside the transmitter.

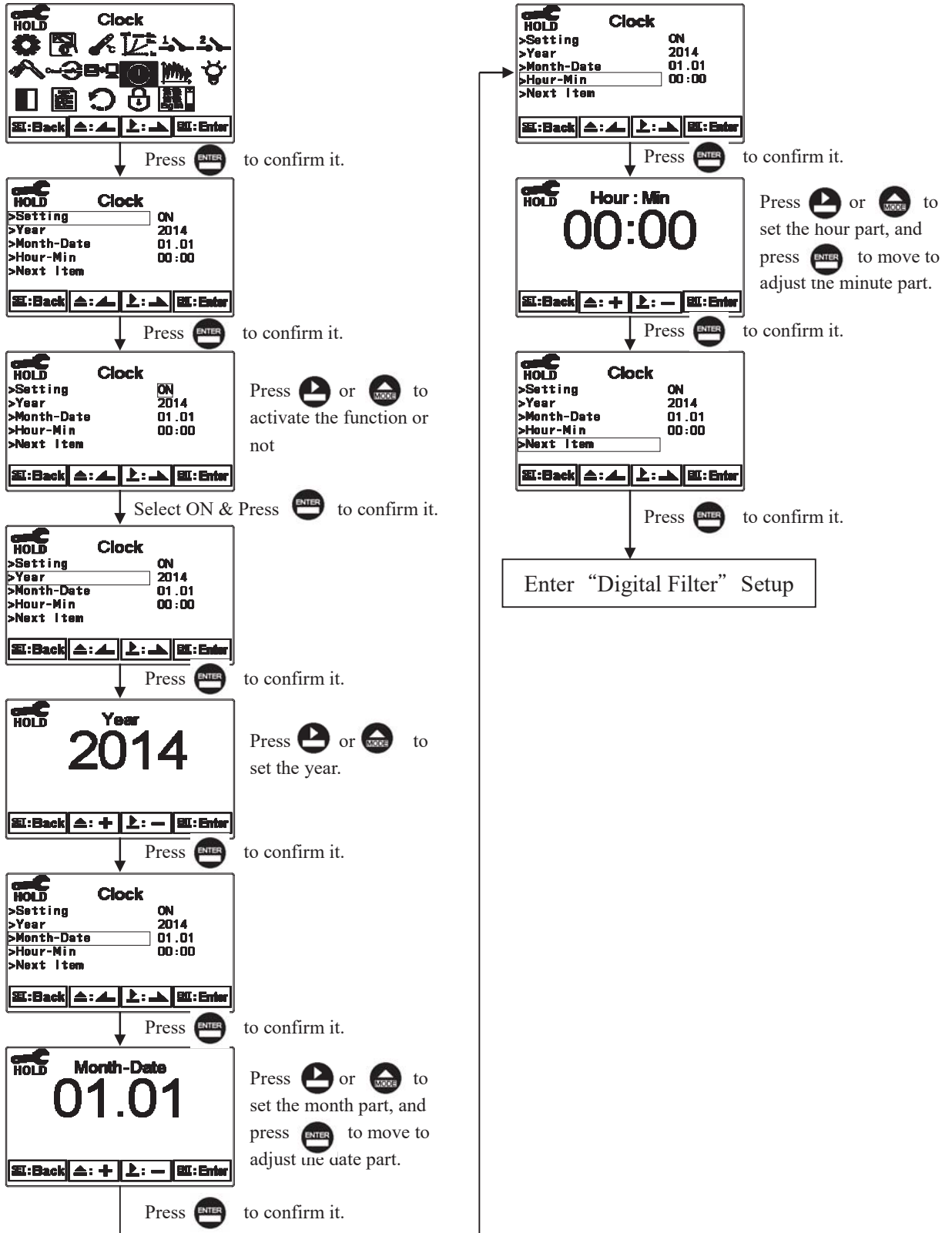

7.14 Digital Filter

Enter the setup of Digital filter. You may select the number of sample to be averaged each time to become a reading which is gradually counted in order to increase the stability of measurement.

Note: “0” represents Automatic Setting according to the conductivity measurement range.

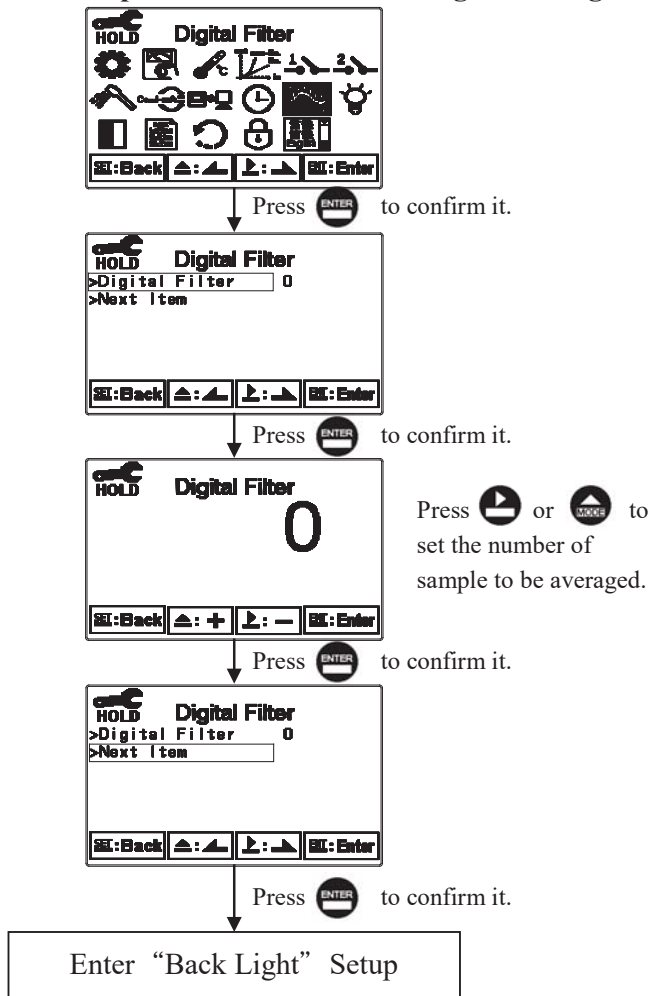

7.15 Back Light

Enter setup of backlight display. According to users' requirements, the brightness of display (-2~2, dark~bright) and sensitivity of the sensitization sensor(-2~2, insensitive~sensitive) can be set. On OFF or AUTO backlight mode, if there is a keystroke, then it activates the touch-on state, activating the backlight. If there is no keystroke for 5 seconds, the display will be back to the original backlight setting status.

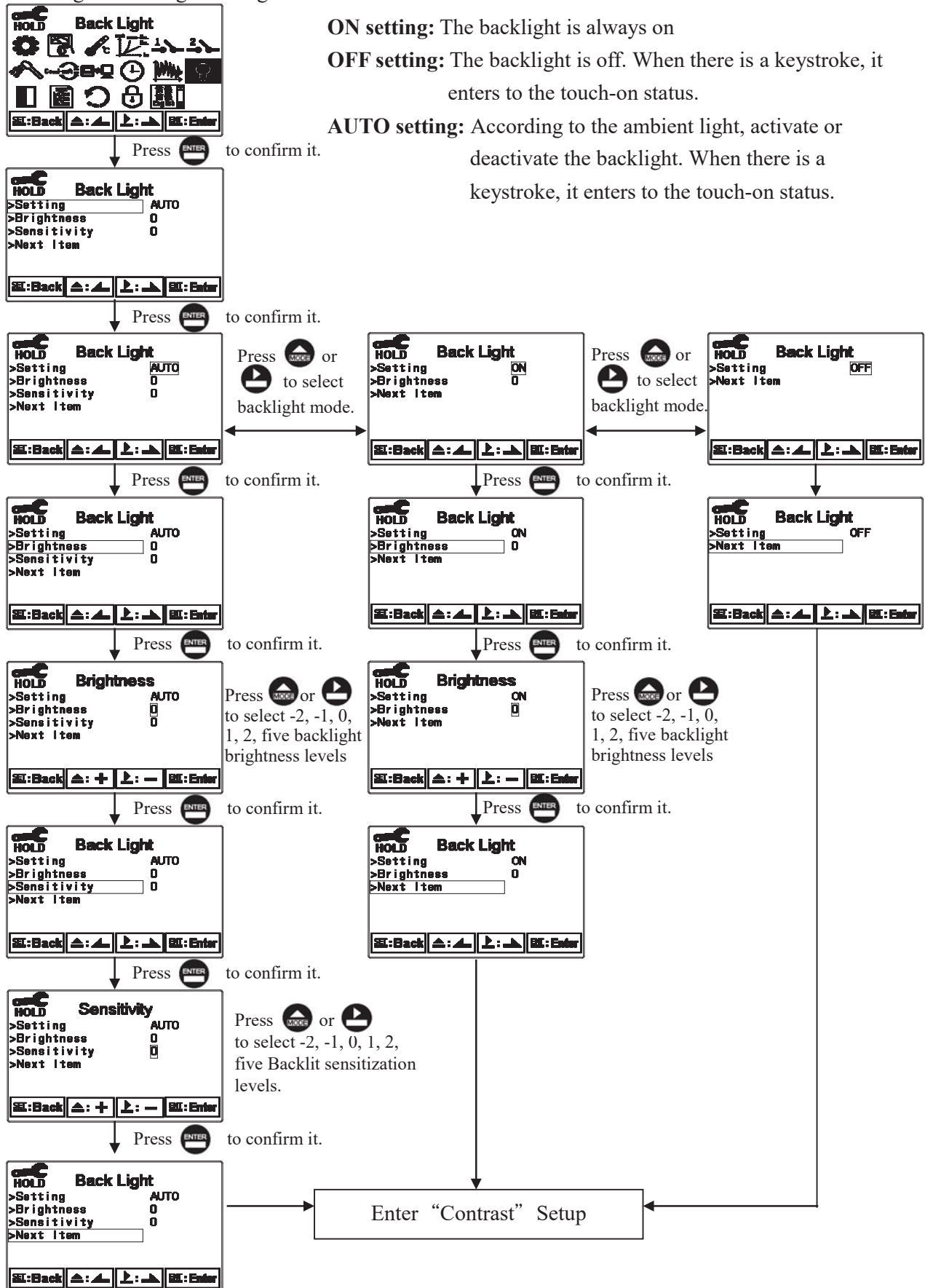

ON setting: The backlight is always on

OFF setting: The backlight is off. When there is a keystroke, it enters to the touch-on status.

AUTO setting: According to the ambient light, activate or deactivate the backlight. When there is a keystroke, it enters to the touch-on status.

7.16 Contrast

Enter setup of Contrast. You can set the contrast of display according to your need. (-2, -1, 0, 1, 2, low to high).

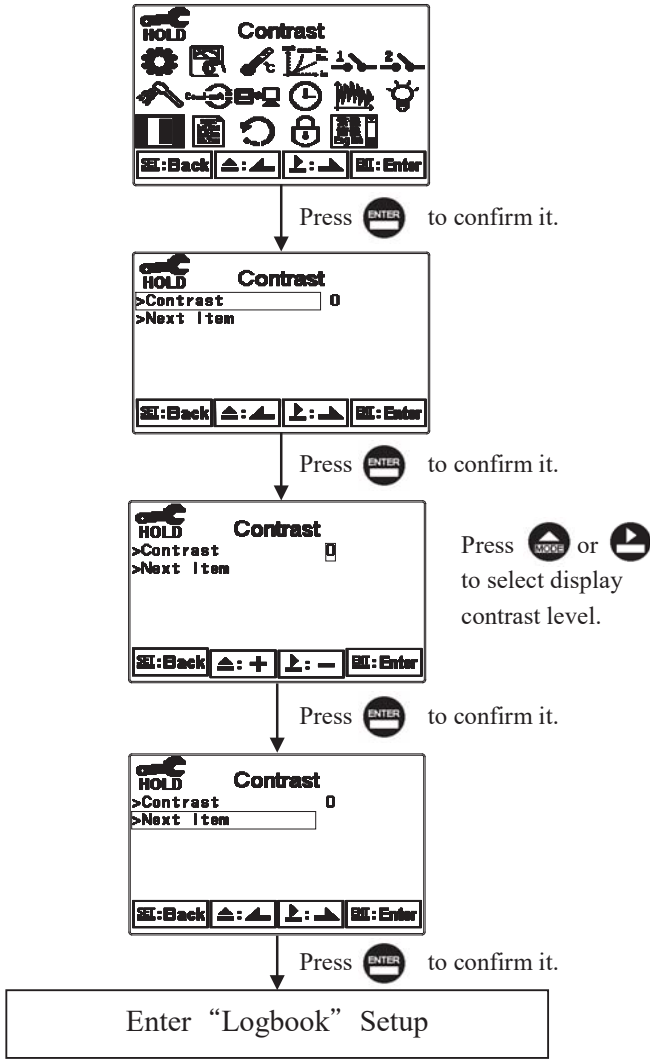

7.17 Logbook

Enter setup of Logbook. Users may look up the relative 50 records of the transmitter showed on the display screen or read by Modbus. The event descriptions are as follows. If users would like to use Modbus to read the event records, they need to type the serial number 0028 first, and then they can attain the corresponding event records from 0029H~002FH. Serial number 1 means the latest event, serial number 2 means the former event, and so on.

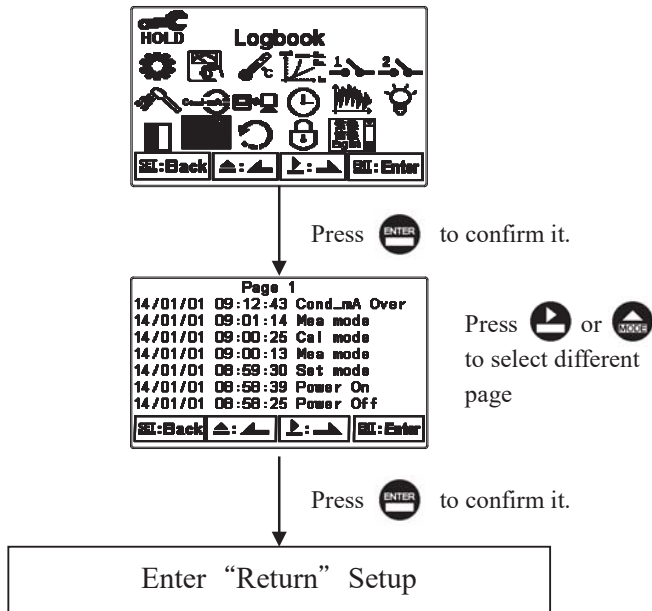

Event	Description	Modbus code
Mea mode	Measurement mode	00
Set mode	Setting mode	01
Cal mode	calibration mode	02
Power On	The unit is powered up	03
Power Off	The unit is out of power	04
Cond_mA Over	Current is over range (Conductivity mode)	05
Error 1	Unstable reading during calibration	06
Error 2	1. Cell factor exceeds the upper/lower limit 2. Temperature is over range	07
Error 3	Wrong password	08
Conc_mA Over	Current is over range (Concentration mode)	09
Error 9	The unit is broken	10
Modbus Write	Modbus input action	13

7.18 Return

Enter setup of auto return mode (Return) to set the function that the instrument automatically exit the setup menu after a period of time without pressing any key. The “Manual Exit” means that it needs to exit setup menu manually, while “Auto” means that the display automatically exit the setup menu and back to measurement mode after a period of time without pressing any key.

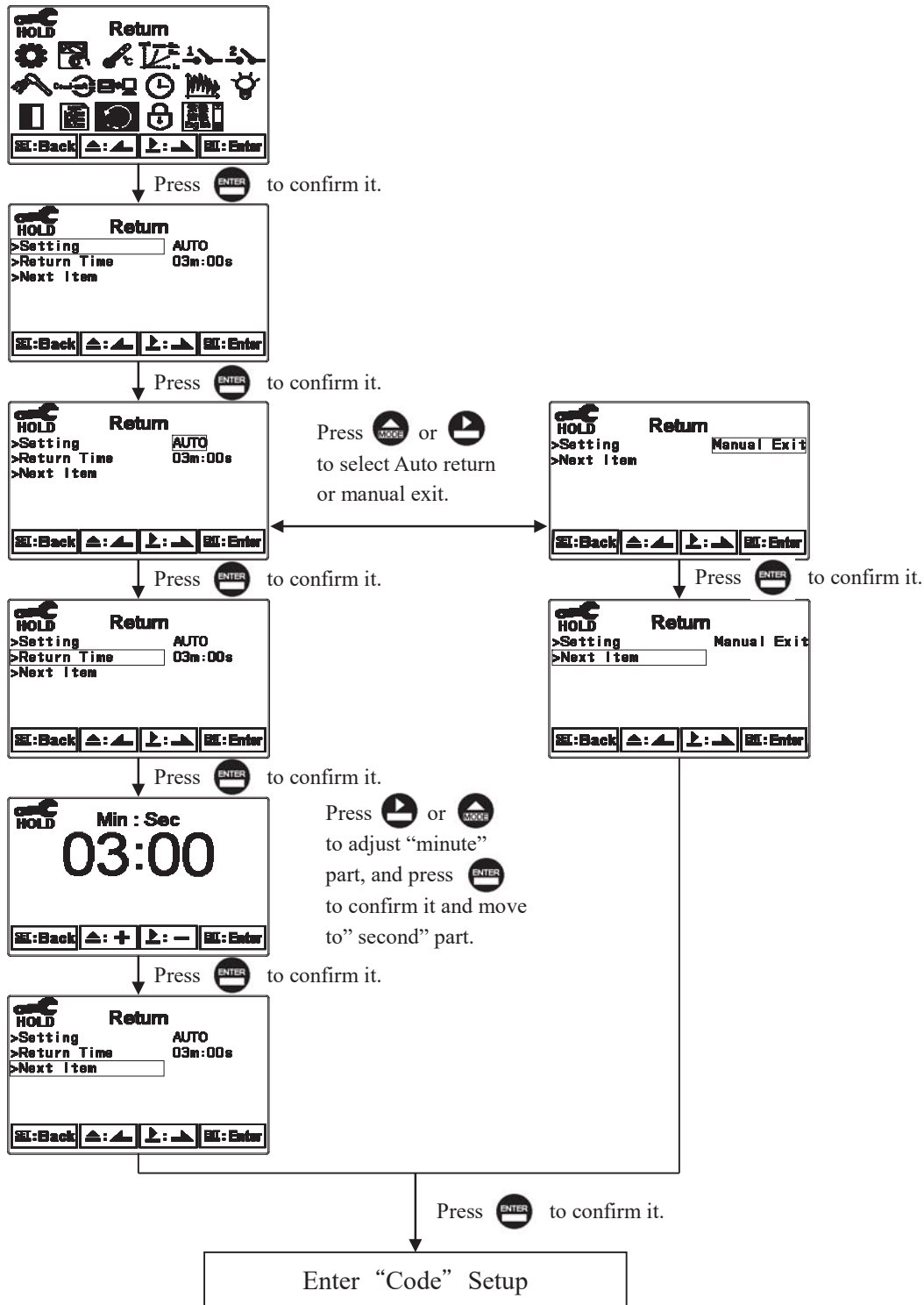



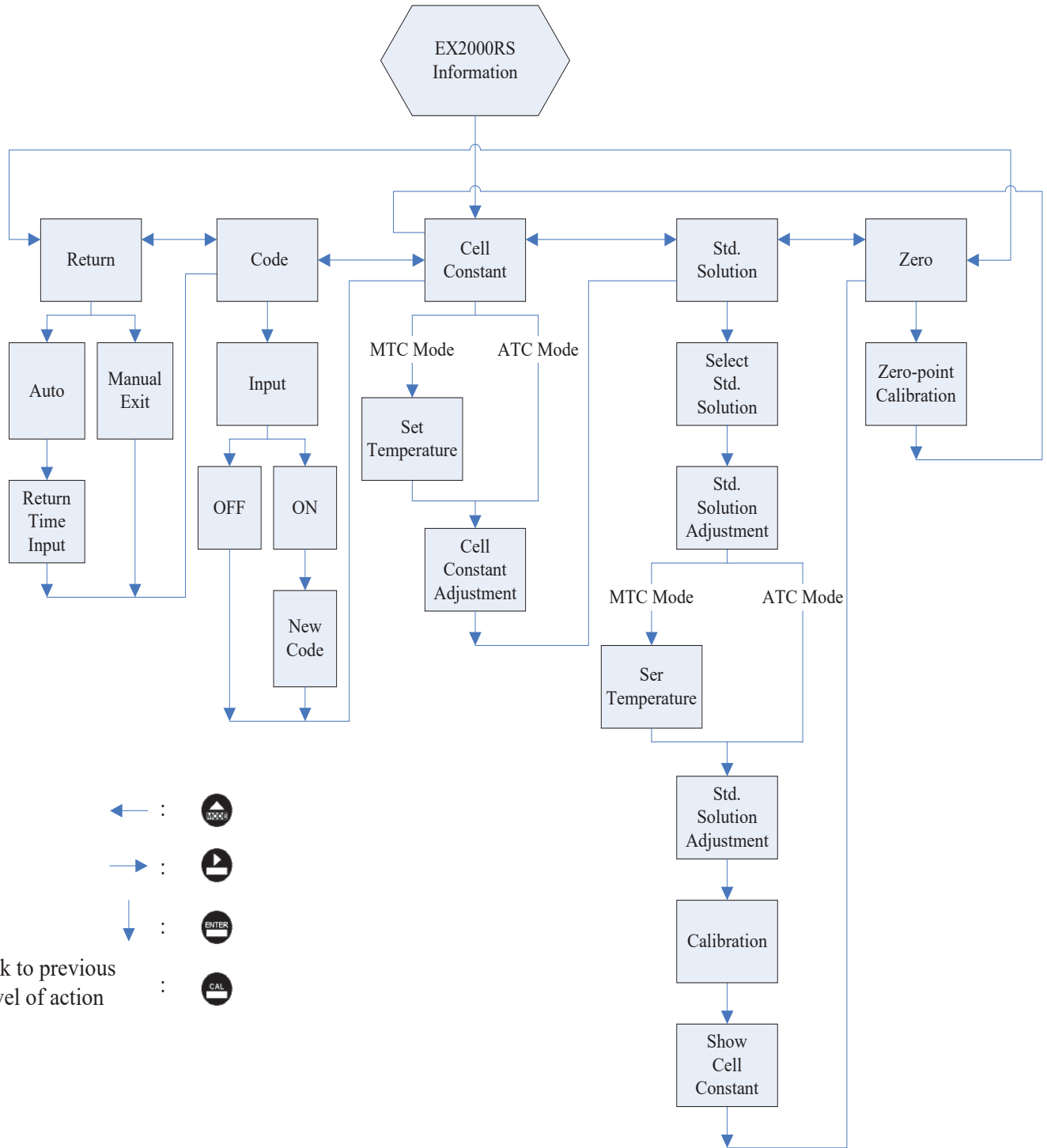

8. Calibration

Block diagram of Calibration



- ← :
- :
- ↓ :
- Back to previous level of action :

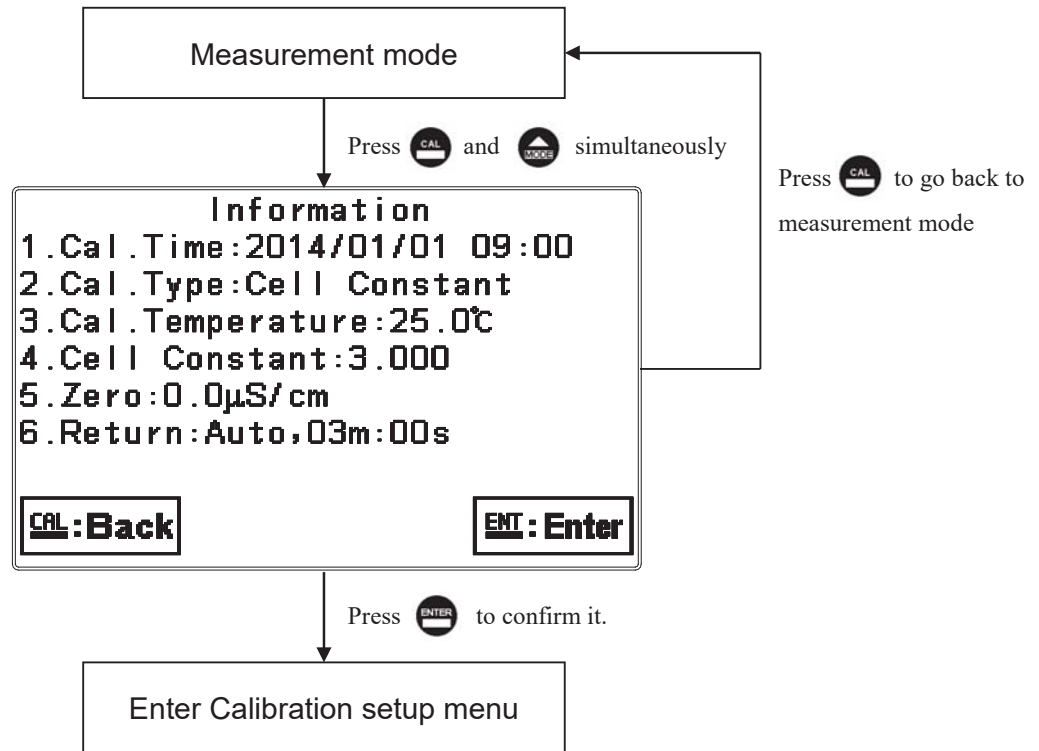

8.1 Enter calibration setup menu

In the measurement mode, pressing the two keys  and  simultaneously allows you to enter the Calibration Information. If you do not need to re-calibrate the measurement system, press  to go back to measurement mode. If you need to re-calibrate the system, press  to enter to the calibration setup menu. (If the calibration time shows “OFF”, it represents that the clock function has been turned off.)



8.2 Security password of calibration (Code)

Select the Code (password) icon after entering calibration setup mode. Select to activate code function or not. The default Calibration setting code is “1100”.

If you input a wrong code, then the display shows a “Error Code” message. Press  to restart inputting another code, or press  to exit the calibration menu.

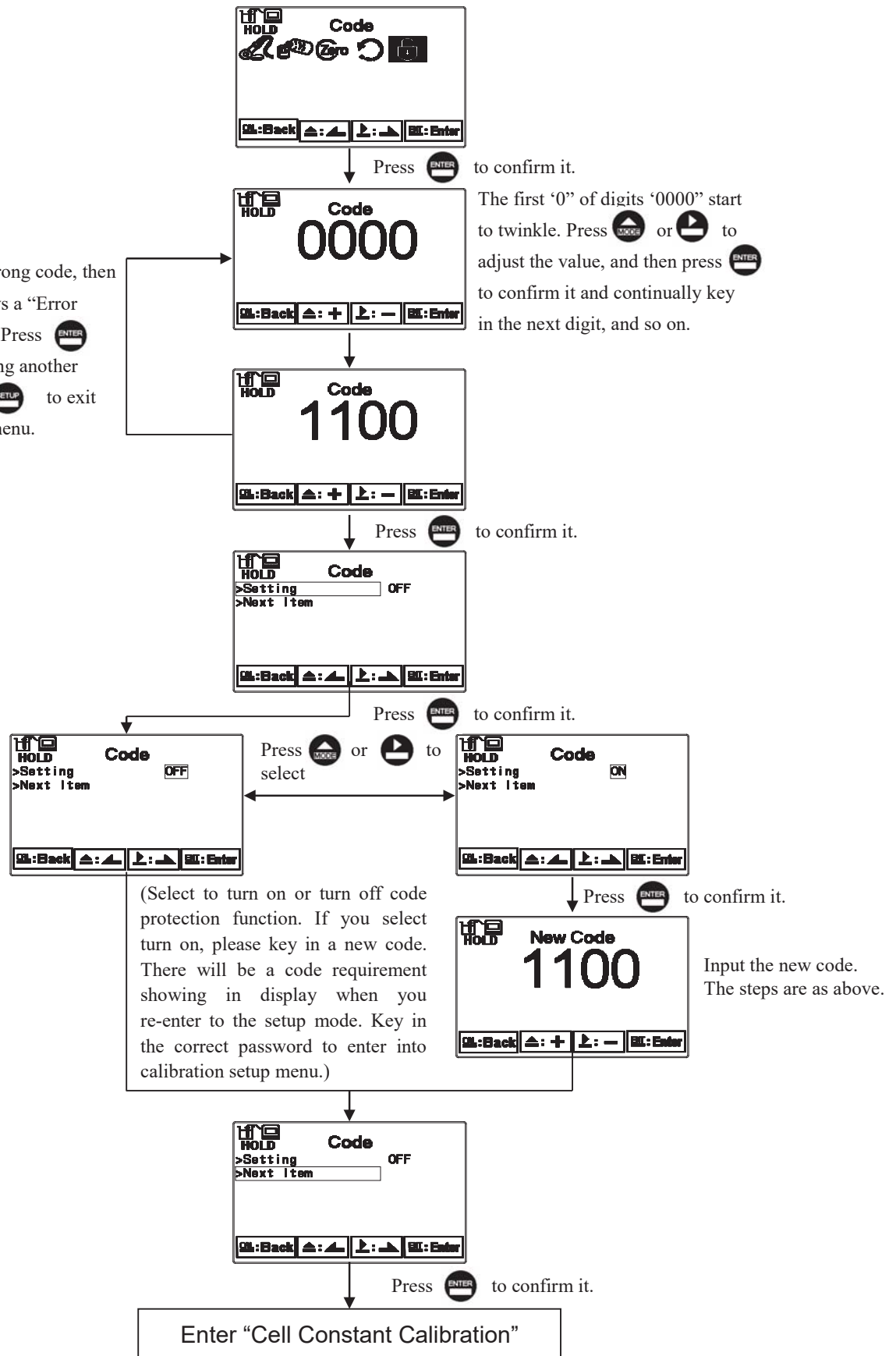

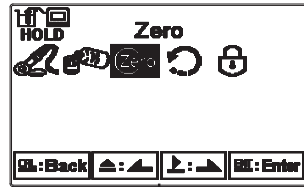

8.3 Zero-Point Calibration

The inductive sensor connected with the transmitter needs to make a zero point calibration in the air. Before calibration, it is necessary to make sure that the surface of the inductive sensor is dry and clean and also in the air. After selecting Zero point calibration and then pressing Enter, the transmitter will directly calibrate zero point and then display the value.

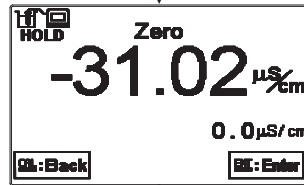

Press  to confirm it.



As the main value is stable and auxiliary value is 0, which means the calibration has been finished well, and then press to  confirm it and see the calibration information.

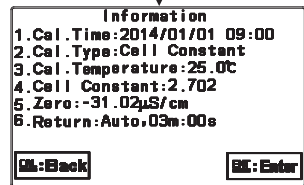

8.4 Cell Constant Calibration

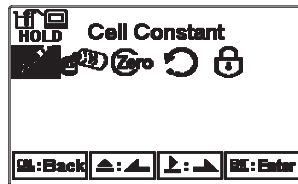

The inductive sensor is immersive to a tested solution, and then input the cell constant which is qualified in lab and marked on the sensor signal cable.

Due to the fact that the inductive sensor applies electromagnetic induction principle which belongs to non-contact technology to detect the conductivity of a sample solution. Thus, the signals may get affected by surroundings such as wall effects, metal(conductor) pipeline or plastic(insulation) pipeline, distance between the inductive sensor and shell of pipe, etc. the actual measurement value from the field may be dissimilar to that from the lab. At the moment, by adjusting the cell constant, Cell Constant Calibration can be made on the field.



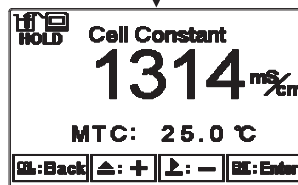

Press  to confirm it.

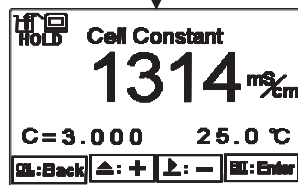

Under MTC temperature mode, press  or  to adjust temperature value; under ATC temperature mode(PTC or NTC), it reads the temp. directly.

Press  to confirm it.



Press  and  to input the cell constant labeled on the sensor.

Press  to confirm it.

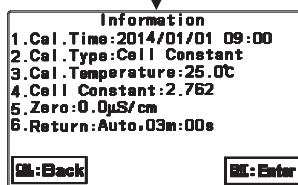

8.5 Standard solution calibration (Std. Solution)

KCl and NaCl standard solutions can be selected.

1. In the lab, place the inductive sensor into the calibration solution for 30 minutes above. Keeping it at least 3 cm distance from the wall of a container is to avoid wall effects to cell constant. Then, Cell Constant by the lab can be attained.
2. Via pipeline installation from the field the standard solution is flown to the inductive sensor, wall effects can be calibrated and thus Cell Constant from the field can be attained.
3. It is recommended to use labeled cell constant to calibrate the sensor on the field and cooperate with product adjustment function. please refer to ch7.8 Product Adjustment.
4. It is necessary to make sure that the temperature between the inductive sensor and standard solution should be the same in order to avoid temperature effects.

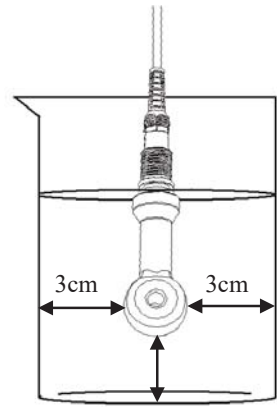

Note: it is necessary to make a zero-point calibration first before standard solution calibration when the inductive sensor runs for the first time.

8.5.1 KCl Standard Solution

Total 3 standard solutions including 111.8 mS/cm(1 mol/L), 12.88 mS/cm (0.1 mol/L) and 1.413 mS/cm (0.01 mol/L) can be selected.

Please refer to “Appendix Calibration Solution: Conductivity and Temperature Table” for your reference.

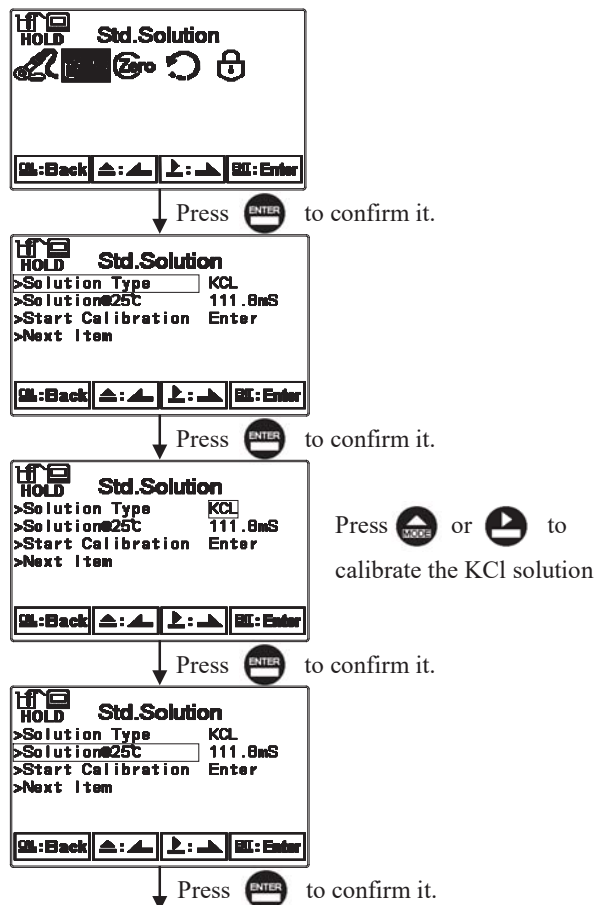

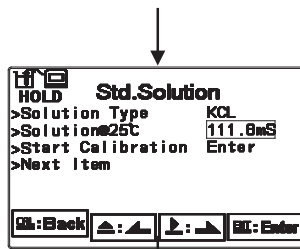

Press or to select standard solutions from 111.8mS/cm, 12.88mS/cm or 1.413mS/cm.

Press to confirm it.

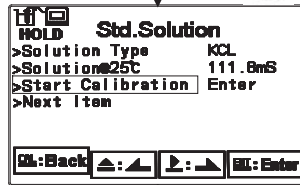

Press to confirm it and start calibration.

ATC Mode

MTC Mode

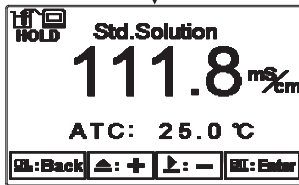

Press or to adjust the standard solution value. Press to confirm it.

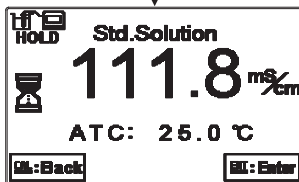

The system measures the standard solution. Press to show the reading, or wait for the reading which shows automatically.

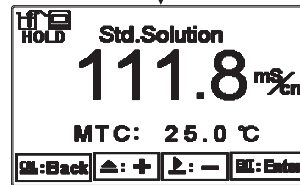

Under MTC temperature mode, press or to adjust temperature value.

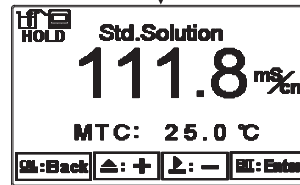

Press or to adjust the standard solution value. Press to confirm it.

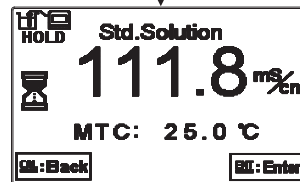

The system measures the standard solution. Press to show the reading, or wait for the reading which shows automatically.

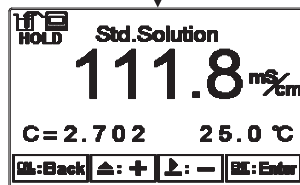

Display shows calculated cell constant value.

Press to confirm it and display the calibration result.

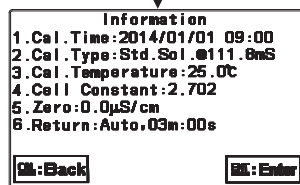

8.5.2 NaCl Standard Solution

Total 2 standard solutions including 10.683 mS/cm (0.1 mol/L) and 251.3 mS/cm (saturated) can be selected.

Please refer to “Appendix Calibration Solution: Conductivity and Temperature Table” for your reference.

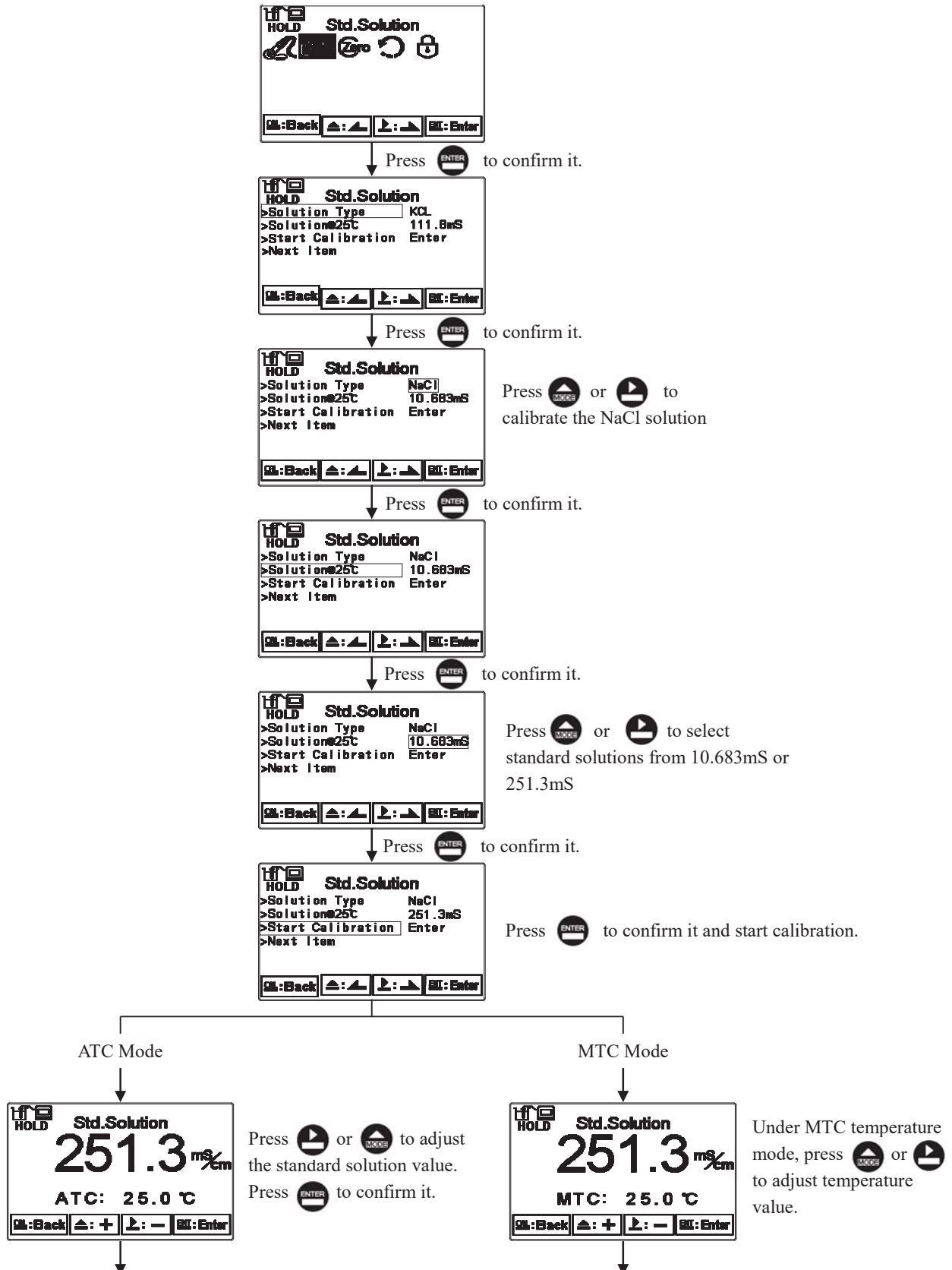

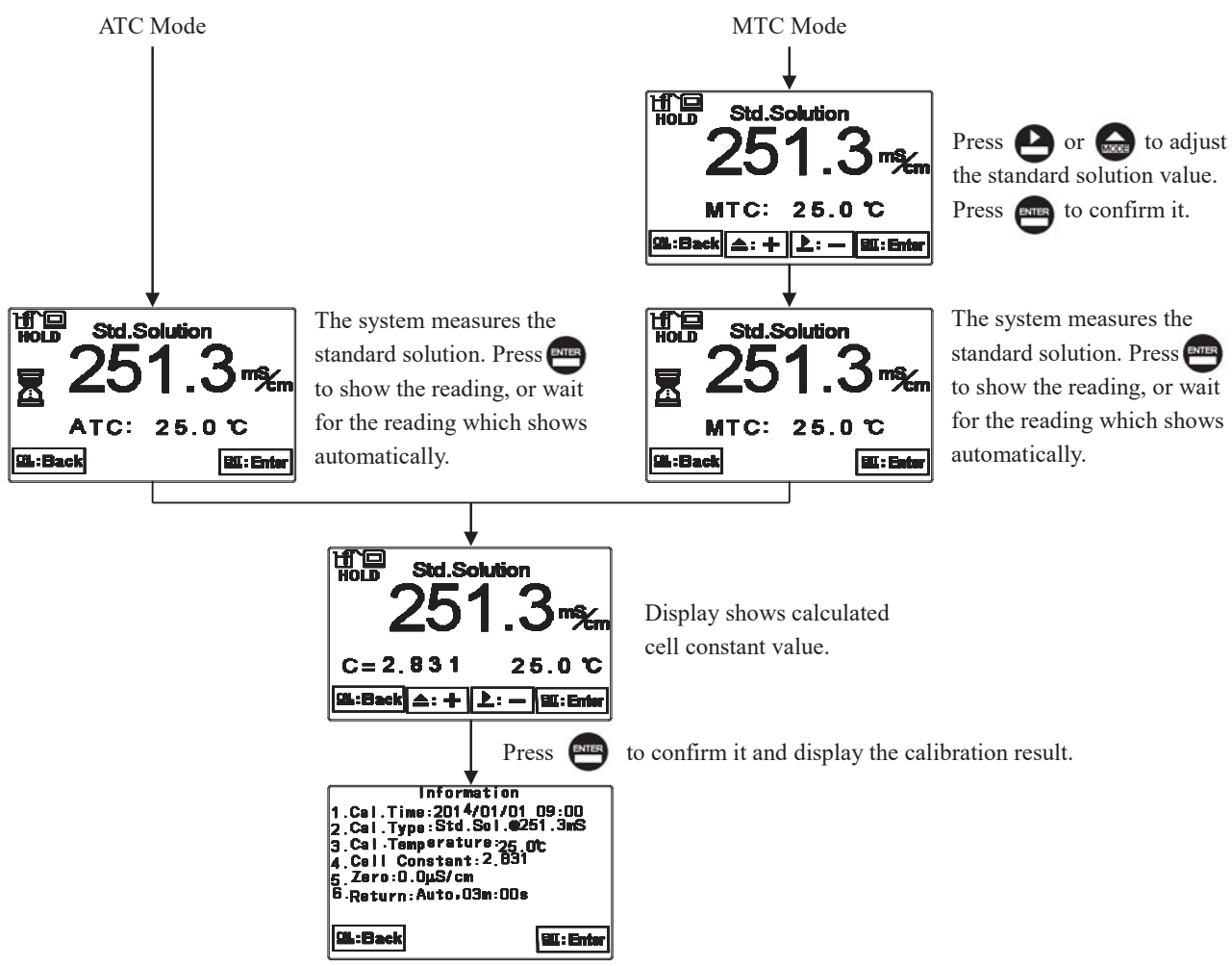

8.6 Return

Enter setup of auto return mode (Return) to set the function that the instrument automatically exits the setup menu after a period of time without pressing any key. The “Manual Exit” means that it needs to exit calibration setup menu manually, while “Auto” means that the display automatically exits the calibration setup menu and goes back to measurement mode after a period of time without pressing any key.

Note: The return functions of setup menu and calibration setup menu are independent settings.

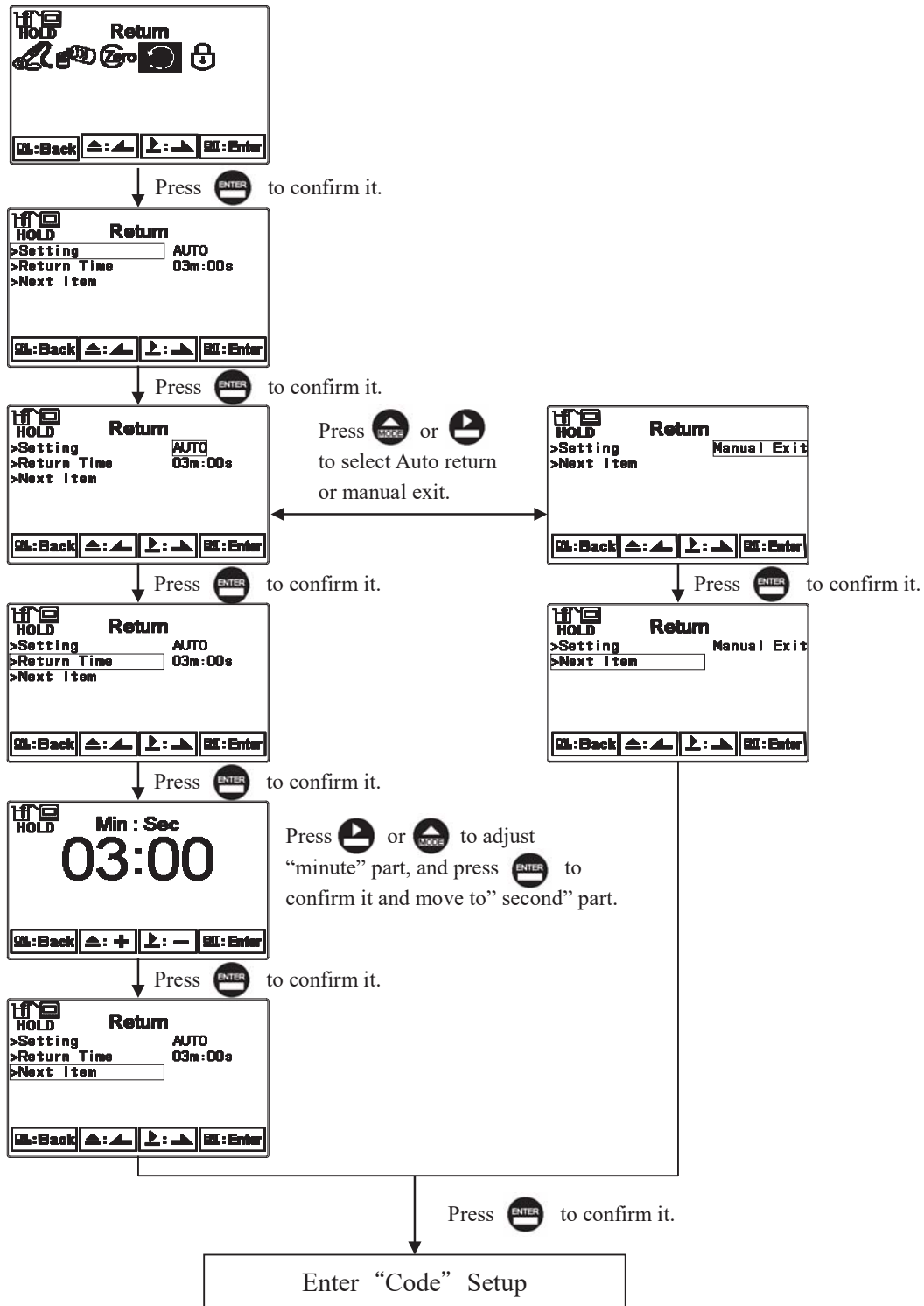

9. Modbus Protocol and Instructions

9.1 Communication connection

The RS-485 communication port of the transmitter EX2000RS features electronic isolation protection, lightning protection, and provides internal independent ground solution. It is allowed to use normal twisted-pair (segregation double-stranded twisted pair cable) cable connections. All devices are in contact with a double-stranded, and then all together, and another line will be connected with all the negative contacts, and the isolated shield wire must be connected to GND. When talking about communication in the laboratory, the stand-alone master-slave communication is relatively simple. Hence, it is allowed to consider using the normal cable instead. However, there should be strictly in accordance with the requirements of industrial engineering construction. Wiring diagram is as follows:

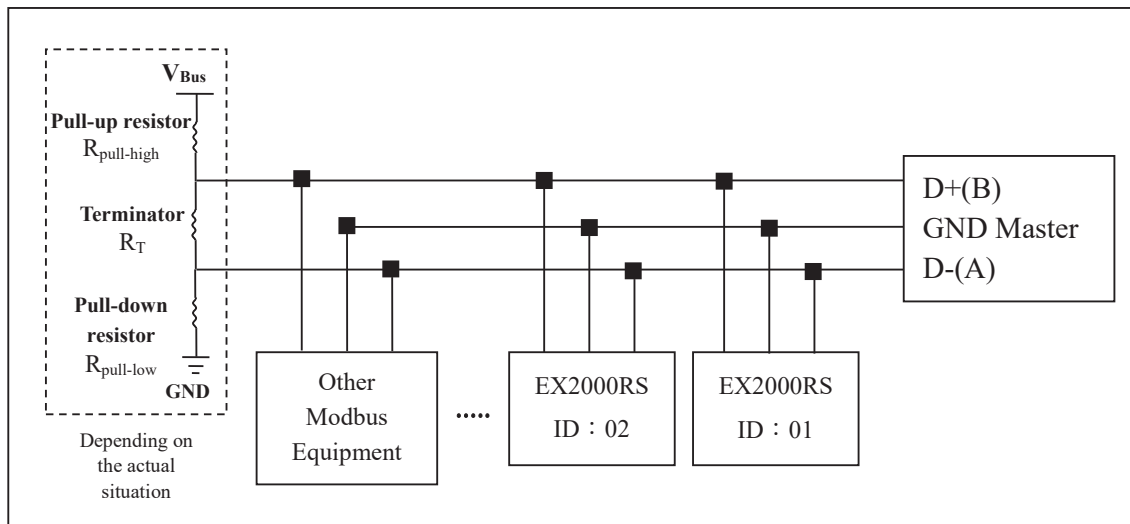

Note:

1. The RS-485 interface of transmitter EX2000RS has a protective earth terminal. When it communicates with the RS-485, there should use with solution ground to eliminate risk of safety.
2. It is allowed to use an 120 ohm impedance matching resistors at terminal equipment across both ends of transmission lines (D +(B), D-(A)) to effectively reduce or eliminate signal reflection.

Note: there are three possible situations resulting in failure connection:

- a. Open circuits: the signal cable has open circuits.
- b. Short circuits: the insulation that is insufficient between signal cables causes short circuits.
- c. Idle-bus: there is no data transmission in the Controlbus.

Based on the previous three situations resulting in unknown state of Controlbus's voltage, the receiver accepts the unexpected signals. Therefore, in some harsh environment like multi-transmitter connection, the Controlbus needs the terminator to avoid reflection of baud rate, and it needs pull-high resistor, pull-low resistor, and biasing circuits made up of V_{Bus} as the block diagrams showing above. Besides, it makes sure that the free voltage between transmission line

D+(B) and D-(A) is available for maintaining the completeness of the signals. Due to not each environment being suitable for fixed resistor and V_{Bus} , as a result, users must pay attention to the settings. Some parts of connecting instruments (as parts of RS-485 or modules) provide the terminator, pull-high resistor, pull-low resistor, and settings of V_{Bus} . Please refer to the operation manuals for the connecting instruments.

3. Without repeaters, the RS-485 network cannot exceed a maximum of 32 nodes. The maximum communication transmission distance of RS-485 is up to 1200 meters. For long distance transmission, it is recommended to apply cables which are dedicatedly design for RS-485.
4. When communication, all the equipments of the network should be maintained in the same transfer mode, baud rate, parity consistent. And each of the device address cannot be the same, so as not to conflict resulted in the normal network communications.
5. The Modbus command of the transmitter EX2000RS can only access 50 registers. If it exceeds the upper limit, then it returns abnormal message.
6. The waiting time which a slave instrument responses to a master machine is different according to each model. Generally, it shall be longer than 0.5 second. (Some models may require a longer waiting-responding time, please note whether it is specified in the operation manual.)

9.2 Modbus Address Table

Modbus response table is as follows. As users communicate with transmitters by PLC or Man-machine Interface, be noted that whether there is a minus 1 situation in actual transmission of address. If so, please be necessary to add 1 in address so that it can match with the table. Example: for the temperature logic address 0037H (16-bit) or 55 (10-bit), if there is a minus 1 output signal proceeded by PLC or Man-machine Interface, then users need to input 0038H(16-bit) or 56(10-bit) first so that it can match with accurate temperature logic address 0037H (16-bit) or 55 (10-bit).

Function Code : 03H, 06, 10H Modbus Response (Setup Parameter)

Logic address	R/W	Item	Number of Byte	Information Type	Description of data transmission	Default Value	Note
0000H		None					
0001H	R	Equipment's ID	2	USHORT	1-247	1	
0002H	R	Transmitter Model	6	USHORT	ASCII Code	EC4110	
0005H	R	Communication Protocol	2	USHORT	0 : RTU 1 : ASCII	0	
0006H	R	Serial Transmission Speed (Baud rate)	2	USHORT	0 : 2400 1 : 4800 2 : 9600 3 : 19200	3	
0007H	R	Parity	2	USHORT	0: None 1: Even 2: Odd	1	
0008H	R/W	Real-time Clock*	12	USHORT	Second	2014-01-01 00 : 00 : 00	
0009H	R/W			USHORT	Minute		
000AH	R/W			USHORT	Hour		
000BH	R/W			USHORT	Day		
000CH	R/W			USHORT	Month		
000DH	R/W			USHORT	Year		
000EH	R/W	Code Setting*	2	USHORT	Code setting	1111	
000FH	R/W	Temperature Mode*	2	USHORT	0 : MTC 1 : PTC1000 2 : NTC 3 : PTC100	1	
0010H	R/W	Clean Relay*	2	USHORT	0 : OFF 1 : AUTO	0	
0011H	R/W		2	USHORT	ON.S : 0-5999	0	Second
0012H	R/W		2	USHORT	OFF.H : 0-999	0	Hour

0013H	R/W		2	USHORT	OFF.M : 0-59	0	Minute		
0014H	R/W		2	USHORT	Hys.S : 0-5999	0	Second		
0015H	R/W	Relay 1*	2	USHORT	0 : OFF 1 : AUTO	1			
0016H	R/W		2	USHORT	0 : Hi 1 : Lo	0			
0017H	R/W		4	FLOAT	SP1	1000mS/cm	Data affected by sign		
0019H	R/W		4	FLOAT	Hys1	10mS/cm			
001BH	R/W		Relay2*	2	USHORT	0 : OFF 1 : AUTO	1		
001CH	R/W	2		USHORT	0 : Hi 1 : Lo	1			
001DH	R/W	4		FLOAT	SP2	100.0mS/cm	Data affected by sign		
001FH	R/W	4		FLOAT	Hys2	1.0mS/cm			
0021H	R/W	Backlight Brightness*	2	USHORT	0 : AUTO 1 : ON 2 : OFF	2			
0022H	R/W		2	SHORT	2: Highest brightness 1: high brightness 0: Standard -1: Low brightness -2: Lowest brightness	0			
0023H	R/W		Backlight Sensitivity*	2	SHORT	2: Highest Sensitivity 1: High Sensitivity 0: Standard -1: Low Sensitivity -2: Lowest Sensitivity	0		
0024H	R/W			Sample Average of Measurements (Digital Filter) *	2	USHORT	0-60	0	
0025H	R/W			Product Adjustment*	2	USHORT	0 : OFF 1 : ON	0	
0026H		4			FLOAT	0.7000~1.3000	1.0000		
0028H	R/W	Event Serial Number	2	USHORT	1~50	1			
0029H	R	Event Time	12	USHORT	Second	2014-01-01 00 : 00 : 00			
002AH	R			USHORT	Minute				
002BH	R			USHORT	Hour				

002CH	R			USHORT	Day		
002DH	R			USHORT	Month		
002EH	R			USHORT	Year		
002FH	R	Event Code	2	USHORT	0~13	0	
0030H	Factory reserved						

Note 1: The actions without * sign only support for function code 03H. The actions with * sign support function code 03H, 06H, 10H.

Note 2: EC-4110-I's FLOAT is a 32-bit IEEE 754 format. The above table, for an example, is divided into two 16-bit register data transmission. The back 16-bit register(CC CD) will be transferred first, and then the first 16-bit register (41 C8) will be transferred later. Every 16-bit format is high-bit in the front and low-bit in the post. For example, the temperature now is 25.1°C. The 16-bit of FLOAT data(Hexadecimal) will show 41 C8 CC CD. The transmission order is CC CD 41 C8. For detail descriptions, please refer to ch9.3 Modbus Example Description.

Note 3: USHORT represents unsigned short integer.

Note 4: Logbook Event Code

Event	Description	Modbus code
Mea mode	Measurement mode	00
Set mode	Setting mode	01
Cal mode	calibration mode	02
Power On	The unit is powered up	03
Power Off	The unit is out of power	04
Cond_mA Over	Current is over range (Conductivity mode)	05
Error 1	Unstable reading during calibration	06
Error 2	1. Cell factor exceeds the upper/lower limit 2. Temperature is over range	07
Error 3	Wrong password	08
Conc_mA Over	Current is over range (Concentration mode)	09
Error 9	The unit is broken	10
Modbus Write	Modbus input action	13

Note 5: Main measurement item code

Main item	Description	Modbus code
Cond.@tx	Absolute conductivity measurement mode	01
Cond.@tref	Temperature compensated conductivity measurement mode	02
Salinity	Salinity measurement mode	03
TDS	Total dissolved solids measurement mode	04

NaCl_28%	Sodium chloride solution 0~28%	05
HCl_18%	Hydrochloric acid solution 0~18%	06
HCl_39%	Hydrochloric acid solution 22~39%	07
HNO ₃ _30%	Nitric acid 0~30%	08
HNO ₃ _96%	Nitric acid 35~96%	09
NaOH_24%	Sodium hydroxide solution 0~24%	10
NaOH_50%	Sodium hydroxide solution 15~50%	11
H ₂ SO ₄ _37%	Sulfuric acid 0~37%	12
H ₂ SO ₄ _88%	Sulfuric acid 28~88%	13
H ₂ SO ₄ _99%	Sulfuric acid 89~99%	14
H ₃ PO ₄ _35%	Phosphoric acid 0~35%	15
Defined	User defined concentration table	16

Function Code: 03H Modbus Response (Measurement Parameter)

Logic address	R/W	Item	Number of Byte	Information type	Description of data transmission	Default value	Note
0031H	R	Measurement Status	2	USHORT	0 : Hold 1 : Measurement	1	
0032H	R	Sign	6	CHAR	μS/cm mS/cm % ppm ppt	Cond.@tref 2000mS/cm	ASCII Code
0035H	R	Cond./Conc./ TDS/Salinity Measurement	4	FLOAT	Cond./Conc./ TDS/Salinity Measurement		
0037H	R	Temperature Measurement	4	FLOAT	Temperature Measurement		
0039H- 003FH	Factory reserved						
0040H	R	Cell Constant	4	FLOAT	Cell Constant	2.700	
0042H	R	Calibration Time	2	USHORT	Minute	2014-01-01 00 : 00	
0043H	R		2	USHORT	Hour		
0044H	R		2	USHORT	Day		
0045H	R		2	USHORT	Month		
0046H	R		2	USHORT	Year		
0047H- 0050H	Factory reserved						

Function Code: 01H & 05H Modbus Response (Dispersion Parameter)

Logic address	R/W	Item	BIT	Description	Default value	Note
0070H	R	LO Alarm	1	Contact on	0 (Contact off)	
0071H	R	Hi Alarm	1	Contact on	0 (Contact off)	
0072H	R	MA Too High	1	Contact on	0 (Contact off)	
0073H	R	MATtoo Low	1	Contact on	0 (Contact off)	
0074H	R	Exceed Temp. Range	1	Contact on	0 (Contact off)	
0075H	R	Exceed Measuring Range	1	Contact on	0 (Contact off)	
0076H	R	RLY1 Action	1	Contact on	0 (Contact off)	
0077H	R	RLY2 Action	1	Contact on	0 (Contact off)	
0078H	R	Clean Action	1	Contact on	0 (Contact off)	
0079H-008FH	Factory reserved					

9.3 Modbus Example Descriptions(ex: function code 03H)

The following description takes the temperature reading(0037H) as an example. Set the temperature at the transmitter at MTC 25.1°C, and confirm that host and sub-machine communication format settings are correct. The host according to the following left table to send commands, and then to get the response from sub-machine according to following right table. This example shows the message transmission function code 03H data format. If under other function code, the logic mode can be analogized.

ASCII Mode:

Request		Response	
Message Framing	Hex	Message Framing	Hex
ID, Address	01	ID, Address	01
Function code	03	Function code	03
Starting Address Hi	00	Byte Count	04
Starting Address Lo	37	Register value Hi	CC
No. of Registers Hi	00	Register value Lo	CD
No. of Registers Lo	02	Register value Hi	41
LRC	C3	Register value Lo	C8
		LRC	56

RTU Mode:

Request		Response	
Message Framing	Hex	Message Framing	Hex
ID, Address	01	ID, Address	01
Function code	03	Function code	03
Starting Address Hi	00	Byte Count	04
Starting Address Lo	37	Register value Hi	CC
No. of Registers Hi	00	Register value Lo	CD
No. of Registers Lo	02	Register value Hi	41
CRC Check Lo	75	Register value Lo	C8
CRC Check Hi)	C5	CRC Check Lo	65
		CRC Check Hi	5A

Note: FLOAT is a 32-bit IEEE 754 format. The above table, for an example, is divided into two 16-bit register data transmission. The back 16-bit register(CC CD) will be transferred first, and then the first 16-bit register (41 C8) will be transferred later. Every 16-bit format is high-bit in the front and low-bit in the post. For example, the temperature now is 25.1°C. The 16-bit of FLOAT data(Hexadecimal) will show 41 C8 CC CD. The transmission order is CC CD 41 C8.

10. Error Messages (Error Code)

Messages	Reason	Dispositions
Error1	The readout is unstable when calibration	<ol style="list-style-type: none">1. Replace with new standard solution2. Maintain the electrode or replace a new electrode, and make another calibration
Error2	<ol style="list-style-type: none">1. Cell constant of the electrode exceeds the upper or lower limit2. Exceeds temperature range	<ol style="list-style-type: none">1. Replace with new standard solution1. Maintain the electrode or replace a new electrode, and make another calibration
Error3	Wrong password ERROR CODE	Re-enter a password
Error5	Serious error that does not permit any further measuring	Please call service engineer.

Appendix: Calibration Solution

Potassium chloride solution

Conductivity in mS/cm

°C	Conductivity	1.413mS/cm@25°C	12.88mS/cm@25°C	111.8mS/cm@25°C
	Concentration	0.01mol/l	0.1mol/l	1mol/l
0		0.776	7.15	65.41
5		0.896	8.22	74.14
10		1.020	9.33	83.19
15		1.147	10.48	95.52
16		1.173	10.72	94.41
17		1.199	10.95	96.31
18		1.225	11.19	98.22
19		1.251	11.43	100.14
20		1.278	11.67	102.07
21		1.305	11.91	104
22		1.332	12.15	105.94
23		1.359	12.39	107.89
24		1.386	12.64	109.84
25		1.413	12.88	111.8
26		1.441	13.13	113.77
27		1.468	13.37	115.74
28		1.496	13.62	
29		1.524	13.87	
30		1.552	14.12	
31		1.581	14.37	
32		1.609	14.62	
33		1.638	14.88	
34		1.667	15.13	
35		1.696	15.39	
36			15.64	

Sodium chloride solution

Conductivity in mS/cm

°C	Conductivity	10.683mS/cm@25°C	251.3mS/cm@25°C
	Concentration	0.1mol/l	saturated
0		5.786	134.5
1		5.965	138.6
2		6.145	142.7
3		6.327	146.9
4		6.510	151.2
5		6.695	155.5
6		6.881	159.9
7		7.068	164.3
8		7.257	168.8
9		7.447	173.4
10		7.638	177.9
11		7.831	182.6
12		8.025	187.2
13		8.221	191.9
14		8.418	196.7
15		8.617	201.5
16		8.816	206.3
17		9.018	211.2
18		9.221	216.1
19		9.425	221.0
20		9.631	226.0
21		9.838	231.0
22		10.047	236.1
23		10.258	241.1
24		10.469	246.2
25		10.683	251.3
26		10.898	256.5
27		11.114	261.6
28		11.332	266.9
29		11.552	272.1
30		11.773	277.4

31	11.995	282.7
32	12.220	288
33	12.445	293.3
34	12.673	298.7
35	12.902	304.1
36	13.132	309.5