

TX3100

Microprocessor

pH/ORP

Transmitter

Operation
Manual

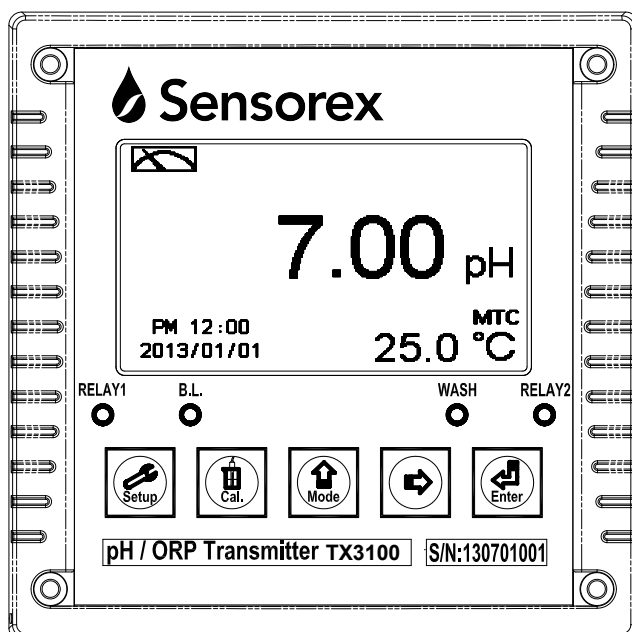

CONTENTS



Precautions for Installation

Brief Instructions	4
1. Specifications	7
2. Assembly and Installation	
2.1 Transmitter Installation	8
2.2 Panel Mounting Illustration	8
2.3 Wall Mounting and Pipe Mounting Illustration	9
2.4 Electrode and Housing Assembly	10
2.5 Round Junction Box Illustration and Description.....	13
2.6 Rectangular Junction Box Illustration and Description.....	16
3. Overview of pH/ORP Transmitter TX3100	
3.1 Rear Panel Illustration	19
3.2 Terminal Function Illustration	19
3.3 Terminal Function Description	20
3.4 Accessorial Transmitter PH-300T Installation (Optional).....	21
3.5 Transmitter and Accessorial Transmitter PH-300T Connection	22
3.6 Wiring Illustration.....	23
3.7 Electrical Connection Illustration	24
3.8 Online pH/ORP Measurement System (Optional).....	25
4. Configuration	
4.1 Front Panel Illustration	26
4.2 Keypad	26
4.3 LED Indicators.....	26
4.4 Display.....	27
5. Operation	
5.1 Measurement Mode	28
5.2 Settings Menu	28
5.3 Calibration Menu	28
5.4 Shortcuts	28
5.5 Default Values.....	28
6. Settings	
Settings Block Diagram	30
6.1 Settings Menu	32
6.2 Settings Security Code (Code).....	33
6.3 Language.....	34
6.4 Measurement Parameter (Mode)	35









6.5 Multi-Point Calibration (Multi-Cal)	36
6.6 Temperature	37
6.7 Relay 1	38
6.8 Relay 2	39
6.9 Clean	40
6.10 Analog Output 1 (pH/ORP)	41
6.11 Analog Output 2 (Temperature)	42
6.12 Date/Time (Clock)	43
6.13 Sample Measurement Average (Digital Filter)	44
6.14 Back Light.....	45
6.15 Contrast.....	46
6.16 Automatic Return (Return)	47
7. Calibration	
Calibration Block Diagram.....	48
7.1 Calibration Menu	49
7.2 Calibration Security Code (Code).....	50
7.3 pH Calibration.....	51
7.4 ORP Calibration.....	55
7.5 Automatic Return (Return)	56
8. Error Messages (Error Codes).....	57
9. Maintenance	58
Appendix.....	59

Brief Instructions



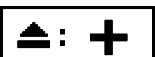

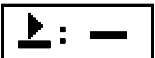
◎ Settings Menu Description (See Chapter 6 for Details)





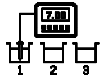



Press  and  simultaneously to display settings information overview. Press  to enter settings menu. Press keypad according to the index bar at the bottom of the screen.

Keypad Index



Keypad	Index Bar	Description
		Return to previous level or action
		Left or left page
		Increase digit
		Right or right page
		Decrease digit
		Confirm and proceed to next step

Settings Items







Function	Icon	Description
Mode		Measurement mode, select pH or ORP measurement
Multi-Cal.		Multi-point calibration, adjust number of points (PC-3310 provides up to three point calibration)
Temperature		Temperature measurement and compensation, MTC - Manual temperature compensation PTC/NTC - Auto temperature compensation
Relay 1		First relay settings, select Hi/Lo alarm or OFF
Relay 2		Second relay settings, select Hi/Lo alarm or OFF
Clean		Automatic wash time settings Set cleaning relay ON/OFF duration

Analog 1		Current output corresponding to pH or ORP range
Analog 2		Current output corresponding to temperature range
Clock		Time and date settings
Digital Filter		Digital filter settings, adjust number of samples to be averaged for each reading
Back Light		Backlight settings, set backlight Auto/ON/OFF, brightness, and sensitivity
Contrast		Screen contrast settings
Return		Measurement mode return settings
Code		Settings passcode setup, the settings passcode is precedential to the calibration passcode and can be used to bypass calibration lock
Language		Available in English, Traditional Chinese, and Simplified Chinese

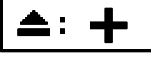

◎ Calibration Menu Description (See Chapter 7 for Details)

Press  and  simultaneously to display calibration information overview. Press  to enter calibration menu. Press keypad according to the index bar at the bottom of the screen.

Keypad Index:

Keypad	Accordingly item	Description
	CAL:Back	Return to previous level or action
		Left or left page
		Increase digit
		Right or right page
		Decrease digit
	ENT:Enter	Confirm and proceed to next step

Calibration Items:

Function	Icon	Description
TECH	TECH	Use TECH buffers as standard solution for calibration
NIST	NIST	Use NIST standard buffers (DIN 19266) as standard solution for calibration
Any	Any	Use any buffer solution by users' definition for calibration
Return		Measurement mode return settings
Code		Calibration passcode setup

1. Specifications

Model		TX3100
Measurement Modes		pH/ORP/Temp
Range	pH	-2.00~16.00 pH
	ORP	-1999~1999 mV
	TEMP	-30.0~130.0°C
Resolution	pH	0.01 pH
	ORP	1 mV
	TEMP	0.1°C
Accuracy	pH	±0.01 pH (±1 Digit)
	ORP	±0.1% (±1 Digit)
	TEMP	±0.2°C (±1 Digit) with temperature error correction
Temperature Compensation		NTC30K / PT1K Auto temperature compensation Manual temperature compensation
Calibration Mode		TECH, NIST, Any Buffer, up to three point calibration
Ambient Temp.		0~50°C
Storage Temp.		-20~70°C
Input Impedance		> 10 ¹² Ω
Display		Large LCM with backlight sensor and contrast adjustment; Text mode
Language		Available in English, Traditional Chinese, Simplified Chinese
Analog Output 1		Isolated DC 0/4~20 mA corresponding to main measurement, Max load 500Ω
Analog Output 2		Isolated DC 0/4~20mA corresponding to temperature, Max load 500Ω
Settings	Contact	RELAY ON/OFF contact, 240VAC 0.5A Max (recommended)
	Activate	Hi/Lo, Hi/Hi, Lo/Lo, selectable two limited programmable, ON/OFF
Wash		RELAY contact, ON 0~99 min 59 sec / OFF 0~999 hr 59 min
Voltage Output		DC±12V, 1W Max for PH-300T (Optional)
Protection		IP65
Power Supply		100V~240VAC±10%, 6W Max, 50/60Hz
Installation		Wall / Pipe / Panel Mounting
Dimensions		144 mm × 144 mm × 115 mm (H×W×D)
Cut off Dimensions		138 mm × 138 mm (H×W)
Weight		0.8 kg

2. Assembly and Installation

2.1 Transmitter Installation

This transmitter can be installed by panel mounting, wall mounting, or 2" pipe mounting.

Panel Mounting:

Prepare a square hole of 138 mm x 138 mm on the panel box, then insert the controller directly into the hole. Insert the accessorial mounting bracket from the rear, and fix into the pickup groove.

2.2 Panel Mounting Illustration

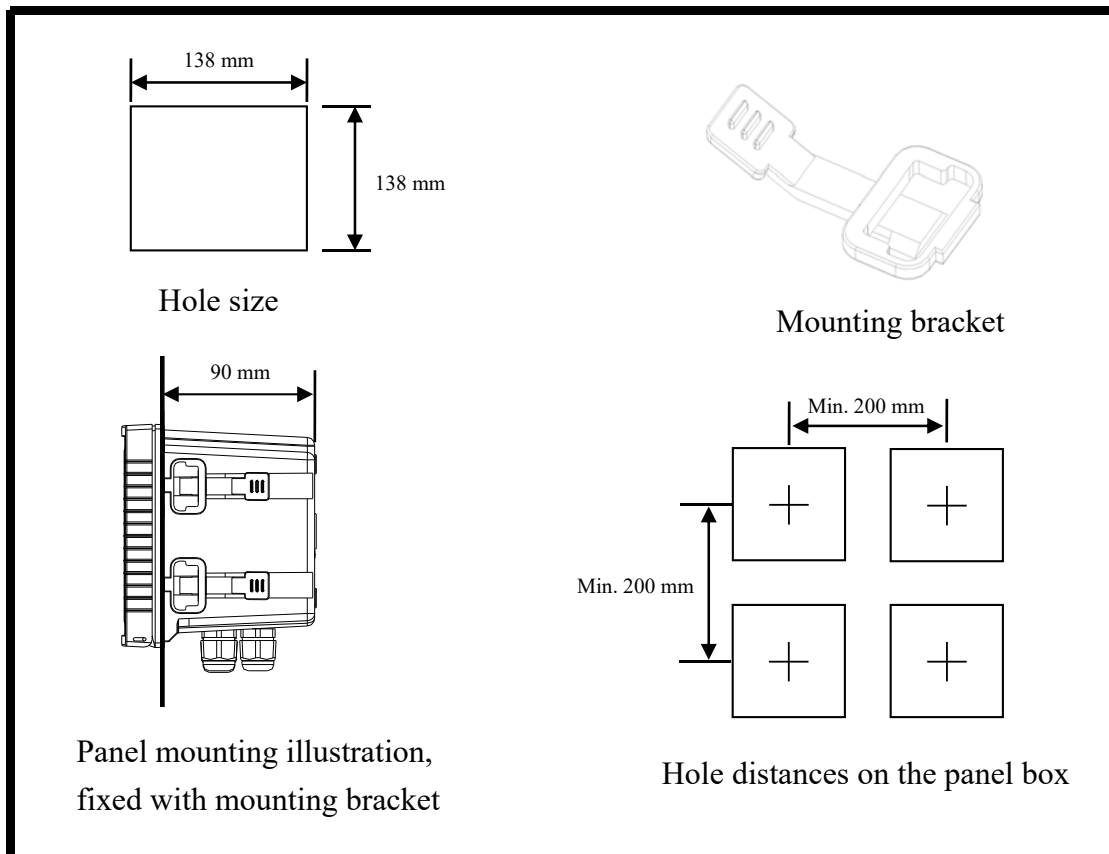

2.4 Electrode and Housing Assembly

2.4.1 Cable Preparation (Cable Stripping Procedure)

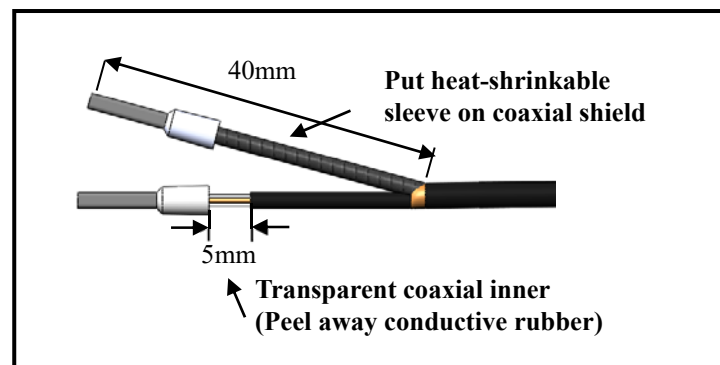

pH/ORP Cable Preparation

pH/ORP Signal Cable Preparation Instruction:

Refer to the cable preparation illustration above. Peel 5 mm of the black conductive rubber wrap on the coaxial inner away from the connection tip.

The length of the separated coaxial inner and coaxial shield wires is suggested to be approx. 40 mm for the convenience of wiring.

- Strip off approximately 40 mm of the pH/ORP coaxial cable jacket; separate the coaxial inner wire and coaxial shield wire as seen in the illustration above.
- Make sure to remove the conductive rubber of the coaxial inner as seen in the following illustration.

Coaxial Inner Stripping Illustration

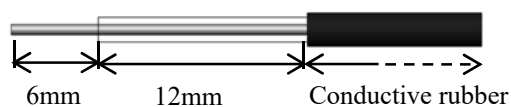

- Put heat-shrinkable sleeve on the coaxial shield.
- Attach connection tips on both ends of coaxial inner and coaxial shield.
- Extend the cable to the transmitter without any joints except at the junction box. Connect the transparent coaxial inner directly to the GLASS terminal on the back of transmitter, then connect the metal coaxial shield to the REF terminal.

3. Overview of pH/ORP Transmitter TX3100

3.1 Rear Panel Illustration

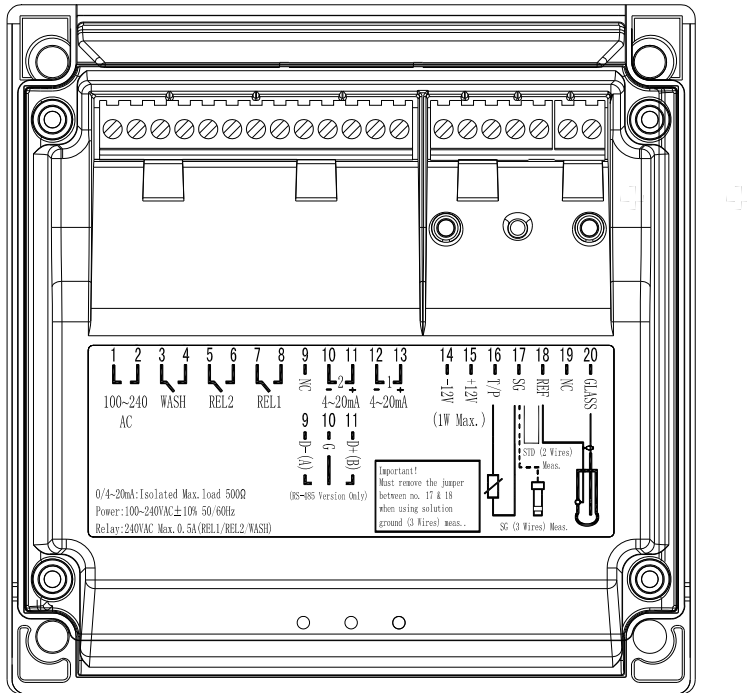

3.2 Terminal Function Illustration

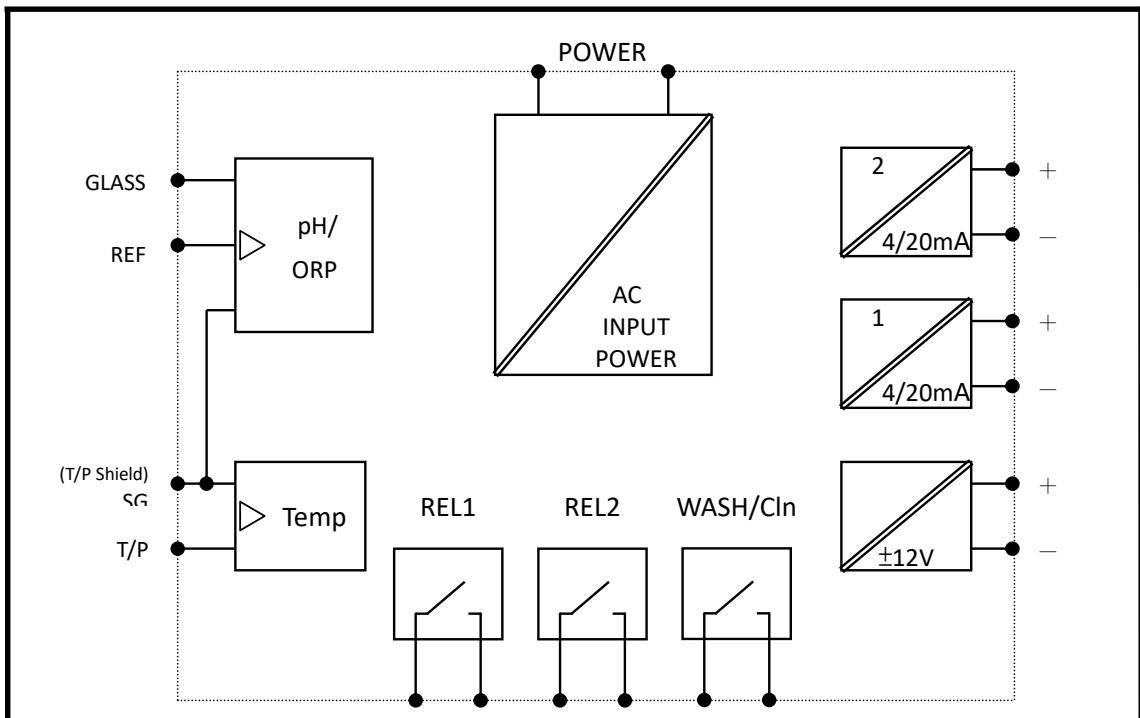

3.3 Terminal Function Description

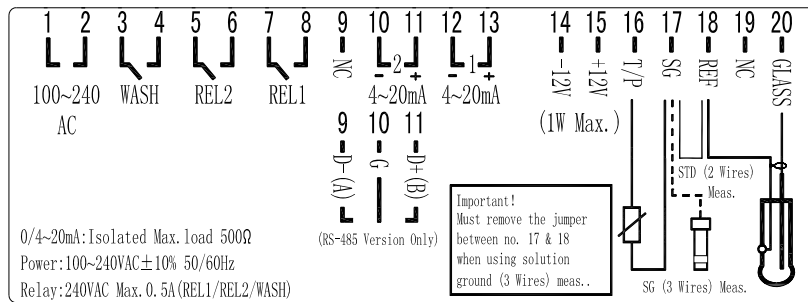

- 1 ┌───┐ ─────────── **100~240 AC:** Power supply terminal
- 2 └───┘
- 3 ┌───┐ ─────────── **WASH:** Wash relay contact for an external relay
- 4 └───┘
- 5 ┌───┐ ─────────── **REL2:** Second alarm control, contact for an external relay
- 6 └───┘
- 7 ┌───┐ ─────────── **REL1:** First alarm control, contact for an external relay
- 8 └───┘
- 9 ─────────── **NC / D-(A):** No contact
- 10 ─────────── **4~20mA - terminal / G:** Temperature current output terminal -, for external recorder or PLC control
- 11 ─────────── **4~20mA + terminal / D+(B):** Temperature current output terminal +, for external recorder or PLC control
- 12 ─────────── **4~20mA - terminal:** Master measure current output terminal -, for external recorder or PLC control
- 13 ─────────── **4~20mA + terminal:** Master measure current output terminal +, for external recorder or PLC control
- 14 ┌───┐ ─────────── **DC±12V:** Output terminal of direct current voltage ±12V
- 15 └───┘
- 16 ─────────── **T/P:** Connect with one of cable end of temperature probe
- 17 ─────────── **SG:** Solution ground wire. **In a two-wire distribution system, the terminals SG and REF should be short circuited with a terminal cross jumper slice (included and attached as factory default).**
- 18 ─────────── **REF:** Coaxial shield of pH/ORP electrode signal wire
- 19 ─────────── **NC:** No contact
- 20 ─────────── **GLASS:** Coaxial inner of pH/ORP electrode signal wire

3.6 Wiring Illustration

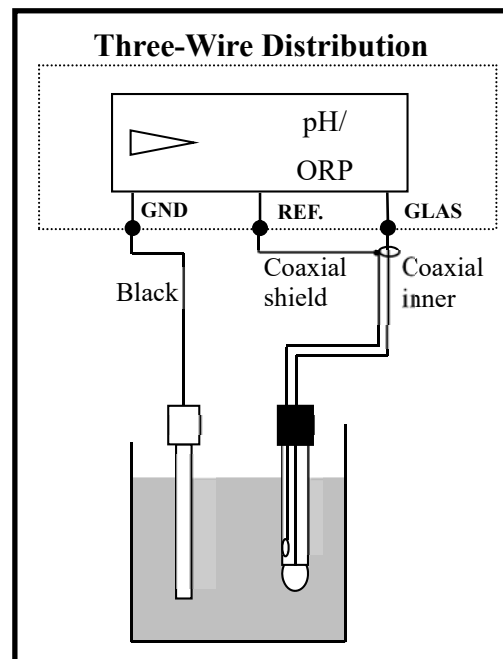
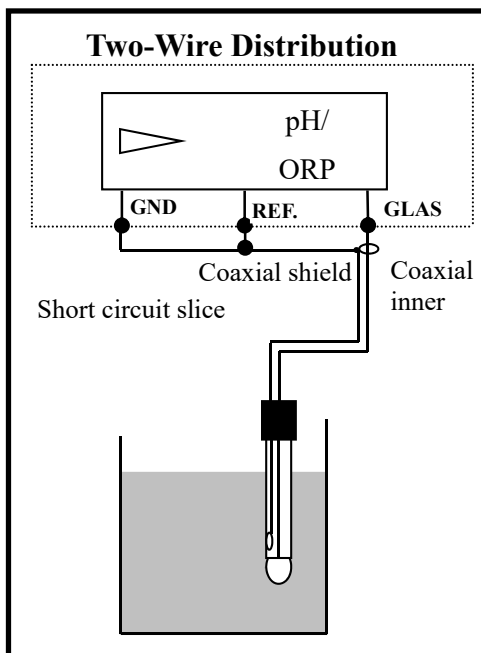

3.7 Electrical Connection Illustration

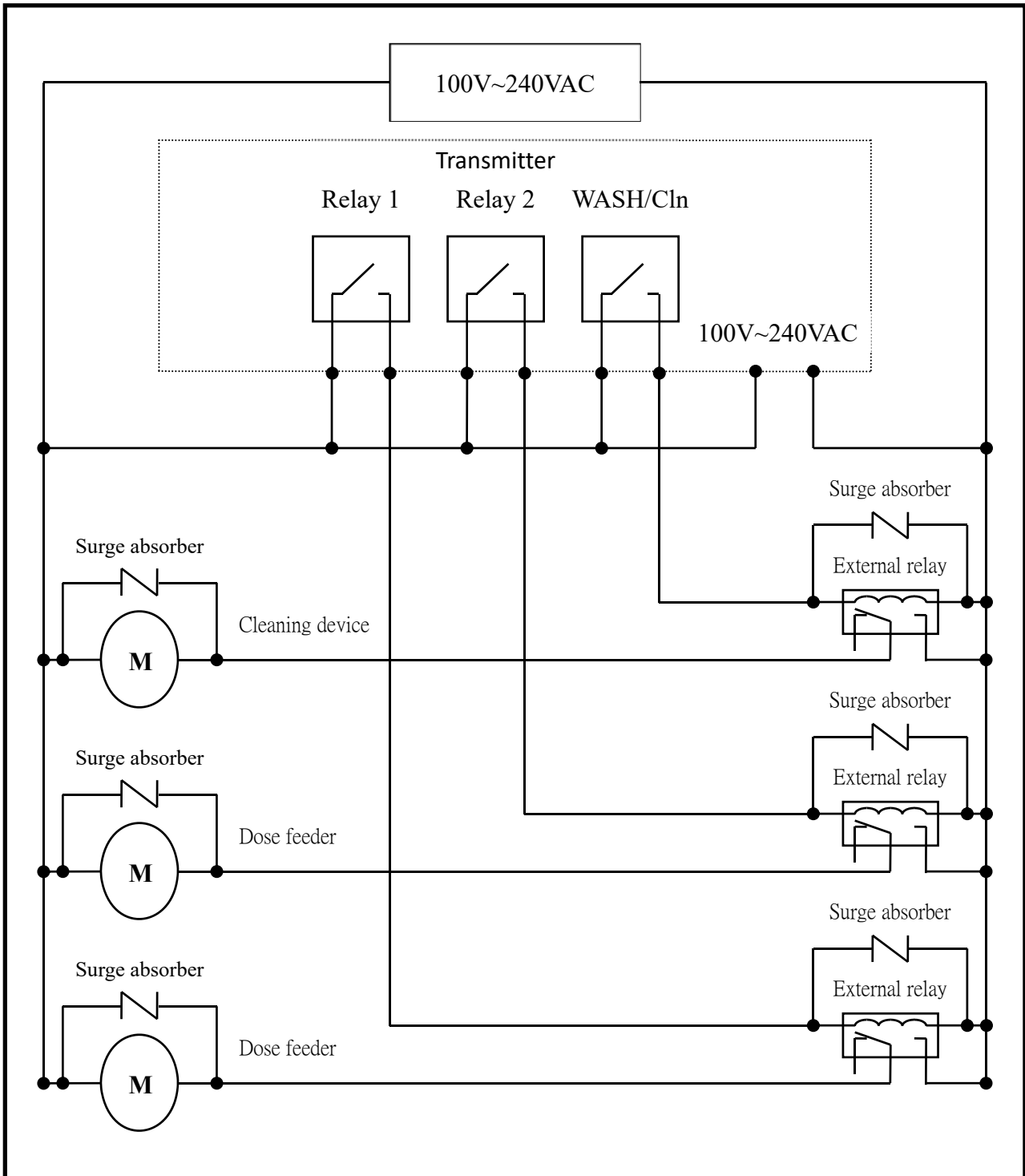

Note: The transmitter's built-in miniature relays are required to be repaired and replaced by professional technicians. **External relays** (Power Relay) must be connected to activate external devices.

4. Configuration

4.1 Front Panel Illustration

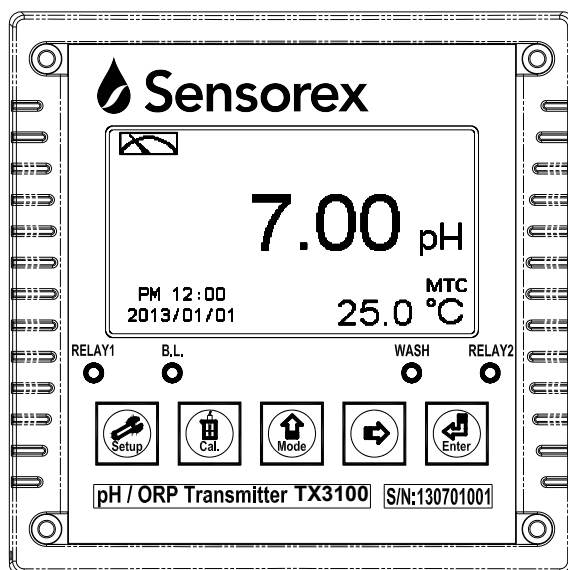

4.2 Keypad

In order to prevent unauthorized operations, the transmitter utilizes multi-key and passcode functions to enter parameter and calibration setting modes. Description of the key functions are as follows:



: When in settings menu, press this key to exit and return to measurement mode.

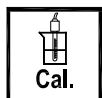

: When in calibration menu, press this key to exit and return to measurement mode.

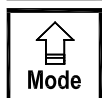

1. When in settings or calibration menu, press this key to move left or return to the previous page.
2. When adjusting values, press this key to increase the digit.

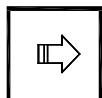

1. When in settings or calibration menu, press this key to move right or to advance to the next page.
2. When adjusting values, press this key to decrease the digit.



: Key for confirmation; press this key to confirm data values or select menu items.

4.3 LED Indicators

WASH : Washing device operation indicator

RELAY1: Dosage control operation indicator (Relay 1)

RELAY2: Dosage control operation indicator (Relay 2)

B.L. : Light sensor; under automatic display backlight mode, the indicator will light up when the surrounding brightness changes.

4.4 Display

1. When clean function is activated, the display will show “HOLD” and flash “Clean Running”. At the same time, the WASH indicator LED will light up, and the transmitter will automatically turn off Relay 1 and Relay 2 function. After cleaning is completed, both Relay 1 and Relay 2 will automatically return.
2. When Relay 1/Relay 2 Hi settings are activated, the display will flash “REL1-HI/ REL2-HI”, and the RELAY1/RELAY2 indicator LED will light up. When Relay 1/Relay 2 Lo settings are activated, the display will flash “REL 1-Lo/ REL 2-Lo”, and the RELAY1/RELAY2 indicator LED will light up.
3. When the Analog 1 current output exceeds the upper/lower limit, the display will flash “pH-mA ▲ / pH-mA ▼” or “ORP-mA ▲ / ORP-mA ▼”.
4. When the Analog 2 current output exceeds the upper / lower limit, the display will flash “°C-mA ▲ / ▲ °C -mA ▼”.

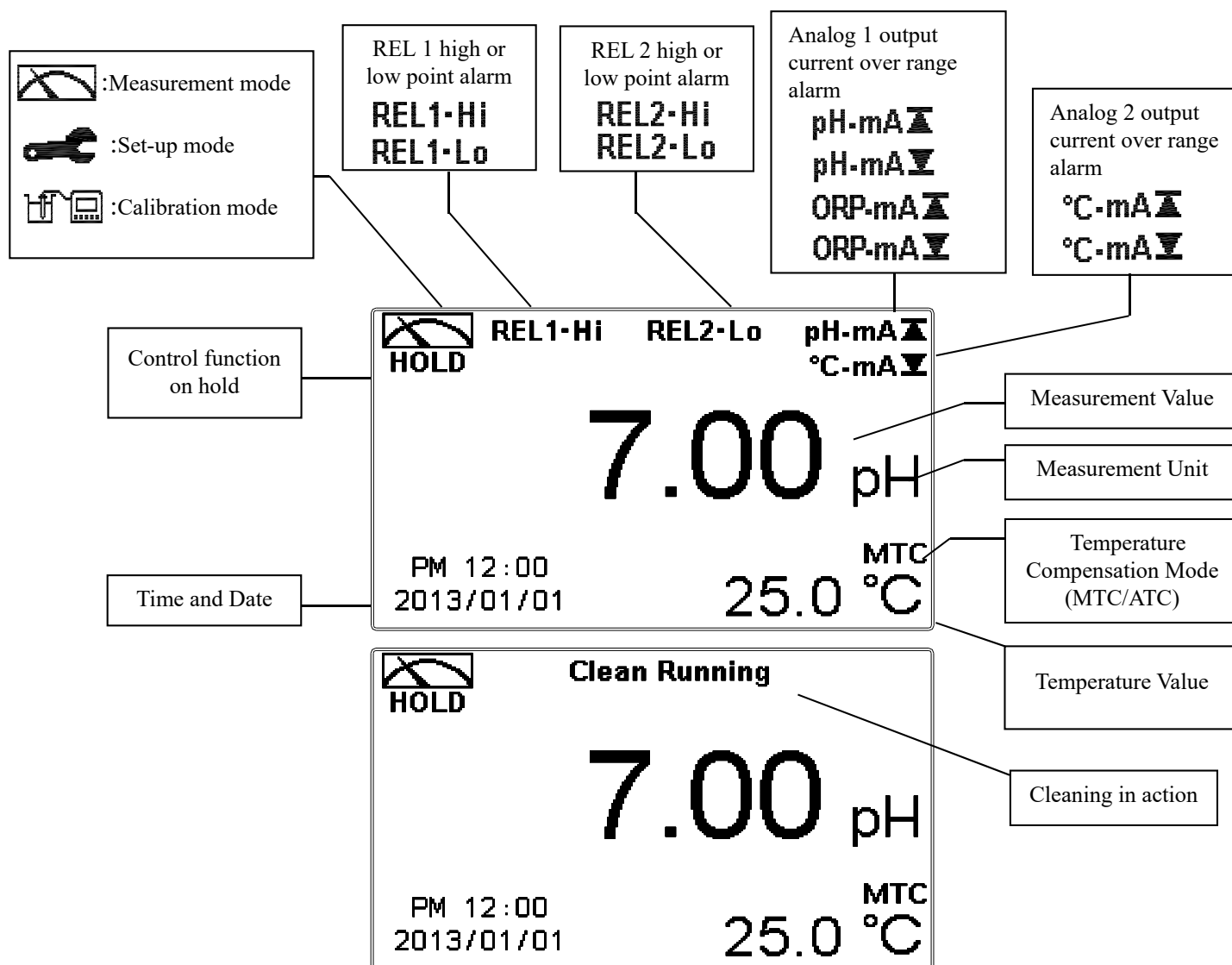

Note: The “HOLD” warning text appears when clean function is activated, or when entering setup menu, or when entering calibration menu. Under HOLD status, the corresponding display and output are as follows:



1. Both Relay 1 and Relay 2 cease from action. When entering settings menu or calibration menu under clean status, the instrument will pause cleaning automatically.
2. The current output which corresponds to measurement value, will remain at the last output value before HOLD status.

5. Operation



5.1 Measurement Mode

After all electrical connections are secured and tested, connect the instrument to the power supply to turn it on. The transmitter will automatically enter measurement mode with the factory default settings or the previous user settings.



5.2 Settings Menu

Please refer to the settings instructions in Chapter 6. Press  and  simultaneously to enter settings menu, or press  to return to measurement mode.

5.3 Calibration Menu

Please refer to the calibration instructions in Chapter 7. Press  and  simultaneously to enter calibration menu, or press  to return to measurement mode.

5.4 Shortcuts

Under measurement mode, if MTC is selected for temperature compensation mode, you may press  or  to adjust the MTC temperature value.

5.5 Default Values:

5.5.1 Settings Default Values

Measurement Mode: pH

Multi-Cal: 2 points

Temperature Compensation: MTC 25°C

Relay 1: High point alarm: AUTO, SP1 = 10.00 pH, Hys = 0.10 pH

Relay 2: Low point alarm: AUTO, SP2 = 4.00 pH, Hys = 0.10 pH

Wash Time: OFF

Analog 1 current output (pH/ORP): 4~20 mA, 0.00~14.00 pH

Analog 2 current output (Temp): 4~20 mA, 0~100.0°C

Date & Time: 2013/1/1 00:00:00

Digital Filter: 5

Backlight: Off

Contrast: 0

Return: Auto, 3 minutes

Code: OFF

5.5.2 Calibration Default Values:

Calibration Type: TECH-No Cal
Slope: -59.15 mV/pH @ 25.0°C
Asy: 0 mV
Sensitivity: 100.0%
Determination:1.0000
Calibration Value: None data
Return: Auto, 3 minutes
Codep: OFF

Note: The factory default calibration setting is “No Cal”, and the calibration value is “None”. This means that the user has not yet calibrated the sensor with the transmitter. After every calibration, the display will show the calibration type and the calibration value. However, if the transmitter has not yet been calibrated, it takes the pre-set Asy and Slope into measurement.

6. Settings



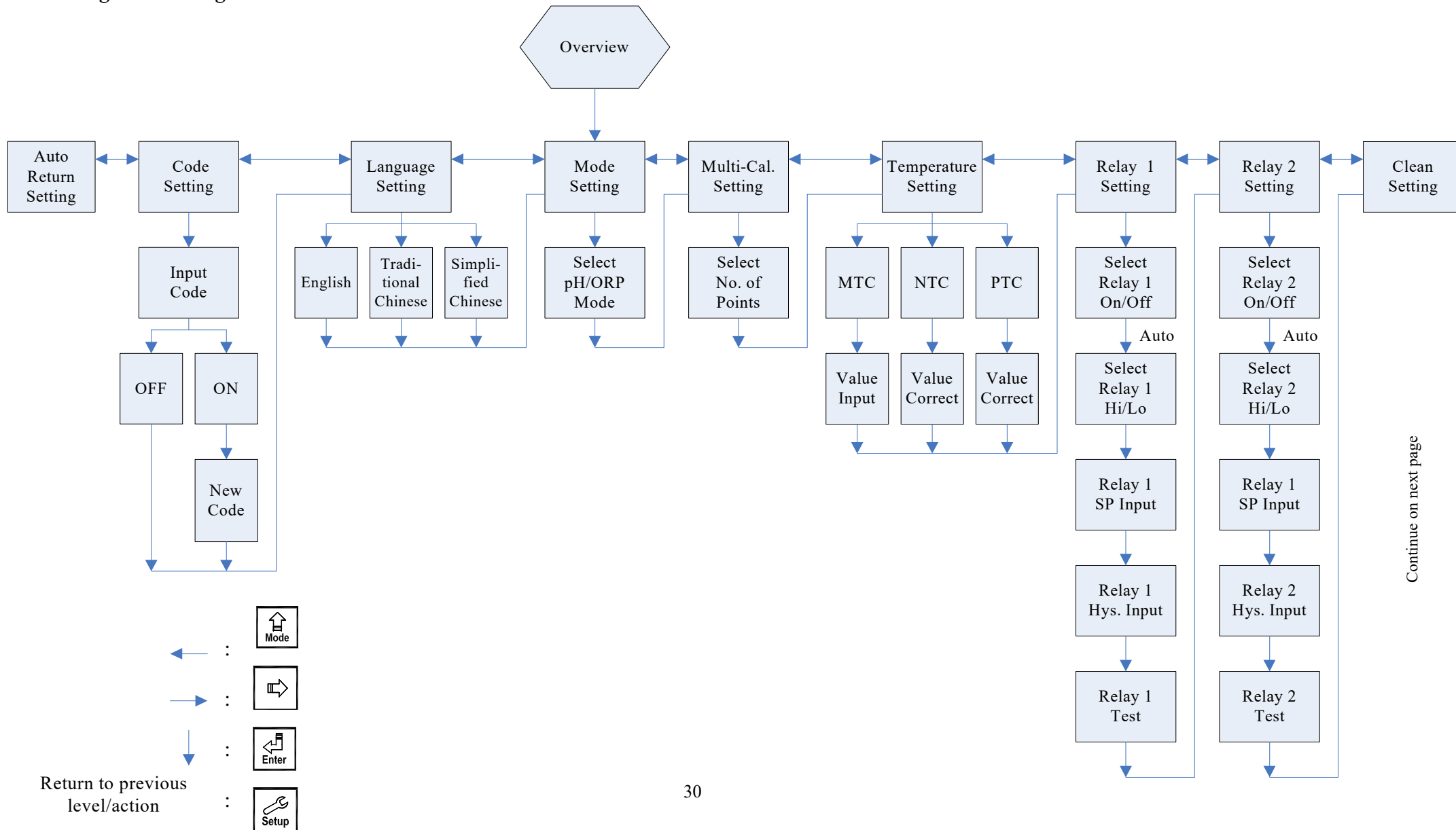

Settings Block Diagram - Part 1

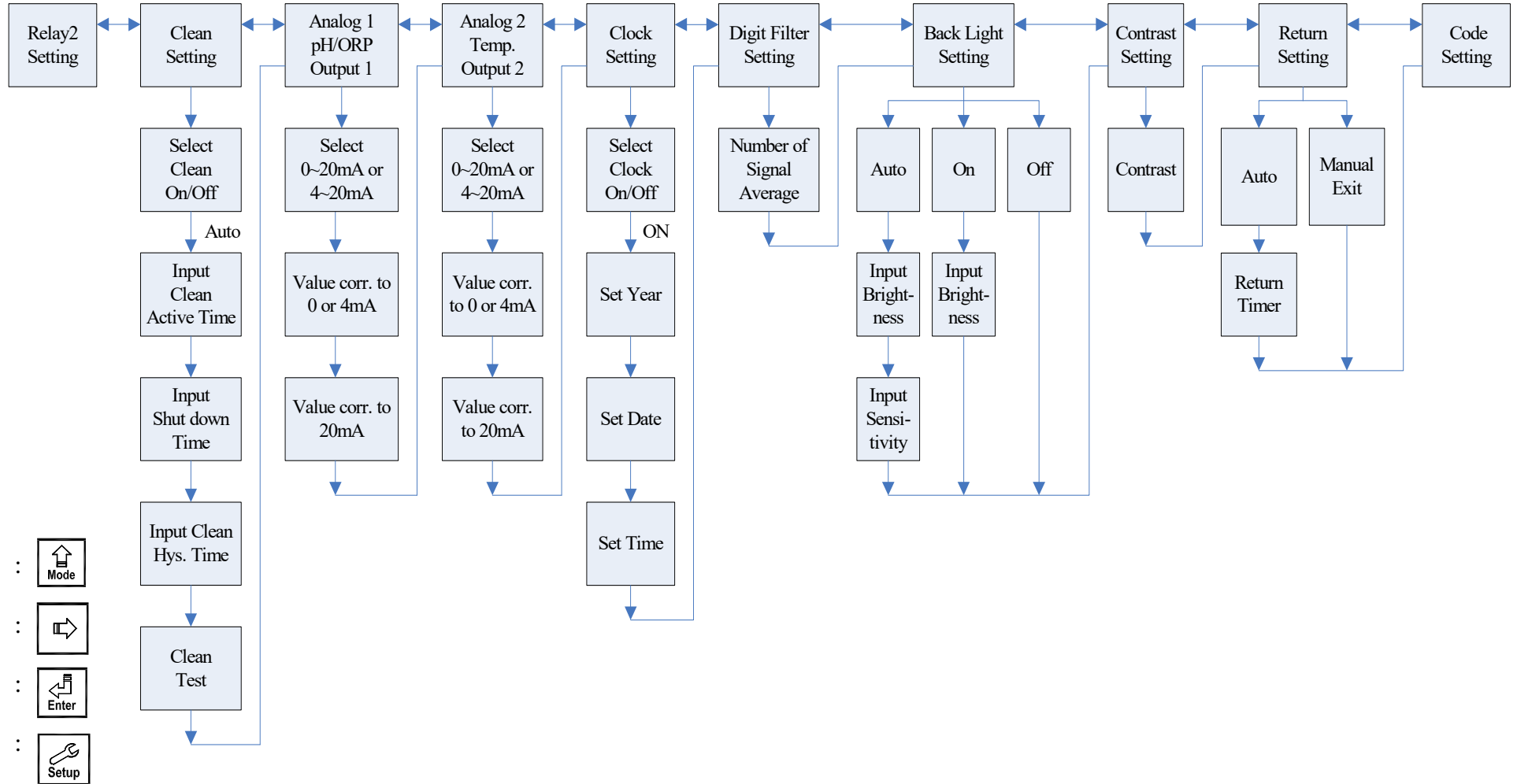

Settings Block Diagram – Part 2



6.1 Settings Menu

Under measurement mode, press  and  simultaneously to display current settings overview. Press  to return to measurement mode or press  to enter settings menu.

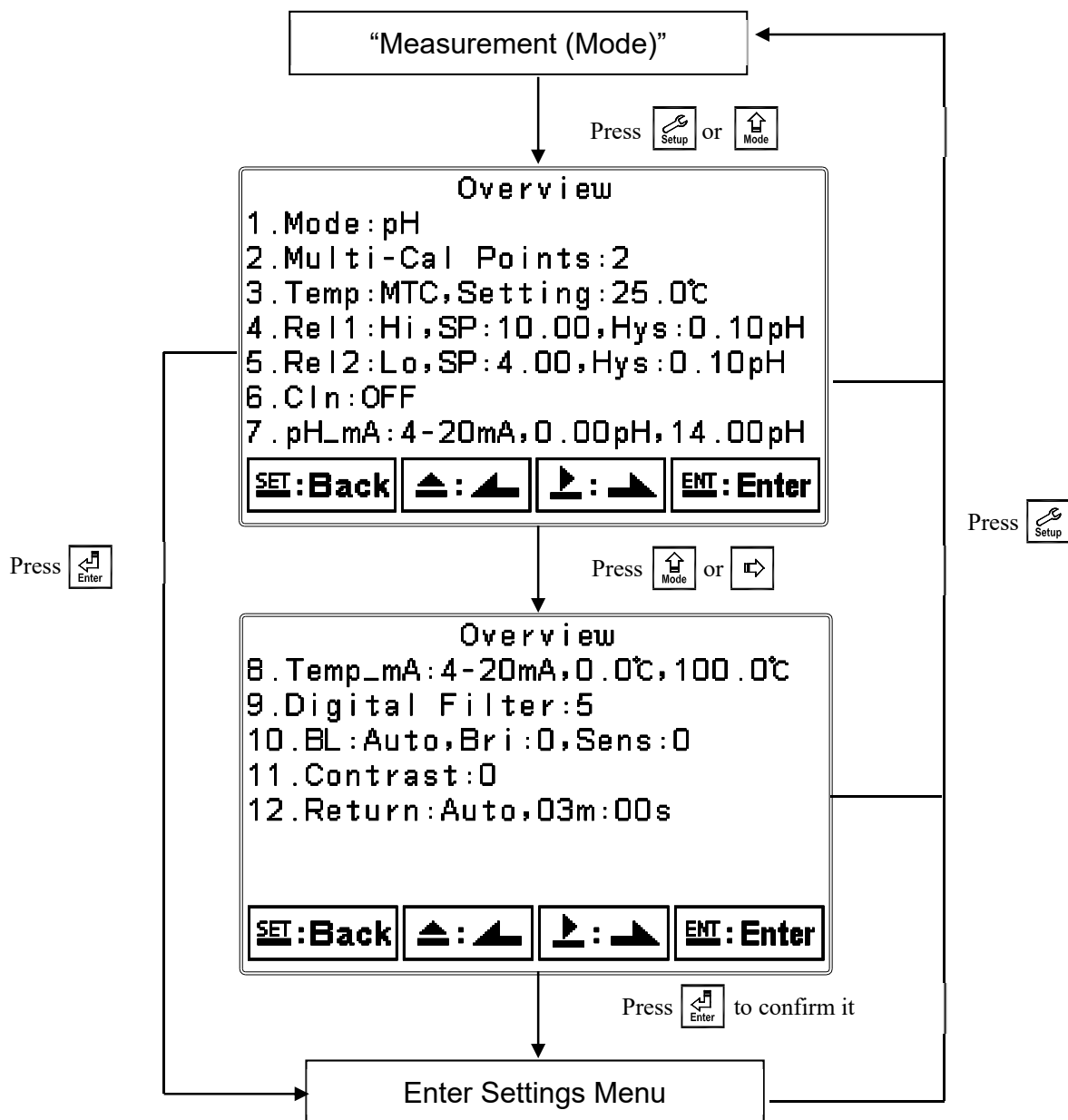

6.2 Settings Security Code (Code)

Enter settings menu, select “Code” to setup passcode protection.

The default calibration passcode is “1111”.

Note: The passcode for settings mode is at a higher security level than the passcode for calibration mode. The passcode for settings mode can be used to unlock calibration mode.

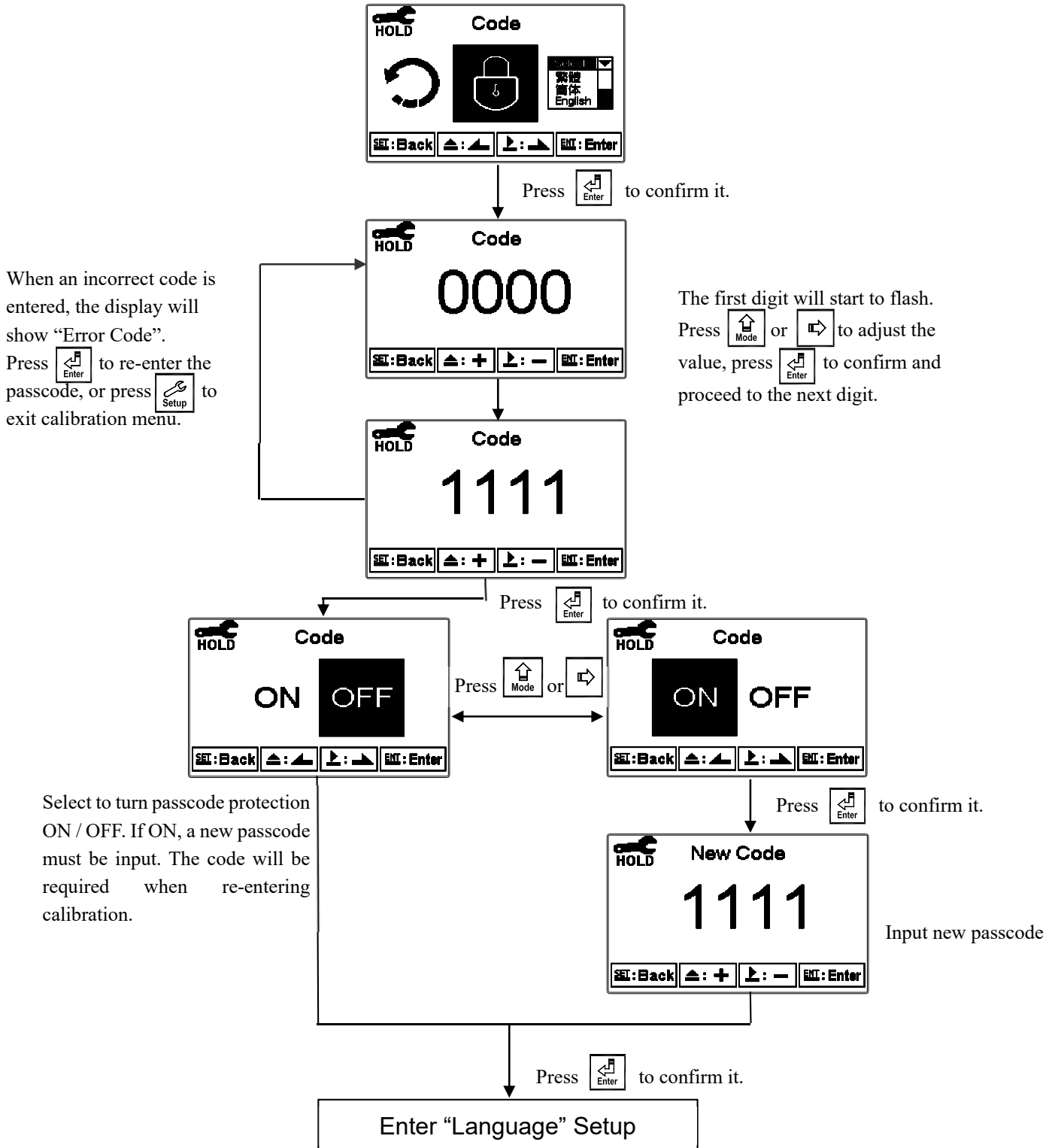

6.3 Language

Enter settings menu, select “Language” to change system language. Select from English, Traditional Chinese or Simplified Chinese.

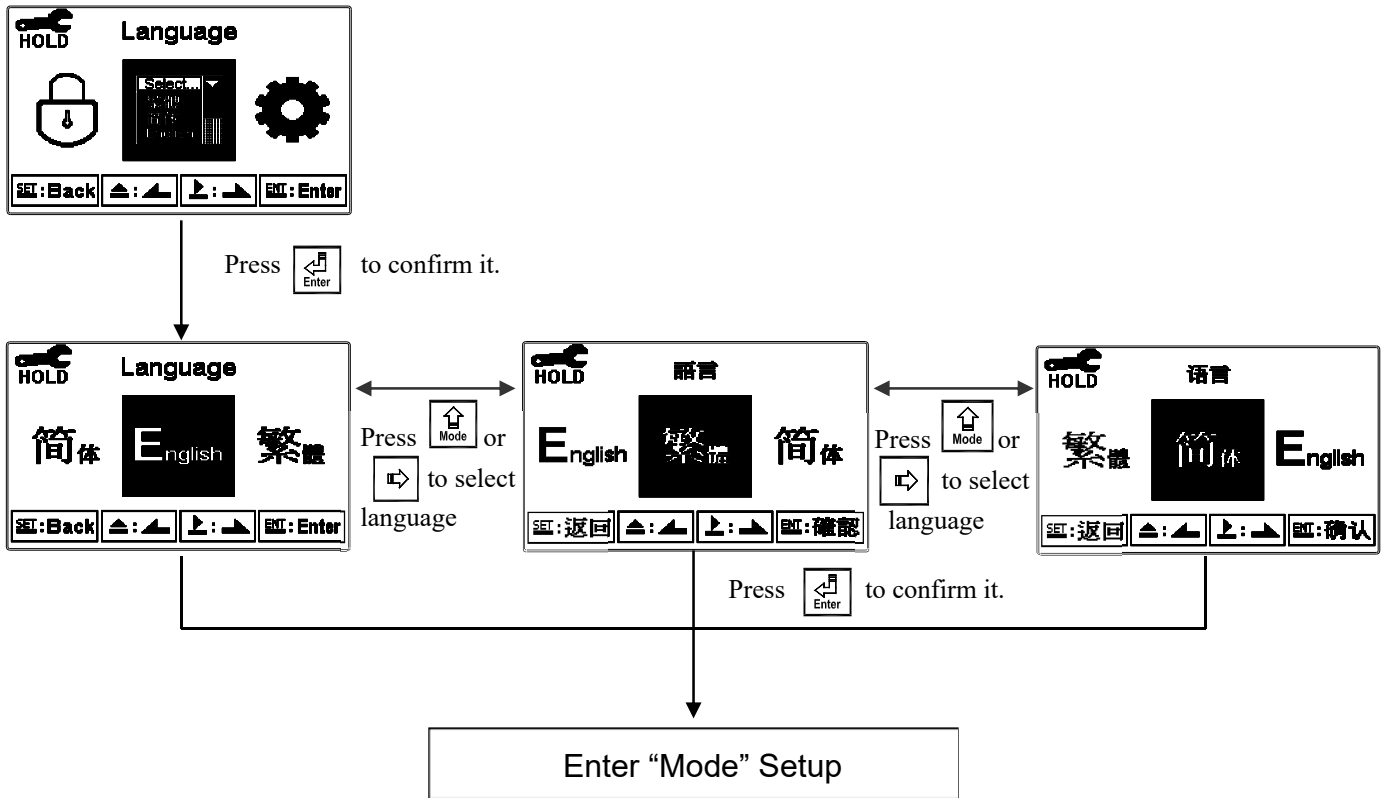

6.4 Measurement Parameter (Mode)

Enter setup menu, select “Mode” to change measurement parameter. Select between pH or ORP mode.

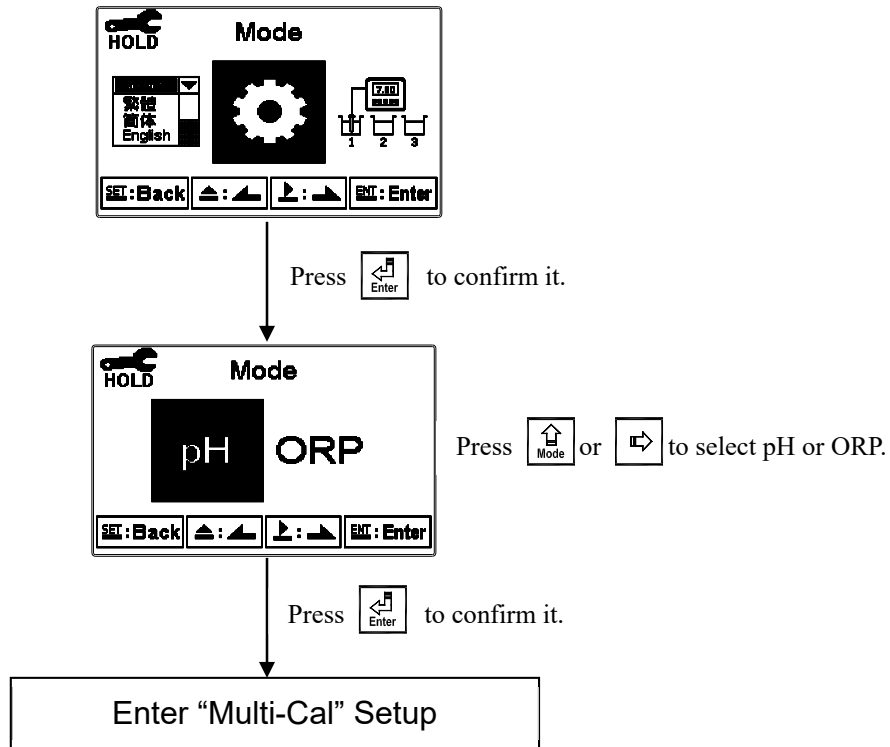

6.5 Multi-Point Calibration (Multi-Cal)

Enter settings menu, select “Multi-Cal” to adjust the number of calibration points. This function only applies to pH measurement.

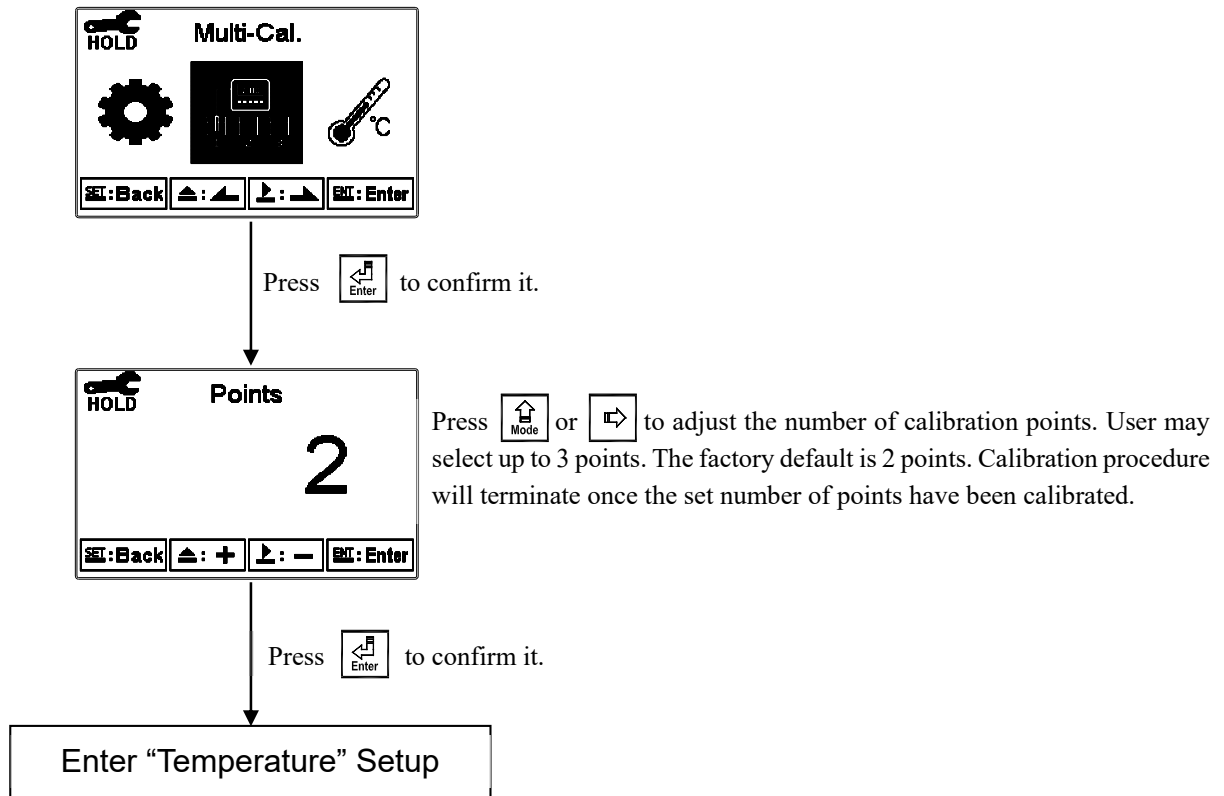

6.6 Temperature

Enter settings menu, select “Temperature” to change temperature compensation mode. Select from NTC (NT 30K), PTC (PT 1K) or MTC (Manual adjustment).

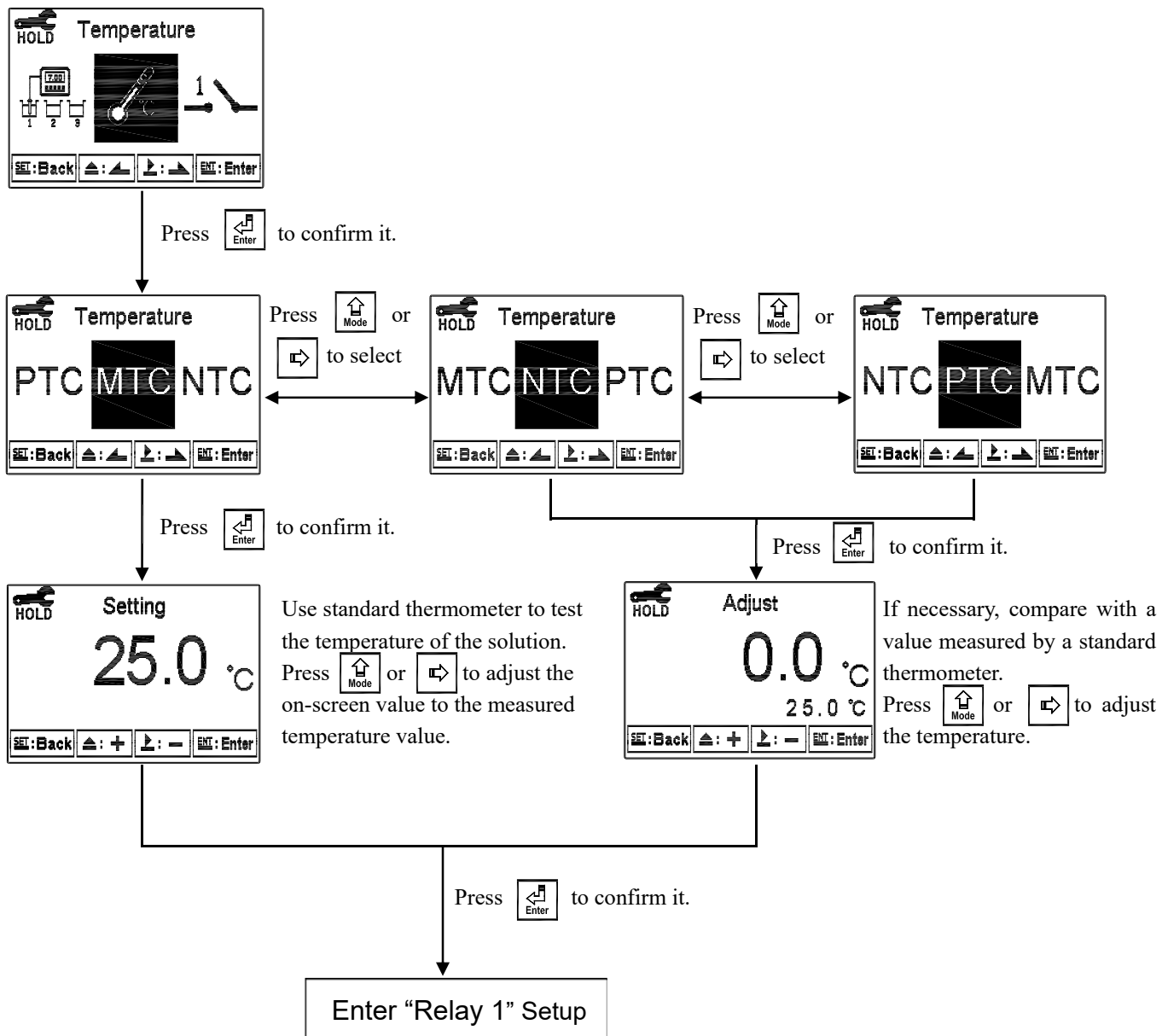

6.7 Relay 1

Enter settings menu, select “Relay 1” to configure Relay 1. To turn on, set to “Auto”, select “High Point” alarm or “Lo Point” alarm, then set the Set-Point (SP) and Hysteresis (Hys.) values. Refer to the graph below for the relationship of the terms used in the case of high point alarm control.

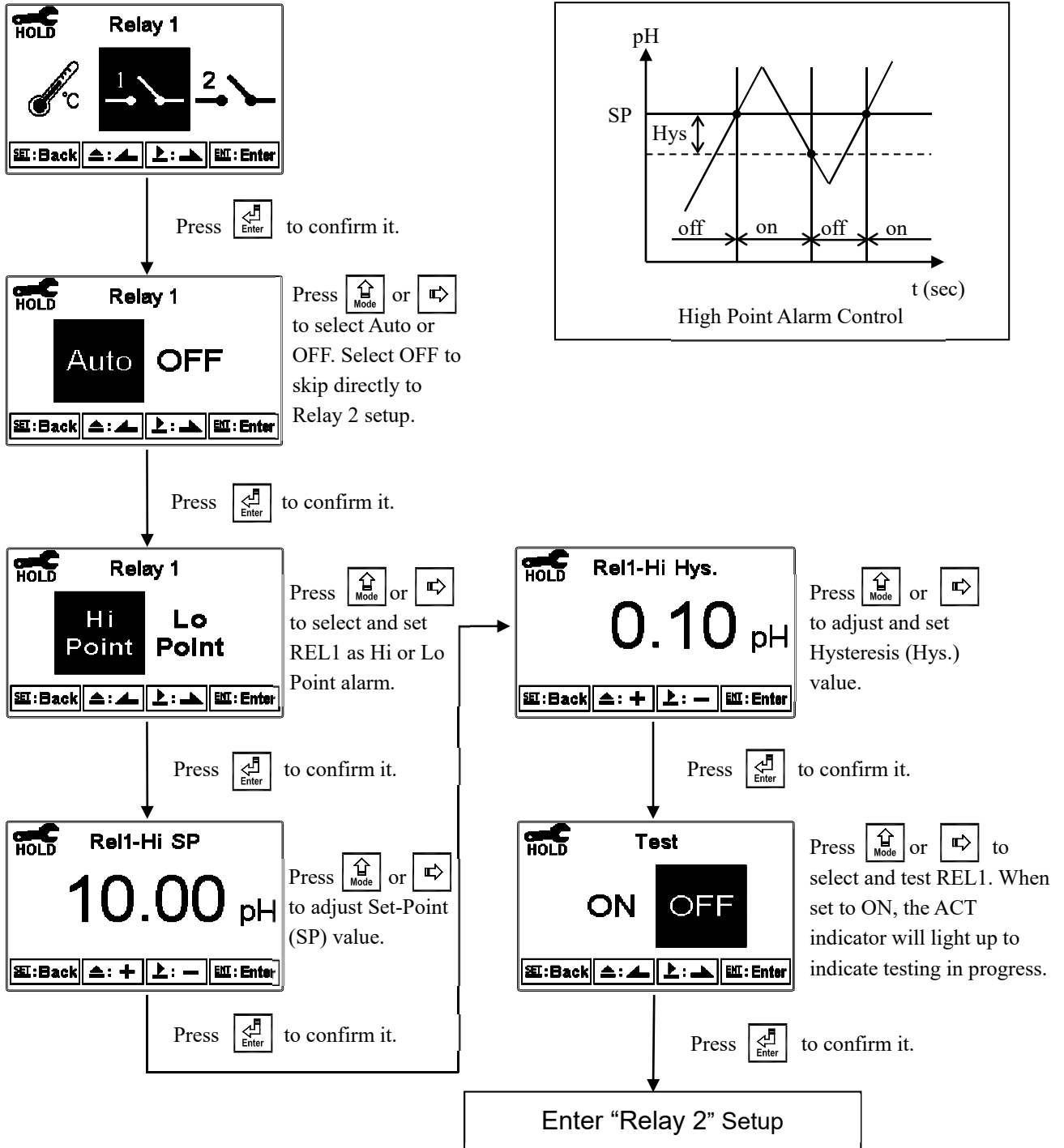

6.8 Relay 2

Enter settings menu, select “Relay 2” to configure Relay 2. To turn on, set to “Auto”, select “High Point” alarm or “Lo Point” alarm, then set the Set-Point (SP) and Hysteresis (Hys.) values. Refer to the graph below for the relationship of the terms used in the case of low point alarm control.

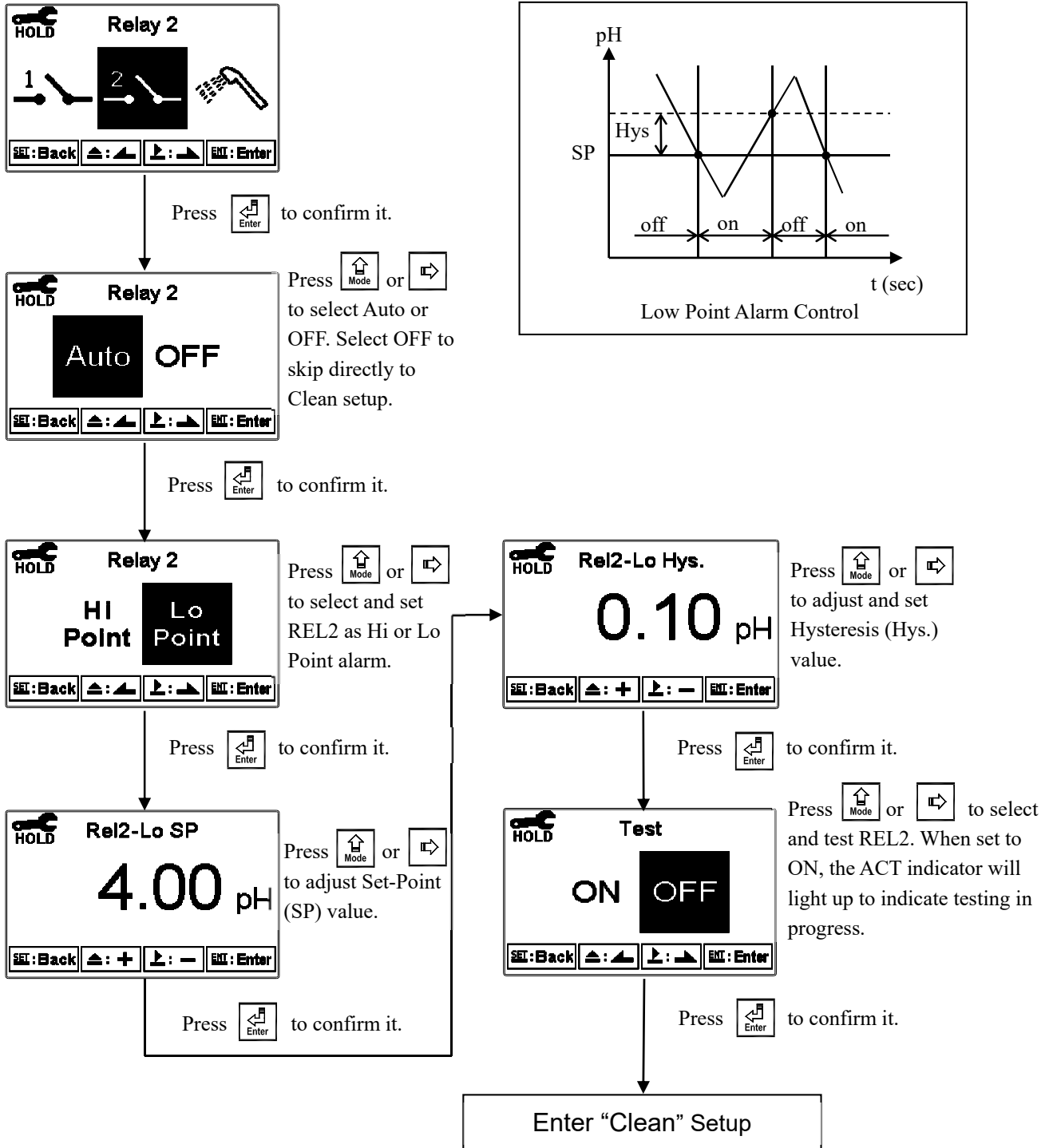

6.9 Clean

Enter settings menu, select “Clean” to setup relay activated cleaning. To turn on, set to “Auto”, set cleaning “ON” duration, set cleaning “OFF” duration, then set the Hysteresis (Hys.) value. Refer to the graph below for the relationship of the terms used.

Note: A “Clean Running” message will show on the main measurement screen when “Clean” is activated. The measurement value will remain at the last measured value before cleaning. When entering settings menu or calibration menu under cleaning status, the transmitter will automatically pause cleaning. When “Clean” is set to AUTO, if any time value is set to 0, the instrument will terminate the cleaning process.

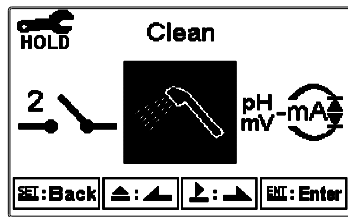

Press to confirm it.

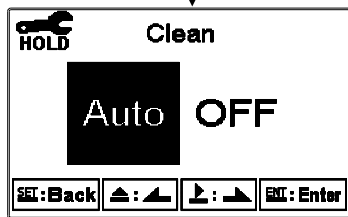

Press or to select Auto or OFF. Select OFF to skip directly to Analog 1 setup.

Press to confirm it.

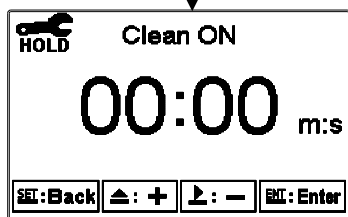

Press or to adjust minutes, then press to confirm and adjust seconds.

Press to confirm it.

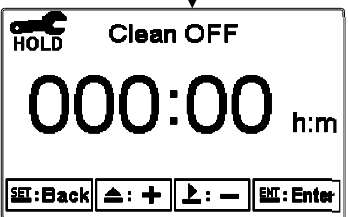

Press or to adjust minutes, then press to confirm and adjust seconds.

Press to confirm it.

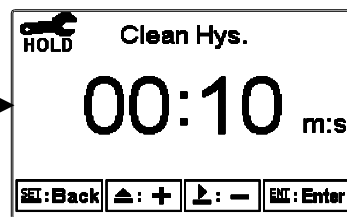
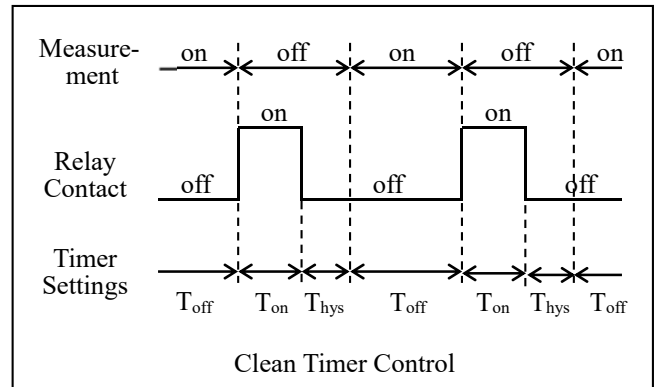

Press or to adjust and set Hysteresis (Hys.) time.

Press to confirm it.

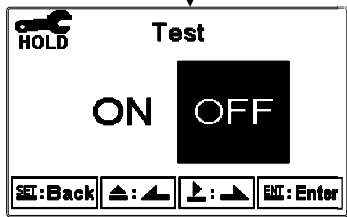

Press or to select and test Clean. When set to ON, the ACT indicator will light up to indicate testing in progress.

Press to confirm it.

Enter “Analog 1” Setup

6.10 Analog Output 1 (pH/ORP)

Enter settings menu, select “Analog 1” to configure Analog 1 output. Select the appropriate output current, then set the corresponding pH/ORP measurement range limits. The smaller the set range, the greater the current output resolution. When the measured value is greater than the upper limit, the output current will remain approximately 22 mA. When the measured value is less than the lower limit, the output current will remain 0 mA (0~20 mA mode) or 2 mA (4~20 mA mode). Either can be used as an indicator for analytical failure. Under HOLD status, the current output will remain at the last output value. For the convenience of setting up an external recorder or PLC controller, the current output will remain at 0/4 mA and 20 mA during their respective 0/4 and 20 mA setup.

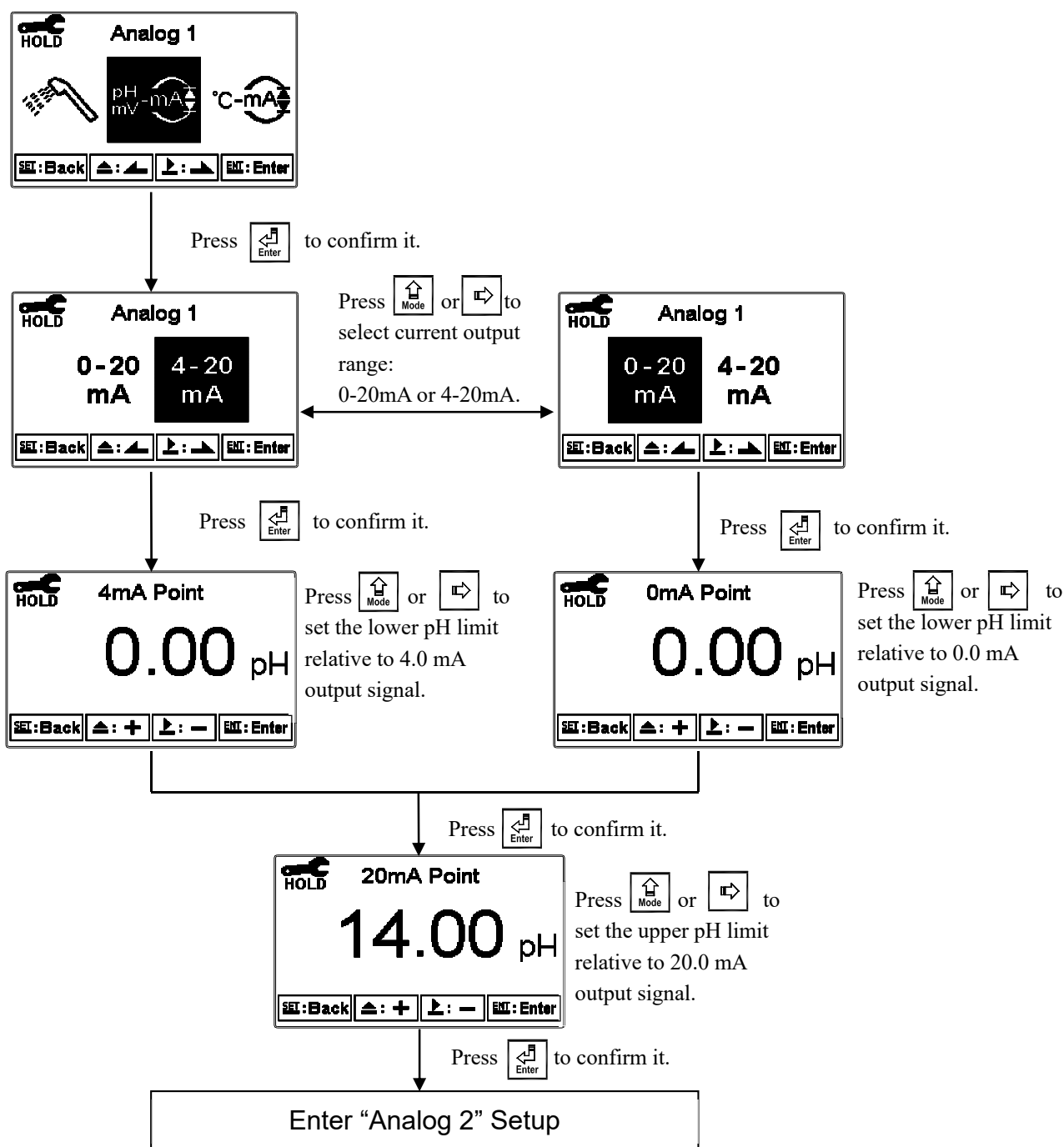

6.11 Analog Output 2 (Temperature)

Enter settings menu, select “Analog 2” to configure Analog 2 output. Select the appropriate output current, then set the corresponding temperature measurement range limits. The smaller the set range, the greater the current output resolution. When the measured value is greater than the upper limit, the output current will remain approximately 22 mA. When the measured value is less than the lower limit, the output current will remain 0 mA (0~20 mA mode) or 2 mA (4~20 mA mode). Either can be used as an indicator for analytical failure. Under HOLD status, the current output will remain at the last output value. For the convenience of setting up an external recorder or PLC controller, the current output will remain at 0/4 mA and 20 mA during their respective 0/4 and 20 mA setup.

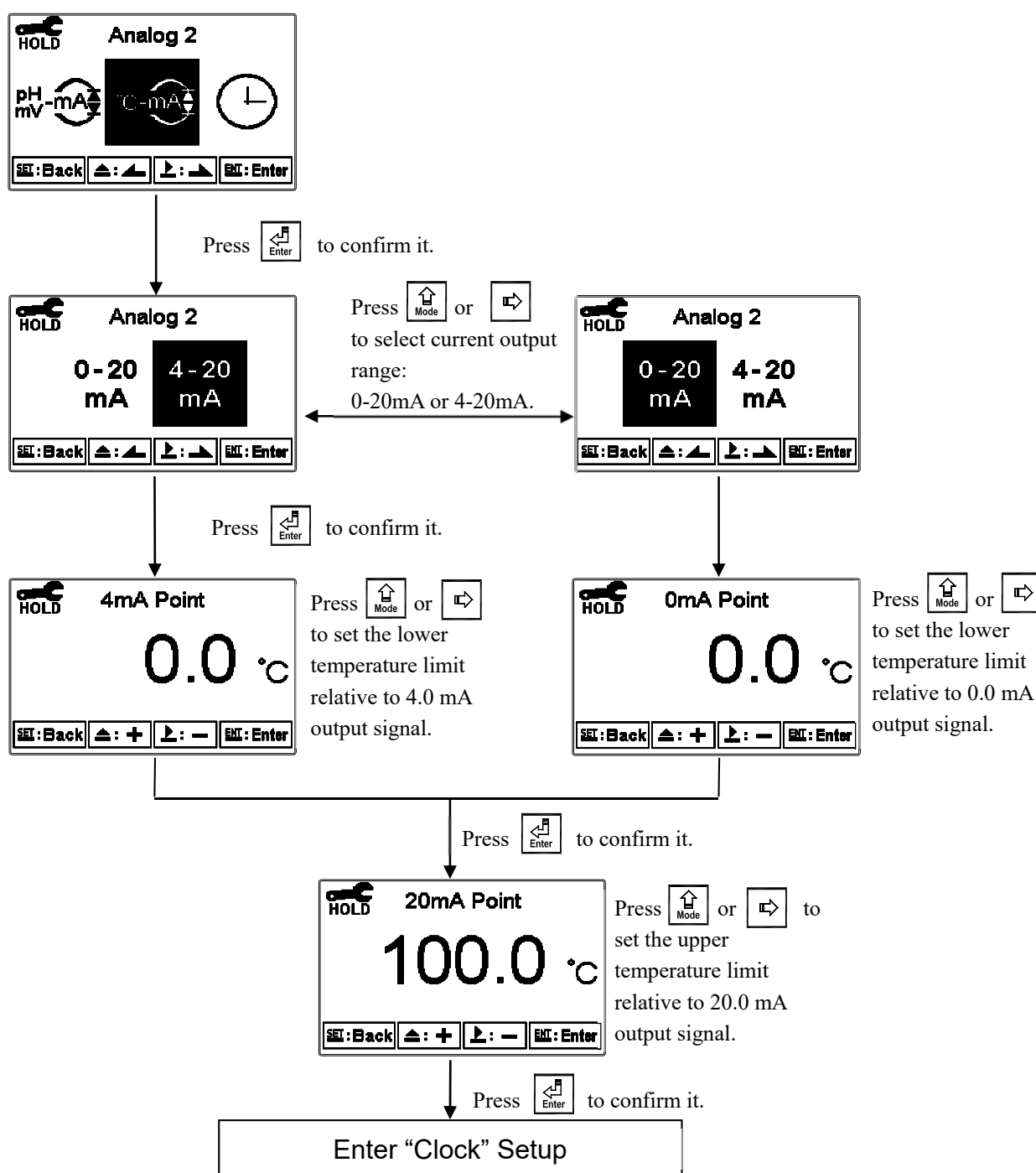

6.12 Date/Time (Clock)

Enter settings menu, select “Clock” to adjust the system date and time. If the clock is turned off, the time and date will not be displayed under measurement mode. The calibration time under the calibration info. page will also display as “OFF”.

Note: The clock needs to be reset following a power failure.

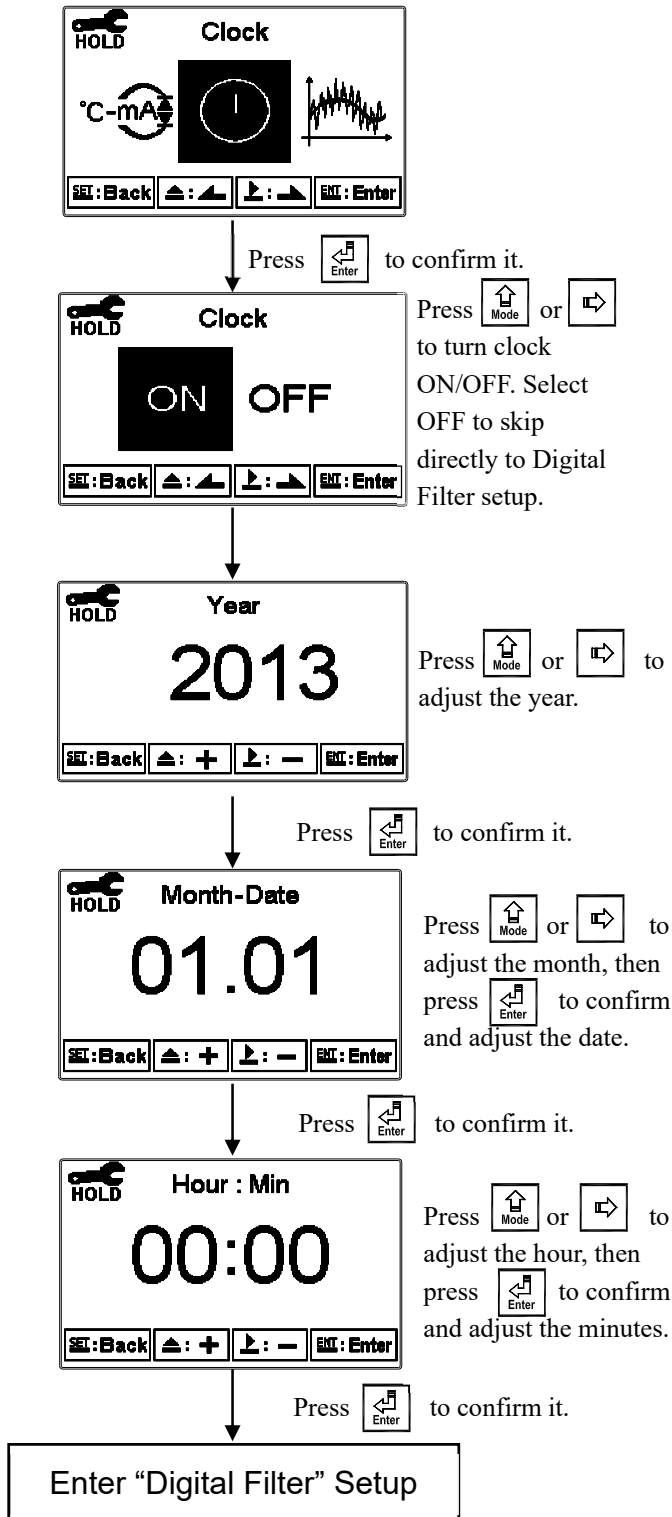

6.13 Sample Measurement Average (Digital Filter)

Enter settings menu, select “Digital Filter” to configure digital filter settings. Adjust the number of samples to be averaged for each reading. Increasing the number of samples needed increases the stability of the resulting measurement value.

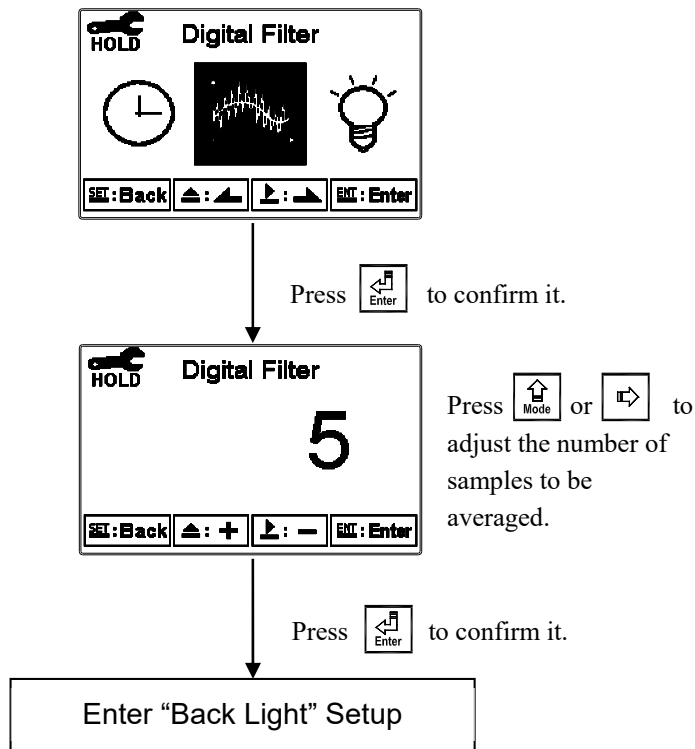

6.14 Back Light

Enter settings menu, select “Back Light” to configure backlight settings. The user can adjust the brightness of display from -2 ~ 2 (dark ~ bright), and sensitivity of the surrounding brightness sensor from -2 ~ 2 (insensitive ~ sensitive). Whether under OFF or AUTO mode, the touch-on function will activate the backlight when any button is pressed. If no buttons are pressed for 5 seconds, the display will return to the original backlight mode.

ON setting: The backlight is always on.

OFF setting: The backlight is off. Touch-on status activated by pressing any button.

Auto setting: The transmitter will activate or deactivate the backlight according to the ambient lighting. Touch-on status activated by pressing any button.

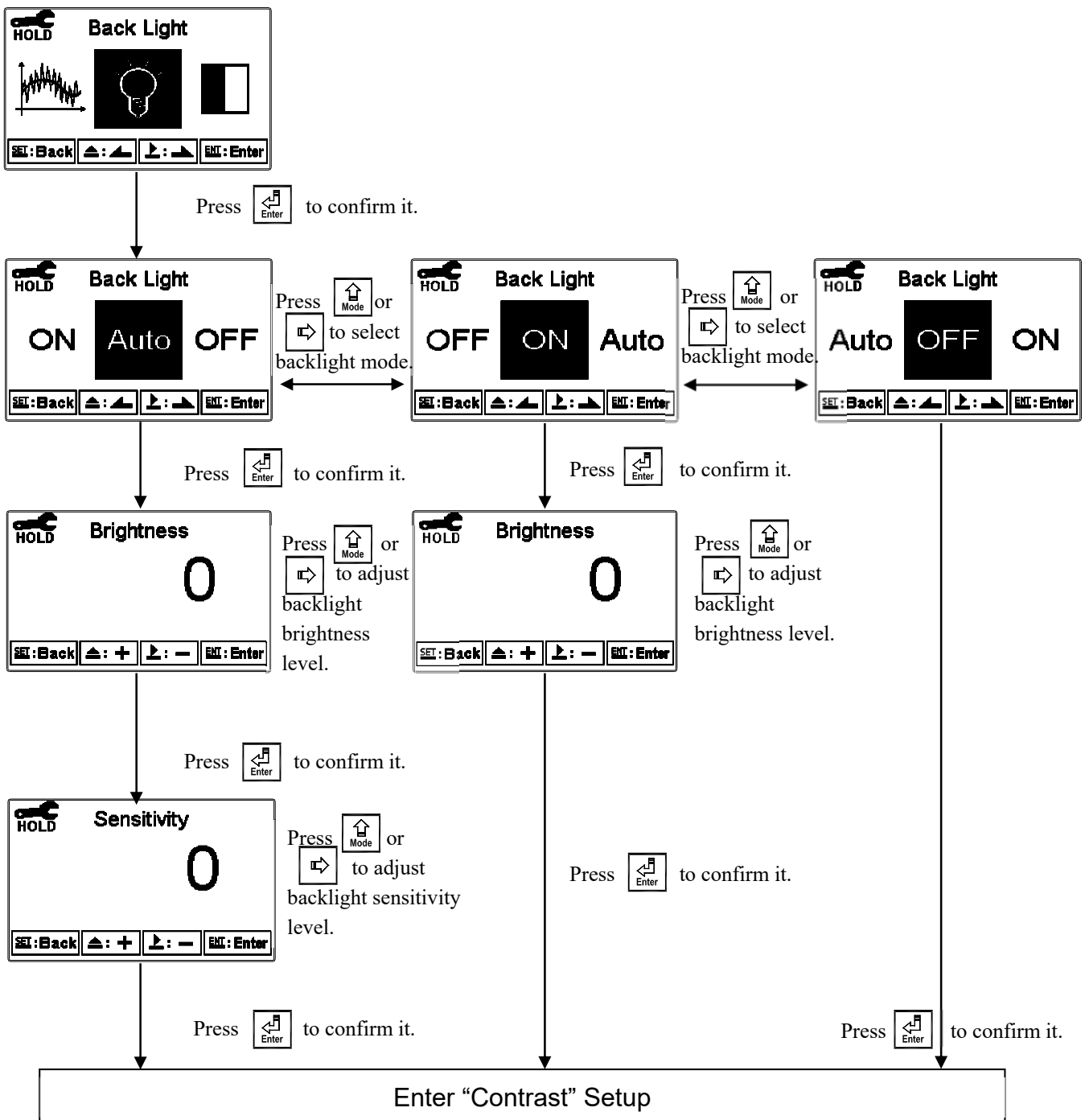

6.15 Contrast

Enter settings menu, select “Contrast” to adjust transmitter display contrast. The user can adjust the contrast of the display from -2 ~ 2 (dark ~ bright).

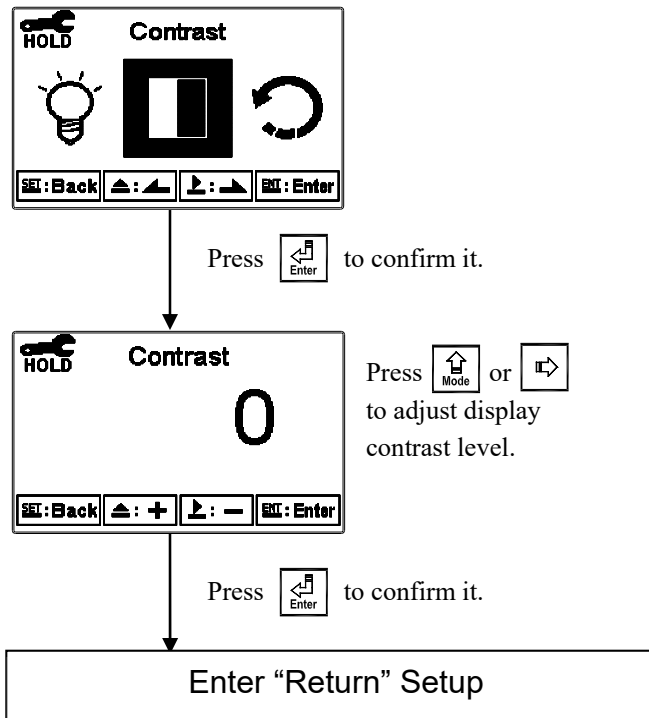

6.16 Automatic Return (Return)

Enter settings menu, select “Return” to adjust the time interval for automatic exit from settings mode to measurement mode. Select “Auto” to allow the transmitter to automatically exit settings mode after a duration of time. Select “Manual Exit” to prevent the transmitter from exiting settings mode automatically.

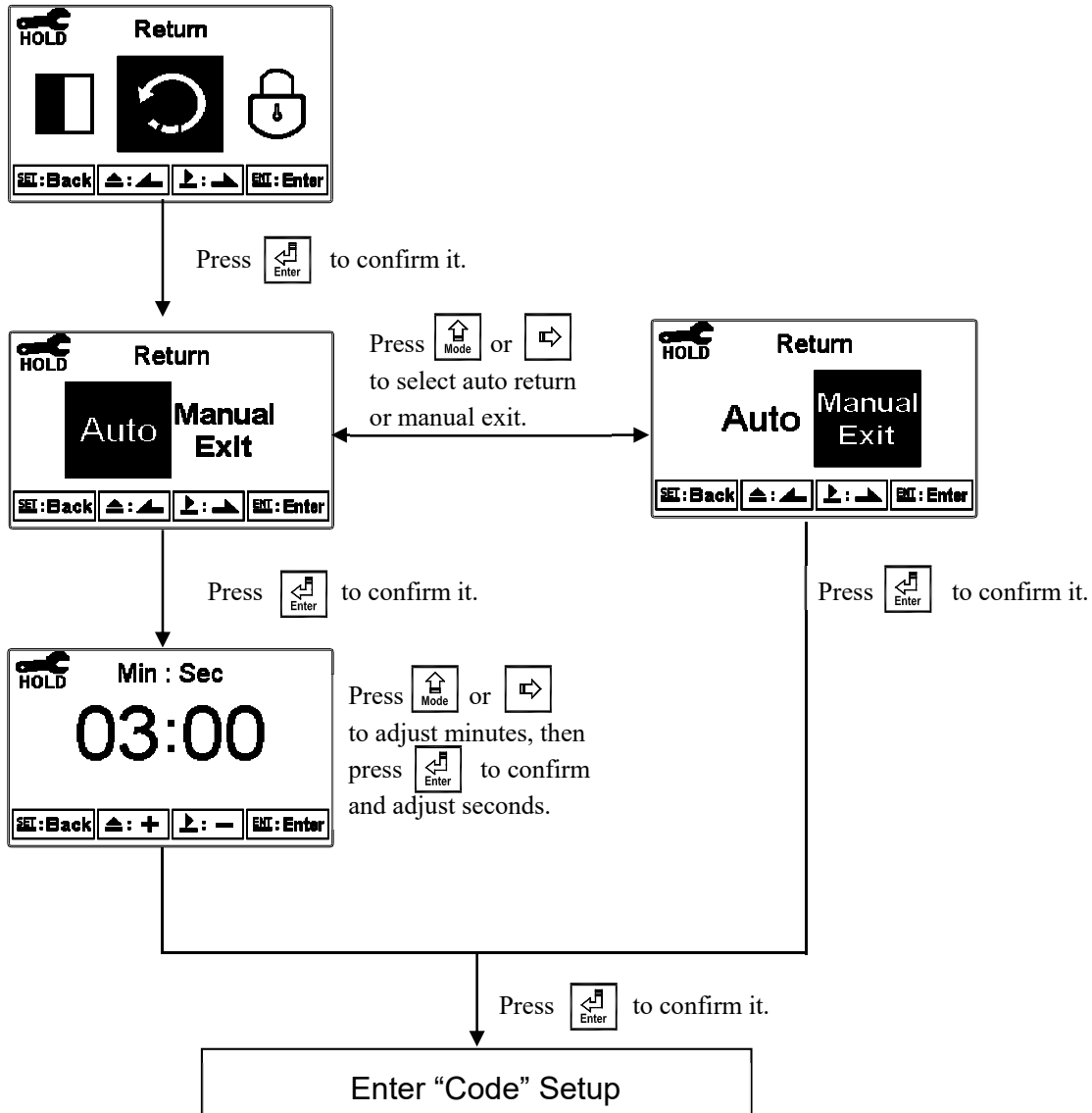



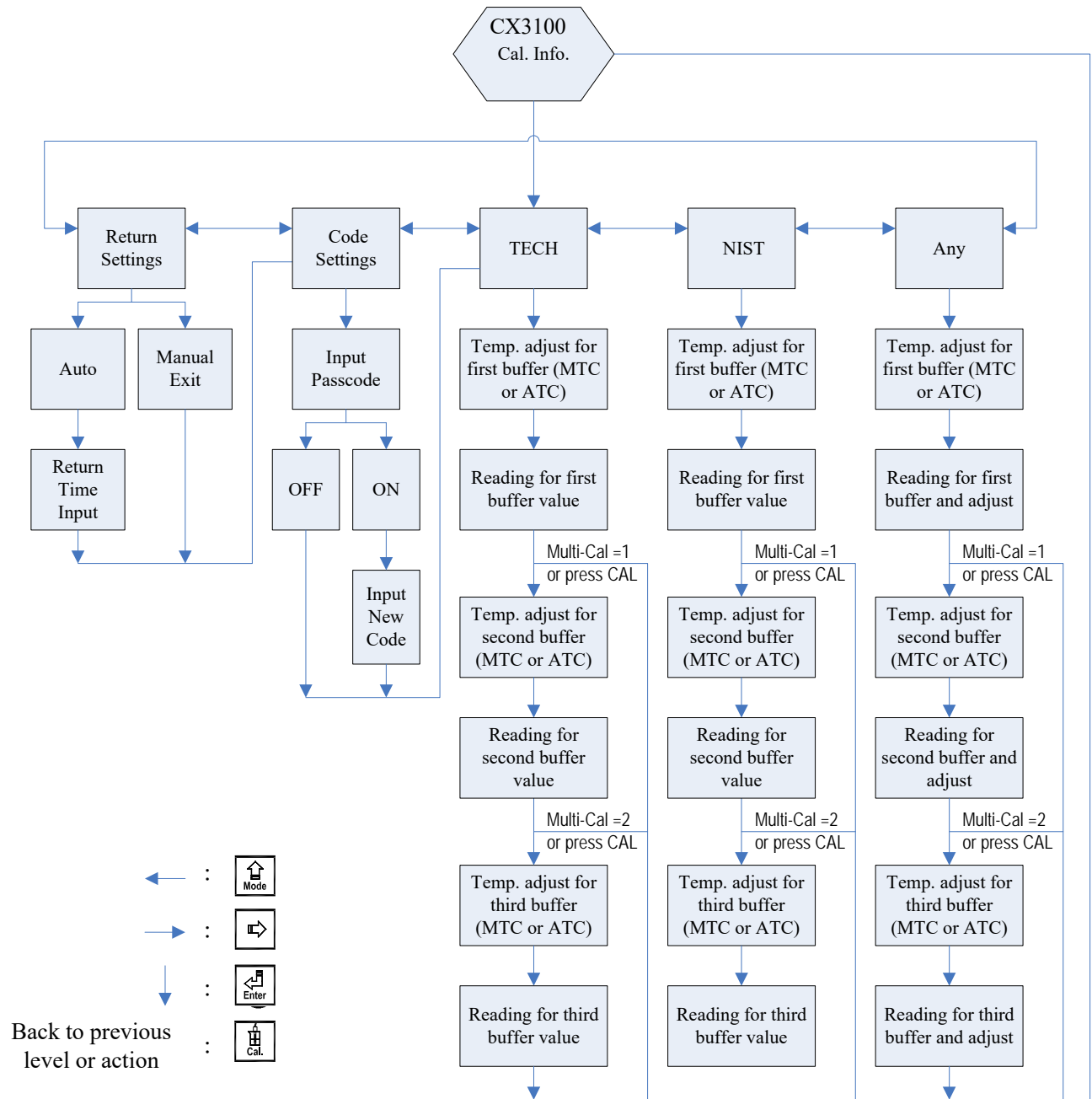

7. Calibration

Calibration Block Diagram



7.1 Calibration Menu

Under measurement mode, press  and  simultaneously to display current calibration information overview. If calibration is not needed, press  to return to measurement mode. To recalibrate, press  to enter calibration menu.

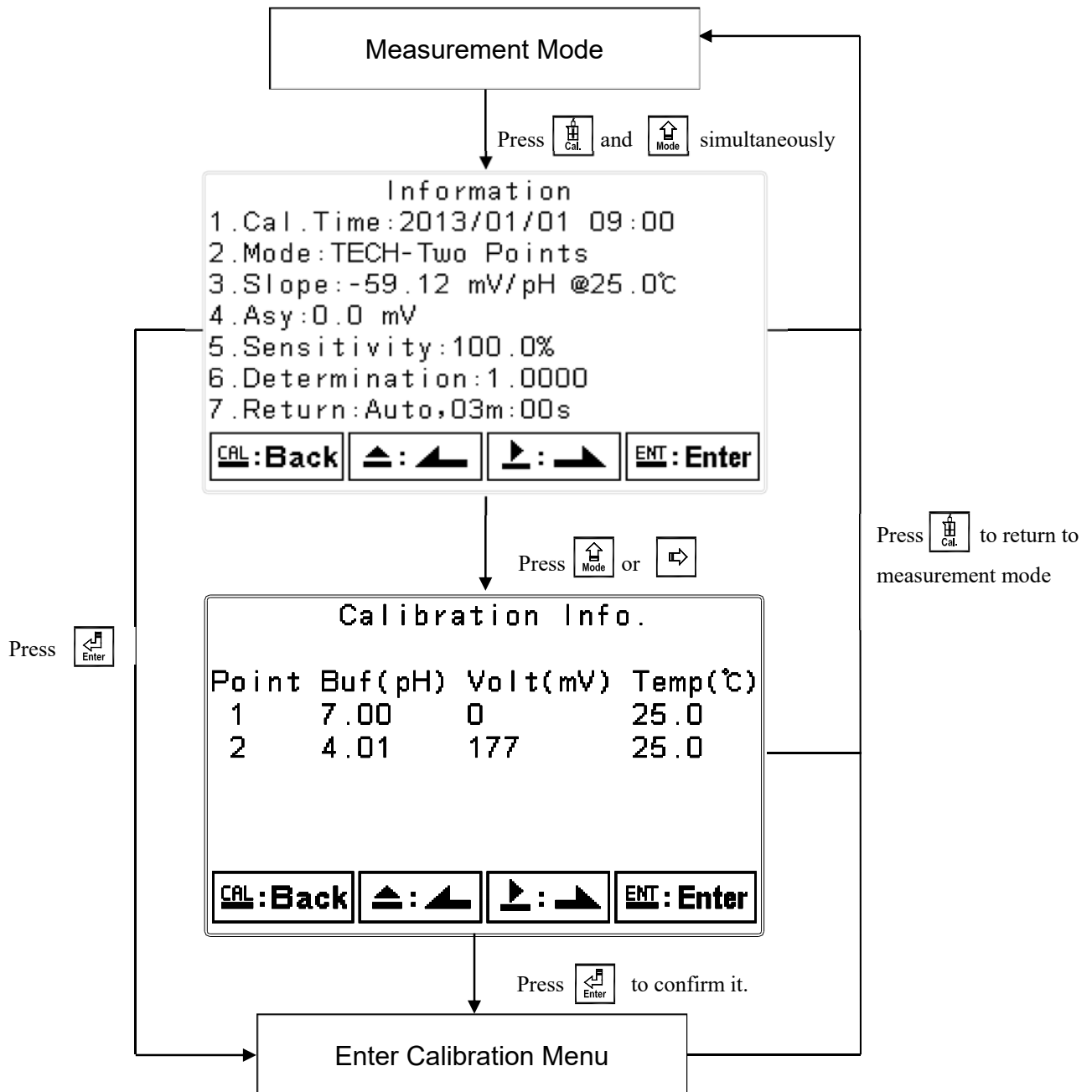

7.2 Calibration Security Code (Code)

Enter calibration menu, select “Code” to setup passcode protection.

The default calibration passcode is “1100”.

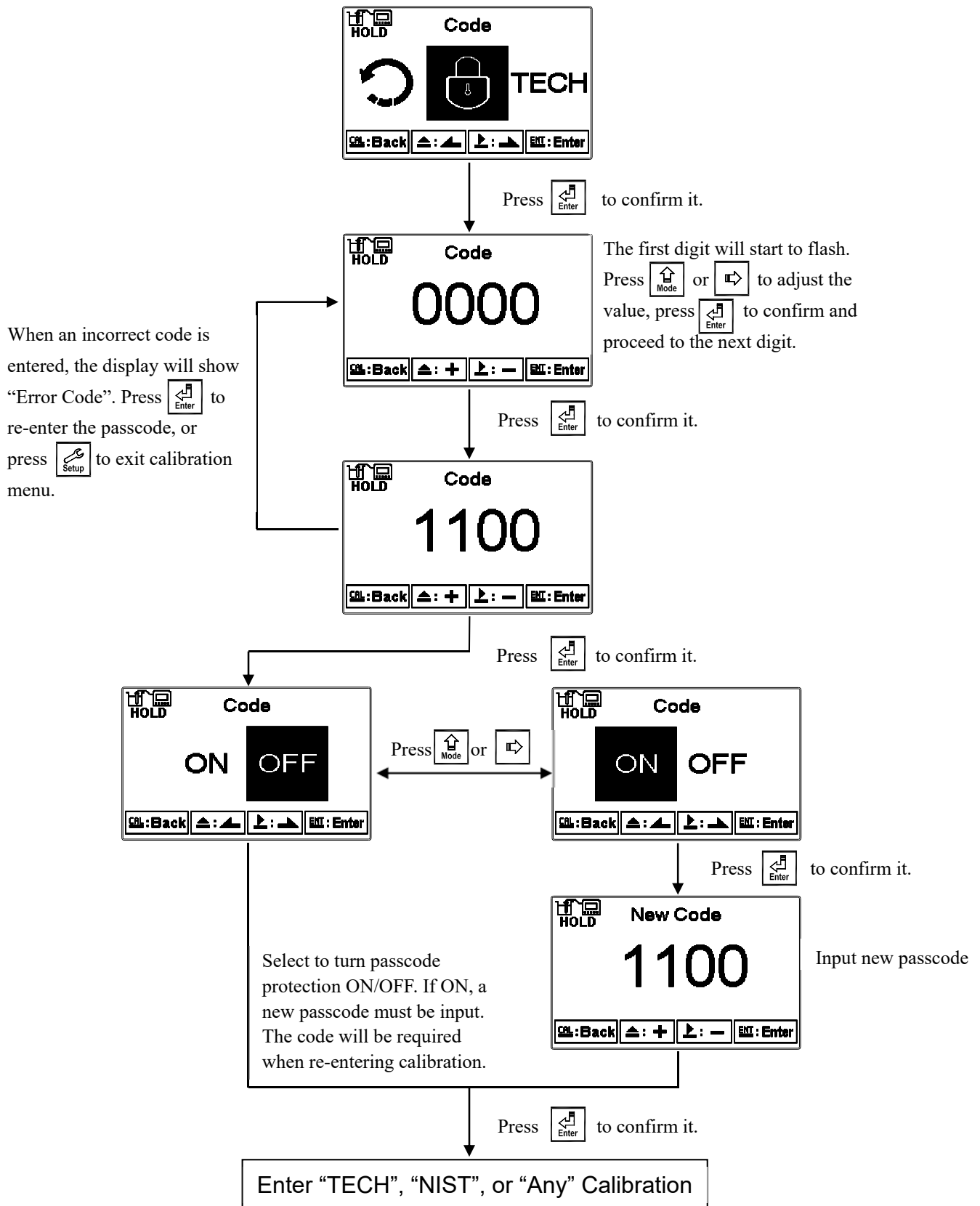

7.3 pH Calibration

This instrument provides multi-point standard buffer solution calibration. The user can decide the number of standard pH buffer points to calibrate to. The principle for calibration is according to “Method of Least Squares” that applies linear regression to calibrate the electrode’s slope and zero point (asy, offset, or zero point).

When calibrating an electrode, multi-point calibration can be done in any sequence. The mV and pH value of each point is recorded and applied to calculate the electrode’s slope and zero point (asy, offset, or zero point) at 25°C. The electrode’s slope and theoretical slope ratio is displayed as the electrode’s sensitivity in percentage (%). The coefficient of determination (r^2) for the measured points (electrode) and the standard buffer solution is also calculated to determine how close the data are to the fitted regression line. TECH, NIST, and Any buffer solution calibration modes are provided to accommodate different combinations of buffer solutions.

7.3.1 TECH Buffer Mode

The transmitter will automatically calibrate the electrode with the three built-in TECH buffer solution points (4.01, 7.00, 10.00) and the corresponding temperature. The range for the electrode’s zero point and slope is also determined. If either is over the accepted range, an error message will occur indicating slope and zero point failure. (See Appendix Table 1, pH/Temperature Table of TECH Standard Buffers)

7.3.2 NIST Buffer Mode

The transmitter will automatically calibrate the electrode with the five built-in NIST buffer solution points (1.68, 4.01, 6.86, 9.18, and 12.45) and the corresponding temperature. The range for the electrode’s zero point and slope is also determined. If either is out of the accepted range, an error message will occur indicating slope and zero point failure. (See Appendix Table 2, pH/Temperature Table of NIST Standard Buffers)

7.3.3 Any Buffer Mode

The transmitter will measure the mV value of the given standard buffer solution and determine the closest pH value based on the theoretical slope and temperature of the standard buffer solution. The user will then need to manually adjust the measured pH value to that of the standard buffer solution. Under any buffer mode, only slope range is determined. If the slope is out of the accepted range, an error message will occur indicating slope range failure.

7.3.4 Calibration Parameters

The user may calibrate the electrode by one point or up to three points of standard buffer solutions in any sequence. As different calibration point methods are applied, the determinants of the zero point and slope are also different.

Calibration Point	Determinant	Displayed Calibration Value
One point calibration	Asy	Zero point (asy, offset or zero point) = Asy 1.If not calibrated, Slope = Theoretical slope 2.If calibrated, Slope = Slope of last calibration
Two or more points calibration	Asy Slope	Zero point (asy, offset or zero point) = Asy Slope = Slope* Note: Obtain new zero point (Asy) and Slope by applying linear regression.

7.3.5 TECH, NIST Buffer Calibration

The procedure below is for two point calibration of TECH buffers (this procedure is also applicable to NIST buffer mode). Enter settings menu, select “Multi-Cal.” then set the number of calibration points to 2 (see chapter 6.5, Multi-Point Calibration). Enter calibration menu, select “TECH” and to calibrate. Operate according to the diagrams below. For three point calibration, “Multi-Cal.” must be set to three in advance; the calibration procedure is the same.

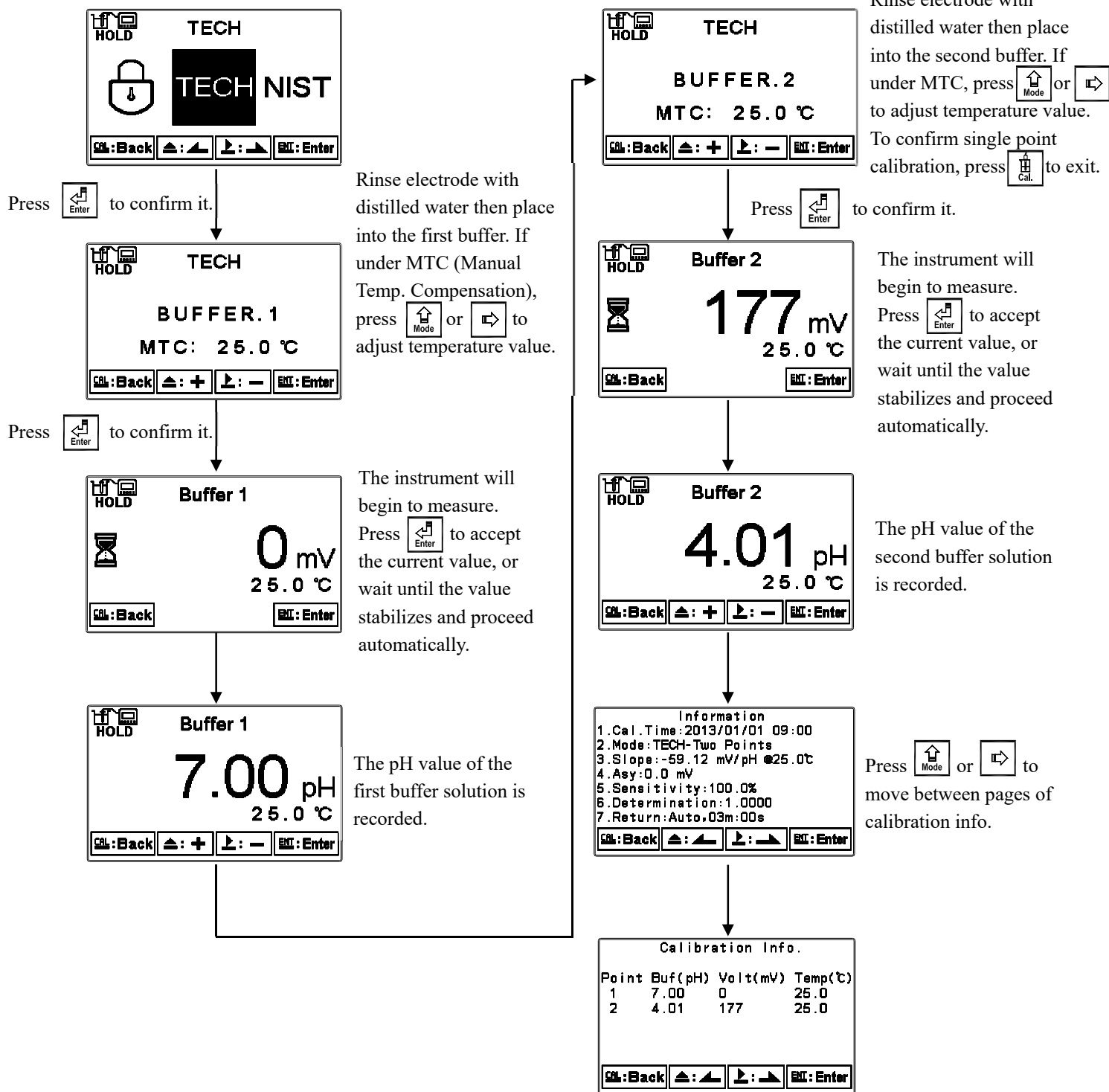

7.3.6 Any Buffer Calibration

The procedure below is two point calibration for Any buffers. Enter settings menu, select “Multi-Cal.” then set the number of calibration points to 2 (see chapter 6.5, Multi-Point Calibration). Enter calibration menu, select “Any” to calibrate. Operate according to the diagrams below. For three point calibration, “Multi-Cal.” must be set to three in advance; the calibration procedure is the same.

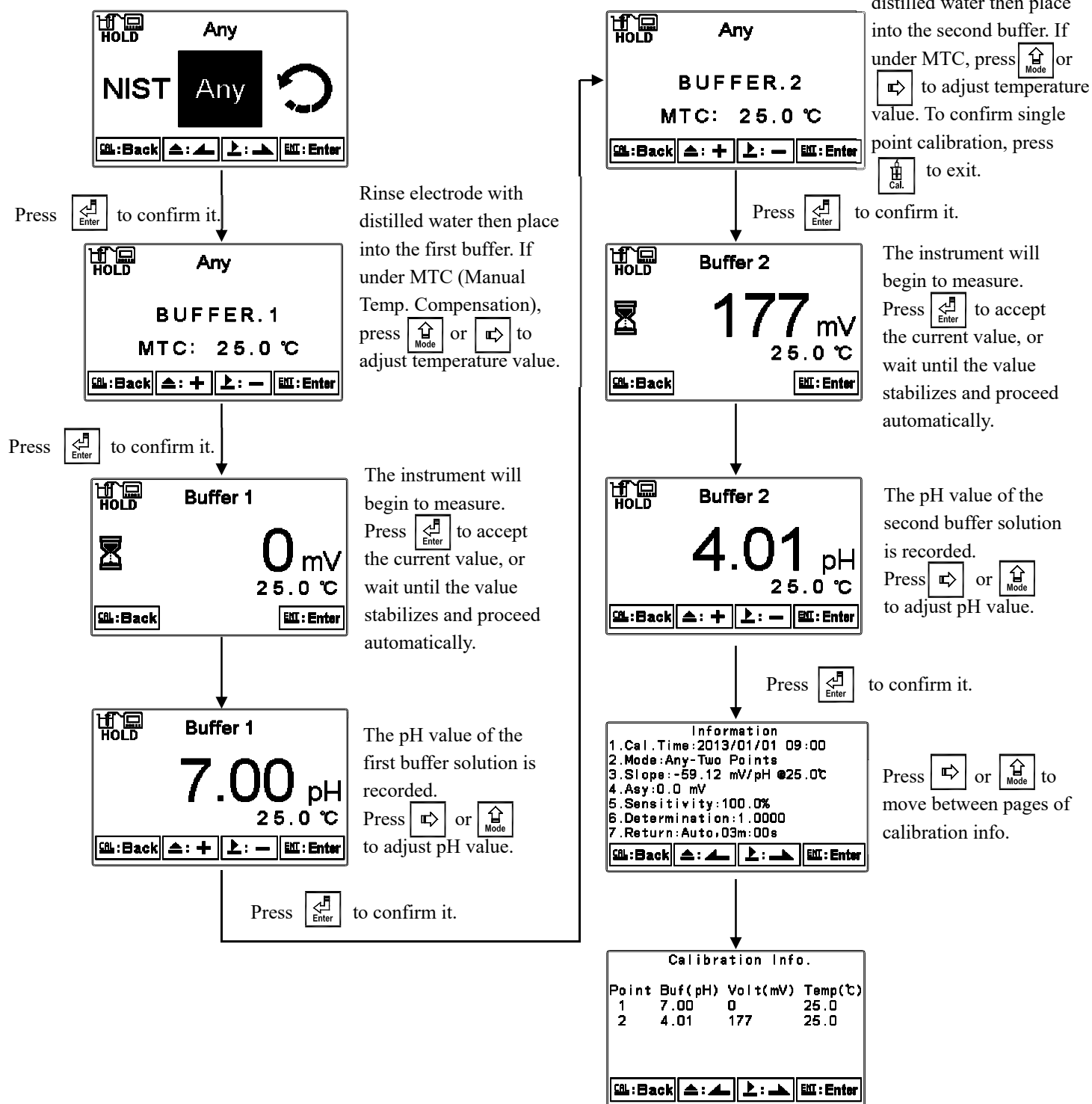

7.4 ORP Calibration

Enter settings menu, select “Mode” then select “ORP” to change transmitter settings to ORP mode. Enter calibration menu, select “Calibration” to input ORP calibration value. The acceptance range is from -300mV to 300mV.

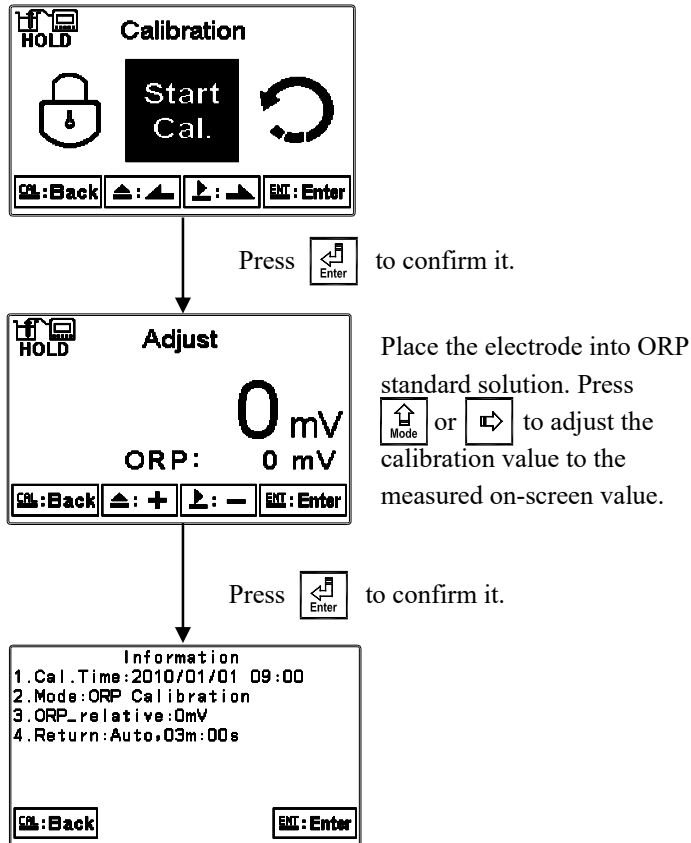

7.5 Automatic Return (Return)

Enter calibration menu, select “Return” to adjust the time interval for automatic exit from calibration mode. Select “Auto” to allow the transmitter to automatically exit calibration mode after a duration of time. Select “Manual Exit” to prevent the transmitter from exiting calibration mode automatically.

Note: The return function of setup menu and calibration setup menu are independent settings.

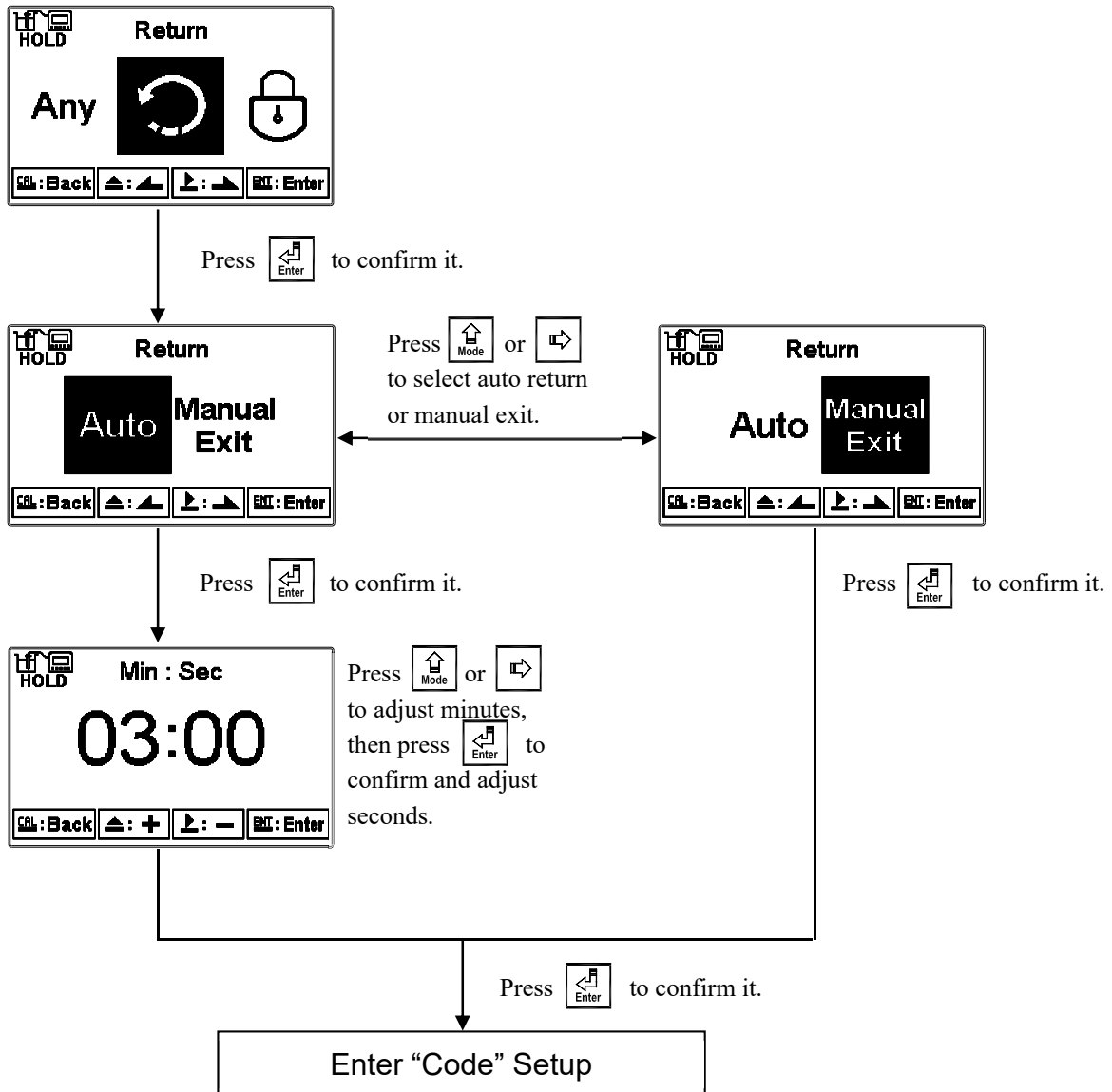

8. Error Messages (Error Codes)

Message	Reason	Dispositions
Error1	Asy (Zero-point) exceeds upper/lower limit.	<ol style="list-style-type: none"> 1. Please use fresh buffer solution. 2. Maintain or replace electrode and make another calibration.
Error2	Slope exceeds upper/lower limit.	<ol style="list-style-type: none"> 1. Please use fresh buffer solution. 2. Maintain or replace electrode and make another calibration.
Error3	The readout is unstable.	<ol style="list-style-type: none"> 1. Please check and clear electrode glass end of air bubbles. 2. Maintain or replace electrode and make another calibration.
Error4	<ol style="list-style-type: none"> 1. The temperature is over range (0~50°C) during calibration. 2. Buffer cannot be recognized. 	<ol style="list-style-type: none"> 1. Please adjust standard solution to appropriate temperature range. 2. Please check and clear electrode glass end of air bubbles. 3. Maintain or replace electrode and make another calibration.
Error5	Wrong passcode ERROR CODE	Re-enter the passcode.
Error9	Critical error that does not permit further measurements.	Please contact Sensorex service.

9. Maintenance

Under normal operation and conditions, the transmitter does not need maintenance other than scheduled cleaning and calibration of the electrode to ensure accurate measurements.

The cleaning cycle for the electrode depends on the measurement sample's degree of pollution. Typically, weekly cleaning is highly recommended. Refer to sensor manual for cleaning instructions.

Appendix

Table 1 TECH Buffers

TECH buffers			
TEMP°C	Buffer 4.01	Buffer 7.00	Buffer 10.00
5	3.999	7.087	10.241
10	3.998	7.053	10.155
15	3.999	7.031	10.116
20	4.002	7.011	10.047
25	4.006	6.996	9.998
30	4.011	6.985	9.952
35	4.018	6.976	9.925
40	4.031	6.971	9.874
45	4.047	6.969	9.843
50	4.055	6.969	9.810

Table 2 NIST Standard buffers

NIST standard buffers(DIN 19266)					
TEMP°C	Buffer 1.68	Buffer 4.01	Buffer 6.86	Buffer 9.18	Buffer 12.45
5	1.668	4.004	6.951	9.395	13.207
10	1.670	4.000	6.923	9.332	13.003
15	1.672	3.999	6.900	9.276	12.810
20	1.675	4.001	6.881	9.225	12.627
25	1.679	4.006	6.865	9.180	12.454
30	1.683	4.012	6.853	9.139	12.289
35	1.688	4.021	6.844	9.102	12.133
40	1.694	4.031	6.838	9.068	11.984
45	1.700	4.043	6.834	9.038	11.410
50	1.707	4.057	6.833	9.011	11.705



Sensorex Corporation

11751 Markon Drive
Garden Grove, CA 92841 USA Tel:
714-895-4344
Fax: 714-894-4839
e-mail: support@sensorex.com

www.sensorex.com