

Infrared thermometer

**testo 835 - fast, accurate
infrared measuring instruments
for trade and industry**

Measure safely and accurately even at high temperatures

4-point laser shows the exact measuring range, preventing incorrect measurements

Safe measurements from a long distance, thanks to 50:1 optics

Integrated emissivity measurement for absolute measuring reliability

Patented surface moisture measurement (testo 835-H1)

Convenient menu guidance with icons and joystick

Measuring value and location memory, and data analysis on the PC with free PC software "EasyClimate"



Take advantage of the benefits the testo 835 series has to offer, in virtually all sectors of trade and industry: e.g. monitoring wall temperature and humidity, inspecting air conditioning and ventilation systems, the maintenance of industrial systems or the quality control of industrially manufactured products.

Testo infrared measuring technology, which delivers first-class results even at long distance, is particularly helpful when monitoring the temperature of objects that are small, moving, difficult to access or extremely hot. The many features increase the room for manoeuvre, for example in the building trade when carrying out surface moisture measurement via infrared, or in the metal, glass and ceramics industry when measuring temperatures up to 1500 °C. So you can be certain of having everything under control and of safeguarding your standards of quality at all times.

Ordering data

testo 835-T1

Get started in the field of intelligent infrared measuring technology

Maximum safety and precision when measuring the temperature of smaller objects from a reasonable distance, e.g. monitoring wall temperature, troubleshooting in heating and air conditioning systems, or the quality control of industrially manufactured products.

testo 835-T2

The pro when it comes to high temperatures

Measure precise temperatures of up to 1500 °C from a safe distance thanks to its extended temperature measuring range, e.g. when monitoring product temperature in the glass, ceramics and metal industry.

testo 835-T1

testo 835-T1, infrared temperature measuring instrument, 4-point laser marking, measurement data administration, PC software, incl. batteries and calibration protocol

Part no. 0560 8351



testo 835-T2

testo 835-T2, infrared high temperature measuring instrument, 4-point laser marking, measurement data administration, PC software, incl. batteries and calibration protocol

Part no. 0560 8352



testo 835-H1

Special instrument with integrated humidity module

Use its unique, patented infrared surface moisture measurement feature to detect the risk of mould in building fabrics early enough, measure humidity or check the dew point distance, for example.

testo 835-H1

testo 835-H1, infrared temperature measuring instrument, 4-point laser marking, measurement data administration, PC software, humidity module, incl. batteries and calibration protocol

Part no. 0560 8353



Technical data

	testo 835-T1	testo 835-T2	testo 835-H1
Sensor type Infrared			
Optics	50:1 (regarding the distance of 2.0 m to measuring object typically) + opening diameter of the sensor (24 mm)		
Meas. spot marking	4 point laser		
Spectral range	8 to 14 μm		
Meas. range	-30 to +600 °C	-10 to +1500 °C	-30 to +600 °C
Accuracy ± 1 digit	$\pm 2,5$ °C (-30,0 to -20,1 °C) $\pm 1,5$ °C (-20,0 to -0,1 °C) $\pm 1,0$ °C (+0,0 to +99,9 °C) $\pm 1\%$ of mv (remaining range)	$\pm 2,0$ °C or $\pm 1\%$ of mv	$\pm 2,5$ °C (-30,0 to -20,1 °C) $\pm 1,5$ °C (-20,0 to -0,1 °C) $\pm 1,0$ °C (+0,0 to +99,9 °C) $\pm 1\%$ of mv (remaining range)
Resolution	0,1 °C	0,1 °C (-10,0 to +999,9 °C) 1 °C (+1000,0 to +1500,0 °C)	0,1 °C
Sensor type Type K (NiCr-Ni)			
Meas. range	-50 to +600 °C	-50 to +1000 °C	-50 to +600 °C
Accuracy ± 1 digit	$\pm (-0.5$ °C +0.5% of mv)		
Resolution	0.1 °C		
Sensor type Testo humid. sensor, cap.			
Meas. range	-	-	0 to 100 %RH
Accuracy ± 1 digit	-	-	± 2 %RH ± 0.5 °C
Resolution	-	-	0.1 °C 0.1 %RH 0.1 °Ctd

General technical data

Emissivity	0.10 to 1.00 (steps 0.01)
Emissivity table	20 values storable
Laser spot	On / off
Memory	200 values storable
Alarm (upper/lower limit)	IR temperature, TC temperature
Alarm signal	audible, optical
Oper. temp.	-20 to +50 °C
Storage temp.	-30 to +50 °C
Material/Housing	ABS + PC
Dimensions	193 x 166 x 63 mm
Weight	514 g
Battery type	3 batteries Type AA (or USB operating with PC-Software)
Battery life	25 h (typical 25°C without laser and backlight) 10 h (typical 25°C without backlight)
Display	Dot matrix
Auto-Off (disabled for continuous measurement and USB connection)	Backlight: 30 s Instrument: 120 s
Standards	EN 61326-1:2006
Warranty	2 years

Accessories

Accessories	Part no.	
Bracket	0440 0950	
USB connection cable instrument to PC	0449 0047	
Adhesive tape, e.g. for bare surfaces (roll, L.: 10 m, W.: 25 mm)	0554 0051	
Silicone heat paste (14g), Tmax = +260°C	0554 0004	
ISO calibration certificate/temperature; infrared thermometer; calibration points +60°C; +120°C; +180°C	0520 0002	
ISO calibration certificate/temperature; infrared thermometers, calibration points -18°C, 0°C, +60°C	0520 0401	
ISO calibration certificate/temperature; meas. instr. with air/immersion probe; cal. points 0°C; +150°C; +300°C	0520 0021	
Aluminium case for testo 835	0516 8450	
PC software "EasyClimate" for downloading from www.testo.com/download	-	

Information on contact measurement

- Observe the minimum penetration depth for immersion/penetration probes: 10x probe diameter
- Avoid using in aggressive acids or alkalis

Measuring range, distance

Depending on the distance of the measuring instrument from the measurement object, a specific measuring range is recorded.





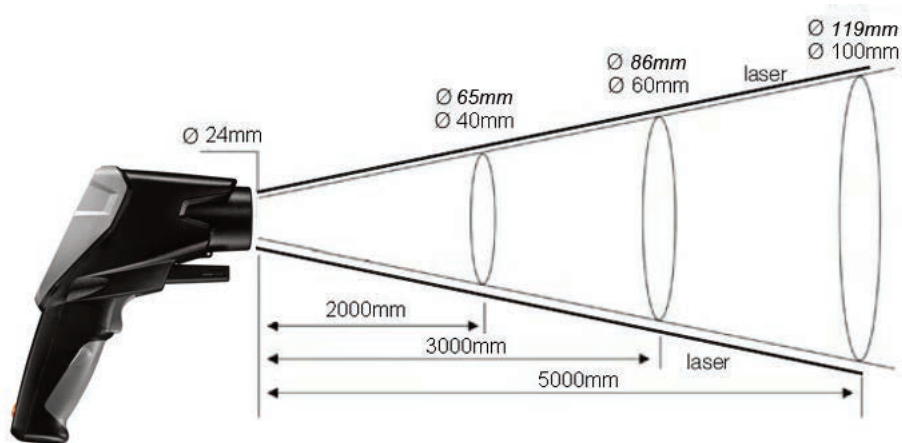

Measuring lens (ratio of distance : measuring range)

In italics = laser

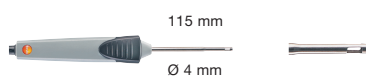
Not in italics = measuring range

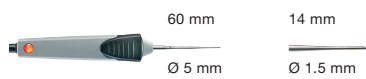

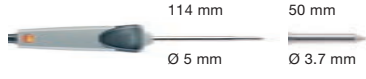
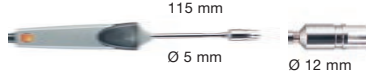
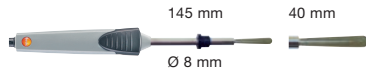
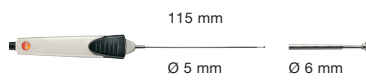

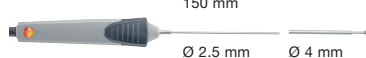



Probes

Probe type	Dimensions Probe shaft/probe shaft tip	Measuring range	Accuracy	t ₉₉	Part no.
Air probes					
Robust air probe, T/C Type K, Fixed cable 1.2 m		-60 to +400 °C	Class 2 ¹⁾	25 s	0602 1793
Immers./penetr. probes					
Efficient and fast-action immersion probe, waterproof, TC Type K, Fixed cable 1.2 m		-60 to +1000 °C	Class 1 ¹⁾	2 s	0602 0593
Fast-action, waterproof immersion/penetration probe, TC Type K, Fixed cable 1.2 m		-60 to +800 °C	Class 1 ¹⁾	3 s	0602 2693
Immersion tip, flexible, TC Type K (available only until 31. Dec. 2012)		-200 to +1000 °C	Class 1 ¹⁾	5 s	0602 5792
Waterproof immersion/penetration probe, TC Type K, Fixed cable 1.2 m		-60 to +400 °C	Class 2 ¹⁾	7 s	0602 1293
Surface probes					
Fast-action surface probe with sprung thermocouple strip, also for uneven surfaces, measurement range short-term to +500°C, TC Type K, Fixed cable 1.2 m		-60 to +300 °C	Class 2 ¹⁾	3 s	0602 0393
Fast-reaction paddle surface probe, for measurements in inaccessible places, e.g. narrow apertures and slots, TC Type K, Fixed cable		0 to +300 °C	Class 2 ¹⁾	5 s	0602 0193
Waterproof surface probe with widened measurement tip for flat surfaces, T/C Type K, Fixed cable 1.2 m		-60 to +400 °C	Class 2 ¹⁾	30 s	0602 1993
Fast-action surface probe with sprung thermocouple strip, bent, also for uneven surfaces, measurement range short-term to +500°C, TC Type K, Fixed cable 1.2 m		-60 to +300 °C	Class 2 ¹⁾	3 s	0602 0993
Efficient, waterproof surface probe with small measurement head for flat surfaces, TC Type K, Fixed cable 1.2 m		-60 to +1000 °C	Class 1 ¹⁾	20 s	0602 0693

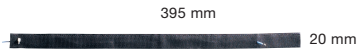
1) According to norm EN 60751, the accuracy of Classes 1 / 2 refers to -40 to +1000/+1200 °C.

Probes

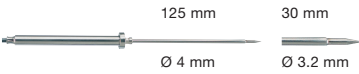
Probe type	Dimensions Probe shaft/probe shaft tip	Measuring range	Accuracy	t ₉₉	Part no.
Surface probes					
Flat head surface probe with telescopic handle max. 680 mm for measurements at hard-to-access points, TC Type K, Fixed cable 1.6 m (correspondingly shorter when telescope extended)		-50 to +250 °C	Class 2 ¹⁾	3 s	0602 2394
Magnetic probe, adhesive force approx. 20 N, with magnets, for measurements on metal surfaces, TC Type K, Fixed cable 1.6 m		-50 to +170 °C	Class 2 ¹⁾		0602 4792
Magnetic probe, adhesive force approx. 10 N, with magnets, for higher temp., for measurements on metal surfaces, TC Type K, Fixed cable 1.6 m		-50 to +400 °C	Class 2 ¹⁾		0602 4892
Pipe wrap probe with velcro strip; for temperature measurement on pipes with diameter up to max. 120 mm; Tmax. +120 °C; TC Type K, Fixed cable 1.5 m		-50 to +120 °C	Class 1 ¹⁾	90 s	0628 0020
Pipe wrap probe for pipe diameter 5 to 65 mm, with exchangeable measuring head. Meas. range short-term up to +280°C, TC Type K, Fixed cable 1.2 m		-60 to +130 °C	Class 2 ¹⁾	5 s	0602 4592
Spare meas. head for pipe wrap probe, TC Type K		-60 to +130 °C	Class 2 ¹⁾	5 s	0602 0092
Clamp probe for measurements on pipes, pipe diameter 15 to 25 mm (max. 1"), meas. range short-term up to +130°C, TC Type K, Fixed cable 1.2 m		-50 to +100 °C	Class 2 ¹⁾	5 s	0602 4692
Food probes					
Waterproof food probe made of stainless steel (IP65), TC Type K, Fixed cable 1.2 m		-60 to +400 °C	Class 2 ¹⁾	7 s	0602 2292

1) According to norm EN 60751, the accuracy of Classes 1 / 2 refers to -40 to +1000/+1200 °C.

