



testo 315 -1/2

Bedienungsanleitung

de

Instruction manual

en



Vorwort ..	2
Inbetriebnahme ..	3
Warnhinweise ..	3
Sicherheitshinweise ..	3
Geräteabbildung ..	4
Gerätebedienung ..	5
Messbeispiel ..	6
Gerät einschalten ..	6
Differenzdruck-Messung ..	7
Zugmessung ..	8
Differenztemperatur-Messung ..	9
Ionisationsstrom-Messung ..	10
CO-Messung ..	11
Alarmschwellen einstellen ..	12
Datum / Uhrzeit einstellen ..	13
Einheiten ändern ..	15
Wartung ..	16
Akku- oder Batteriewechsel ..	16
Sicherungswechsel ..	16
Fehlermeldungen ..	17
Technische Daten ..	18
Bestelldaten ..	19

Vorwort

Liebe Testo-Kundin, lieber Testo-Kunde,

Ihre Entscheidung für den Kauf des testo 315 war richtig.

Das testo 315-1 ist für das Einstellen und Warten von Gasheizungen konstruiert.

Jedes Jahr kaufen tausende Kunden unsere hochwertigen Produkte. Dafür sprechen mindestens 7 gute Gründe:

- 1) Bei uns stimmt das Preis-Leistungs-Verhältnis. Zuverlässige Qualität zum fairen Preis.
- 2) Deutlich verlängerte Garantiezeiten von bis zu 3 Jahren - je nach Gerät!
- 3) Mit der fachlichen Erfahrung von über 40 Jahren lösen wir Ihre Messaufgabe optimal.
- 4) Unser hoher Qualitätsanspruch ist bestätigt durch das Zertifikat nach ISO 9001.
- 5) Selbstverständlich tragen unsere Geräte das von der EU geforderte CE-Zeichen.
- 6) Kalibrier-Zertifikate für alle relevanten Meßgrößen. Seminare, Beratung und Kalibrierung vor Ort.
- 7) Auch nach dem Kauf lassen wir Sie „nicht im Regen stehen“.
Unser Service garantiert Ihnen schnelle Hilfe.

Messgerät konform zu EN 61 326-1 Klasse B: 1997, EN 61 326-1: 1997.



Messzelle

In der Messzelle befindet sich eine geringe Menge konzentrierter Säure (CO-Sensor). Diese Messzelle sollte als Sondermüll entsorgt werden.

Messgerät

Das Aufbewahren des Messgerätes in Räumen, in denen Lösungsmittel gelagert werden, führt zur Zerstörung der Messzelle.

Funktionsprüfung Differenzdruck

Bei der Differenzdruckmessung an gasführenden Leitungen darf kein Gas in das Gerät gelangen. Deshalb vor Gebrauch des Geräts grundsätzlich eine Funktionsprüfung durchführen (siehe Seite 7)

Funktionsprüfung CO-Messung

Vor Gebrauch des Geräts grundsätzlich eine Funktionsprüfung durchführen (siehe Seite 11).

Gerät darf nur von Fachpersonal eingesetzt werden.

Die örtlich geltenden Unfallverhütungs- und Prüfvorschriften sind zu beachten.

Sicherheitshinweise



Eine gleichzeitige Temperatur- und Ionisationsstrom-Messung ist nicht zulässig.

Das Gerät nicht in explosionsgefährdeten Bereichen einsetzen.

Das Gerät nur in dem unter Technische Daten spezifizierten Betriebs- und Messbereichen einsetzen.

Das Gerät darf nur unter den Bedingungen und für die Zwecke eingesetzt werden für die es konstruiert wurde. Hierzu sind besonders die Sicherheitshinweise und die Technischen Daten zu beachten.

Kapazitätsanzeige



Spannung >7,5 V
Standzeit Akku ca. 5 h
Standzeit Batterie ca. 15 h
(bei einer Umgebungstemperatur von 20°C)



blinkendes Symbol, Spannung <7,5 V
Standzeit Akku ca. ca. 15 min.
Standzeit Batterie ca. 45 min.
Sinkt die Akkuspannung unter 6,7 V erfolgt automatische Abschaltung als Schutz gegen Tiefentladung.

Inbetriebnahme

Geräteabbildung





Die Tastatur

- Blättertasten

Mit den **Pfeiltasten** auf  /ab  wird zwischen den Messgrößen hin- und hergeblättert bzw. die Zahlenwerte von Datum/Uhrzeit und den Alarmschwellen eingestellt.

- Auswahl taste

Mit der Pfeiltaste rechts  wird im Menü Datum/Uhr und Alarmschwellen auf die veränderbaren Parameter zugegriffen. Desweiteren können auch die Einheiten gewechselt werden. Mit den Tasten auf  und ab  erfolgt die Einstellung der Parameter.

- Drucken

Über die Taste **Drucken**  können alle gespeicherten Messwerte mit dem Drucker ausgedruckt werden.

- I/O-Taste

Mit der **I/O-Taste**  wird das Gerät ein- oder ausgeschaltet. Beim Ausschalten des Gerätes schaltet die Anzeige automatisch nach 5 Sekunden ab. Dies kann durch Drücken einer beliebigen Taste verhindert werden. Das Gerät springt dann in das 9p Messmenü.

Beim Ausschalten des Gerätes gehen die in der Anzeige dargestellten Messwerte generell verloren.

- Taste Abbruch

Über die Taste **Abbruch**  können Sie angewählte Vorgänge oder eine vorgenommene Auswahl abbrechen bzw. Untermenüs verlassen.

- Taste ok

Mit Taste  werden die geänderten Parameter gespeichert.

- Taste START/HOLD

Mit Taste  Messung beginnen. Bei wiederholter Betätigung der Taste  werden die angezeigten Messwerte festge-halten.

- Taste Alarm on/off

Akustisches Signal ein- oder ausschalten.

Messbeispiel: testo 315-1/-2

Gerät einschalten

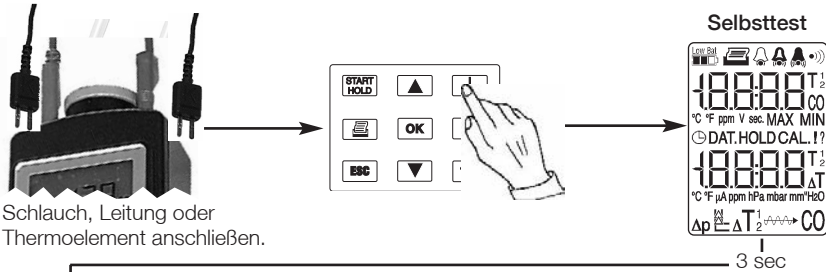

Anzeige Batterie-Kapazität / Geräteversion

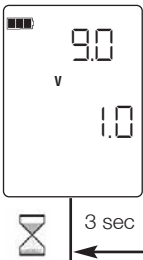

Geräteversion

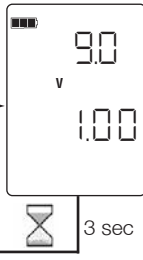

Selbsttest

Taste drücken. Anzeige aller Segmente für ca. 3 Sekunden.

Batterie-Kapazität / Geräteversion (2-stellig)

Anzeige der Batterie-/Akkuspannung und Geräteversion für ca. 3 Sekunden.

Geräteversion (3-stellig)

Wird innerhalb der 3 Sekunden die Taste betätigt, erscheint die Versionsnr. 3-stellig. Danach erfolgt Sprung in die Nullungsphase.

Nullungsphase



Die Verschlusskappe muß geschlossen sein. Ansonsten erscheint das Symbol !. Die Nullungsphase wird nicht begonnen.

Nach der Nullungsphase erfolgt automatischer Sprung in das Messmenü.

Messmenü

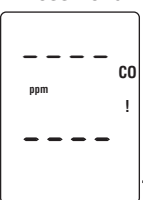

Funktionsprüfung CO-Messung



Vor Gebrauch des Geräts grundsätzlich eine Funktionsprüfung durchführen (siehe Seite 11).



5 sec → Gerät schaltet aus.

Messbeispiel: testo 315-1

Differenzdruck-Messung (Symbol: ΔP / Messbereich: 200 hPa)

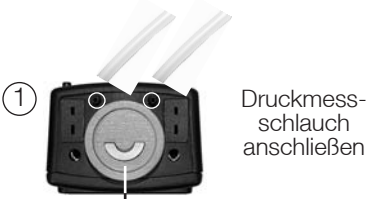

① Druckmessschlauch anschließen

Verschlusskappe CO muss geschlossen sein.

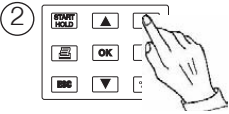

② Gerät einschalten.

- ③ - Segmenttest (3 sec.)
 - Spannungsanzeige (3 sec.)
 - Nullungsphase (60 sec.)
 (siehe Seite 6)
 - Funktionsprüfung für beide Drucknippel



Keine Messwert-Anzeige?
Messgerät zum Service einschicken.

Messmenü

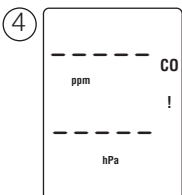

④



Verschlusskappe öffnen

CO sollte generell gemessen werden.

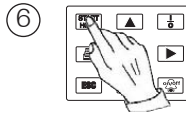

⑥ Messung starten.

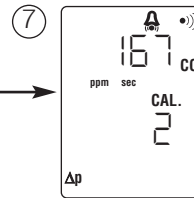

⑦ Nullungsphase abwarten (5 sec.)

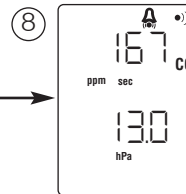

⑧ Druckmessschlauch plazieren. Im Display erscheint der Messwert.

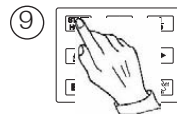

⑨ Messwert abspeichern. Im Display erscheint **HOLD**

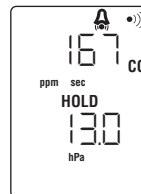

⑩ Die gespeicherten Messwerte können ausgedruckt werden.

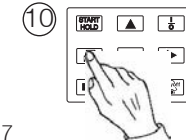

⑩ Die gespeicherten Messwerte können ausgedruckt werden.

Messbeispiel: testo 315-1

Zugmessung

Symbol:  /Messbereich: 40 hPa

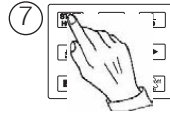

Messung starten.

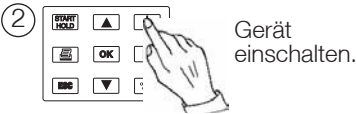

- ③ - Segmenttest (3 sec.)
 - Spannungsanzeige (3 sec.)
 - Nullungsphase (60 sec.)
 (siehe Seite 6)
 - Funktionsprüfung
 für beide Drucknippel
 (siehe Seite 7)

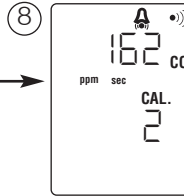

Nullungsphase abwarten (5 sec.)

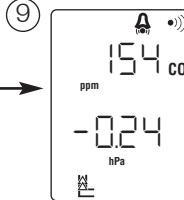

Sonde im Abgaskanal fixieren. Im Display erscheint der Messwert.

Messmenü

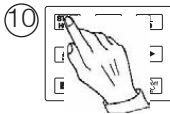
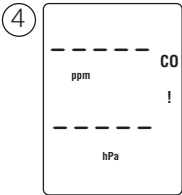

Messwert abspeichern. Im Display erscheint **HOLD**

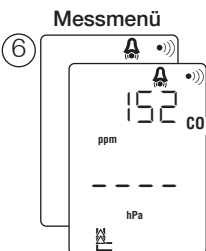
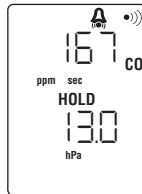

▲ Messmenü-Auswahl mit Pfeiltaste.
 OK
 ▼

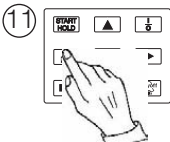

Die gespeicherten Messwerte können ausgedruckt werden.

Messbeispiel: testo 315-1

Differenztemperatur-Messung



Vor jeder Messung sicherstellen, dass die zu messende Oberfläche spannungsfrei ist. Bei Nichtbeachten Verletzungsgefahr für den Anwender bzw. Beschädigung des Geräts möglich.



Um Verbrennungen zu vermeiden darf das zu prüfende Objekt nur mit dem Temperaturfühler berührt werden.

Temperaturfühler anschließen

①



Verschlusskappe CO muss geschlossen sein.

②

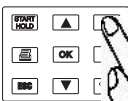

Gerät einschalten.

③

- Segmenttest (3 sec.)
- Spannungsanzeige (3 sec.)
- Nullungsphase (60 sec.)

(siehe Seite 6)

Messmenü

④

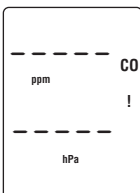

⑤



Verschlusskappe öffnen

CO sollte generell gemessen werden.

Messmenü

⑥

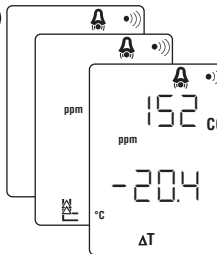

Messmenü-Auswahl mit Pfeiltaste.

⑦

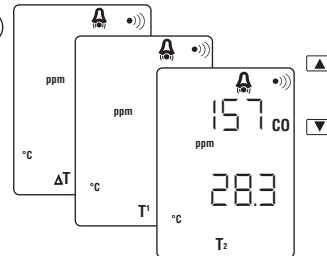

Die Messwerte T, T1, T2 können mit den Pfeiltasten abgerufen werden.

⑧

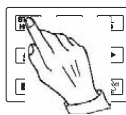

Messwert abspeichern.
Im Display erscheint **HOLD**

⑨

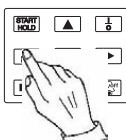

Die gespeicherten Messwerte können ausgedruckt werden.

Messbeispiel: testo 315-1

Ionisationsstrom-Messung



Messender muss ständig anwesend sein. Beim Ansetzen der Prüfklemmen kann sich ein Strom aufbauen, der das Warnsystem der Anlage unterbricht.



Um einen elektrischen Schlag zu vermeiden, sind unbedingt die geltenden Sicherheits- und VDE-Bestimmungen bezüglich zu hoher Berührungsspannung zu beachten, wenn mit Spannungen größer 120V (60V) DC oder 50V (25) eff AC gearbeitet wird. Die Werte in Klammern gelten für eingeschränkte Bereiche (wie z. B. Medizin, Landwirtschaft).

Messkabel anschließen
rot = + / Schwarz = -



Verschlusskappe CO muss geschlossen sein.

②  Gerät einschalten.

- ③ - Segmenttest (3 sec.)
 - Spannungsanzeige (3 sec.)
 - Nullungsphase (60 sec.)
- (siehe Seite 6)

④ **Messmenü**

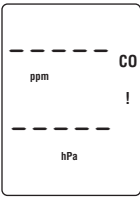

⑤  Verschlusskappe öffnen

CO sollte generell gemessen werden.

⑥ **Messmenü**

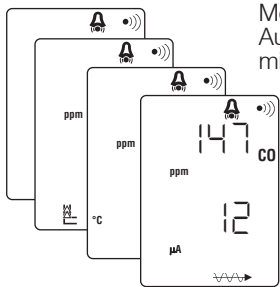

Messmenü-Auswahl mit Pfeiltaste.

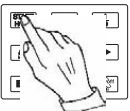
⑦  Messwert abspeichern.
Im Display erscheint **HOLD**

⑧  Die gespeicherten Messwerte können ausgedruckt werden.



- ③ - Segmenttest (3 sec.)
 - Spannungsanzeige (3 sec.)
 - Nullungsphase (60 sec.)

Die Nullungsphase (60 sek.) startet nur, wenn die CO-Kappe geschlossen ist (Rechtsdrehung). Wird während der Nullungsphase der CO-Verschluss geöffnet, beginnt die Nullung wieder bei 60 Sekunden, bis die Kappe wieder geschlossen wird.

(siehe auch Seite 6)

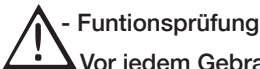

- Funktionsprüfung

Vor jedem Gebrauch des Geräts grundsätzlich eine Funktionsprüfung durchführen!

Das Gerät bei geschlossener CO-Kappe auf den Nullpunkt einstellen. Bei Öffnen der Kappe während des Nullens wird der Vorgang unterbrochen und mit erneutem Schließen wieder gestartet. Um die Funktionsfähigkeit des Sensors zu überprüfen, z.B. eine brennende Zigarette oder offene Gasflamme verwenden. Sensor nicht zu hohen Temperaturen aussetzen.

Die Funktionsprüfung muss den jeweiligen Sicherheitsvorschriften entsprechen. Ändert sich der Wert auf der Anzeigeskala des Geräts nicht, ist das Gerät defekt. Gerät zu weiteren Prüfungen nicht mehr einsetzen. Gerät zur genaueren Untersuchung an autorisierten Kundendienst schicken.

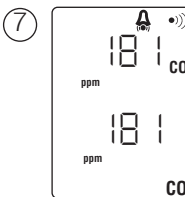
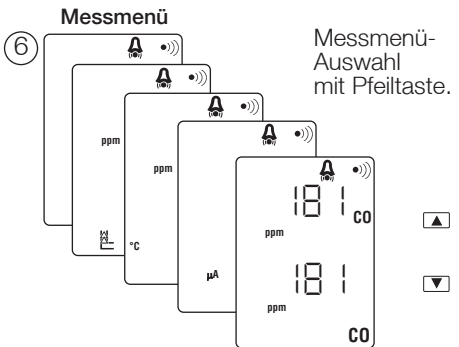
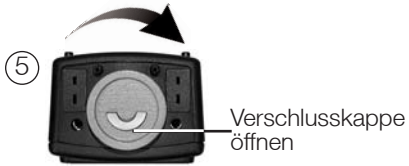
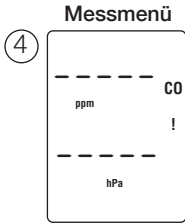

Der Messwert erscheint in der unteren Zeile im Display.

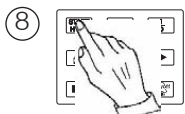

Messwert abspeichern.
 Im Display erscheint **HOLD**

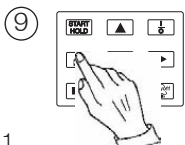

Die gespeicherten Messwerte können ausgedruckt werden.

Alarmschwellen einstellen

Differenzdruck (testo315-1), Zug (testo315-1),
CO (testo315-1/-2)

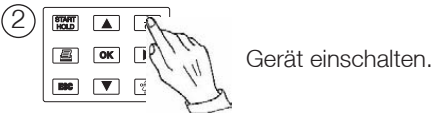

- ③ - Segmenttest (3 sec.)
- Spannungsanzeige (3 sec.)
- Nullungsphase (60 sec.)
(siehe Seite 6)

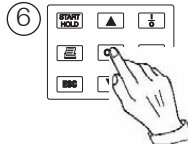
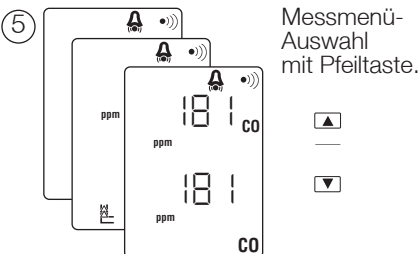
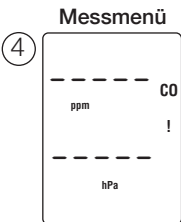

- ⑦ Differenzdruck

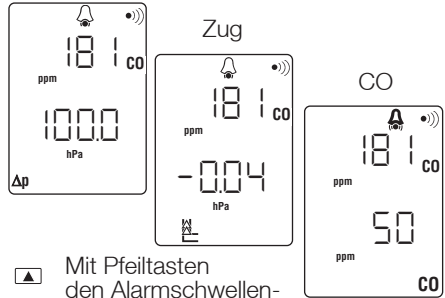

- ▲ Mit Pfeiltasten den Alarmschwellenwert erhöhen
- ▼ oder verringern.

CO hat 3 Alarmstufen. Diese können mit Taste  eingestellt werden.

Hinweis:

Wenn die Alarmschwelle den Wert 0000 hat ist der Alarm der entsprechenden Alarmschwelle ausgeschaltet. Der dP- bzw. Zugalarm ist nach der Nullung inaktiv geschaltet während der CO-Alarm aktiv bleibt. Dies wird mit dem blinkenden Symbol  signalisiert.

Mit der Taste  kann der dP- bzw. Zugalarm eingeschaltet werden.



Datum / Uhrzeit einstellen



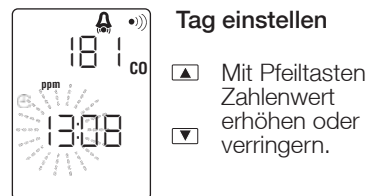
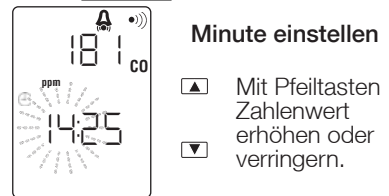
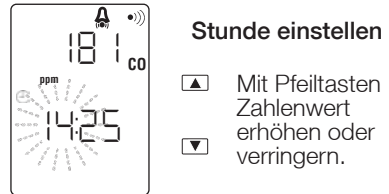
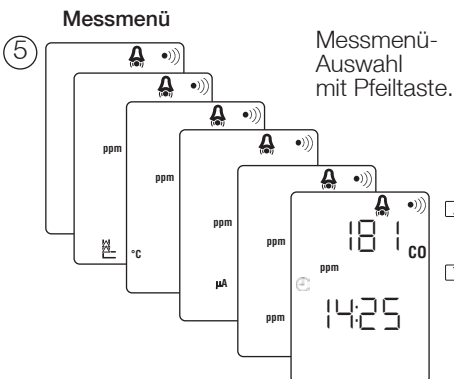
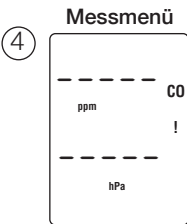

- ③ - Segmenttest (3 sec.)
 - Spannungsanzeige (3 sec.)
 - Nullungsphase (60 sec.)
 (siehe Seite 6)

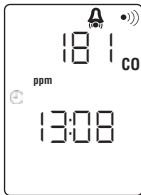

⑨ Taste  drücken



Monat einstellen

-  Mit Pfeiltasten Zahlenwert erhöhen oder verringern.
- 
- 

Hinweis:

Mit der Taste  kann die Datums-Anzeige von Tag/Monat (EUR) auf Monat/Tag (US) getauscht werden.

⑩ Taste  drücken

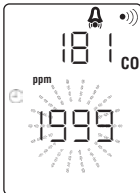

Jahr einstellen

-  Mit Pfeiltasten Zahlenwert erhöhen oder verringern.
- 
- 

⑪

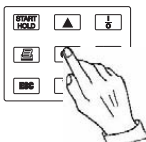

Zurück in Messmenü-Auswahl

Einheiten ändern (testo 315-1)

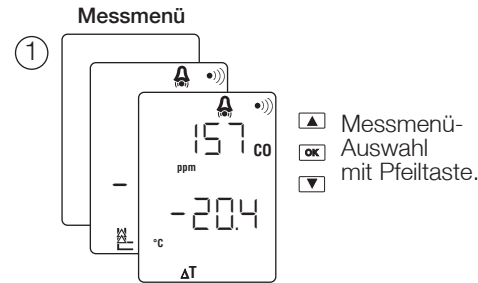

③ Einheiten auswählen:

Differenzdruck-Messung
hPa, mbar, mmH₂O, inchH₂O

Zugmessung
hPa, mbar, mmH₂O, inchH₂O

Differenztemperatur-Messung
°C, °F



Mit Taste **ESC** kann das Menü verlassen werden. Keine Übernahme von Änderungen.

Akku- oder Batteriewechsel

Wird das Gerät über einen längeren Zeitraum nicht benutzt, sollten die Akkus / Batterien entnommen werden. Bei Verunreinigungen des Geräts durch ausgelaufene Batteriezellen, Gerät zum Reinigen und Überprüfen in das Werk einschicken.

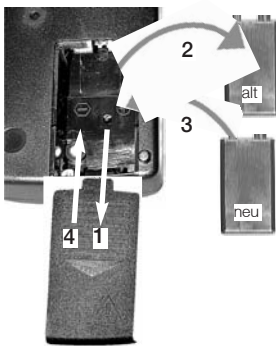

Vor Akku- oder Batteriewechsel das Gerät ausschalten und von allen angeschlossenen Messkreise trennen.

Datum/Uhrzeit wird beim Ausschalten des Gerätes gespeichert.

Es dürfen nur die in den Technischen Daten spezifizierten Akkus/Batterien verwendet werden.

Leere/defekte Akkus bzw. leere Batterien aus dem Batteriefach entnehmen und durch neue Akkus oder Batterien ersetzen.



Auf richtige Polarität der Akkus oder der Batterien achten!
Gerät darf nur mit geschlossenem Batteriedeckel betrieben werden!.

Sicherungswechsel (nur bei testo 315-1)

Vor Sicherungswechsel das Gerät ausschalten und von allen angeschlossenen Messkreise trennen.

Es darf nur die in den Technischen Daten spezifizierte Sicherung verwendet werden.



Das Verwenden von Behelfssicherungen, insbesondere das Kurzschließen der Sicherungshalter, ist unzulässig und kann die Zerstörung des Geräts und schwerwiegende Verletzungen des Bedienpersonals verursachen.

Gerät darf nur mit geschlossenem Sicherungsdeckel betrieben werden!

1 Deckel öffnen



2 Sicherung entnehmen



3 Ersatz-Sicherung einsetzen

Überprüfung der Sicherung





Der mit einem Ohmmeter gemessene Widerstand an den Anschlüssen der Sicherung muss im Ohmbereich liegen.

4 Deckel kräftig schließen bis zum Einrastgeräusch



Fehlermeldungen

Phase	Symbol	Ursache
Allgemein	Low Bat blinkt 	Geräteversorgung zu niedrig. Sinkt die Batteriespannung unter 6.7 Volt, erfolgt automatische Abschaltung.
	T in oberer Zeile blinkt	Unzulässige Umgebungstemperatur » Umgebungstemperatur anpassen.
	In unterer Zeile erscheint die Meldung Exxx	Gerät an Service schicken.
Nullungsphase	? blinkt und oberes CO-Symbol blinkt	Am Sensor befindet sich eine zu hohe CO-Konzentration
	? und oberes CO-Symbol blinkt	Messung des CO-Signals in der Nullungsphase nicht stabil. » Mehrmaliges Durchlaufen der Nullungsphase abwarten. Bringt dies keinen Erfolg ist die CO-Zelle defekt. » Gerät an Service schicken.
	! Sensors schließen.	Verschlusskappe ist nicht richtig geschlossen. » Verschlusskappe zum Nullen des CO-
Ionisationsstrom-Messung 	Statt dem Messwert werden nur Striche angezeigt. -----	1. Ein oder beide Temperaturfühler sind noch gesteckt. Abhilfe: Alle Temperaturfühler am Gerät ausstecken. 2. Strom zu groß
T1, T2, ΔT-Messung 	Statt dem Messwert werden nur Striche angezeigt. -----	1. Zu niedrige oder zu hohe Temperatur 2. Temperaturfühler fehlerhaft 3. Temperaturfühler nicht gesteckt.
Nach Nullungsphase	!	Verschlusskappe ist geschlossen, es werden Striche statt dem CO-Wert gezeigt. » Verschlusskappe öffnen

testo 315-1

CO-Messung

Messbereich: 0...2000 ppm
 Genauigkeit: 10 ppm (0...100 ppm)
 10 % v. Mw. (>100 ppm)

Auflösung: 1 ppm
 Alarmschwellen: 50 / 100 / 500 ppm
 (Werkseinstellung)

Alarmanzeige: akustischer und optischer
 Alarm bei Erreichen der
 Grenzwerte

Differenzdruck-Messung (³P)

Messbereich: ±200 hPa
 Genauigkeit: ±0,5 hPa (0...50 hPa)
 ±2 hPa (>50 hPa)

Auflösung: 0,1 hPa
 Alarmschwelle: 100 hPa,
 Einstellungsschritt 5 hPa
 (Werkseinstellung)

Alarmanzeige: akustischer und optischer
 Alarm bei Erreichen der
 Grenzwerte

Max. Überlast: 1 bar

Zugmessung

Messbereich: ±40 hPa
 Genauigkeit: < 3,00 hPa ±0,03 hPa
 > 3,00 hPa ±1,5% v. Mw.

Auflösung: 0,01 hPa
 Alarmschwelle: -0,04 hPa,
 Einstellungsschritt 0,01 hPa
 (Werkseinstellung)

Alarmanzeige: akustischer und optischer
 Alarm bei Erreichen der
 Grenzwerte

Max. Überlast: 1 bar

Temperaturmessung

Messbereich: -40...+600 °C
 Genauigkeit: ±0,5 °C (0...+99,9 °C)
 ±0,5 % v. Mw. (ab +100 °C)

Auflösung: 0,1 °C

Ionisationsstrom-Messung

Messbereich: ±100µA
 Genauigkeit: ±3 µA
 Auflösung: 1 µA

Allgemeine technische Daten

Lagertemperatur: -20...+60 °C
 Betriebstemp.: +5...+45 °C
 Abmessungen: 215 x 68 x 47 mm
 Gewicht: ca. 400 g

Überlastschutz

Sicherung: 50mA, 125V,
 Super Flink FF

testo 315-2

CO-Messung

Messbereich: 0...2000 ppm
 Genauigkeit: 10 ppm (0...100 ppm)
 10 % v. Mw. (>100 ppm)

Auflösung: 1 ppm
 Alarmschwellen: 50 / 100 / 500 ppm
 (Werkseinstellung)

Alarmanzeige: akustischer und optischer
 Alarm bei Erreichen der
 Grenzwerte

Allgemeine technische Daten

Lagertemperatur: -20...+60 °C
 Betriebstemp.: +5...+45 °C
 Abmessungen: 215 x 68 x 47 mm
 Gewicht: ca. 400 g

Stromversorgung testo 315-1/-2

Standard-Akkus oder Batterien

Batteriebetrieb: mit 9-Volt Blockbatterie,
 Alkali-Mangan
 IEC 6LR61
 Akkubetrieb: mit Testo-Akku
 (Best.-Nr. 0515.0025),
 Typ Ni-MH IEC 6F22.

Garantie testo 315-1/-2

Gerät:	24 Monate
Sonden:	12 Monate
Zubehör	6 Monate
CO-Messzelle	12 Monate
Drucker	12 Monate (außer Druckwerk)

Bestelldaten

testo 315

Beschreibung	Bestell-Nr.
Gerät	
testo 315-1 Gas-Sicherheits-Messgerät inkl. Bedienungsanleitung und Batterie	0632.0315
testo 315-2 Sicherheits-Messgerät für CO-Messung inkl. Bedienungsanleitung und Batterie	0632.0317
Fühler	
Prüfkabel mit Klemmen zur Ionisationsstrom-Messung	0554.0551
Zangen-Fühler für die schnelle Messung der Vor- und Rücklauf-temperatur bis max. +100 °C, Rohrdurchmesser max. 1y	0602.4692
Rohranlegefühler mit Klettband bis max. 120 °C	0628.0020
Zubehör	
Testo Protokolldrucker , Messdaten mit Messort, Datum und Uhrzeit dokumentieren	0554.0545
Ersatz-Rollen für Protokolldrucker	0554.0569
Akku	0515.3120
Ladegerät für 9 V-Akku	0554.0025
Ladegerät für Drucker	0554.0110
Druckset mit Kaminsonde	0554.3150
TopSafe , unverwüstliche Schutzhülle	0516.0443
Bereitschaftstasche	0516.0191
Service-Koffer	0516.3120
Ersatzteile	
Feinsicherung	0554.0406



testo 315 - 1/2

Bedienungsanleitung

de

Instruction manual

en



Foreword	2
Operation	3
Warnings	3
Safety instructions	3
Instrument diagram	4
Instrument operation	5
Measurement example	6
Switching on instrument	6
Differential pressure measurement	7
Draught measurement	8
Differential temperature measurement	9
Ionisation current measurement	10
CO measurement	11
Setting the alarm limits	12
Setting date/time	13
Changing the units	15
Maintenance	16
Changing rechargeable battery or battery	16
Changing the fuse	16
Error messages	17
Technical data	18
Ordering data	19

Foreword

Dear Customer

You have made the right decision by purchasing a testo 315 instrument.

testo 315-1 is designed to adjust and maintain gas heating systems.

Thousands of customers purchase our high standard products every year. There are at least 7 good reasons for doing so:

- 1) The cost-performance ratio is first-class: reliable quality at a fair price
- 2) Warranty times have been extended by up to 3 years - depending on the instrument.
- 3) We can find the best measuring solution for you using our expert experience gained over more than 40 years.
- 4) Our high demand on quality is confirmed by the ISO 9001 certificate.
- 5) Of course, our instruments also carry the CE symbol required by the EU.
- 6) Calibration certificates for all relevant parameters. Advice and calibration available on location.
- 7) We are also at your service following purchase.

Measuring instrument conforms with EN 61 326-1 Class B: 1997, EN 61 326-1: 1997



Measurement cell

There is a small amount of concentrated acid (CO sensor) in the measurement cell. This measurement cell should be disposed of responsibly.

Measuring instrument

Storage of the measuring instrument in rooms in which solvents are stored can lead to damage in the measurement cell.

Function test/Differential pressure

Gas should not get into the instrument when measuring the differential pressure in gas pipes. Therefore a function test should always be carried out before using the instrument (see page 7)

Function test/CO measurement

A function test should always be carried out before using the instrument (see page 11).

The instrument should only be used by trained personnel.

Please observe accident prevention and test guidelines.

Safety instructions



Simultaneous temperature and ionisation current measurement is not allowed.

The instrument should not be used in potentially explosive areas.

The instrument should only be used in the operation and measurement ranges specified in the technical data.

The instrument should only be used in the conditions and for the purposes for which it was designed. Please take particular note of the safety instructions and the technical data.

Capacity display

Voltage >7.5 V (Battery life:

Rechargeable battery life: approx. 5 h

Battery life: approx. 15 h

at an ambient temperature of 20°C)



Flashing symbol, voltage <7.5 V

Rechargeable battery life: approx. 15 min.

Battery life: approx. 45 min.

If the rechargeable battery voltage drops below 6.7 V, the instrument switches itself off automatically as protection against total discharge.

Low Bat



Operation

Instrument diagram

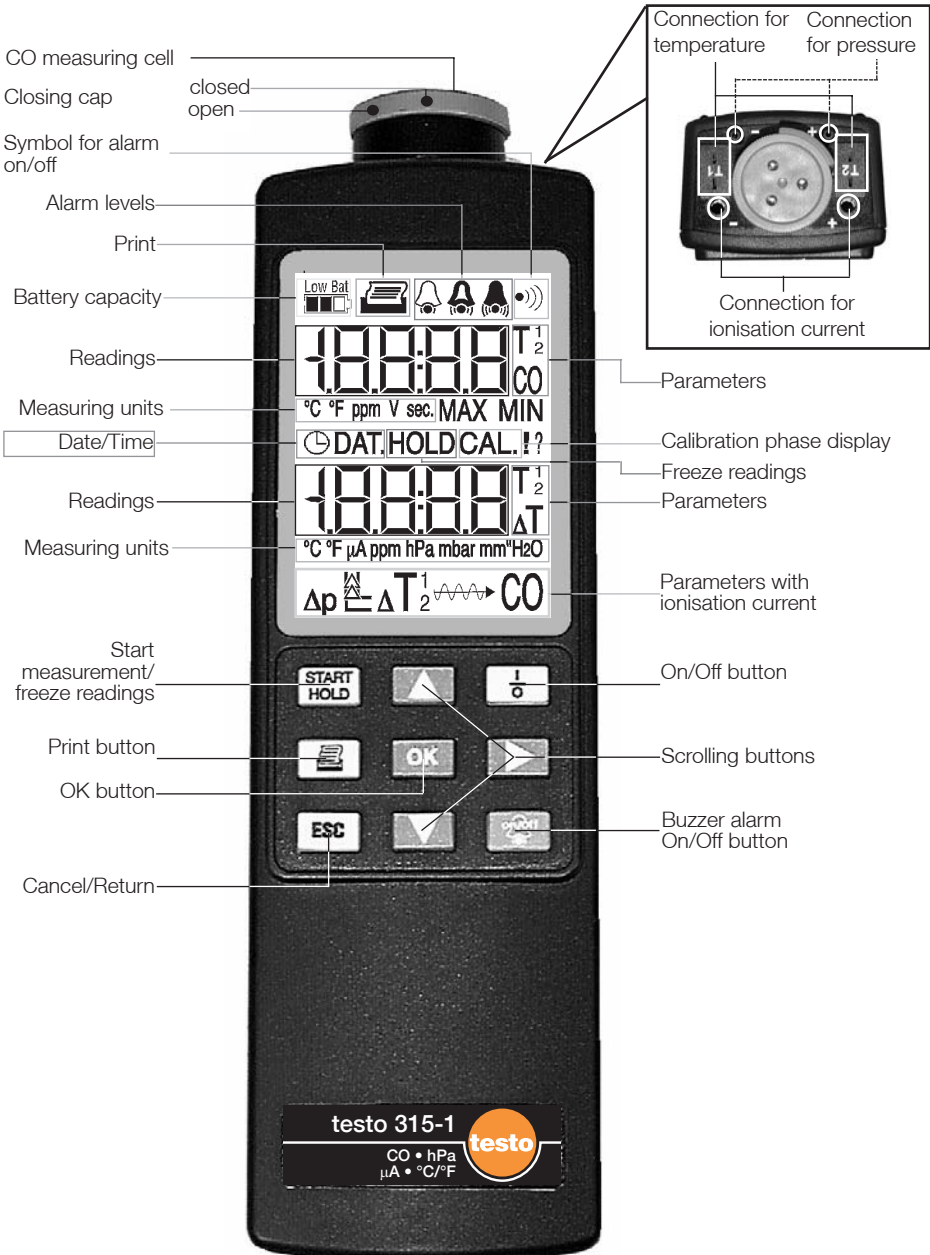



The button panel

- Scrolling buttons

Using the up  /or down  arrow buttons you can scroll between the parameters, adjust the date/time and set the alarm limits.

- Selection button

The adjustable parameters in the date/clock menu and the alarm limits can be accessed using the right arrow button .

The units can also be changed. Parameters are set via  and .

- Printing

All of the saved readings can be printed on the printer via the **Print**  button.

- I/O button

The instrument can be switched on or off using the I/O  button. The display switches off automatically after 5 seconds once the instrument is switched off. This can be prevented by pressing any key. The instrument then goes to the ρ measurement menu.

Once the instrument is switched off, the readings shown in the display are lost.



- Cancel button

You can cancel selected procedures or an option or exit sub-menus via the **Cancel**  button.

- ok button

The changed parameters are saved via .

- START/HOLD button

Start the measurement by pressing the  button. The displayed readings are frozen by pressing the  again.

- Alarm on/off button

Switches buzzer signal on or off.

Measurement example: testo 315-1/-2

Switching on instrument

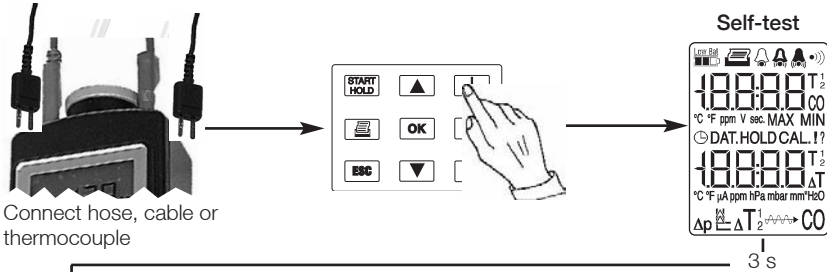

Display for battery capacity/instrument version

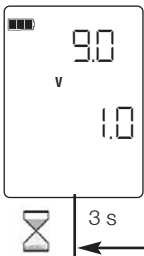

Instrument version

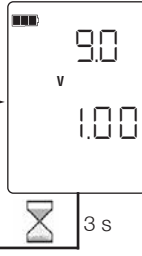

Self-test

Press $\frac{1}{0}$ button. Displays all segments for approx. 3 seconds.

Battery capacity / Instrument version (2 digit)

Displays battery/rechargeable battery voltage and instrument version for approx. 3 seconds.

Instrument version (3 digit)

If the **OK** is pressed within 3 seconds, the 3 digit version number appears. The instrument then goes to the initialisation phase.

Initialisation phase

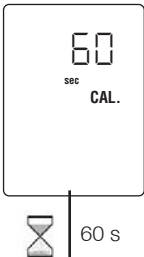

Initialisation phase

The initialisation phase takes 60 seconds. The **CAL** symbol appears in the display as information.



The sealing cap must be closed. Otherwise the ! symbol will appear. The initialisation phase will not begin.

After the initialisation phase, the instrument automatically goes to the measurement menu.

Measurement menu

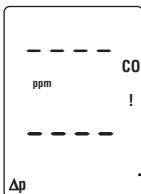

Function test/CO measurement

A function test should always be carried out prior to use (See page 11).



5 s

Instrument switches off.

Measurement example: testo 315-1

Differential pressure measurement (Symbol: ΔP / Measuring range: 200 hPa)

①  Connect pressure measurement hose

The CO sealing cap must be closed.

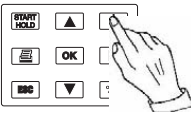
②  Switch on instrument

- ③ - Segment test (3 s)
- Voltage display (3 s)
- Initialisation phase (60 s)
(see page 6)
- Function test
for both pressure nipples



No reading display?
Send instrument in for service.

Measurement menu

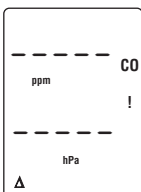
④ 

⑤  Open sealing cap

CO should always be measured.

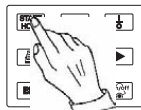
⑥  Start measurement.

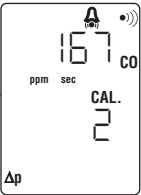
⑦  Wait on initialisation phase (5 s)

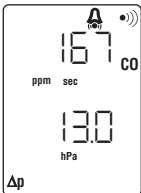
⑧  Position pressure measurement hose. The reading appears in the display.

⑨  Save reading. **HOLD** appears in the display.

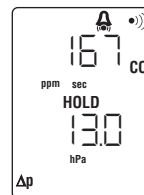

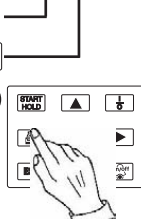
⑩  The readings saved can be printed.

Measurement example: testo 315-1

Draught measurement

Symbol:  / Measurement menu: 40 hPa



Connect probe

The CO sealing cap must be closed

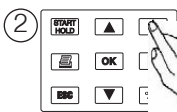

Switch on instrument.

- ③ - Segment test (3 s)
- Voltage display (3 s)
- Initialisation phase (60 s)
(see page 6)
- Function test
for both pressure nipples
(see page 7)

Measurement menu

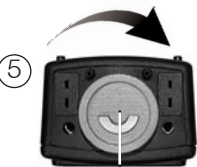
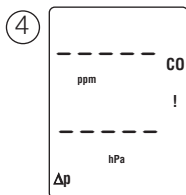



CO should always be measured.

Open sealing cap

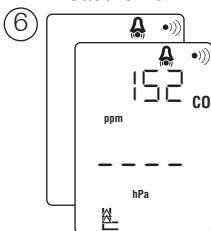
Measurement menu



 Measurement menu selection with arrow button.

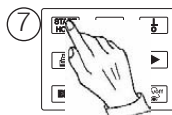

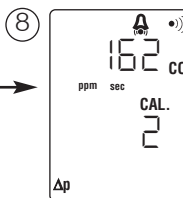

Start measurement

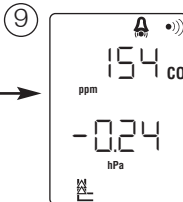

Wait on initialisation phase (5 s)



Position probe in flue gas duct. The reading appears in the display.

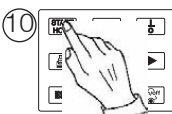

Save reading. **HOLD** appears in the display

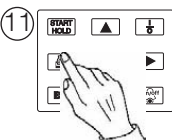
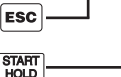
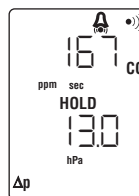

The saved readings can be printed.

Measurement example: testo 315-1

Differential temperature measurement



Please ensure, prior to every measurement, that the surface to be measured is dead. Non-adherence can lead to injury to the user or damage to the instrument.



To avoid burns, the object being tested should only be touched with a temperature probe.

Connect temperature probes

①



The CO sealing cap must be closed.

②



Switch on instrument.

③

- Segment test (3 s)
- Voltage display (3 s)
- Initialisation phase (60 s)

(see page 6)

Measurement menu

④

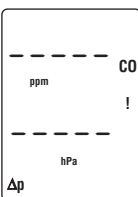

⑤



Open sealing cap

CO should always be measured

Measurement menu

⑥

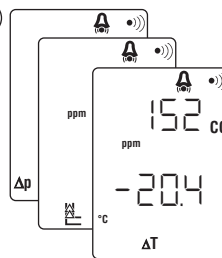

Measurement menu selection with arrow button.

⑦

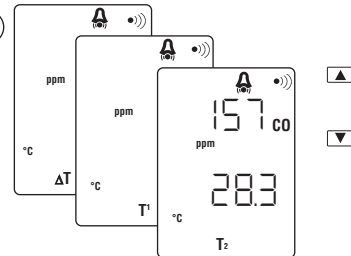

The T, T1, T2 readings can be called up via the arrow buttons.

⑧

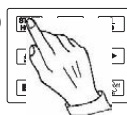

Save reading. **HOLD** appears in display

⑨

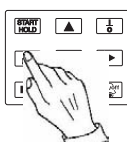

The saved readings can be printed.

Measurement example: testo 315-1

Ionisation current measurement

 The person measuring must be present at all times. Current can build up when the test clips are attached leading to disturbances in the instrument warning system.

 To avoid an electric shock it is absolutely imperative that the safety and VDE (Association of German Electrotechnical Engineers) stipulations on shock-hazard voltage are observed when working with voltages greater than 120V (60V) DC or 50V (25) eff AC. The values in brackets apply to limited sectors (such as Medicine, Agriculture).

Connect measurement cable
red = + / black = -



CO sealing cap must be closed.

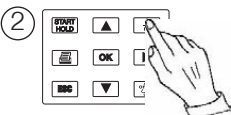

Switch on instrument

- ③ - Segment test (3 s)
 - Voltage display (3 s)
 - Initialisation phase (60 s)
- (see page 6)

Measurement menu

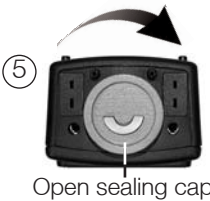
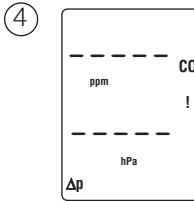

CO should always be measured.

Measurement menu

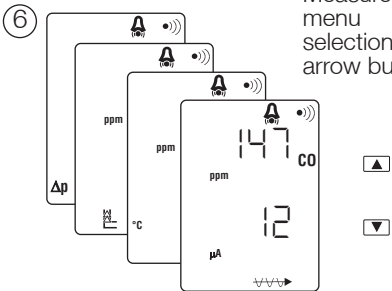

Measurement menu selection via arrow button

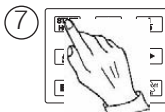

Save reading.
HOLD appears in the display.

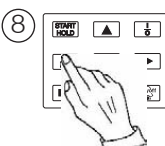

The saved readings can be printed.

Measurement example: testo 315-1/-2

CO measurement

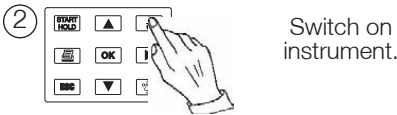

- ③ - Segment test (3 s)
- Voltage display (3 s)
- Initialisation phase (60 s)

The initialisation phase (60 s) will only begin if the CO cap is closed (turn to the right). If the CO seal is closed during the initialisation phase, initialisation will begin 60 seconds later until the cap is closed again.

(See page 6)



- Function test

A function test should always be carried out before using the instrument.

Set instrument to zero with the CO cap closed. If the cap is opened while initialising, the procedure will be interrupted and will be restarted once the cap is closed.

Use a lit cigarette or an open flame, for example, to check the sensor's functioning. The sensors should not be subjected to too high a temperature during this test.

The function test should be carried out in accordance with respective safety regulations. If the value on the display does not change, the instrument is defect. Do not use instruments for further tests. Send instrument to an authorised service point for inspection purposes.

Measurement menu

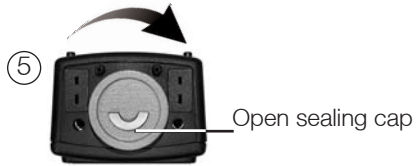
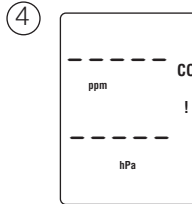

Measurement menu

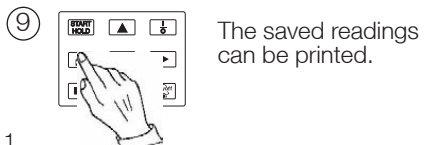
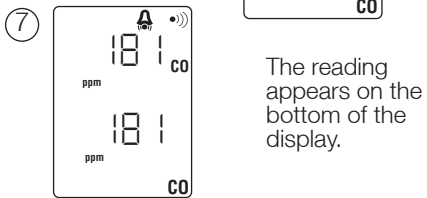
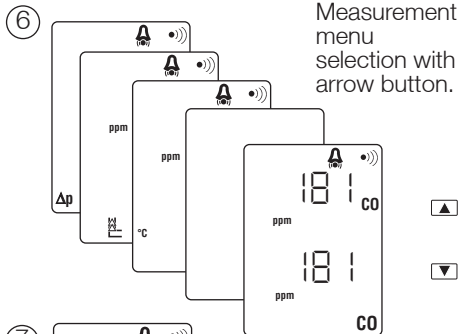

Setting the alarm limits

Differential pressure (testo315-1), draught (testo315-1), CO (testo315-1/-2)



Close CO sealing cap.

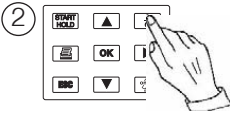

Switch on instrument

- ③ - Segment test (3 s)
 - Voltage display (3 s)
 - Initialisation phase (60 s)
- (see page 6)

Measurement menu

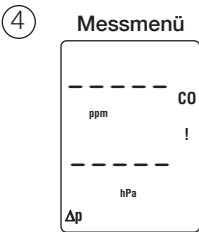

Measurement menu selection with arrow button.

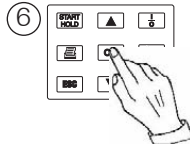
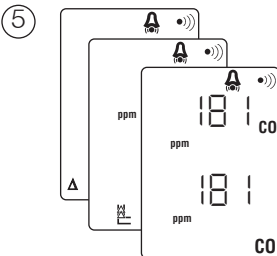

- ⑦ Differential pressure

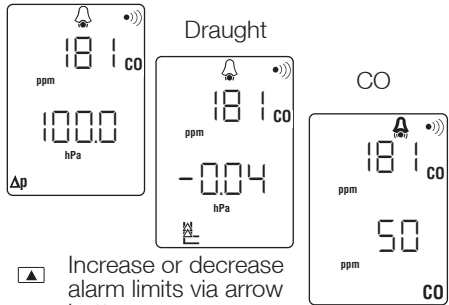

- ▲ Increase or decrease alarm limits via arrow buttons.
- ▼

CO has 3 alarm levels. These can be set with the ► button.

Note:

If the alarm limit has the value 0000 the alarm of the corresponding alarm limit is switched off. The dP or draught alarm is switched to inactive following initialisation while the CO alarm remains activated. This is signalled by the flashing ●))) symbol.

The dP or draught alarm can be switched on via .

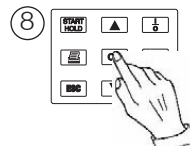

Automatic jump to measurement menu.



Setting date/time

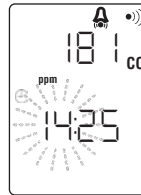
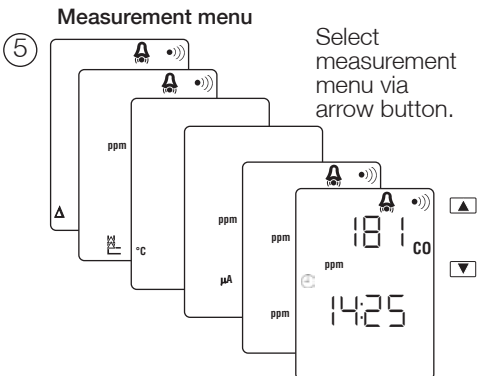
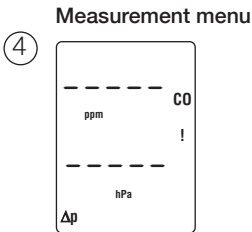

- ③ - Segment test (3 s)
- Voltage display (3 s)
- Initialisation phase (60 s)
(see page 6)



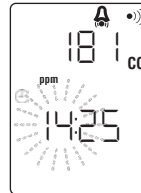

Setting the hour

-  Increase or decrease value via arrow buttons.



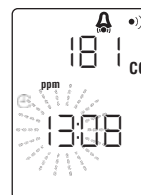

Setting minutes

-  Increase or decrease value via arrow buttons.





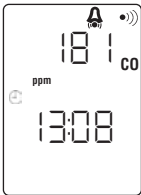

Setting the data

-  Increase or decrease value via arrow buttons.



- ⑨ Press  button



Setting the month

-  Increase or decrease value via arrow buttons.
-  OK
-  Decrease value via arrow buttons.



Note:

The date can be changed from day/month (EUR) to month/day (US) via the  button.

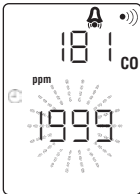
- ⑩ Press  button



Setting the year

-  Increase or decrease value via arrow buttons.
-  OK
-  Decrease value via arrow buttons.

⑪

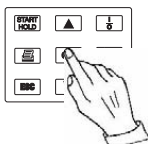

Return to measurement menu selection

Changing the units (testo 315-1)

Measurement menu

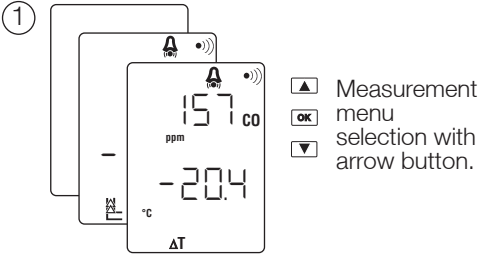

② Press  button

③ Selecting units:

Differential pressure measurement

hPa, mbar, mmH₂O, inchH₂O

Draught measurement

hPa, mbar, mmH₂O, inchH₂O

Differential temperature measurement

°C, °F



Exit the menu by pressing **ESC**. Modifications are not applied.

Changing rechargeable battery or battery

Remove rechargeable batteries/batteries if the instrument is not used for a longer period of time. If the battery cells leak in the instrument, return instrument to factory to be cleaned and checked.

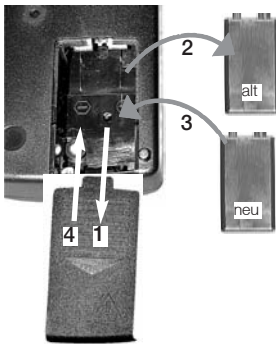

Switch off instrument and disconnect from all measuring circuits before changing the rechargeable battery or battery.



Date and time are saved when the instrument is switched off.

Only the rechargeable batteries/batteries specified in the technical data should be used.

Remove empty/defect rechargeable batteries or empty batteries from the battery compartment and replace with new ones.



Observe correct polarisation of rechargeable batteries or batteries.

Instrument should only be used if the battery compartment cover is closed.

Changing the fuse (only in testo 315-1)

Switch off instrument and disconnect from all measuring circuits before changing the fuse.

Only the fuse specified in the technical data should be used.



The use of provisional fuses and in particular the short-circuiting of fuse holders is not permitted and can destroy the instrument and cause serious injury to the user of the instrument.

Instrument should only be operated if the fuse compartment cover is closed.

1 Open the cover



2 Remove fuse



3 Put in spare fuse

Checking the fuse





The resistance in the connections of the fuse, measured with an ohmmeter, must be in the ohm range.

4 Close cover by pressing down until the clicking noise is heard



Error messages

Phase	Symbol	Cause
General	Low Bat flashes Low Bat 	Instrument power is too low. If the battery power drops below 6.7 volt, the instrument is automatically switched off.
	T in top line flashes	Non-permitted ambient temperature » adapt ambient temperature.
	The message Exxx appears in the bottom line	Send instrument for service.
Initialisation phase	? flashes and the CO symbol flashes	The CO concentration at the sensor is too high
	? and the top CO symbol flash	Measurement of the CO signal is not stable during the initialisation phase. » Wait for the initialisation phase to be run through several times. If it is not successful the CO cell is defect. » Send instrument in for service.
	!	Sealing cap is not closed properly. » Close sealing cap to initialise the CO sensor.
Ionisation current measurement 	Dashes are shown instead of reading. - - - -	1. One or both temperature probes are still in place. Remedy: Remove all temperature probes from instrument. 2. Current is too high
T1, T2, ΔT measurement 	Dashes are shown instead of reading. - - - -	1. Temperature too high or too low 2. Temperature probe defect 3. Temperature probe not in position.
After initialisation phase	!	Sealing cap is closed, dashes are shown instead of reading. » open sealing cap

If we were unable to answer your question, please contact your distributor or Testo Customer Service. You will find contact details in the Warranty booklet or in Internet at www.testo.com.

testo 315-1

CO measurement

Meas. range: 0 to 2000 ppm
 Accuracy: 10 ppm (0 to 100 ppm)
 10 % of m.v. (>100 ppm)
 Resolution: 1 ppm
 Alarm limits: 50 / 100 / 500 ppm
 (factory setting)
 Alarm display: Acoustic and optical alarm
 when limit values are reached

Differential pressure measurement (ΔP)

Meas. range: ± 200 hPa
 Accuracy: ± 0.5 hPa (0 to 50 hPa)
 ± 2 hPa (>50 hPa)
 Resolution: 0.1 hPa
 Alarm limit: 100 hPa,
 Setting in steps of 5 hPa
 (factory setting)
 Alarm display: Acoustic and optical
 alarm when limit values are
 reached
 Max. overload: 1 bar

Draught measurement

Meas. range: ± 40 hPa
 Accuracy: < 3.00 hPa ± 0.03 hPa
 > 3.00 hPa $\pm 1.5\%$ of m.v.
 Resolution: 0.01 hPa
 Alarm limit: - 0.04 hPa,
 Setting in steps of 0.01 hPa
 (factory setting)
 Alarm display: Acoustic and optical alarm
 when limit values are reached
 Max. overload: 1 bar

Temperature measurement

Meas. range: -40 to +600 °C
 Accuracy: ± 0.5 °C (0 to +99.9 °C)
 ± 0.5 % of m.v. (from +100 °C)
 Resolution: 0.1 °C

Ionisation current measurement

Meas. range: ± 100 μ A
 Accuracy: ± 3 μ A
 Resolution: 1 μ A

General technical data

Storage temperature: -20 to +60 °C
 Operating temperature: +5 to +45 °C
 Dimensions: 215 x 68 x 47 mm
 Weight: Approx. 400 g

General technical data

Storage temp.: -20 to +60 °C
 Operating temp.: +5 to +45 °C
 Dimensions: 215 x 68 x 47 mm
 Weight: Approx. 400 g

Overload protection

Fuse: 50mA, 125V,
 Super Flink FF

testo 315-2

CO measurement

Meas. range: 0 to 2000 ppm
 Accuracy: 10 ppm (0 to 100 ppm)
 10 % of m.v. (>100 ppm)
 Resolution: 1 ppm
 Alarm limits: 50 / 100 / 500 ppm
 (factory setting)
 Alarm display: Acoustic and optical alarm
 when limit values are reached

General technical data

Storage temperature: -20 to +60 °C
 Operating temperature: +5 to +45 °C
 Dimensions: 215 x 68 x 47 mm
 Weight: Approx. 400 g

Power supply in testo 315-1/-2

Standard rechargeable batteries or batteries
 Battery operation: With 9 volt block battery,
 alkali manganese
 IEC 6LR61
 Rechargeable battery: With Testo rechargeable
 battery
 (Part no. 0515.0025),
 Type Ni-MH IEC 6F22.

Warranty testo 315-1/-2

Instrument: 2 years
 Probes: 1 year
 Accessories: 6 months
 CO measuring cell: 1 year
 Printer: 1 year (not including
 printing mechanism)

Description	Part no.
Instrument	
testo 315-1 safe CO level measuring instrument with Instruction manual and battery	0632.0315
testo 315-2 safe CO level measuring instrument with Instruction manual and battery	0632.0317
Probe	
Test cable with clips for ionisation current measurement	0554.0551
Clamp probe for quick measurement of flow and return temperature up to max. +100 °C, pipe diameter: max. 1y	0602.4692
Pipe clamp probe with velcro up to max. +120 °C	0628.0020
Accessories	
Testo printer , prints data with location, date and time	0554.0545
Spare rolls for printer	0554.0569
Rechargeable battery	0515.3120
Recharger for 9 V rechargeable battery	0554.0025
Recharger for printer	0554.0110
Pressure set with flue probe	0554.3150
TopSafe , indestructible protection case	0516.0443
Case	0516.0191
Service case	0516.3120
Spare parts	
Fine-wire fuse	0554.0406



testo AG

Postfach 11 40, 79849 Lenzkirch

Testo-Straße 1, 79853 Lenzkirch

Telefon: (07653) 681-0

Fax: (07653) 681-100

E-Mail: info@testo.de

Internet: <http://www.testo.com>