



testo 445 · testo 645

Instruction manual

en



Contents	2
Foreword	3
Initial operation	4
First measurement	5
Instrument description	
-Keypad/ connection assignment	6
-Display	7
Overview of controls	8-9
1. Current measurement	10
Switching on, selecting parameter in display	10
Saving, printing	10
2. Measurement functions 11-13	
Freezing readings	11
Maximum readings	11
Minimum readings	11
Multi-point mean calculation	12
Timed mean calculation	13
3. Location selection	14
4. Parameter settings	15-17
System adjustment (testo 645)	15
Adjusting humidity probes	16
Displaying calculated humidity parameters (td°C; g/m ³ ; g/kg; J/g)	16
Switches CO ₂ ppm → Vol% (testo 445)	16
Initialising differential pressure probe (testo 445)	17
Activating m/s in differential pressure probes (testo 445)	17
Activates volume flow and sets duct cross-sections for velocity and differential pressure probes (testo 445)	17
5. Memory settings	18-21
Overview	18
Manual saving	19
Automatic saving	19
Reading or printing memory contents	20
Clearing memory contents	21



According to the conformity certificate, the instruments fulfill **2004/108/EEC** guidelines.

© 1999 Copyright Testo GmbH & Co.

The software and software structure included in the product **testo 445/645** are protected by copyright laws worldwide.

6. Instrument configuration	.22-26
"AutoOFF" power save function	.22
Setting power supply, with rechargeable battery or battery	.23
Setting date/time	.24
Setting parameters for absolute pressure and density compensation	.25
Unit selection	.26
Factory reset	.26
7. Velocity measurement	.27-28
Volume flow funnel (testo 445)	.27
Pitot tube and pressure probe (testo 445)	.28
Thermal anemometer probes (testo 445)	.28
8. CO/CO ₂ measurement	.29-30
Measuring absolute pressure	.31-32
Error messages	.33
Technical data	.34-35
Ordering data	.36-43

Foreword

Dear Customer

You have made the right decision by choosing a measuring instrument from Testo. Every year, thousands of customers purchase our high-quality products. There are many good reasons for this.

- 1) We offer value for money. Reliable quality at the right price.
- 2) Considerably longer guarantee periods of up to 3 years - depending on the instrument.
- 3) With over 40 years of specialist experience we are optimally equipped to solve your measuring tasks.
- 4) Our high quality standards are confirmed by ISO 9001 certification.
- 5) It goes without saying that our instruments bear the CE mark required by the EU.

Please read prior to measurement



Do not measure on live parts.

Do not switch instrument on or off with the  button
- during instrument configuration
- during automatic saving

Complete automatic saving before connecting instrument to the Comfort software.

If the instrument does not function remove battery and put it in again. The respective error message is shown in the display. Refer to the information on “Error messages” on page 33 of the Instruction manual.

Observe storage and transport temperature and max. operating temperature (e.g. protect measuring instrument from direct sunlight)

When changing configurations (e.g. changing the probe), the instrument should be switched off because the values specific to the probe can only be read when the instrument is switched on. The V24 cable (PC connection) can be inserted anytime.

A simultaneous print command is not possible if the PC cable is connected.

Ensure that the contacts are correct in probes with a plug-in head.
The swivel nut in the probe handle should be securely tightened.

Opening the instrument, inexpert handling and use of force cancels your warranty.

Putting in the batteries

9V block battery is included in delivery.

Open the battery compartment at the back of the instrument.
Put in block battery. **Observe polarisation.**
Close battery compartment.

Refer to “Power supply” Chapter for more information on alternative power supply, charge, battery quality, charging procedure.



Observe instrument configuration when using rechargeable batteries.

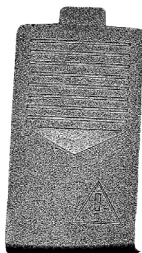
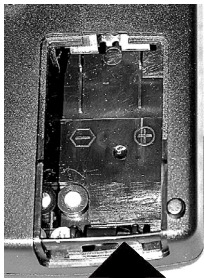

A description of the instrument and an overview of the controls guarantee a quick introduction.

Note: *The measuring instrument must be switched off before a probe is connected.*



Instrument configuration

You will receive up-to-date readings once a probe is inserted and the measuring instrument is switched on. However, you will still need to update or define the data in the instrument:

- ⇒ Date/Time:
- ⇒ Auto Off:
- ⇒ Units:

Some things can only be set via PC software (See Ordering data):

- ⇒ Location name (8 characters)
- ⇒ Log head (24 characters), e.g. your company name - is also printed when readings are printed.

Instrument description

Keypad/Connection assignment

Connection assignment:

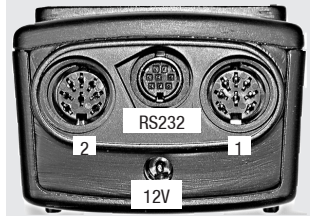

testo 445

Socket 1:

- Thermal velocity probes (heated wire or ball)
- Vanes (inductive)
- Temperature probes (Type K/J/S T/C or NTC)
- Differential pressure probes (piezoresistive)
- Absolute pressure probes (piezoresistive)
- CO₂ probe (2 beam infrared sensor)
- CO probe

Socket 2:

- Combined probe for humidity (capacitive) and temperature (NTC or Ni 10000)
- 3-function probe for humidity (capacitive), temperature (NTC) and velocity (ball)

RS232: PC connection

12V: Mains connection

testo 645

Socket 1:

- Temperature probes (T/C type K/J/S or NTC)

Socket 2:

- Combined probe for humidity (capacitive) and temperature (NTC or Ni 10000)
- Temperature probes (PT100)

RS232: Connection for PC

12V: Mains unit connection

Keypad:

On/Off

Prints

Confirms menu setting/
executes function

Saves

Return to current measurement/
location

Arrow buttons
move the cursor

Hold Max Min
Mean



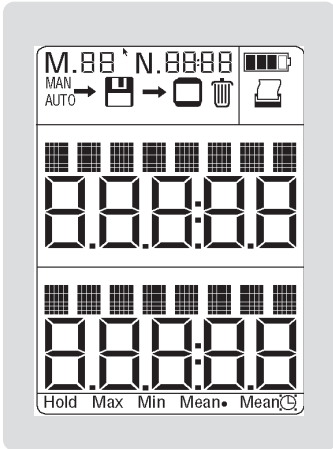

➔The symbols on the top line are explained below

➔Name of input socket and parameter

➔Displays reading in line 1

➔Name of input socket and parameter

➔Displays reading in line 2

➔Displays measurement functions

M. 00

N. 0000

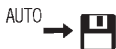

Explanation of symbols:

Counter for the log number in the memory.

When saving manually: number of a measurement saved.

When saving automatically: number of a measurement series.

This counter is needed in order to be able to find single logs or a measurement series when reading the memory.

Counter for saving a measurement cycle (is only required with automatic saving).

The measurement cycle in a measurement series can be found.

Manual saving of a single measurement by pressing the save button .

Automatic saving program has been set up.

Saving is activated by pressing the button.

Symbol for reading contents of memory on display.

Symbol for deleting memory contents

If this symbol appears, the printing function is activated.

The symbol flashes while data is being transmitted. You can print on the desktop printer by pressing the print button .

Shows capacity of battery and rechargeable battery.

If the inner segment no longer appears (symbol flashes), the battery has to be changed or the rechargeable battery has to be recharged. The instrument switches itself off automatically after 1 minute.

Overview of controls

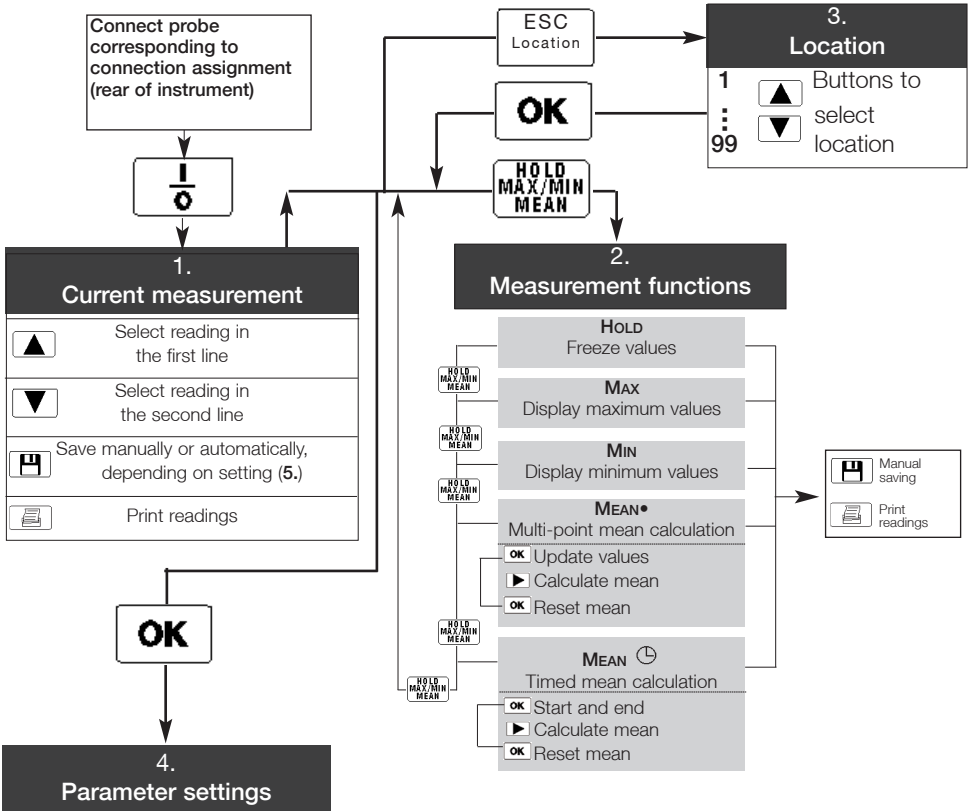

Selected parameter	The setting functions are activated in accordance with the reading selected - flashing cursor in display (See 1.):	testo 645	testo 445
°C (4.1)	System adjustment with EEPROM probe Reset - system adjustment	X	
% (4.2)	Humidity probe (0636.9740 and 0636.9715)/ Checks and adjusts 3-function probe (0635.1540)	X	X
td (4.3)	Select calculated humidity parameters: td°C dew point g/m ³ - absolute humidity, g/kg - degree of humidity, J/g - enthalpy	X	X
m/s, mbar m ³ /h (4.4)	Differential pressure probes: initialisation, activation/deactivation m/s, m ³ /h in addition to mbar Velocity probes: activation/deactivation m ³ /h in addition to m/s Change cross-section input for an activated volume flow measurement	X	X
ppm (4.5)	Switch between ppm and vol% with CO ₂ Initialisation of CO probe		X

Overview of controls

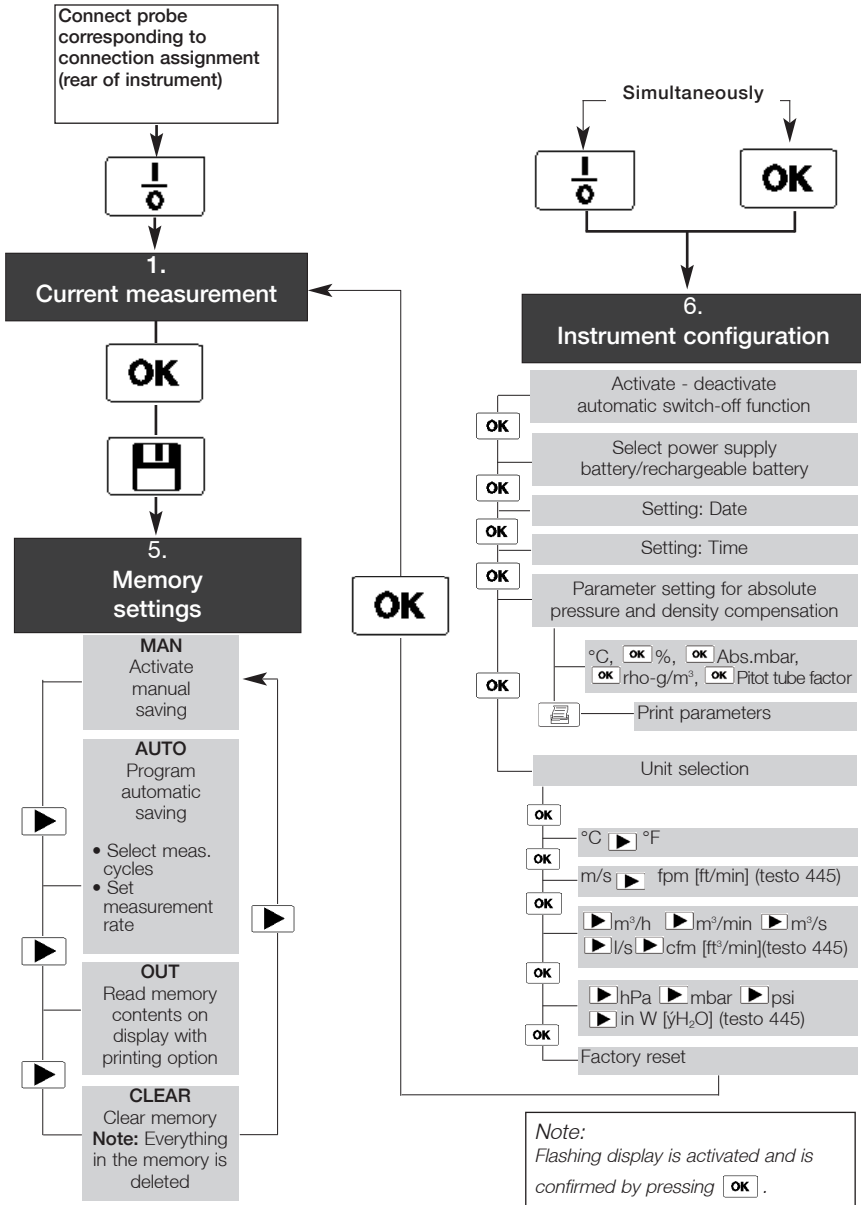

1. Current measurement

Switching on / Selecting parameters / Saving / Printing

Connect measurement probes

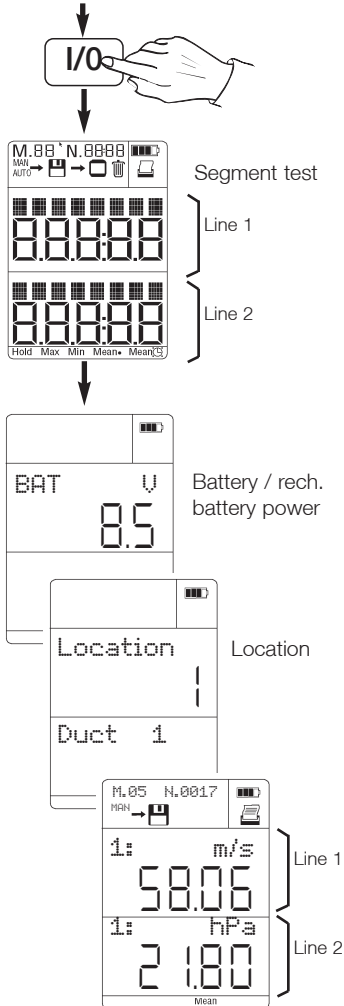

Current readings - different, depending on probe(s) connected.

All of the readings, made available by the probes connected to socket 1 and 2, on both lines of the reading display can be called up with the exception of the value selected in the other line.

Scroll with ▲ button in line 1:

- ① Select socket.
- ② Select parameter.
If this button in multi-function probes is pressed repeatedly, it is possible to select the parameter (°C, m/s...) to be displayed.

Scroll with ▼ button in line 2:



- ① Select socket.
- ② Select parameter.
If this button in multi-function probes is pressed repeatedly, it is possible to select the parameter (°C, m/s...) to be displayed.

There are different processing options available in the menus described below corresponding to the parameters selected.

Example of a reading:



It is possible to activate the following functions during measuring at the touch of a button.

-  **Save readings**
Manual or automatic saving is determined by the save setting (Chapter 5)
-  **Print readings.**

Note on printing:

A distance of 0.5 m should not be exceeded in order to guarantee problem-free data transfer. Objects between instrument and printer prevent the data from being transferred. Please observe notes in the instruction manual on the printer.

2. Measurement functions

Hold/Max/Min

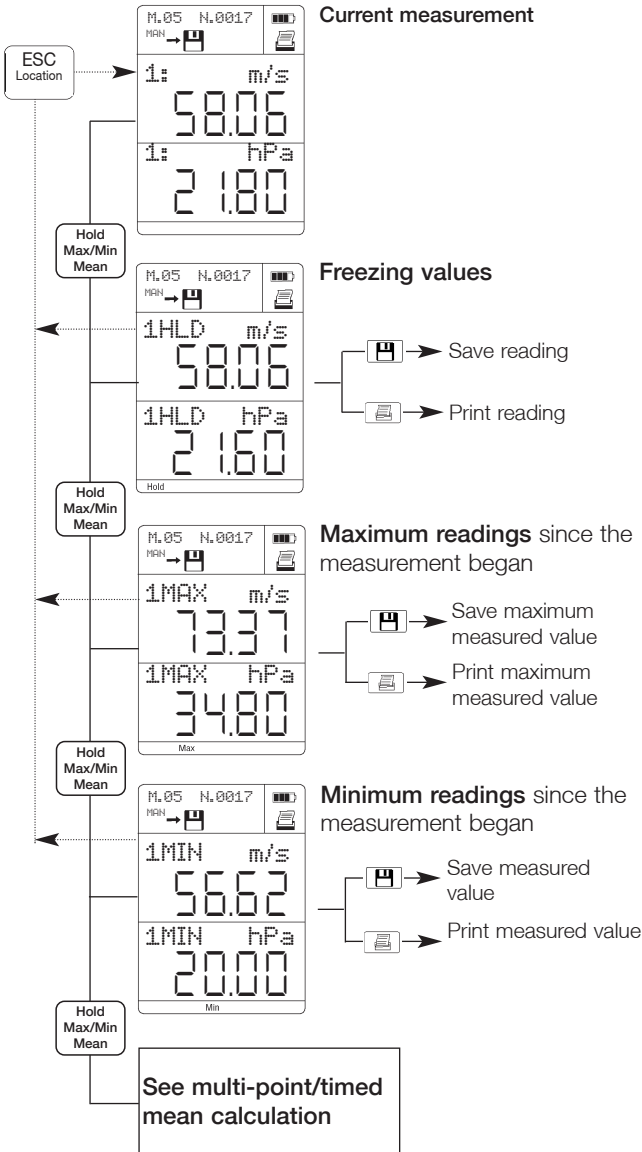

2. Measurement functions

Multi-point mean calculation **Mean•**
 Only for parameter in the 1st line

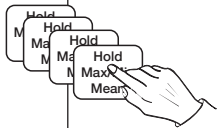
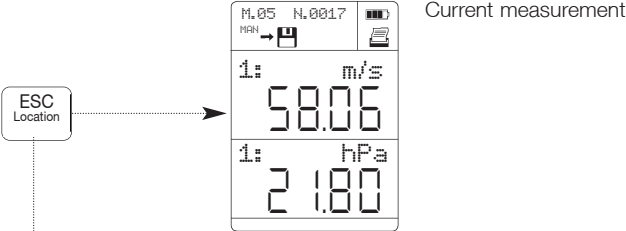

Multi-point mean calculation

The mean is only calculated for the parameter selected in the first line.

Exception:
 Selection of volume flow (see note on page 13)

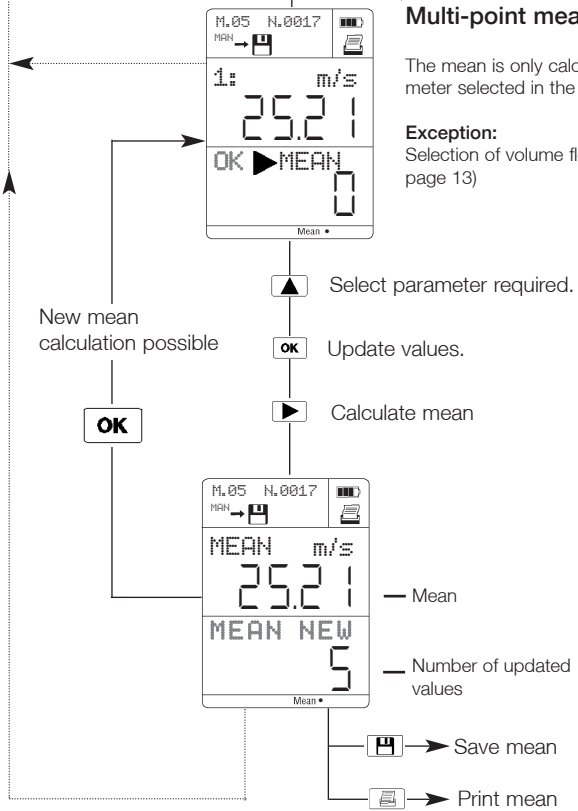

2. Measurement functions

Current measurement

Timed mean calculation **Mean**

Only for parameter in the 1st line

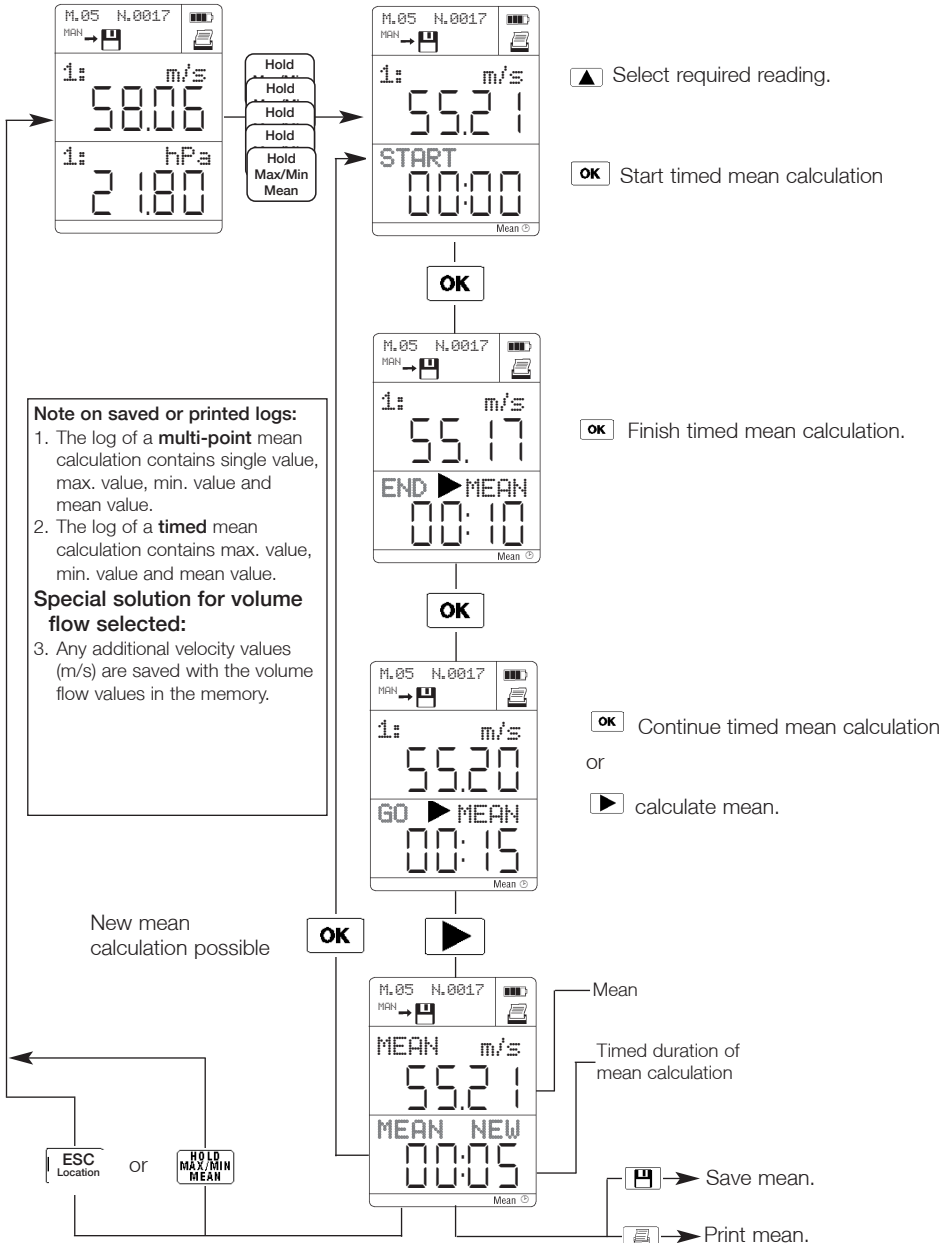

3. Location selection

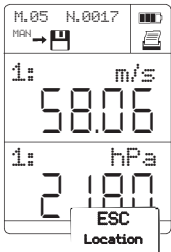

1. Current measurement

The location names Location 1 to 99 are specified by the factory.

Additional location names (8 characters) can only be loaded onto your instrument using PC software.

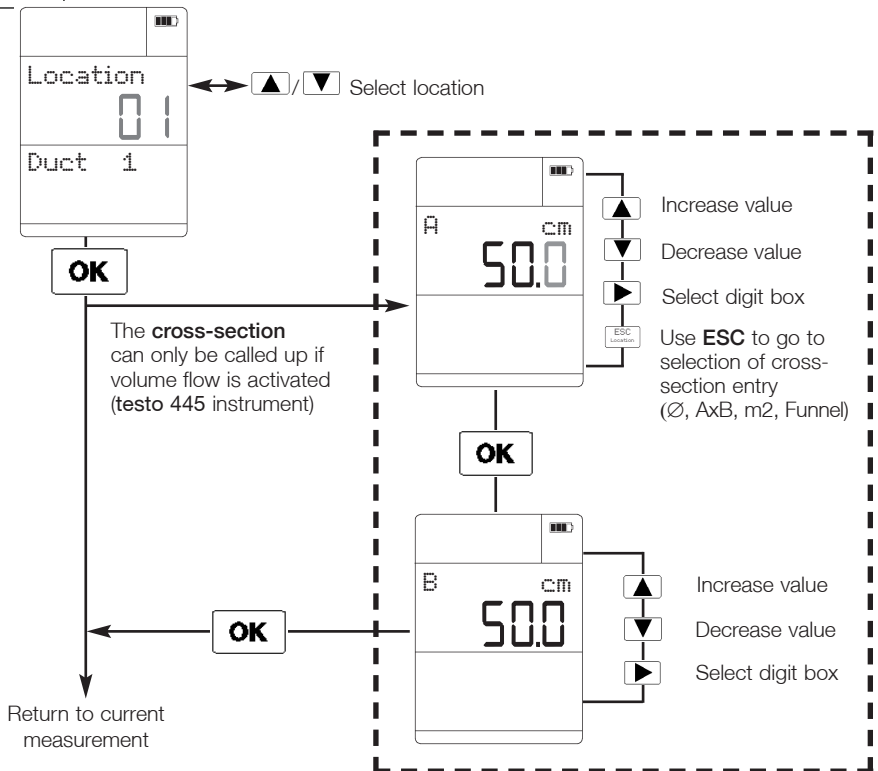

or :

From now on all measured data which is saved or printed is linked to the selected location or product names.

4. Parameter settings

System adjustment



The **setting functions** are activated in accordance with the reading selected - flashing cursor in display.

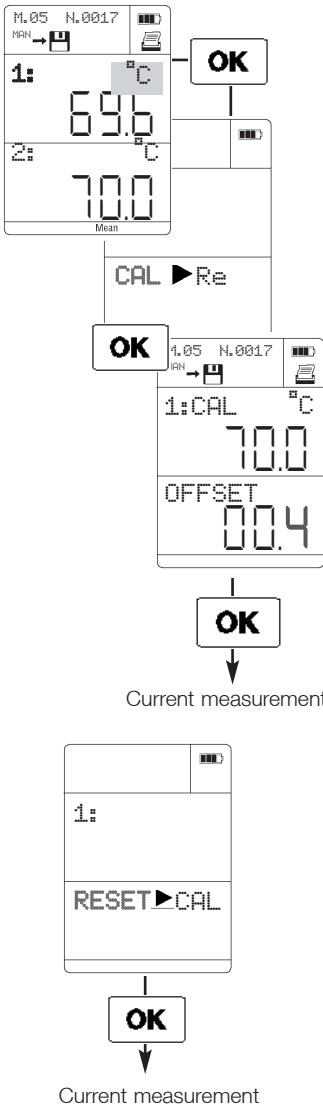

System adjustment (only possible in testo 645):

testo 645 and probes with EEPROM (Part no. 0614.xxxx) can be adjusted to the "zero error adjustment point". The probe characteristic saved in the measuring instrument is offset at a measurement point. This is simply entered in the instrument at the touch of a button. The following serves as a reference for offset calculations:

- A Testo calibration certificate or
- A highly accurate Pt100 probe:

An accurate Pt100 probe measures the temperature at socket 2; an inaccurate but quick probe measures in the same substance; the offset correction must be such that both probes show the same value.

Example: The reference probe in socket 2 measures 70.0 °C in the vat.

The probe in socket 1 measures 69.6 °C.

Correct by 0.4 °C!

The respective flashing position can be changed using the **▶** **▲** **▼** buttons or confirmed by pressing **OK**.

Note:

Offset is saved in probes with EEPROM and is automatically recognised when the instrument is switched on.

In probes without EEPROM, the set offset is located in the input socket.

The OFFSET value is displayed or printed when switching on, saving or printing.

Deleting system adjustment: The set OFFSET is reset to 00.0.

4. Parameter settings

Adjusting: humidity probes / humidity parameters / ppm → vol%

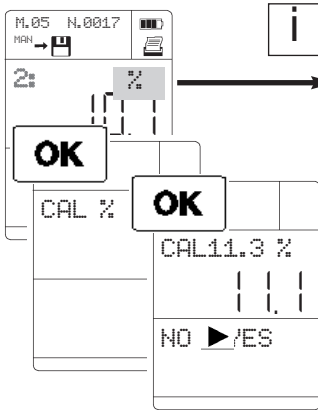

The **setting functions** are activated in accordance with reading selected - flashing cursor in display.

Adjusting humidity probes
Monitoring and adjusting humidity probes
 (0636.9740/0636.9715) or 3-function probe (0635.1540).



To carry out the adjustment, immerse the probe in the adjustment container belonging to the control and adjustment set (Part no. 0554.0660). Observe the instructions given in the Instruction manual (0973.1820)!

NO flashes → **OK** → No adjustment.

YES flashes → **OK** → The probe is adjusted.

▶ → Switch to YES/NO

OK → Confirm selection and return to measurement.

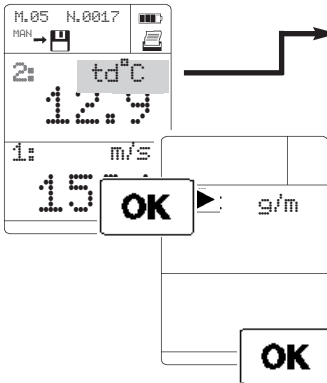

Displaying calculated humidity parameters.

If Testo's combination humidity probe (e.g. 0636.9740) is connected, **testo 445** and **testo 645** display a calculated humidity parameter in addition to temperature and relative humidity. You can select from the following parameters:

td°C ▶ g/m³ ▶ g/kg ▶ J/g ▶ td°C ...
 Dew point Absolute Degree Enthalpy
 temperature humidity of humidity

Degree of humidity and enthalpy are pressure-dependent parameters. Absolute pressure has to be set (See 6. Instrument configuration -Parameter setting).

The respective selected parameter flashes.

▶ → Select

OK → Confirm selection and return to measurement..
 The selected humidity parameter is displayed.

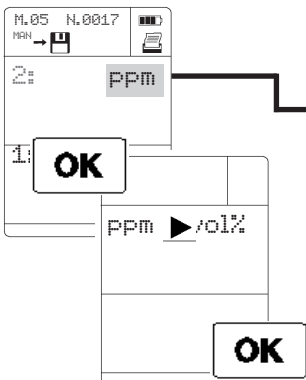

Switch between ppm and vol% if a CO₂ probe is connected
 (only possible in a testo 445 instrument).

PPM ▶ vol% ▶ ppm ...

The respective selected parameter flashes.

▶ → Select

OK → Confirm selection and return to measurement.

4. Parameter settings

Initializing pressure probe / Activating velocity and volume flow

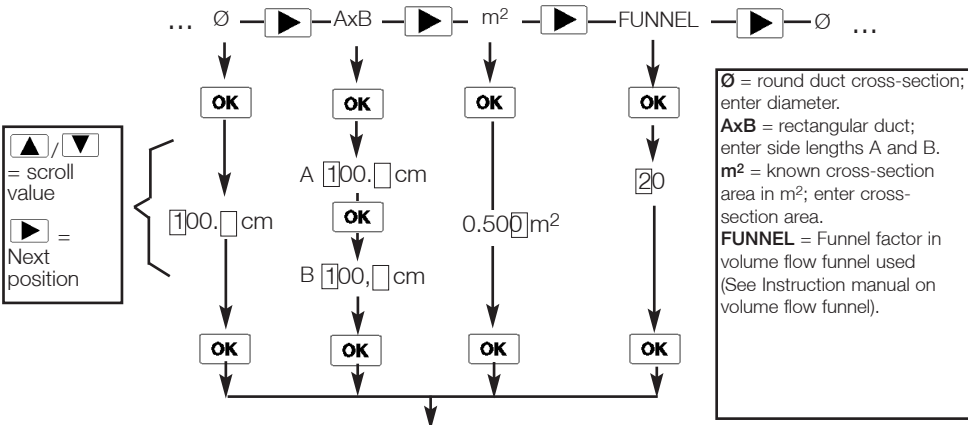
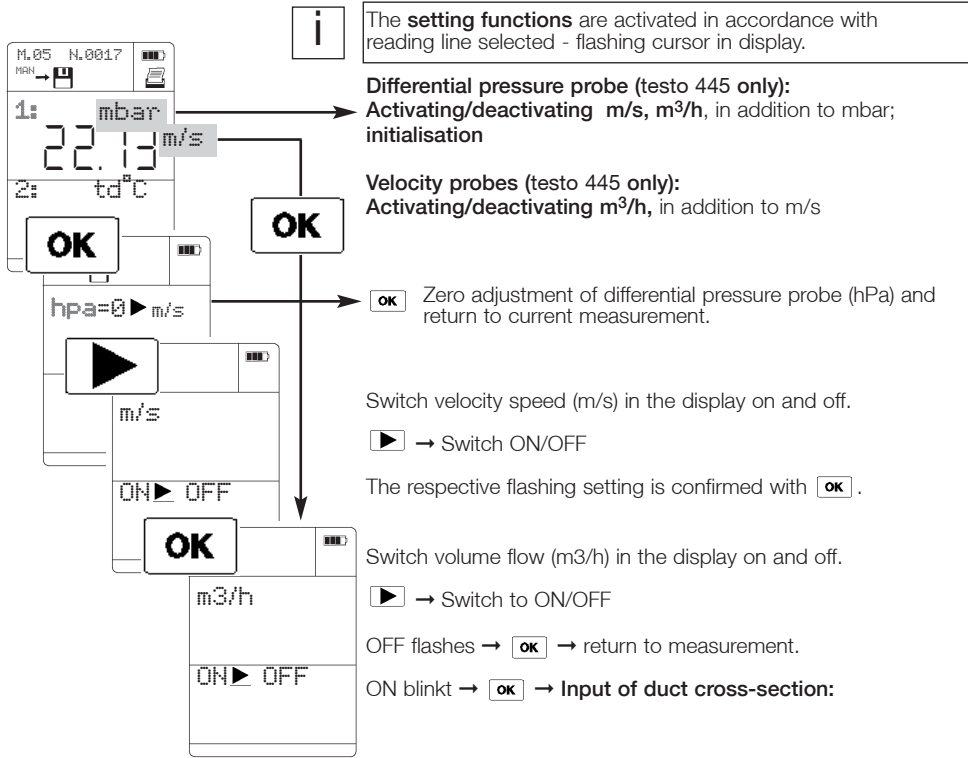

Once the cross-section is entered, return to the current volume flow measurement.

5. Memory settings

Overview



Press the **OK** button to get to the memory settings mode.
Confirm flashing save symbol via button.

1. Current measurement

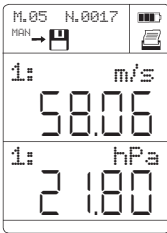

4 memory settings are possible. Select the required saving option by pressing :

MAN AUTO OUT CLEAR MAN ...

The symbol corresponding to the selection appears in the top line.
The function is activated with **OK**.

ESC
Location



Parameter settings
(See Chapter 4).

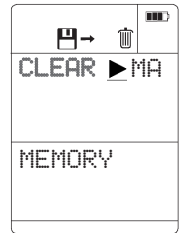
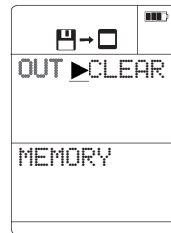
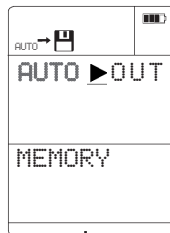
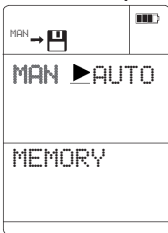

ESC
Location



①



②



③



④

5. Memory settings

Manual / Automatic saving

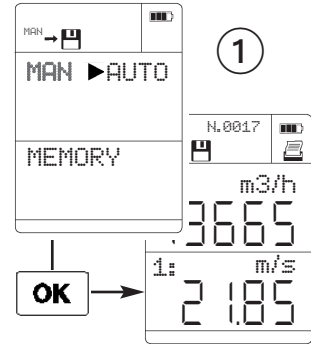

MAN

Manual saving:

Each time is pressed a log of the measurement is saved in the instrument and includes measured values, location, date and time. The counter in the top left corner of the display shows the number of logs saved for this location.

Saving a log with timed or multi-point mean calculation :

The log includes MIN value, MAX value and mean of the measurement and also single values in multi-point mean calculations.

AUTO

Automatic saving:

When this saving function is set, the instrument automatically accepts the measured values at fixed intervals and saves them (=logger operation).

The number of measuring cycles (CYCLE-N.) to be saved and intervals (CYCLE) have to be programmed:

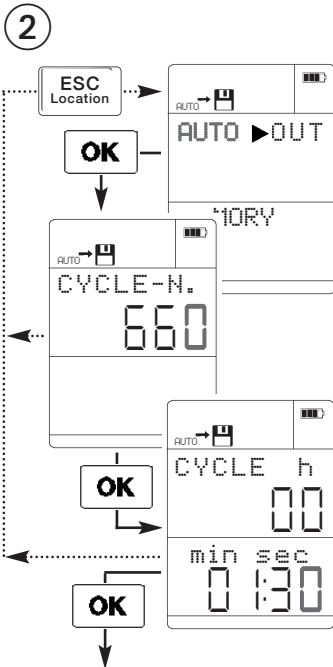

1. Cycle-N.

The instrument automatically offers the maximum possible number of measuring cycles. Set required number using

/ / .

Confirm set value by pressing .

2. Cycle

Select interval in which the measured values are to be saved. The blinking position can be changed using .

Confirm set value by pressing .

Automatic saving is started by pressing . The symbol flashes until the programmed measurement series is accepted.

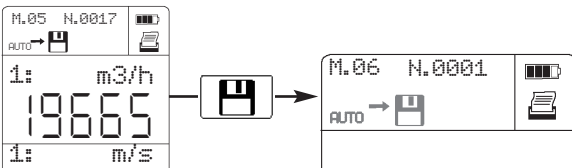





Cancel saving procedure.

Starts automatic saving again. An additional measurement series is added.

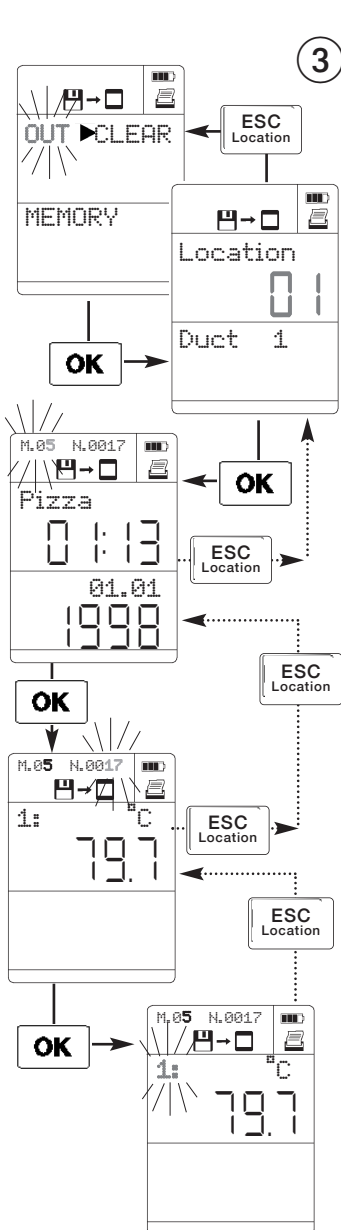
5. Memory settings



Reading or printing memory contents





Press the **OK** button to access the memory settings mode. Confirm flashing save symbol  via the  button. Cancel printing by pressing the  button.



OUT

1. Reading out or printing memory contents:

If the "OUT" display is flashing and the  button is pressed, printing of the complete memory contents is started. Cancel printout by pressing the  button.



2. Selecting the location:

If **OK** is activated selection options appear in the display to select the required location. Select location by pressing  .

If printing is activated by pressing  at this point, **all** of the logs (measurement series and cycles) for this location are printed. Cancel printout by pressing the  button.

3. Selecting the log:

Confirm the location selected above by pressing **OK**. The M.0x counter flashes in the display.

Select the log no. by pressing  .

 activates a printout of the selected measurement log.

Press **OK** to display the values measured.

Cancel printout by pressing the  button

4. Selecting the measurement cycle: (only possible if a measurement log consists of a measurement series):

Confirm the measurement log selected above by pressing **OK**. The N.0x counter flashes in the display.



Select the measurement cycle by pressing  .

 activates a printout of the selected measurement cycle.

The  button enables you to go back one step.

5. Memory settings

Clearing memory contents/Sample printouts

i Press the **OK** button to access the memory settings mode. Confirm flashing save symbol  via the  button.

4 CLEAR Clearing memory:

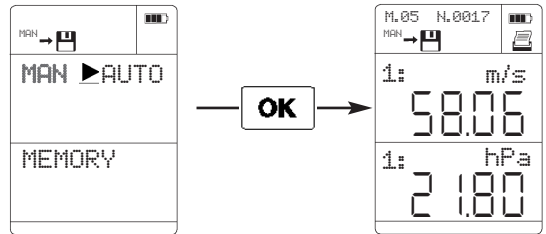
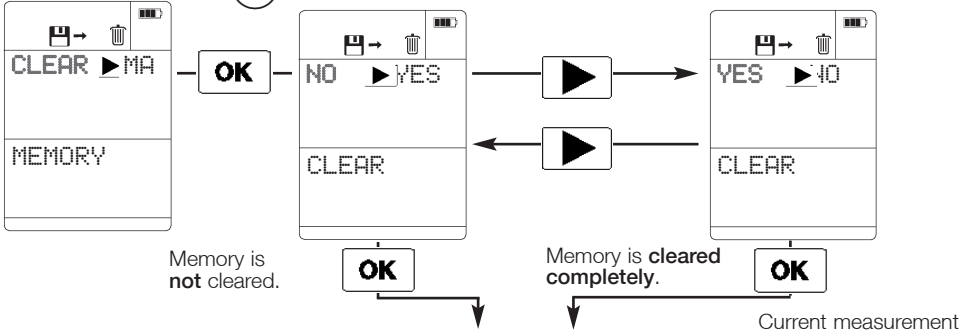

Printout of automatic saving procedure:

```

Header ----- Firma Mustermann
Date of printout ----- 31.08.1998 11:27:32
Location ----- Raum 1

Log ----- M.002
Start of saving ----- 31.08.1998 11:26:59

Save ----- cycle: 00:0002

-----
Readings -----
                1:°C      2:%      2:°C
01      21.4      45.1      22.2
02      21.2      44.7      22.3
03      21.1      44.6      22.3
04      21.8      44.6      22.3

                2:m/s      2:td°C
-----
01      1.00      9.8
02      1.66      9.7
03      2.01      9.7
04      1.52      9.7

Info :
    
```

Printout of manual saving:

```

Messrs. Smith
31.08.1998
11:26:05
Raum 1

M.001
31.08.1998
11:20:05

1: 21.4      °C
2: 44.7      %
2: 22.1      °C
2: 0.55      m/s
2: 9.6       td°C

Info :
    
```



6. Instrument configuration

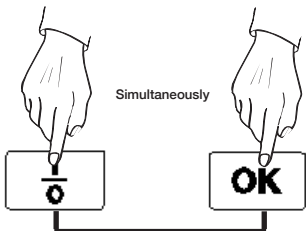

Power save function / Power supply

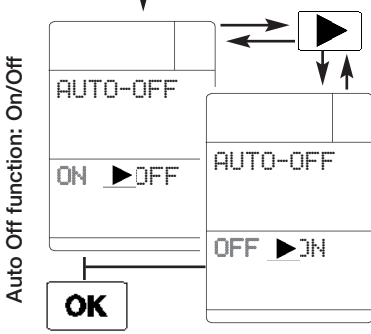

The  button enables you to change to the current measurement from every menu item.



The  button has to be kept pressed for approx. 2 seconds when switching on the instrument ( button).

The blinking position can be changed by pressing   or confirmed by pressing .

Power save function
Auto OFF function is switched on (“ON”)

If a button has not been pressed in the last 5 minutes or there is no communication with the PC, the instrument switches off automatically.

Exceptions:

- the instrument does not switch off if the mains unit is plugged in
- the function is deactivated during timed and multi-point mean calculation

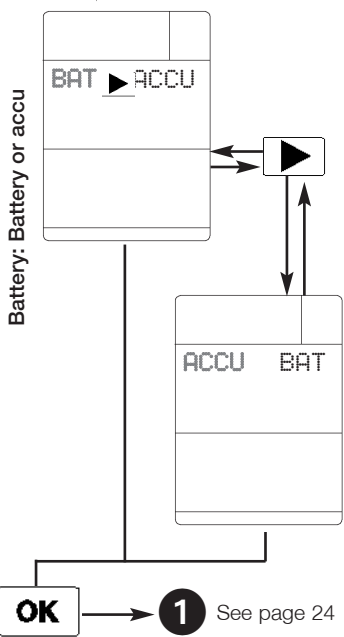

Important:
The instrument must be set at battery or rechargeable battery operation.
 Incorrect instrument setting
 - Rechargeable battery operation is set and battery is put in:
 If the mains unit is connected and the charging procedure is confirmed:
 ⇨ **Risk of explosion!!!!**
 - Battery operation is set and rechargeable battery is put in:
 Rechargeable battery will **not** be charged.

6. Instrument configuration

Power supply

Battery operation with 9 V block battery, alkali manganese IEC 6LR61.

Parallel power supply is possible with mains unit without damaging batteries.

Zinc carbon batteries should not be used with thermal probes because their inner resistance is too high and the probe is not supplied with sufficient energy. The instrument switches off.

Rechargeable battery operation with Testo rechargeable battery (Part no. 0515.0025), Type: Ni-MH IEC 6F22.

If the **rechargeable battery is empty**: Parallel power supply and simultaneous recharging of the battery in the instrument with mains unit.

Connect mains unit to **recharge battery**. Query as to whether rechargeable battery should be recharged.

Has a rechargeable battery or battery been put in? **Check!**

There is a risk of explosion if batteries have been put in! Select "NO" in this case.

If a rechargeable battery is inside confirm Charge "Yes" with

The instrument can be switched off if a measurement is not taking place. The rechargeable battery capacity and power is displayed.

Recharging takes approximately 6 hours if the rechargeable battery is completely empty.

Correct battery recharging in the instrument via the mains unit can only be guaranteed if the above mentioned Testo rechargeable batteries are used. If other rechargeable battery types are used, recharging will have to be carried out by an external recharger.

Note:

The instrument should be switched off before changing the battery/rechargeable battery or when operating using mains unit without rechargeable battery and battery. If the battery/rechargeable battery is removed, the instrument loses the set values (date/time). The capacity of the battery/rechargeable battery is shown in the display:



100 %



75 %



50 %



25 % (if the last segment is flashing the battery/rechargeable battery is almost empty)



0 % (change battery/recharge rechargeable

Operation via mains

unit (Part no. 0554.0088):

Insert mains unit in the mains unit socket of the instrument (see connection assignment).

6. Instrument configuration

Setting date/time



The  button enables you to change to the current measurement from every menu item.

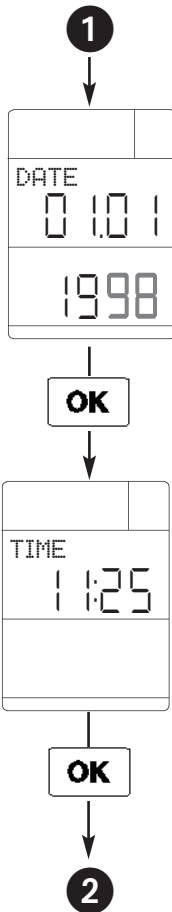

Setting date

The flashing position in the display can be set

-  /  = scroll/  = next position -

Setting the time

The blinking position in the display can be set

-  /  = scroll/  = next position -

6. Instrument configuration

Parameters

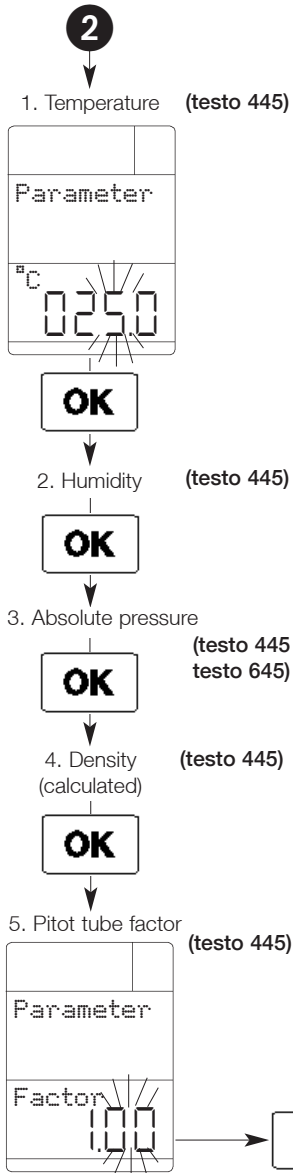

Parameter setting for pressure and density compensation:

Humidity (g/kg, J/g), velocity (measured with thermal probes) and CO_2 are pressure-dependent parameters.

Density is included in the measurement when velocity is measured using a Pitot tube.

testo 445/645 automatically carries out pressure and density compensation. Temperature, humidity and absolute pressure must be entered.

3 parameters can be measured on location using a Testo humidity/temperature probe (e.g. Part no. 0636.9740) and the Testo absolute pressure probe (Part no. 0638.1645). See the Chapter "Measuring absolute pressure" for more information on measuring absolute pressure without an absolute pressure probe.

Density is automatically calculated by the instrument based on these 3 values:

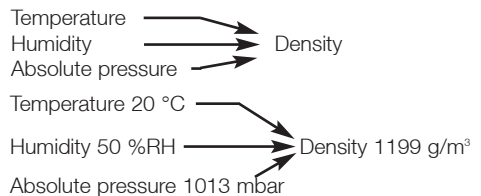

Note:

If the density set in the factory is taken as the basis, the measurement error can be up to 10% of the measurement when velocity is measured using a Pitot tube. Parameters must be determined and set in the instrument in order to achieve exact measurements.

The flashing position in the display can be set.

- / = Scroll/ = Next position -

= Confirm.

= Print parameter.

Pitot tube factor setting:

The factor for Pitot tubes from Testo is constantly at 1.00 and does not need to be changed. If the Pitot tubes from other firms are used, ask your supplier for the Pitot tube factor and save in instrument.

6. Instrument configuration

Unit selection / Factory reset

3

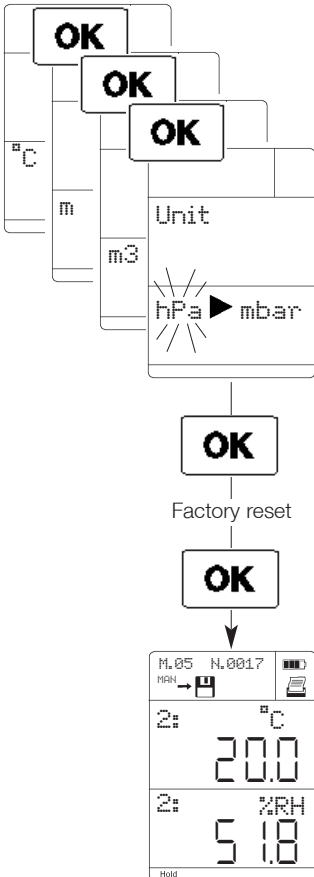



The  button enables you to change to the current measurement from every menu item.

°C  °F

The selected parameter flashes.

 → Select



 confirms the selection.

m/s  fpm (ft/min) (testo 445 only)

The selected parameter flashes.

 → Select

 confirms the selection.

m³/h  m³/m (m³/min)  m³/s 

l/s  cfm (ft³/min) (testo 445 only)

The selected parameter flashes.

 → Select

 confirms the selection.

hPa  mbar  psi  in W (°H₂O) (testo 445 only)

The selected parameter flashes

 → Select

 confirms the selection.

Factory reset

Factory reset (confirm with "Yes") resets all of the settings in the instrument configuration to the factory settings.

 confirms the selection and switches to the display of the current setting.

Current measurement





7. Velocity measurement

Volume flow funnel (testo 445)

A volume flow funnel is needed to measure the volume flow in a ventilation opening (grid or outlet with dual wall clearance). The opening of the funnel must be covered completely by the grid (max. 190 x 190 mm with 0554.0400 or max. 350 x 350 mm with 0554.0410).

For the measurement, a velocity probe (0635.1041, 0628.0005 or 0635.9540) is placed in the funnel's hole, is positioned in the middle and is aligned. The probe is snapped into the funnel's handle. Connect the probe to the instrument and switch on.

Position the cursor on the m/s parameter ( or ).

You will get to the "Parameter setting" menu by pressing  .
Press  to get the volume flow (m³/h) in the display. Confirm the m³/h ON setting by pressing  .
Press  twice and confirm with  (funnel/=funnel factor).

Enter the factor for the funnel used by you:

Funnel factor for funnel with part no. 0554.0400 = 20

Funnel factor for funnel with part no. 0554.0410 = 22

Press the funnel tightly on the opening. You can accept the displayed reading as it is or you can carry out a timed mean calculation if the readings fluctuate.

7. Velocity measurement

Pitot tube and pressure probe (testo 445)



The measuring range is not symmetrical when the measurement is carried out using differential pressure probes (see Technical data on page 35)

Connect silicone hose to the correct connection plug (observe + and - on the probes.)

When measuring velocity with the Pitot tube, it is better to use the 0638.1445 pressure probe on account of its optimum accuracy. The measuring range extends to approx. 40 m/s. Velocity v is calculated in the instrument using the pressure difference Δp in the Pitot tube and based on the following formula:

$$v \text{ [m/s]} = S \times \sqrt{\frac{200000 \times \Delta p \text{ [hPa]}}{\rho \text{ [g/m}^3\text{]}}}$$

Press **OK** to activate the conversion. The “Parameter setting” menu is displayed. m/s appears in the display when activated via the **▶** button. Confirm the m/s ON setting with **OK**. The next step is to decide, using the **▶** button, as to whether the volume flow is to be calculated immediately (m³/h ON) or not (m³/h OFF). Confirm input with **OK**.

Pitot tube factor S and the temperature, humidity and absolute pressure parameters required to automatically calculate density have to be set in the instrument configuration.

The Pitot tube factor for testo Pitot tubes is at a constant 1.00 and does not need to be changed. If non-Testo Pitot tubes are used, please ask your supplier for the factor and save it.

Thermal anemometer probes (testo 445)

The measuring principle of thermal anemometers with a heated wire or heated ball sensor is based on the cooling down of the sensor element via the air flow. The sensor element is heated to 100 °C for this purpose. The power needed to keep the sensor constantly at this temperature is a measure of the strength of the flow. According to this measuring principle, this probe requires a heating up period after being switched on which appears as “Count Down” in the display. Measuring in accordance with this measuring principle depends on the ambient pressure. The absolute pressure can be set in the instrument configuration menu.

CO/CO₂ measurement (testo 445)

CO measurement (testo 445)

The connected probe 0632.1247 is initialised during the switch-on phase ("Count Down" runs in the display). For this reason, the measuring instrument should only be switched on in an atmosphere free of CO. Values will be too low otherwise in subsequent measurements.

If you want to initialize the instrument while switched on, place the probe in an atmosphere free of CO. Press and confirm initialisation of the CO probe (CO=0) by pressing again.



Connect probe before switching on the instrument

The protective cap must be on the probe during the initialisation phase (otherwise risk of inaccurate measurements).

The initialisation cap should only be removed during the actual measurement and should be replaced directly afterwards (mechanical protection of sensor and adherence to accuracies).

Cigarette smoke influences the measurement (min. 50 ppm).

A smoker's breath influences the measurement by approx. 5 ppm.

Switch on - Initialisation phase (60 s).

The ambient CO probe is initialised during the initialisation phase.

- Remove yellow protective cap.
- Probe can be put in shirt pocket, for example. The direction of the flow on the probe influences the accuracy of the measurement. Optimum measured results are achieved by moving the probe gently back and forth. If the air blows head-on on the sensor, the values measured will be too high.

CO₂ measurement

CO₂ measurement (testo 445)

The 0632.1240 probe measures concentrations from 0 to 1 vol % CO₂. The unit can be switched between ppm and vol% as described in "Parameter settings" on page 16.

The measuring principle is based on infrared absorption. The probe has a relatively high power consumption on account of its sensor. Use mains unit and rechargeable batteries for long-term measurements.

**Note: The correct reading is available 20 to 30 seconds after being switched on.
The corresponding "Count Down" is displayed.**

If there are major changes in the concentration, the probe needs 30 - 60 seconds to adapt itself to the outside world. Gently swinging of the probe shortens the adaptation time.



Hold the probe as far away as possible from you to reduce the influence of the CO₂ level in your breath on the measurement.

Pressure offset

Please note that the CO₂ reading depends on absolute air pressure. This effect is compensated in the instrument. Enter the correct absolute pressure for the location in the "Instrument configuration" menu (see Chapter 6).

Permissible ambient temperature: 0 to +50 °C
Permissible storage temperature: -20 to +70 °C

Measuring absolute pressure

Absolute pressure is calculated from:

- **Elevation pressure (metres above NN)**

The annual mean is 1013 mbar at sea level, the higher the location above sea level, the lower the pressure.

- **Barometric pressure**

The annual mean is 1013 mbar regardless of height. This pressure can deviate from the annual mean by ± 20 mbar depending on the weather (see display on nearest barometer).

- **Differential pressure**

is the positive or negative pressure in the duct.

You can determine the annual mean air pressure value for your elevation using the following table and any additional fluctuation using a barometer or ask your weather station for the exact air pressure value.

Elevation M.S.L	Air pressure (mbar)	ElevationM .S.L	Air pressure (mbar)	ElevationM .S.L	Air pressure (mbar)	ElevationM .S.L	Air pressure (mbar)
0	1013	1250	871	2500	746	3750	636
50	1007	1300	866	2550	742	3800	632
100	1001	1350	861	2600	737	3850	628
150	995	1400	855	2650	732	3900	624
200	989	1450	850	2700	728	3950	620
250	983	1500	845	2750	723	4000	616
300	977	1550	840	2800	719	4050	612
350	971	1600	835	2850	714	4100	608
400	966	1650	830	2900	709	4150	604
450	960	1700	824	2950	705	4200	600
500	954	1750	819	3000	700	4250	596
550	948	1800	814	3050	696	4300	592
600	943	1850	809	3100	692	4350	588
650	937	1900	804	3150	687	4400	584
700	931	1950	799	3200	683	4450	580
750	926	2000	794	3250	678	4500	577
800	920	2050	789	3300	674	4550	573
850	915	2100	785	3350	670	4600	569
900	909	2150	780	3400	666	4650	565
950	904	2200	775	3450	661	4700	562
1000	898	2250	770	3500	657	4750	558
1050	893	2300	765	3550	653	4800	554
1100	887	2350	760	3600	649	4850	550
1150	882	2400	756	3650	644	4900	547
1200	877	2450	751	3700	640	4950	543
						5000	540

Table: Barometric elevation formula

Determining absolute pressure

Example:

If you are at 800 m above mean sea level, you have an annual mean air pressure of 920 mbar.

The annual mean air pressure has to be reduced by 10 (910 mbar air pressure) to correspond to the barometer display (1003 mbar) and to the barometer's height offset (to 1013 hPa).

Add the difference between your ambient air pressure and the static process air pressure (e.g. positive pressure in an air duct which is to be measured - can be measured using the differential pressure probe at up to 100 mbar) to this (air) pressure value.

Example: We have measured an annual mean air pressure of 910 mbar. We will now add 90 mbar based on the static process pressure. We therefore assume an absolute air pressure in the measurement medium of 1000 mbar.

The table on page 31 is also saved in the Testo Comfort software. Absolute pressure can be calculated automatically using this software if the height above mean sea level, barometric pressure and differential pressure are entered. The calculated absolute pressure is then taken over by the instrument.

Error messages

Error message	Cause	Remedy
Memory full	The memory is full	Clear memory
— — — — —	Measuring range has not been reached	The probe is not suitable for this measurement task. The measured values are outside the allowed measuring range. Remove probe from location.
— — — — —	Measuring range has been exceeded	The probe is not suitable for this measurement task. The measured values are outside the allowed measuring range. Remove probe from location.
— — — — —	<p>1st possibility Measuring range has been exceeded or has not been reached range. Remove probe from</p> <p>2nd possibility Probe is not connected or is defect</p>	<p>Some probes cannot differentiate between not reaching or not exceeding a measuring measurement location. The probe is not suitable for this measuring task. The measured values are outside the measuring range allowed.</p> <p>Check if the probe is connected to the right socket and that the plug has been pushed in far enough. Turn instrument on and off again If the error message returns, please contact your nearest Testo service point.</p>

If we were unable to answer your question, please contact your distributor or Testo Customer Service. For contact data, see back of this document or web page www.testo.com/service-contact

testo 645/445

General technical data

Memory space:	Up to 3000 readings
Power supply:	Battery / rechargeable batt.
Alternative:	12 V mains unit Battery recharging in instr.
Typical battery lifetimes:	Temperature/humidity probes, pressure probes, vane probes: 30 to 45 h Thermal probes, CO2 probes, 3-function probe: >3 - 12 h Reduce the hour times by a factor of 5 if a 9V battery is used.
Operating temperature:	0 to +50 °C
Storage temperature:	-20 to +70 °C
Weight:	Approx. 255 g incl. batteries
Other features	- Automatic recognition of all connected probes - RS232 interface for data management (electrically isolated)

Temperature measurement

Type K (NiCr-Ni)	
Measuring range:	-200 to +1370 °C
Accuracy* at 22 °C:	±0.3 °C or ±0.5 % of reading (the larger value applies)
Additional error over operating temperature range:	±0.2 °C
Resolution:	0.1 °C

Type J (FeCu-Ni)

Measuring range: -200 to +1000 °C

Accuracy* at 22 °C: ±0.3 °C or ±0.5 % of reading
(the larger value applies)

Additional error over operating temperature range: ±0.2 °C

Resolution: 0.1 °C

The following can also be connected:
thermocouple: Type S (Pt Rh-Pt)

NTC

Measuring range: -50 to +150 °C

Accuracy*: ±0.2 °C (-25 to +74.9 °C)
±0.4 °C (-50 to -25.1 °C/
+75 to +99.9 °C)
±0.5 % of reading
(+100 to +150 °C)

Resolution: 0.1 °C

Humidity measurement

Temperature: -20 to +180 °C

Measuring range: 0 to 100 %RH

Resolution: 0.1 %RH

System accuracy*: Up to 1.0 %RH
(see probe data)

Calc. humidity parameters: td, g/m³, g/kg, J/g
(pressure-compensated)

testo 645

Temperature measurement

Pt100

measuring range: -200 to +800 °C

Accuracy* ±0.2 °C or ±0.1 % of
at 22 °C: reading
 (the larger value applies)

Additional error
over operating
temperature range: ±0.1 °C

Resolution: 0.1 °C

testo 445

Velocity measurement

Vane

Measuring range: 0 to 60 m/s

Resolution: 0.01 m/s

Accuracy: See probe data

Thermal anemometer

Measuring range: 0 to 20 m/s

Resolution: 0.01 m/s (0 to 10 m/s)
 0.1 m/s (remaining range)

Accuracy: See probe data

Pitot tube

Measuring range: 0 to 10 mbar / 0 to 100 mbar
 0 to 40 m/s / 0 to 100 m/s

Resolution: 0.01 m/s

Accuracy: See probe data

Volume flow in m³/h, m³/min, l/s,
cfm (ft³/min)

Measuring range: 99,999 m³/h

Pressure measurement

Measuring range:	Resolution:	Accuracy*:
-40 mbar to 100 mbar	0.01 mbar	±0.1 mbar (0 to 20 mbar) 1 % of reading (rem. range)
-4 mbar to 10 mbar	0.001 mbar	±0.01 mbar
2000 mbar	1 mbar	±2 mbar

Pressure units can be switched:
mbar, psi; in W("H₂O)

Calculated velocity values
density compensated: 0 to 100 m/s

Calculated volume flow values:
m³/h, m³/min, l/s, cfm (ft³/min)

CO₂ measurement

Measuring range: 0 to 10000 ppm
 0 to 1 vol. %

Resolution: 1 ppm
 0.0001 vol. %

Accuracy*: ±50 ppm ±2 % of reading
 (0 to 5000 ppm)
 ±100 ppm ±3 % of reading
 (remaining range)

CO measurement

Measuring range: 0 to 500 ppm

Resolution: 1 ppm

Accuracy*: ±5 ppm (0 to 100 ppm)
 ±5 % of measured value
 (remaining range)

Warranty

Instruments	2 years
Probes	1 year

* Accuracy: ±1 digit

Ordering data

Measuring instruments/Accessories

Measuring instruments	Part no.
testo 645 humidity measuring instrument, with TopSafe 2 channel temperature (type K/J/S, NTC, Pt100 thermocouples) and humidity measuring instrument, with battery and calibration protocol	0563.6450
testo 445 multi-function measuring instrument, with TopSafe 2 channel multi-function measuring instrument for temperature (type K/J/S thermocouples), humidity, velocity, pressure, CO ₂ , CO with battery and calibration protocol	0563.4450
testo 645 humidity measuring instrument, without TopSafe 2 channel professional temperature (type K/J/S, NTC, Pt100 thermocouples) and humidity measuring instrument, with battery and calibration protocol	0560.6450
testo 445 multi-function measuring instrument incl. TopSafe 2 channel professional multi-function measuring instrument for temperature (type K/J/S thermocouples), humidity, velocity, pressure, CO ₂ , CO with battery and calibration protocol	0560.4450
Accessories	
Software	
Comfort software "Light" for data management, incl. data base, analysis and graphics function	0554.0273
Comfort software "Professional" for data management, incl. data base, convenient analysis and graphics function	0554.0274
RS232 cable to connect measuring instrument ↔ PC for the transfer of data	0409.0178
Printer	
Testo log printer with 4 AA batteries and 1 roll of thermal paper ; data is printed with location, product names, date and time	0554.0545
Printer paper for desktop printer (6 rolls)	0554.0569
Recharger with 4 standard rechargeable batteries for Testo log printer , batteries are recharged externally	0554.0110
Additional accessories	
Plug-in mains unit for mains operation and to recharge rechargeable batteries in the instrument	0554.0088
9 V rechargeable battery for testo 445, testo 645 measuring instruments	0515.0025
TopSafe / Cases	
TopSafe protects instrument from dirt, water (IP 65) and impact – dishwasher-proof – with bench stand, belt clips and probe clips to attach probe to TopSafe	0516.0440
Instrument case, plastic for instrument/printer and 2 probes in the case of testo 645	0516.3250
System case, plastic for instrument, probes and additional accessories Clear layout of case contents by placing probes in lid.	0516.0400
System case, aluminium for instrument, probes and additional accessories Clear layout of case contents by placing probes in lid.	0516.0410

Ordering data

Temperature probe for testo 645 / 445

NiCr–Ni surface probes	Meas. range Accuracy	t_{99s}	Connection cable	Part no.
Quick–action surface probe with sprung thermocouple strip	–200 to +300°C Short–term up to +500 °C Class 2	3	Plug–in head <small>Please order connection cable 0430.0143</small>	0604.0194 0614.0194*
Quick–action surface probe with sprung thermocouple strip, probe is bent at an angle of 90°	–200 to +300°C Short–term up to +500 °C Class 2	3	Plug–in head <small>Please order connection cable 0430.0143</small>	0604.0994 0614.0994*
Robust surface probe	–200 to +600°C Short–term up to +1100°C Class 1	25	Plug–in head <small>Please order connection cable 0430.0143</small>	0604.9993 0614.9993*
Robust surface probe , bent at an angle of 90° for inaccessible places	–200 to +600°C Class 1	25	Plug–in head <small>Please order connection cable 0430.0143</small>	0604.9893 0614.9893*
Robust surface probe , with sprung thermocouple for high measuring range up to +700 °C	–200 to +700°C Class 2	3	Coiled cable PUR	0600.0394
Pipe clamp probe , for pipes with a 2" diameter	–60 to +130°C Class 2	5	1.5 m PVC	0600.4593
Spare measuring head				0602.0092
Magnetic probe a) for measurements on metallic surfaces, adhesive force 20 N b) for higher measurements, adhesive force 10 N	–50 to +170 °C –50 to +400 °C Class 2		Silicone fibre glass a)+b) 1.5 m	0600.4793 0600.4893
Flat head probe with telescope for quick measurements in places which are difficult to access	–50 to +250°C Class 2	<3	1.8 m PVC	0600.2394
Miniature probe for measurements on electronic components, small motors..	–200 to +400°C Short–term to +500 °C Class 2	3	1.5 m PVC	0600.1494
Roller probe for surface measurements on rollers and rotating cylinders, perm. circumferential speed 18 to 400 m/min	50 to +240°C Class 2	–	Coiled cable PUR	0600.5093
NiCr–Ni immersion/penetration probes	Meas. range Accuracy	t_{99s}	Connection cable	Part no.
Rapid response immersion/penetration probe	–200 to +400°C Class 1	3	Plug–in head <small>Please order connection cable 0430.0143</small>	0604.0293 0614.0293*
Quick action immersion/penetration probe for measurements in liquids	–200 to +600°C Class 1	1	Plug–in head <small>Please order connection cable 0430.0143</small>	0604.0493 0614.0493*
Quick action immersion/penetration probe for high temperatures	–200 to +1100°C Class 1	1	Plug–in head <small>Please order connection cable 0430.0143</small>	0604.0593 0614.0593*
Quick action immersion/penetration probe for measurements in gases and liquids with a slim tip, low in mass	–200 to +600°C Class 1	<1	Plug–in head <small>Please order connection cable 0430.0143</small>	0604.9794 0614.9794*

*with EEPROM - Precision adjustment for each probe at one measuring point - measuring range limits are saved in probe

Ordering data

Temperature probes for testo 645 / 445

NiCr–Ni immersion/penetration probes	Meas. range Accuracy	t_{99s}	Connection cable	Part no.
Robust immersion/penetration probe , made of V4A stainless steel, water–proof and boil–proof, e.g. for the food sector	–200 to +400 °C Class 1	3	1.5 m silicone	0600.2593
Smelting probe for measurements during non–ferrous smelting, with exchangeable measuring tips. Lifetime of measuring tip extends up to 500 measurements in aluminium smelting. Spare measuring tip	–200 to +1250 °C	60	1.5 m PVC	0600.5993 0363.1712
Plug–in measuring tips Ø 3 for high temperatures, bendable. Please also order handle (see below)	a) Stainless steel outer coating 1.4541 L 750 b) Stainless steel outer coating 1.4541 L 1200 c) Inconel outer coating 2.4816 L 550 d) Inconel outer coating 2.4816 L 1030	–200 to +900 °C –200 to +900 °C –200 to +1100 °C –200 to +1100 °C All Class 1	3.5 3.5 3.5 3.5	0600.5393 0600.5493 0600.5793 0600.5893
Handle for plug–in measuring tips			PUR coiled cable	0600.5593
NTC probe	Meas. range Accuracy	t_{99s}	Connection cable	Part no.
Very accurate probe for air and gas temperature measurements with open, mechanically protected sensor.	–40 to +130 °C NTC to UNI curve	60	PUR coiled cable	0610.9714
NiCr–Ni thermocouples	Meas. range Accuracy	t_{99s}	Connection cable	Part no.
Thermocouple made of thermal cables insulated with fibre glass Pack of 5.	Highest temp. +400 °C Class 1		Please order adapter 0600.1693	0644.1109
Thermocouple, adhesive carrier material: aluminium foil Pack of 2.	Highest temp. +200 °C Class 1		Please order adapter 0600.1693	0644.1607
Adapter to connect NiCr–Ni thermocouples and probes with open wire ends			0.3 m PVC	0600.1693
Other temperature probes	Meas. range Accuracy	t_{99s}	Connection cable	Part no.
Globe thermometer for the measurement of radiation heat NTC sensor, Ø of ball is approx. 150 mm	0 to +120 °C ±0.5 °C (0 to +50 °C) ±1 °C (+50 to +120 °C)		1.5 m	0554.0670
Infrared probe for non–contact temperature measurement on live, inaccessible and rotating parts.	–18 to +260 °C ±2 % of m.v. with E = 0.95	2	PUR coiled cable	0600.0750

* With EEPROM: Precision adjustment for each probe at a measuring point
Measuring range limits are saved in probe

Ordering data

Temperature probes for testo 645 / 445

Accessories for temperature probes	Part no.
Silicone heat paste (14g), T _{max} = +260 °C to improve heat transfer in surface probes	0554.0004
Connection cable for probes, 1.5 m long, PUR	0430.0143
Connection cable for probes with plug-in head, 5 m long, PUR coating material	0430.0145
Extension cable between plug-in cable and instrument 5 m long, PUR coating material	0409.0063
Telescope for probe with plug-in head, extension length: max. 1 m, 2.5 m cable, PUR coating material	0430.0144

Temperature probes for testo 645

Pt100 surface probes	Meas. range Accuracy	t _{99s}	Connection cable	Part no.
Robust surface probe	-50 to +400°C Class B	40	Plug-in head Please order connec- tion cable 0430.0143	0604.9973 <i>0628.0018*</i>
Velcro probe for pipes with Ø of max. 100 mm	-50 to +150°C Class B	40	1.6 m PTFE Ribbon cable	0628.0019
Pt100 immersion/penetration probes	Meas. range Accuracy	t _{99s}	Connection cable	Part no.
Standard immersion/penetration probe Pipe: stainless steel Pipe: Nickel	-200 to +400°C	20	Plug-in head	0604.0273
	-200 to +600°C Class A	20	Plug-in head Please order connec- tion cable 0430.0143	0604.0274
Highly accurate immersion/penetration probe	-100 to +400°C 1/10 Class B **	30	Plug-in head Please order connec- tion cable 0430.0143	<i>0628.0015*</i>
Protective glass for immersion/penetration probes 0604.0273 and 0628.0015				0554.7072
Flexible precision immersion probe , cable between handle and sensor tip, heat-proof up to +300 °C	100 to +300°C 1/10 Class B **	80	Plug-in head Please order connec- tion cable 0430.0143	<i>0628.0016*</i>
Robust probe with sharpened measuring tip, water-proof and boil-proof	-200 to +600°C Class A	30	1.5 m Silicone	0604.2573
Pt100 air probes	Meas. range Accuracy	t _{99s}	Connection cable	Part no.
Standard air probe	-200 to +600°C Class A	75	Plug-in head Please order connection cable 0430.0143	0604.9773
Precision air probe	-100 to +400°C 1/10 Class B **	75	Plug-in head Please order connection cable 0430.0143	<i>0628.0017*</i>

* With EEPROM: Precision adjustment for each probe at a measuring point **1/10 Class B (0 to +100 °C) 1/5 Class B (rem. range) to EN 60751

Ordering data

Humidity probes for testo 645 / 445

Humidity/temperature probes for air conditioning/ventilation sector	Measuring range	System accuracy*	t _{99s}	Connection cable	Part no.
Standard indoor air quality probe up to +70 °C	0 to 100 %RH (probe tip) -20 to +70°C	±2 %RH (2 to 98 %RH) ±0.4°C(0 to 50°C) ±0.5 °C (rem. range)	<12 at 2m/s	Plug-in head Please order connection cable 0430.0143	0636.9740
Duct humidity/temperature probe Telescope extension can be connected	0 to 100 %RH (probe tip) -20 to +70°C	±2 %RH (2 to 98 %RH) ±0.4°C(0 to 50°C) ±0.5 °C (rem. range)	<12 at 2m/s	3 m PUR	0636.9715 0430.9715
Telescope , 340 to 800 mm long					
Highly accurate reference humidity/temp. probe incl. calibration certificate	0 to 100 %RH (probe tip) -20 to +70°C	±1%RH (10 to 90 %RH from +15 to +30°C) ±2%RH (rem. range plus Tcomp.) ±0.4°C (0 to 50°C) ±0.5°C (rem. range)	<12 at 2m/s	Plug-in head Please order connection cable 0430.0143	0636.9741
Flexible humidity probe with mini module for measurements e.g. on material test rigs. Module cable length: 1500 mm. Module dimensions in mm: 50 x 19 x 7(lxwxh)	0 to 100 %RH -20 to +125°C	± 2%RH (2 to 98 %RH) ±0.4°C(0 to 50°C) ±0.5 °C (rem. range)	20	Plug-in head Please order connection cable 0430.0143	0628.0013
Humidity/temperature probes for tough industrial applications	Measuring range	System accuracy*	t _{99s}	Connection cable	Part no.
Sword for humidity/temperature measurement in stacked material	0 to 100 %RH (probe tip) -20 to +70°C	±2 %RH (2 to 98 %RH) ±0.4°C(0 to 50°C) ±0.5 °C (rem. range)	<12 at 2m/s	Plug-in head Please order connection cable 0430.0143	0636.0340
Robust humidity probe e.g. for measuring material moisture equilibrium or for measurements in exhaust ducts up to +120 °C	0 to 100 %RH -20 to +120°C	±2 %RH (2 to 98 %RH) ±0.4°C(0 to 50°C) ±0.5 °C (rem. range)	<30 at 2m/s	Plug-in head Please order connection cable 0430.0143	0636.2140
Robust high temperature probe up to +180 °C	0 to 100 %RH -20 to +180°C	±2 %RH (2 to 98 %RH) ±0.4°C(0 to 50°C) ±0.5 °C (rem. range)	<30 at 2m/s	Plug-in head Please order connection cable 0430.0143	0628.0021
Flexible humidity probe, does not retain shape for measurements in inaccessible places	0 to 100 %RH -20 to +180°C	±2 %RH (2 to 98 %RH) ±0.4°C(0 to 50°C) ±0.5 °C (rem. range)	<30 at 2m/s	Plug-in head Please order connection cable 0430.0143	0628.0022

Ordering data

Humidity probes for testo 645 / 445

Humidity/temperature probes for tough industrial applications	Measuring range	System accuracy*	t _{99s}	Connection cable	Part no.
Pressure-tight probes for measuring remaining moisture , e.g. in compressed air systems	0 to 100 %RH -30 to +50°C t _{pd}	-30 to +50°C t _{pd} ±0.9 to ±4°C t _{pd}	1 to 5 min typically 2 min	Plug-in head Please order connection cable 0430.0143	0636.9840
Pressure-tight precision probe for measuring remaining moisture , e.g. in compressed air systems	0 to 100 %RH -50 to +50°C t _{pd}	-40 to +50°C t _{pd} ±0.8 to ±4°C t _{pd}	1 to 5 min typically 2 min	Plug-in head Please order connection cable 0430.0143	0636.9841
Flexible, humidity probe (retains shape) for measurements in inaccessible places	0 to 100 %RH -20 to +140°C	±2 %RH (2 to 98 %RH) ±0.4°C(0 to 50°C) ±0.5 °C (rem. range)	<30 at 2m/s	Plug-in head Please order connection cable 0430.0143	0628.0014

* Accuracy data at rated temperature of +25 °C, temperature coefficient ± 0.03% / °C

Caps for all humidity probes with Ø 12 and 22 mm	Part no.
Metal protection cage , material: stainless steel V4A. Quick adjustment time, robust and temperature-proof. Application: for velocities < 10 m/s	Ø 21 mm 0554.0665 Ø 12 mm 0554.0755
Wire mesh filter , material: stainless steel V4A. Quick, adjustment time, protects from dirt and damage. Application: meteorology, splashwater, condensation.	Ø 21 mm 0554.0667
Insertable filter for metal protection basket and plastic cage.	
Cap with wire mesh filter	Ø 12 mm 0554.0757
PTFE sintered filter , PTFE material. Not affected by condensation, water-repellent, resistant to corrosive substances.	Ø 21 mm 0554.0666
Applications: compressed air measurements, high humidity range (long-term measurements), high velocities.	Ø 12 mm 0554.0756
Stainless steel sintered cap , material: V2A stainless steel. Very robust, suitable for penetration, should be cleaned with fresh air, mechanical protection of sensor. Application: large mechanical loads, high velocities.	Ø 21 mm 0554.0640 Ø 12 mm 0554.0647
Surface adapter for humidity probes Ø 12 mm, to localize damp spots	0628.0012
Accessories for humidity/temperature probes, 3-function probes	Part no.
Connection cable for probes with plug-in head, 1.5 m long, PUR coating material	0430.0143
Connection cable for probes with plug-in head, 5 m long, PUR coating material	0430.0145
Extension cable between plug-in head cable and instrument, 5 m long, PUR coating material	0409.0063
Telescope for probes with plug-in head, extension length: maximum 1 m, cable: 2.5 m, PUR coating material	0430.0144
Control and adjustment set 11.3 % / 75.3 % for humidity probes and 3-function probe (please order 0554.0661 adapter for 3-function probe)	0554.0660
Adapter for humidity adjustment in 0635.1540 3-function probe, order with adjustment set	0554.0661
Control and storage humidity (33 %) for humidity probe and 3-function probe (please order 0554.0661 adapter for 3-function probe)	0554.0636

Ordering data

Probes for testo 445

Pressure probes	Measuring range	Accuracy	Connection cable	Part no.
Pressure probe for measuring velocities and differential pressure or absolute pressure	-4 to 10 mbar	±0.03 mbar	1.5 m PUR	0638.1445
	-40 to 100 mbar	±0.1 mbar(0 to 20mbar)		0638.1545
	2000 mbar (Abs.p)	±0.5% of m.v. (rem.) ±5 mbar		0638.1645
Accessories for pressure probes	Temp.max	Material	Length/Ø	Part no.
Pitot tubes to measure velocity (in connection with pressure probes); longer versions on request	+350 °C	Chromium-plated brass	500mm/7 mm	0635.2045
	+350 °C	Chromium-plated brass	350mm/7 mm	0635.2145
	+500 °C	Stainless steel	300mm/4 mm	0635.2245
	+700 °C	Stainless steel	1000mm/7 mm	0635.2345
Silicone hose to connect Pitot tube and pressure probe, 5 m long				0554.0440
Magnetic holder for 0638.1445/0638.1545/0638.1645 pressure probes				0554.0225
Plug-in velocity probes		Meas. range	Accuracy (System)	Part no.
Vane probe , can be attached to handle or telescope Range of application: -30 to +140 °C		0.6 to 20 m/s	±(0.2 m/s + 1 % of m.v.)	0635.9443
Vane/temperature probe , can be attached to handle or telescope		0.4 to 60 m/s -30 to +140 °C	±(0.2 m/s + 1 % of m.v.)	0635.9540
Vane/temperature probe , can be attached to handle or telescope		0.4 to 40 m/s -30 to +140 °C	±(0.2 m/s + 1 % of m.v.)	0635.9640
Bendable vane probe for integrated velocity measurement Range of application: -20 to +60 °C		0.25 to 20 m/s	±(0.1 m/s + 1.5 % of m.v.)	0635.9440
Bendable vane probe for integrated velocity measurement Range of application: -20 to +60 °C		0.2 to 15 m/s	±(0.1 m/s + 1.5 % of m.v.)	0635.9340
Accessories for plug-in vane probes			Connection cable	Part no.
Telescope for plug-in vane probes, max. 1 m long			2.3 m silicone	0430.0941
Extension for 0430.0941 and 0430.0944 telescopes, 2m long			Please connect connection cable 0409.0063	0430.0942
Handle for plug-in vane probes			1.5 m silicone	0430.3545
Swan neck , flexible connection between probe and connection part				0430.0001
Magnetic probe holder for vane probes				0554.0430

Ordering data

Probes for testo 445

Velocity probes with handle/ telescope	Sensor	Measuring range	Accuracy (system)	Part no.
Low cost, robust hot bulb probe for measurements in the lower velocity range	Hot bulb NTC	0 to 10 m/s -20 to +70 °C	±(0.03 m/s +5% of m.v.)	0635.1549
Robust hot bulb probe with handle and telescope for measurements in the lower velocity range	Hot bulb NTC	0 to 10 m/s -20 to +70 °C	±(0.03 m/s +5% of m.v.)	0635.1049
Quick-reaction hot wire probe with telescope for measurements in the lower velocity range with direction recognition function	Hot wire NTC	0 to 20 m/s -20 to +70 °C	±(0.03 m/s +4% of m.v.)	0635.1041
Vane probe with telescope $T_{\max} +60^{\circ}\text{C}$	Vane	0.6 to 40 m/s	±(0.2 m/s +2 % of m.v.)	0628.0005
Vane probe for integrating velocity measurement with telescope, $T_{\max} +60^{\circ}\text{C}$	Vane	0.25 to 20 m/s	± (0.1 m/s +1.5 % of m.v.)	0635.9449
High temperature probe with handle for long-term measurements up to +350 °C	Vane NiCr-Ni	0.6 to 20 m/s -40 to +350 °C	±2.5 % of final value	0635.6045
Accessories for velocity probes		Measuring range	Length/Ø	Part no.
Volume flow funnel to measure the extraction capacity in ventilation systems		a) 20 to 400 m ³ /h b) 20 to 400 m ³ /h	190x190 mm 350x350 mm	0554.0400 0554.0410
Extension cable between connection cable and instrument for plug-in vanes		5 m	0409.0063 PUR	
Cap for test holes (50 off)			Ø 25.4 mm	0554.4001
Additional probes	Sensor	Measuring range	Accuracy	Part no.
3-function probe for simultaneous measurement of temperature, humidity and velocity. With plug-in head (please order 0430.0143 connection cable)	Hot bulb Capacitive NTC	0 to 10 m/s 0 to 100 %RH (probe tip) -20 to +70 °C	±(0.03 m/s +5 % of m.v.) ±2 %RH (2 to 98 %RH) ±0.4 °C (0 to 50 °C) ±0.5 °C (rem. range)	0635.1540
Comfort level probe for meas. degree of turbulence, with telescope and stand. Fulfills the requirements of DIN 1946 Part 2 or VDI 2080	Hot wire NTC	0 to 5 m/s 0 to 50 °C	±(0.03 m/s +4 % of m.v.) ± 0,3 °C	0628.0009
CO₂ probe for measuring indoor air quality and for monitoring workplace conditions		0 to 10,000 ppm 0 to 1 vol. %	±50 ppm ±2 % of m.v. (0 to 5000 ppm) ±100 ppm ±3 % of m.v. (remaining range)	0632.1240
CO probe		0 to 500 ppm	±5 ppm (0 to 100 ppm) ±5 % of measured value remaining range	0632.1247



testo AG

Postfach 11 40, 79849 Lenzkirch

Testo-Straße 1, 79853 Lenzkirch

Telefon: (07653) 681-0

Fax: (07653) 681-100

E-Mail: info@testo.de

Internet: <http://www.testo.com>