

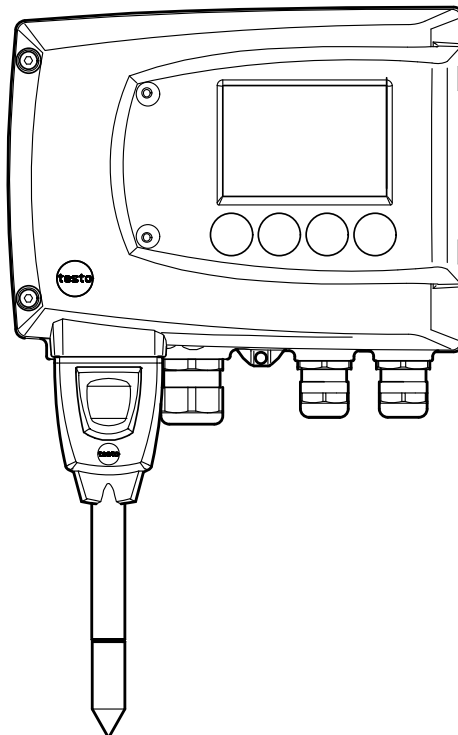

testo 6651 · Humidity transmitters
testo 6600 · Probes
P2A software · Parameterizing, adjusting and analyzing
software

Instruction manual Volume 2

en



Contents

2	TESTO 6600 PROBES	64
2.1	Specifications.....	64
2.1.1	Functions and use.....	64
2.1.2	Probe assembly	66
2.1.3	Accessories.....	67
2.2	Product description	67
2.2.1	Overview of probe and filter types	67
2.2.2	testo 6601 wall probe.....	70
2.2.3	testo 6602/6603 duct probe	74
2.2.4	testo 6604/6605 cable probe	78
2.3	Commissioning	81
2.3.1	Installing the probe.....	81
2.3.2	Connecting/removing the probe to/from the transmitter	83
2.4	Maintenance and cleaning.....	84
2.4.1	Replacing filters/protection caps.....	84
2.4.2	Cleaning the instrument and filter/protection cap	87
2.4.3	Replacing the sensors	87
3	PARAMETERIZING, ADJUSTING AND ANALYZING SOFTWARE (P2A SOFTWARE)	89
3.1	Specifications.....	89
3.1.1	Functions and use.....	89
3.1.2	System requirements	90
3.1.3	Scope of delivery	90
3.2	First steps	91
3.2.1	Installing the software/driver	91
3.2.2	Starting the software	92
3.3	Using the software	93
3.3.1	User interface.....	93
3.3.2	Editing instrument/parameter file	95
3.3.3	Analyzing/testing the transmitter.....	104
3.3.4	Adjusting the transmitter	109
3.3.5	Transmitter history	114
4	TIPS AND ASSISTANCE.....	120
4.1	Questions and answers	120
4.2	Accessories and spare parts	121
4.2.1	Ordering options for testo 6651 transmitter (0555 6651)	123
4.2.2	Ordering options for testo 6600 probes (0555 6600).....	125

2 testo 6600 probes

2.1 Specifications

2.1.1 Functions and use

The plug-in, adjusted probes from the testo 6600 range are used in conjunction with the testo 6651 humidity transmitter.

These measuring units are suitable for the following applications, for example:

- Process instrumentation
- Test benches
- Production and storage air quality
- Complex room climate applications

2.1.1.1 Digital probes:

The probes are adjusted in the factory and transmit their adjustment data to the internal memory of the testo 6651 transmitter. The information is transmitted between the probe and transmitter in a purely digital form. The probes can therefore be disconnected from the transmitter for adjustment or servicing while the transmitter itself can remain at the measuring point.



Hint:

We recommend in this case that a probe of the same type be inserted into the transmitter immediately in order to be able to continue measuring with minimal interruption.

The transmitter identifies the probe and records that a probe was connected in the history.



The testo 6651 transmitter cannot be run with the testo 6610 probes; testo 6600 probes must be used.

2.1.1.2 The Testo humidity sensor

With the Testo humidity sensor, which has been in successful use and continually improved for more than ten years, the focus has from the very beginning been on both accuracy parameters, namely measuring uncertainty and long-term stability.

The capacitive humidity sensor is in principle a plate capacitor consisting of two electrically conductive plates (electrodes **(1)** and **(2)**, see diagram below) opposite each other.

A humidity-sensitive polymer (**5**) serves as the dielectric. The special feature lies in the perfect way the individual layers are matched to each other. This is evident particularly in the top electrode, which has to perform two tasks that, at first glance, appear contradictory: it must be completely permeable to the water vapour that is to be fed into the polymer dielectric, but at the same time it must be impervious, smooth and repellent to condensate, oil and dirt in order to protect the sensor.

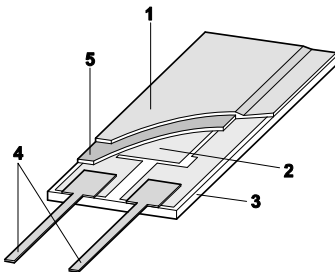

- 1 Cover electrode
- 2 Bottom electrode
- 3 Substrate
(Ceramic substrate for
mechanical protection)
- 4 Connections
(protected against corrosion)
- 5 Dielectric layer

2.1.1.3 Self-diagnosis

The probes in the testo 6600 range monitor their functionality themselves and report the following faults:

- Sensor breaks
- Sensor short-circuit
- Condensation
 - The condensation message is issued at a reading of 100 % RH and deactivated once the readings are within the valid range.
- Error message with drift at the adjustment points
- Value for relative humidity less than 0 % RH.
 - The trigger threshold is set at -2 % RH. This means that an error message is only issued once a clear effect is discernible.
- Adjustment monitoring with and without PC
- Operating hours
- Excess temperature
 - Error message if the permissible process temperature is exceeded

2.1.2 Probe assembly

The probes of the testo 6600 range are made up of the following components (included in delivery):

- Probe connector
- Probe shaft with protection cap and sensors (% RH and °C or °F)
- Mounting bracket (for testo 6602/6603 duct version)
- Probe cable (testo 6602 to 6605 duct and cable versions), bend radius minimum \varnothing 50 mm.

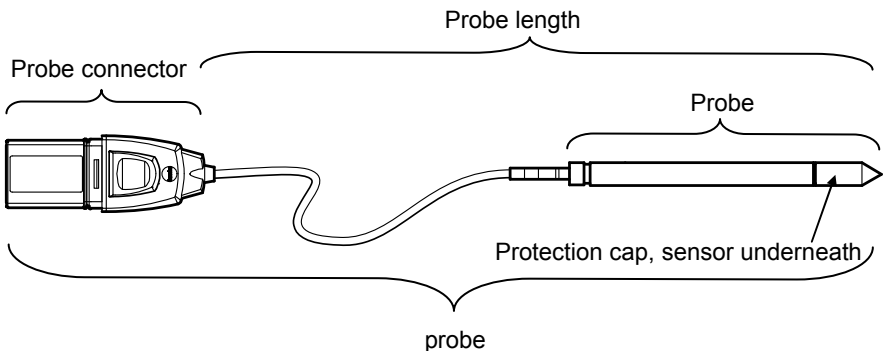

2.1.3 Accessories

The following accessories are available for probes in the testo 6600 range:

- Filters and protection caps (see *chapter 2.2.1.4, page 70*)
- Calibration certificate in accordance with ISO and DAkkS (see *chapter 4.2, page 121*).

2.2 Product description

2.2.1 Overview of probe and filter types

2.2.1.1 Probe version



A detailed description of the probe versions can be found from *chapter 2.2.2, testo 6601 wall probe, page 70*.

The following probe versions are available for the testo 6651 humidity transmitter:

probe	Article no.	Characteristic
testo 6601	0555 6600-L01	Wall probe version; accuracy to $\pm 1,7$ % RH; temperature range -20 °C to +70 °C/-4 to +158 °F, Sensor plugged
testo 6602	0555 6600-L02	Duct probe version; accuracy to ± 1.7 % RH; temperature range -20 °C to +70 °C/-4 to +158 °F, Sensor plugged
testo 6603	0555 6600-L03	Duct probe version; accuracy to $\pm 1,7$ % RH; temperature range -30 °C to +120°C/-22 to +248 °F, Sensor plugged
testo 6604	0555 6600-L04	Cable probe version; accuracy to ± 1.7 % RH; temperature range -20 °C to +70 °C/-4 to +158 °F, Sensor plugged
testo 6605	0555 6600-L05	Cable probe version; accuracy to ± 1.7 % RH; temperature range -30 °C to +120°C/-22 to +248 °F, Sensor plugged

2.2.1.2 Determining the accuracy/measuring uncertainty

The entries for the measuring uncertainty for the probe are determined in accordance with GUM (Guide to the Expression of Uncertainty in Measurement/DIN V ENV 13005). All parts that make up the measuring uncertainty given by Testo are listed below. When comparing the measuring uncertainty/accuracy between manufacturers, which components are included is to be taken into account. In many cases, not all elements that contribute to measuring uncertainty are assessed, for example if the error contribution of the production adjustment is shown separately or not at all.

The measuring uncertainty of the probe includes the sensor and its electronics as well as the output of the digital measuring signal:

- 1. Linearity including scatter** Systematic error and scattering of the components (due to manufacturing tolerances)

- 2. Hysteresis** Hysteresis indicates the maximum deviation of the readings that are obtained when you set the same value for the parameter, once coming from a smaller value, once coming from a larger value (humidity sensors actually have no hysteresis, but rather very slow adjustment effects that appear to be hysteresis when considered only for a short period.)

- 3. Reproducibility** Repeatability (scattering of the readings in the event of the same parameter being entered successively)

- 4. Production adjustment area** The measuring uncertainty of the adjustment area (including the reference instrument) in production

- 5. Uncertainty of the testing** Uncertainty of the procedure for determining points 1 and 2.

2.2.1.3 Ordering options for testo 6600 probes (0555 6600)

Order code	Characteristic
Lxx Probe type	
L 01	Probe 6601
L 02	Probe 6602
L 03	Probe 6603
L 04	Probe 6604
L 05	Probe 6605
Mxx Protective filter	
M 01	Stainless steel sintered filter
M 02	Metal wire protection cap
M 03	Sintered PTFE filter
M 04	Open metal protection cap
M 05	ABS plastic cap (open)
Nxx Cable length	
N 00	Without cable (testo 6601)
N 01	1 m cable length (testo 6604, 6605)
N 02	2 m cable length (testo 6604, 6605)
N 05	5 m cable length (testo 6605)
N 23	Cable length specifically for duct versions (testo 6602, 6603)
Pxx Probe length	
P 07	Probe length approx. 70 mm (testo 6601)
P 14	Probe length approx. 140 mm (testo 6604)
P 20	Probe length approx. 200 mm (testo 6601, 6605)
P 28	Probe length approx. 280 mm (testo 6602, 6603, 6604)
P 50	Probe length approx. 500 mm (testo 6605)

2.2.1.4 Filters

One of the following filters or protection caps can be used for each probe version:

Filter*	Article no.**	Characteristic	Length A (mm)
M 01	0554 0647	Stainless steel sintered filter	33
M 02	0554 0757	Metal wire protection cap	40,3
M 03	0554 0759	Sintered PTFE filter	35
M 04	0554 0755	Open metal protection cap	35
M 05	0192 0265	Open ABS plastic cap	25

* When ordering the probe, please use this filter code (see *chapter 2.2.1.3, Ordering options for testo 6600 probes (0555 6600), page 69.*

** When purchasing a replacement (filters only), please use this order number.

2.2.2 testo 6601 wall probe

The wireless testo 6601 probe is inserted into the testo 6651 humidity transmitter that is mounted on the wall and ready-wired.

At a glance

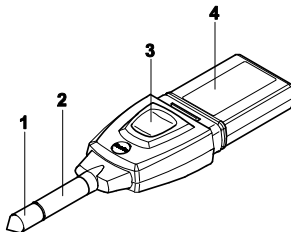

- 1 Filter (including: humidity and temperature sensor)
- 2 Probe shaft
- 3 Key
- 4 Connector



In the event of overpressures, the probe may become a projectile.

For assembly, see **Pressure resistance** on the following page.

Application

- Monitoring and regulating the production and storage air quality when manufacturing and storing hygroscopic products.

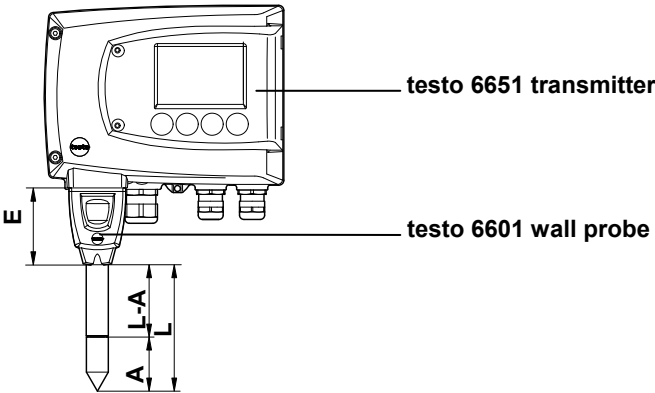

Technical Data

Parameters

- Humidity (% RH/°Ctd/°Ftd), etc.
- Temperature

Measuring range

- Humidity: 0 ... 100 % RH
- Temperature: - 20 ... 70 °C/-4 to +158 °F

Material

- Probe shaft: ABS plastic
- Connector: ABS plastic

Accuracy (at 25 °C/77°F)*

- Humidity
- Length 200 mm
- ± (1.7 % RH + 0.007 x reading) for 0 to 90 % RH
- ± (1.9 % RH + 0.007 x reading) for 90 to 100 % RH
- 0.02 % RH/K, dependent upon the process temperature (with a deviation of ± 25 °C/+77 °F)

- 0.02 % RH/K, dependent upon the electronics temperature (with a deviation of 25 °C/+77 °F)

- Temperature
- ±0.2 °C (±0.38 °F)

- Slope PT1000 class A

* Refer to the charts below for the correlation between temperature and accuracy.

- Length 70 mm
- As with length of 200 mm, but with additional measuring error, specified for the operating mode 2 channels at 12 mA, without display light, relay off:

- Humidity: ±1.6 % RH (additional)
- Temperature: ±0.6 °C / ±1.1 °F (additional)

Reproducibility

- Better than ±0.2 % RH

Sensor

Response time without protective filter: t 90 max. 15 sec.

Probe dimensions

- Diameter of probe shaft: 12 mm
- E = 55 mm
- L = approx. 70 mm or 200 mm
- L – A = 35 mm or 165 mm
- A (see Table Filters, *chapter 2.2.1.4, page 70*).

Pressure resistance

- 1 bar positive pressure (probe tip)
**
- * Refer to the charts below for the correlation between temperature and accuracy.
- ** If installing probe under pressure, please use cutting ring screw connection (order no. 0554 1795).

Measuring accuracy of testo 6601 wall probe

Humidity error according to amount $|\pm\% \text{ RH}|$ as a factor of process humidity

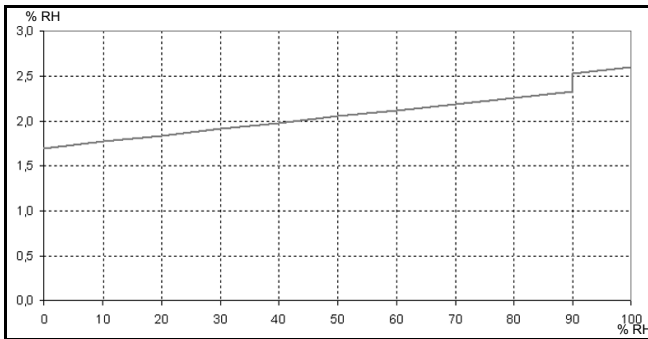

Temperature error as a factor of process temperature and temperature of electronics

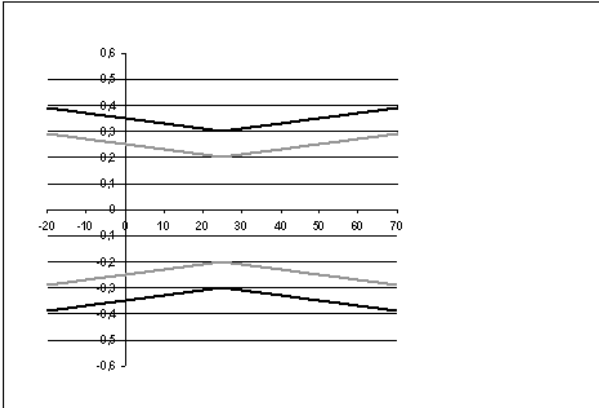

— System error 6681 + probe, electronics 25 °C/+77 °F
 — System error 6681 + probe, electronics -25 °C to +70 °C/-13 to +158 °F

2.2.3 testo 6602/6603 duct probe

The testo 6602/6603 probe measures the humidity and temperature in air ducts.

At a glance

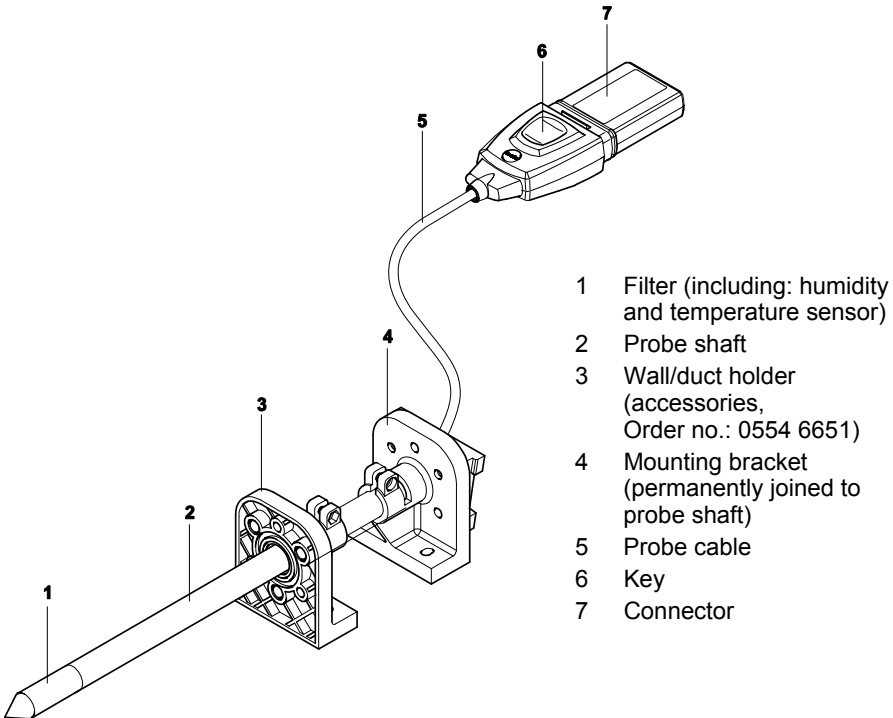

In the event of overpressures, the probe may become a projectile.

For assembly, see **Pressure resistance** on the following page.

Application

- Continuous measurement of humidity and temperature in air duct applications
- Monitoring and regulating the production and storage air quality in air ducts when manufacturing and storing hygroscopic products.

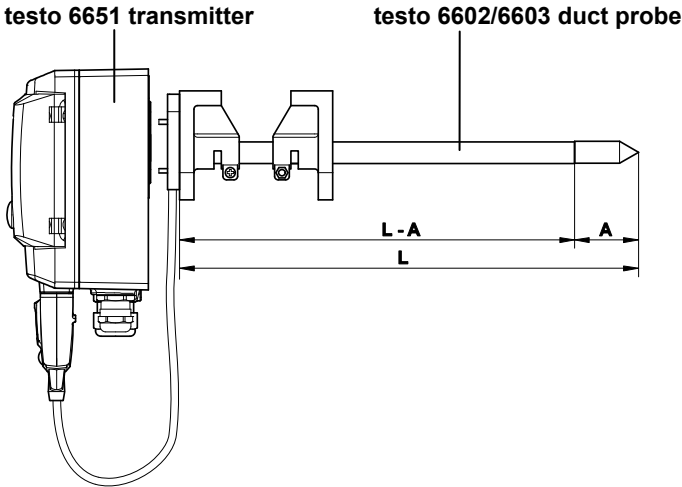

Technical Data

Parameters

- Humidity: (% RH/°Ctd/°Ftd), etc.
- Temperature

Measuring range

- Humidity: 0 ... 100 % RH
- Temperature for 6602: -20 ... +70 °C/-4 to +158 °F - 6603: - 30 ... +120 °C/-22 to +248 °F

Material

- Probe shaft: Plastic PA66GF30
- Line: Sheathed, FEP
- Connector: ABS plastic

Accuracy (at 25 °C/77°F)*

- Humidity
- ± (1.7 % RH + 0.007 x reading) for 0 to 90 % RH

- ± (1.9 % RH + 0.007 x reading) for 90 to 100 % RH
- 0.02 % RH/K, dependent upon the process temperature (with a deviation of 25 °C/+77 °F)
- 0.02 % RH/K, dependent upon the electronics temperature (with a deviation of 25 °C/+77 °F)
- Temperature
- ±0.2 °C (±0.38 °F)
- Slope PT1000 class A

Reproducibility

- Better than ±0.2 % RH

Sensor

Response time without protective filter: t 90 max. 15 sec.

Probe dimensions

- Diameter of probe shaft: 12 mm
- L = 280 mm
- L – A = 245 mm
- A (see Table *Filters, chapter 2.2.1.4, page 70*).

Cable length incl. probe shaft and filter

- Customized for duct version

Pressure resistance

- 1 bar positive pressure (probe tip)
**
- * Refer to the charts below for the correlation between temperature and accuracy.
- ** If installing probe under pressure, please use cutting ring screw connection (order no. 0554 1796).

Measuring accuracy of testo 6602/6603 duct probe

Humidity error according to amount $|\pm\% \text{RH}|$ as a factor of process humidity

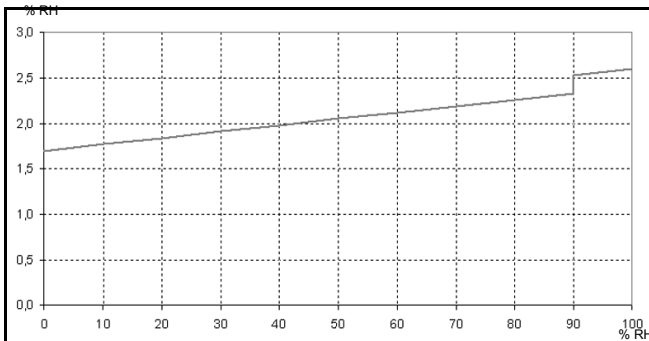

Temperature error as a factor of process temperature and temperature of electronics

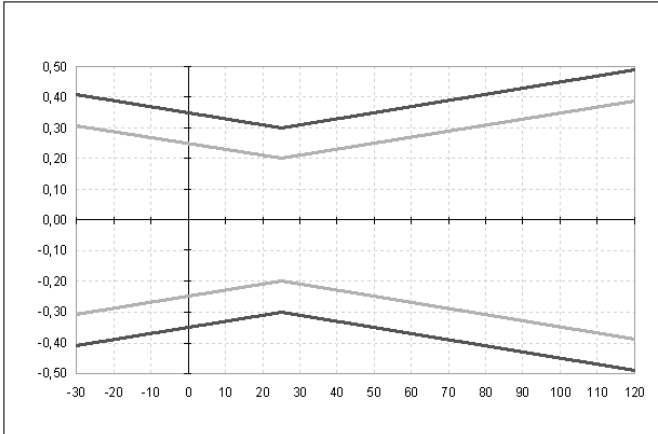

— System error 6681 + probe, electronics 25 °C/77 °F
— System error 6681 + probe, electronics -25 °C to +70 °C/-13 to

2.2.4 testo 6604/6605 cable probe

The testo 6604/6605 probes are used when the spatial separation of the transmitter and probe is required.

At a glance

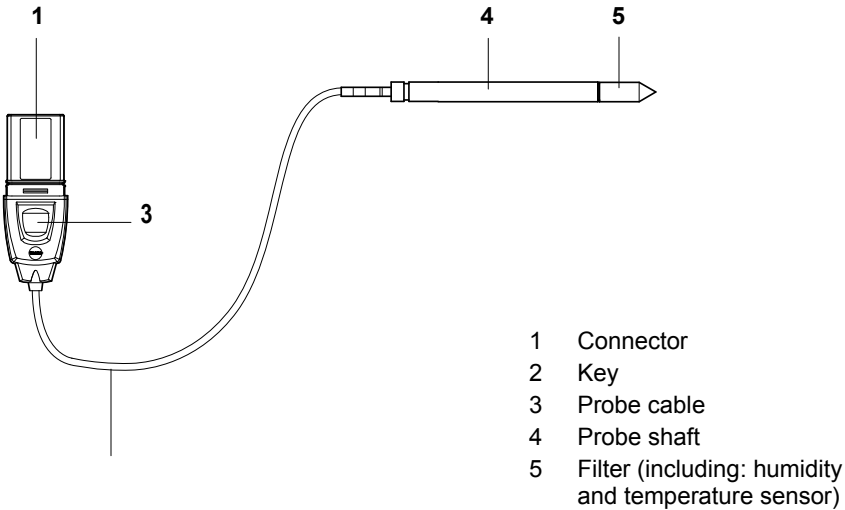

In the event of overpressures, the probe may become a projectile.

For assembly, see **Pressure resistance** on the following page.

Application

- Monitoring and regulating industrial humidity processes (apart from high-humidity processes), e.g. food production
- Monitoring the production and storage air quality when manufacturing and storing hygroscopic products.

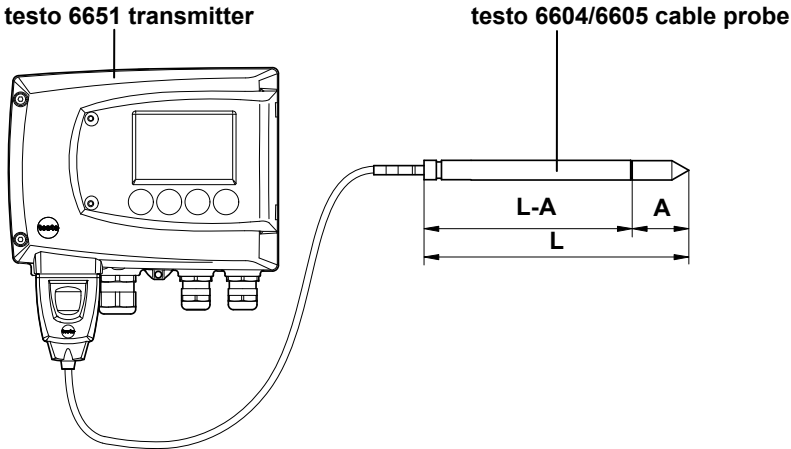

Technical Data

Parameters

- Humidity: (% RH/°Ctd/°Ftd)
- Temperature

Measuring range

- Humidity: 0 ... 100 % RH
- Temperature for
6604: -20 ... +70 °C/-4 to +158 °F -
6605: - 30 ... +120 °C/-22 to +248 °F

Material

- Probe shaft for
6604: Plastic PA66GF30
6605: Stainless steel
- Line: Sheathed, FEP
- Connector: ABS plastic

Accuracy (at 25 °C/77 °F)*

- Humidity
- ± (1,7 % RH + 0.007 x reading) for 0 to 90 % RH
- ± (1.9 % RH + 0.007 x reading) for 90 to 100 % RH
- 0.02 % RH/K, dependent upon the process temperature (with a deviation of 25 °C/+77 °F)

- 0.02 % RH/K, dependent upon the electronics temperature (with a deviation of 25 °C/+77 °F)
- Temperature
- 6604: ±0.2 °C (±0.38 °F)
- 6605: ±0,15 °C / ±0,27 °F
- 6604: Slope PT1000 class A
- 6605: Slope PT1000 class AA

Reproducibility

- Better than ±0.2 % RH

Sensor

Response time without protective filter: t 90 max. 15 sec.

Probe dimensions

- Diameter of probe shaft: 12 mm
- L = 6604 140/280 mm
L = 6605 200/500 mm
- L – A = 6604 105 mm/245 mm
- L – A = 6605 165 mm/465 mm
- A, see Table *Filters, chapter 2.2.1.4, page 70.*

Probe length incl. probe shaft and filter

- 1/2/5 m

Pressure resistance**

- testo 6604: 1 bar positive pressure (probe tip)
- testo 6605: PN 10 (probe tip)
- * Refer to the charts below for the correlation between temperature and accuracy.

** testo 6604: If installing probe under pressure, please use PTFE ring screw connection (order no. 0554 1796).

testo 6605: If installing probe under pressure, please use cutting ring screw connection (order no. 0554 1795).

Measuring accuracy of testo 6604/6605 cable probe

Humidity error according to amount $|\pm\% \text{ RH}|$ as a factor of process humidity

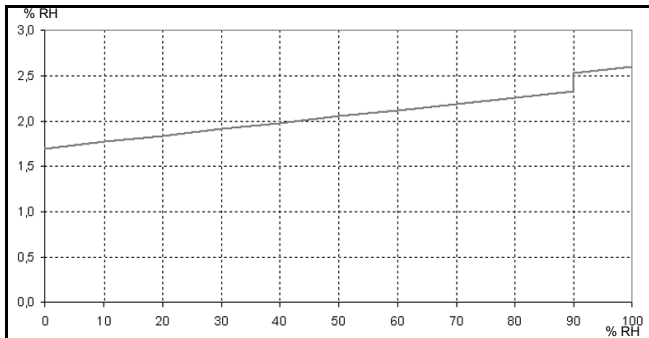

Temperature error as a factor of process temperature and temperature of electronics

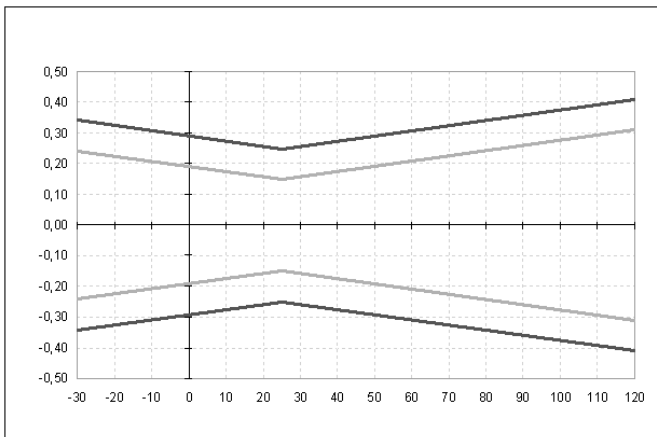

— System error 6681 + probe, electronics 25 °C/+77 °F
 — System error 6681 + probe, electronics -25 °C to +70 °C/-13 to

2.3 Commissioning

2.3.1 Installing the probe

2.3.1.1 Installing the testo 6601 wall probe

The testo 6601 probe (wall version) simply has to be inserted into the socket of the testo 6651 transmitter.

2.3.1.2 Install testo 6602/6603 duct probe

A description of the duct mounting of the testo 6602/6603 probe can be found in *volume 1, chapter 1.3.1.2, Duct mounting (for testo 6602/6603 probes), page 18.*

2.3.1.3 Install testo 6604/6605 duct probe

- ✓ If used with these probes, the testo 6651 transmitter is mounted on the wall (see *volume 1, chapter 1.3.1.1, page 16*).
- Install probe according to the application and the measuring and spatial conditions.



In processes with which condensate forms at the humidity probe, install the probe vertically (filter points downwards).

A Wall mounting of probe

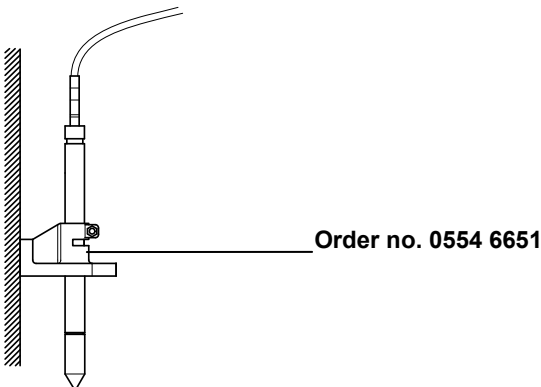

B Duct mounting of probe

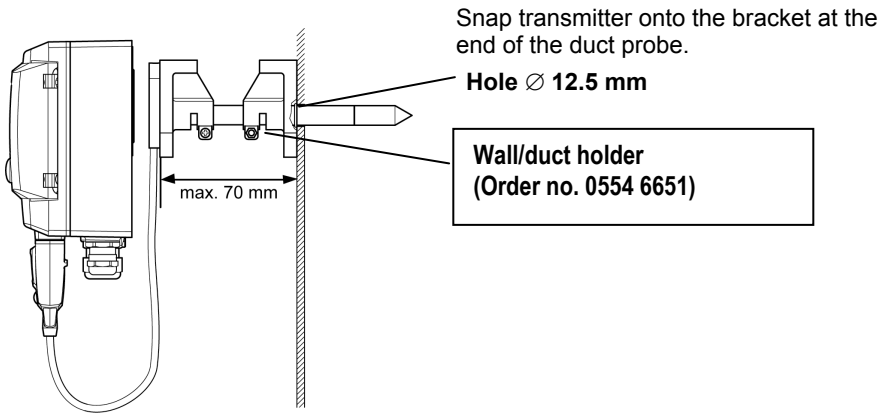

Atmospheric processes only. Alternatively, the single-hole duct holder (order no. 0554 1793) can also be used.

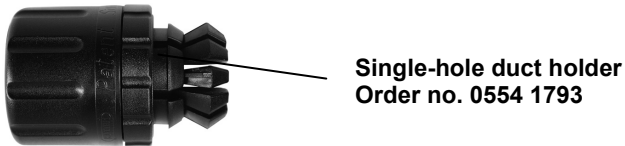

C Process mounting

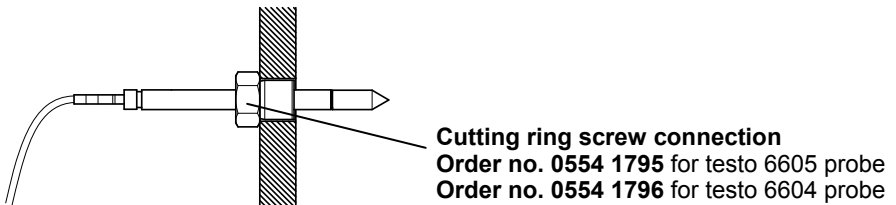

- During installation, ensure that the probe cannot be damaged during operation.

2.3.2 Connecting/removing the probe to/from the transmitter

- Insert probe connector into socket of testo 6651 until it engages. The testo 6651 identifies which probe is connected.

To remove the probe, the lock release button on the probe must be pressed so that this can be removed

2.4 Maintenance and cleaning

2.4.1 Replacing filters/protection caps

2.4.1.1 Replacing the filter/protection cap for testo 6601 wall version

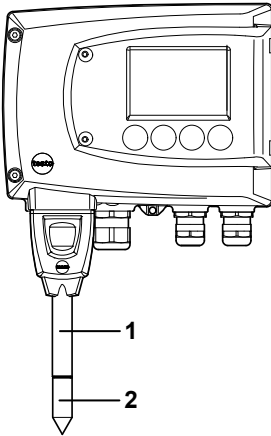

Do not damage the sensors when exchanging the filter/the protection cap and do not touch their surfaces!

- 1 Carefully unscrew defective filter/protection cap **(2)** from probe shaft **(1)**.
- 2 Carefully screw new filter/protection cap onto probe shaft.



Screw on protection cap by hand, i.e. do not tighten it using a tool.

2.4.1.2 Replacing the filter/protection cap for testo 6602/6603 duct version

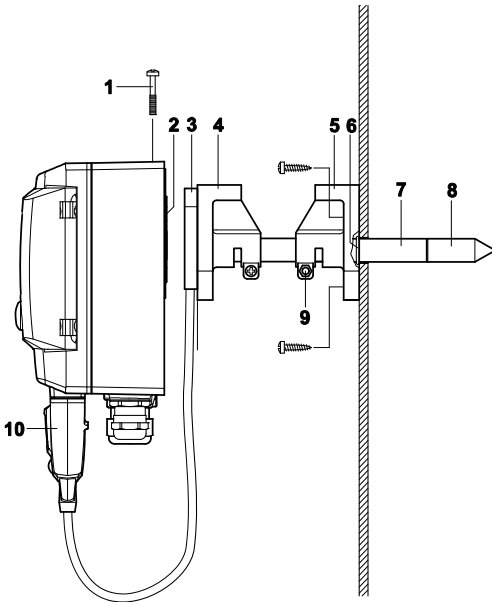

Do not damage the sensors when exchanging the filter/the protection cap and do not touch their surfaces!



Hint:

Mark the insertion length of the probe shaft near the screw (9).

- 1 Undo screw (9) and pull shaft probe (7) together with filter/protection cap (5) from the wall/duct holder (8).
- 2 Carefully unscrew defective filter/protection cap from probe shaft and carefully screw on new filter/protection cap.



Screw on protection cap by hand, i.e. do not tighten it using a tool.

- 3 Replace O-ring (6) if necessary. Push probe shaft into duct as far as the marking and fix position with screw (9).

2.4.1.3 Replacing the filter/protection cap for testo 6604/6605 cable version

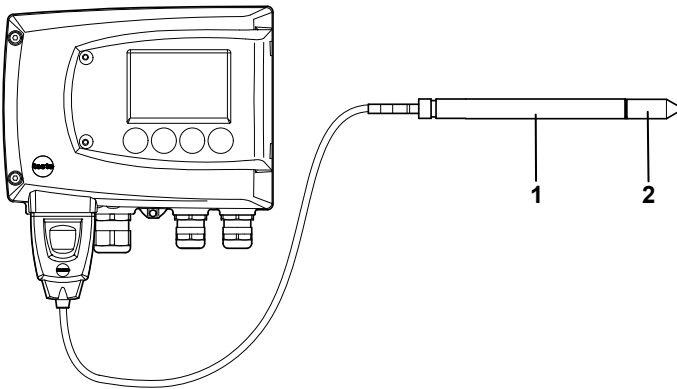

Do not damage the sensor when exchanging the filter/the protection cap and do not touch its surface!

- 4 Carefully unscrew defective filter/protection cap (2) from probe shaft (1).
- 5 Carefully screw new filter/protection cap onto probe shaft.



Screw on protection cap by hand, i.e. do not tighten it using a tool.

2.4.2 Cleaning the instrument and filter/protection cap

- Only clean the instrument carefully with a moist cloth.
- Do not use aggressive cleaning agents.
- Do not use any solvents.
- Unscrew cap or protection cap to clean, clean with compressed air and replace. Take care not to damage the sensor!

2.4.3 Replacing the sensors



It is not possible to replace the sensors with testo 6605.

As a result of the sensor concept, all sensors (except testo 6605) can be replaced as needed. In the process, all of the following steps must be adhered to.

- 1 Carefully unscrew filter/protection cap from probe shaft.
- 2 Remove defective sensor from slot with pincers.
- 3 Install new sensor in the slot.



During replacement, do not damage the sensor and do not touch its surface! Contamination and the smallest damages lead to incorrect measurement results.

- 4 Carefully screw filter/protection cap onto probe shaft.



Screw on protection cap by hand, i.e. do not tighten it using a tool.



To ensure the accuracy of the sensors,

- The humidity probe should then be adjusted using the control and adjustment set or in a humidity calibrator.

- The temperature should be adjusted using an appropriate reference.

The adjustment can also be performed by your Testo Service.

3 Parameterizing, adjusting and analyzing software (P2A software)

3.1 Specifications

The P2A software is used for the parameterizing, adjustment and analysis of testo transmitters. The following applies:

- Generally, all newer testo transmitters (as of 2007) are supported.
- Included with every testo transmitter that is bought new is a CD that contains a free upgrade of the software, which includes the device drivers for all transmitters that can be attached at this time.
- This upgrade can be downloaded at any time via the testo homepage "www.testo.com/Download/P2A".

The software must only be bought one time, even for owners of several testo transmitters.

3.1.1 Functions and use

In the P2A software, two different file types are used: The instrument and the parameter file.

Instrument file

The parameters of a particular transmitter are stored in its so-called instrument file. Using this file, the parameters can be edited and the instrument can be tested and adjusted.

Instrument files also contain the respective histories in addition to the parameter data, i.e. "log books" are kept for the previous parameterizations, adjustments and messages (see *chapter 3.3.5, page 114*).



Instrument files are ".cfm" format files.

Parameter file

Parameter files are not tied to a specific individual transmitter and contain only parameter data/no history data.

If you use various instruments of the same type, you can create parameter files once (e.g. by saving the appropriate instrument file as the parameter file) and transmit these onto the other instruments.



Parameter files are ".cfp" format files.

3.1.2 System requirements

Operating system

- Windows® 2000 SP4
- Windows® XP Home/Professional
- Vista

Computer

- Pentium processor of at least 400 MHz or equivalent
- 128 MB RAM
- Graphics resolution of at least 1,024 x 768
- Unused hard drive capacity of at least 15 MB
- CD-ROM drive
- USB interface
- At least Internet Explorer 5.0.

Software

The P2A software must be purchased and installed separately from the transmitter. If it is a new software version, the transmitter is already supported completely. Older P2A software versions can be updated via the P2A software upgrade (cf. product CD included with the transmitter).

3.1.3 Scope of delivery

Included in the scope of delivery are:

- P2A software
- USB driver



When working with the parameterizing, adjusting and analyzing software (P2A software), previous knowledge of Windows® operating systems is assumed. The description in this instruction manual relates to Windows® XP.

3.2 First steps

3.2.1 Installing the software/driver



Administrator rights are required to install programs and drivers under Windows® 2000 SP4, XP and Vista.

3.2.1.1 Installing P2A software

- 1 Insert CD with P2A software. If the installation program does not start automatically:
 - Open Windows Explorer and start the file **Setup.exe** on the product CD.
- 2 Follow the directions of the installation assistant.

3.2.1.2 Installing USB driver



Before installing the USB driver, please read the separate documentation that is enclosed with the USB driver CD.

3.2.1.3 P2A software upgrade

- 1 Insert product CD (supplied with the transmitter).
Open Windows® Explorer and start the file **P2A upgrade.exe** on the product CD.
- 2 Follow the directions of the installation assistant.

3.2.2 Starting the software

3.2.2.1 Starting the program

- Select: **[Start] > All Programs > Testo > P2A Software.**

The program window is opened (see *chapter 3.3.1, User interface, page 93*).

3.2.2.2 Establishing a connection with the instrument

Multiple instruments can be attached, however only one connection is active at all times.

- ✓ USB driver is installed (see *chapter 3.2.1, Installing the software/driver, page 91*).

- 1 Start the P2A software.
- 2 Connect adapter (supplied with the P2A software) to the service interface of the instrument (see *volume 1, chapter 1.2.4, Service interface, page 12*).
- 3 Connect instrument/adapter to the PC via the USB interface.

The instrument file of the attached instrument is shown in the file list.

3.2.2.3 Activating the connection with the instrument

- Click on the desired instrument file.

The selected file is marked in colour and the connection with the instrument is activated.

If a connection with the instrument is established when the program is started, the corresponding instrument file is marked automatically.

3.3 Using the software

3.3.1 User interface

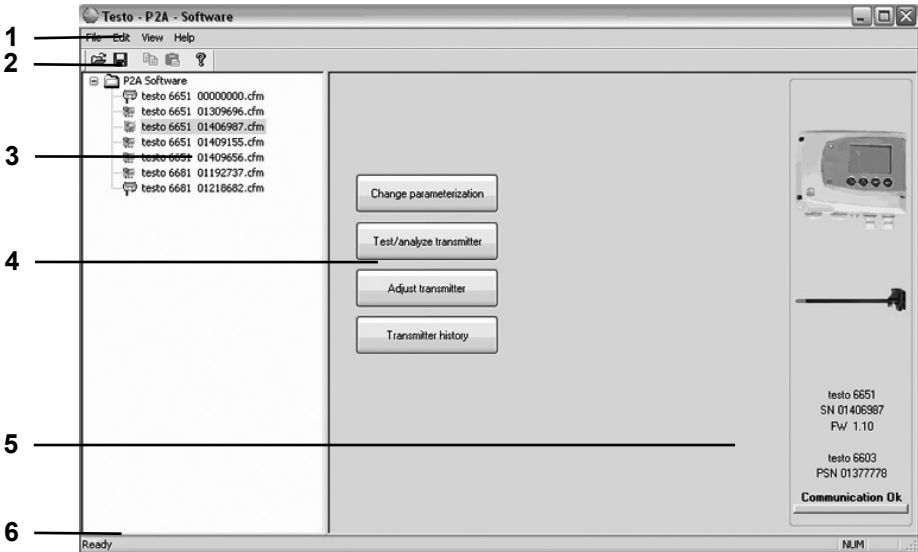

1 Menu bar:



Menu	Command	Explanation
File	Open	Shows the Windows dialogue for searching and opening files.
	Save as	Saves the parameters of an instrument or parameter file under a new name.
Edit	Copy	Copies the parameters of the marked instrument or parameter file in the cache.
	Paste	Pastes the parameters from the cache in the marked instrument or parameter file.
View	Toolbar Status bar	Activates/deactivates the toolbar or status bar.

Menu	Command	Explanation
?	Check instrument connections	Checks the connections to a connected instrument without the instrument having to be activated.
	Service	A text file with the most important information on the computer and the software is opened via Display service data .
	About	Shows the version number of the P2A software.

2 Toolbar:

Shows the Windows-compliant icons for editing.

3 File list:

Icon	File	Explanation
	Instrument file	Instrument file Connection to the instrument has been established. <Type> <Serial number>.cfm File name should not be changed.
	Instrument file	Instrument file Connection to the instrument has not been established.
	Parameter file	<Type> <Serial number> <Date> <Time>.cfp File name can be changed. The name can be selected freely, but it is recommended that you retain the reference to the instrument. Parameter files are always marked red; the parameter values they contain are only forwarded to the instrument after being transmitted to the instrument file.

4 Function buttons:

[Change parameterization] see chapter 3.3.2, *page 95*

[Test/analyze transmitter] see chapter 3.3.3, *page 104*

[Adjust transmitter] see chapter 3.3.4, *page 109*

[Transmitter history] see chapter 3.3.5, *page 114*

Dialogues on editing and testing the instrument are opened by means of the buttons.

5 File information:

Status	Shown in the window
Instrument file is selected	Type, serial number, firmware version of the instrument or probe.
Parameter file is selected	Type, serial number and firmware version of instrument for which the parameter file was created.
Connection status	Green = connection is active, Red = connection is inactive.

6 Status bar:

Shows the current status when editing via the menu bar.

3.3.2 Editing instrument/parameter file

3.3.2.1 Changing instrument/parameter file

✓ The desired instrument/parameter file is marked.

1 Click on **[Change parameterization]**.

The **Properties of <Instrument type> <Serial number>** dialogue is opened with the **Change parameterization** register.

If the parameters were transmitted from other parameter files into the instrument file, a message is shown with which you can transmit the new parameters to the connected instrument using **[Yes]**.

If the parameters should not be transmitted, click on **[No]**.

2 Change or enter parameters in the corresponding fields.

Unit/analog output

Explanation

All analog outputs are parameterized in this mask.

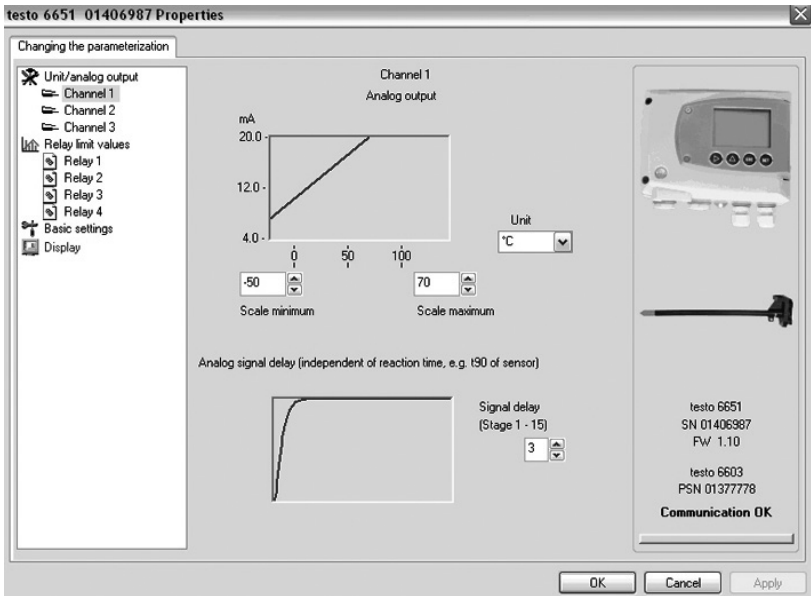

Unit/analog output (graphic)

Unit: 0 to 1 V/5 V/10 V or 4 to 20 mA.

Vertical: Current version of the analog output.

Horizontal: Min./max. scale end points of selected unit.

The curve changes in accordance with the entered value of scale minimum and maximum.

Scale minimum/maximum

The endpoints of the scaling can be selected up to the stored scale minimum and maximum. In the process, scaling can take place beyond the measuring range in order to adjust the analog output to the customer system.

Field	Explanation
Unit	<p>Selection of the physical unit.</p> <p>When changing the unit, standard values are set for scale minimum and maximum (see transmitter instruction manual for the scale final values).</p> <p>Caution!</p> <p>When changing the phys. unit, the relay limit values are set to the assigned default values.</p>
Signal delay (graphic)	<p>Curve changes according to the set signal delay.</p>
Signal delay	<p>Time interval in stages of 1 to 15: 1 = no delay 15 = longest delay.</p> <p>The signal delay is added to the reaction time of the sensor. The signal delay shows averaging over the time interval of the selected stage in seconds:</p> <p>Example</p> <p>Stage 10 = average of the readings from the last 10 seconds.</p>

Relay limit values 1 to 4

Explanation

In this mask, the relay is parameterized (if this transmitter option is available).



Only have the transmitter wired and connected by authorized personnel with the voltage disconnected.

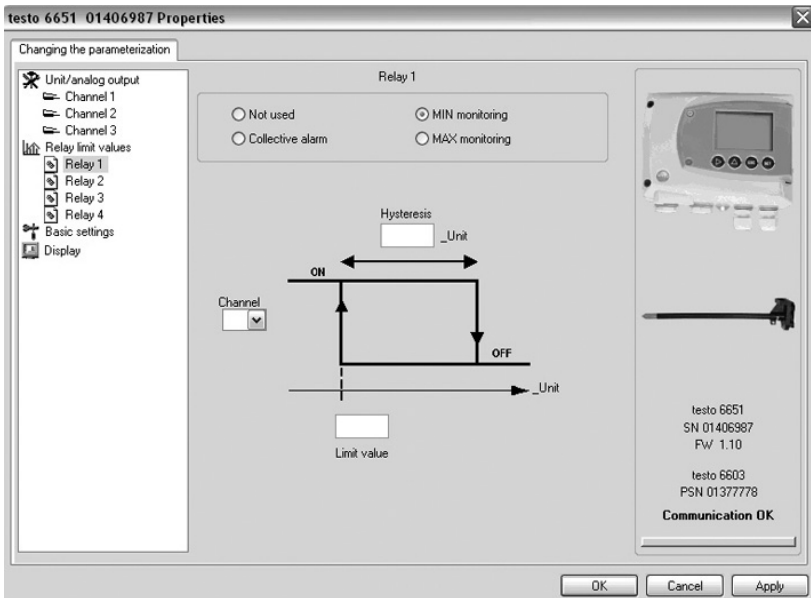

- Relay x Four relays are available (optional).
- Not used Relay is not used.
Hysteresis image and input options are hidden.
- Collective alarm A relay can be used as a collective alarm detector in the event that selected messages appear. See below for selection of the messages.
- MIN monitoring Switched to ON below the limit value;
switched to OFF when, following this, **Limit value** and **Hysteresis** are exceeded.
- MAX monitoring Switched to ON above the limit value;
switched to OFF when, following this, **Limit value** and **Hysteresis** are undershot.

Field	Explanation
Hysteresis	To avoid switching cycles.
Channel	Selection of the channel that is to be monitored.
Limit value	Values for the limits of the unit selected in Unit/analog output ; 1 decimal place. When changing the phys. unit, the relay limit values are set to the default values.
Collective alarm	Explanation Selection of the messages (error, etc.) that should result in a collective alarm (or linkage).

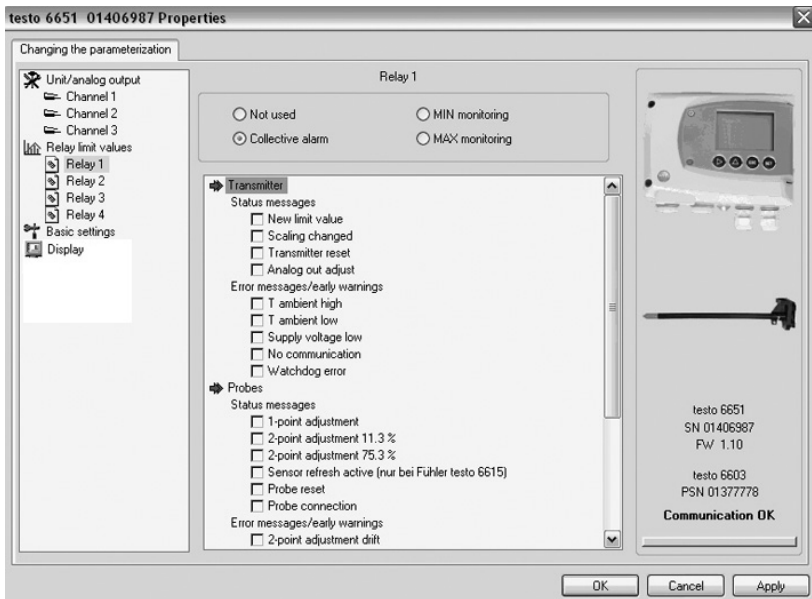

List field with checkboxes

Selection of which messages generated in the transmitter should be signalled as the collective alarm via the corresponding relay.

Basic settings

Explanation

Setting the absolute pressure

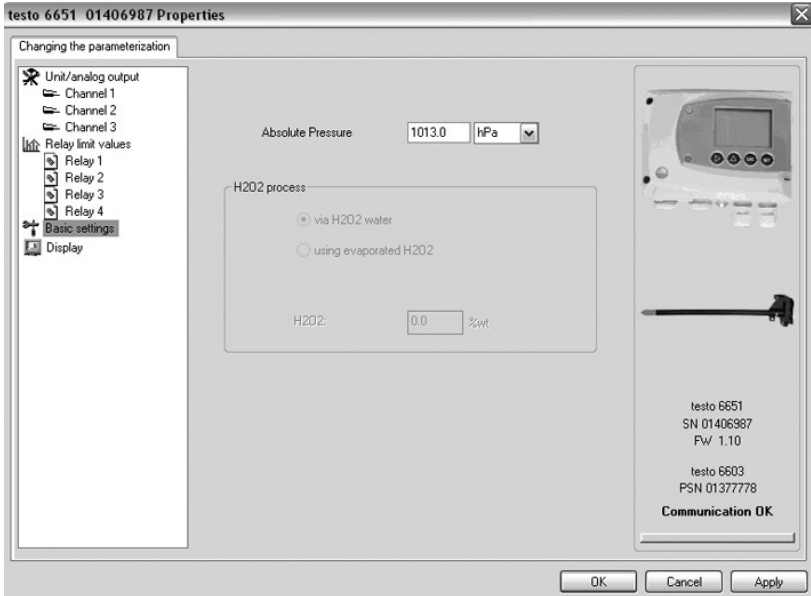

Absolute pressure

The absolute pressure is included in the calculation of the following units:

- °Ctd or °Ftd

Display

Explanation

Setting the display functions (if a display is available on the transmitter).

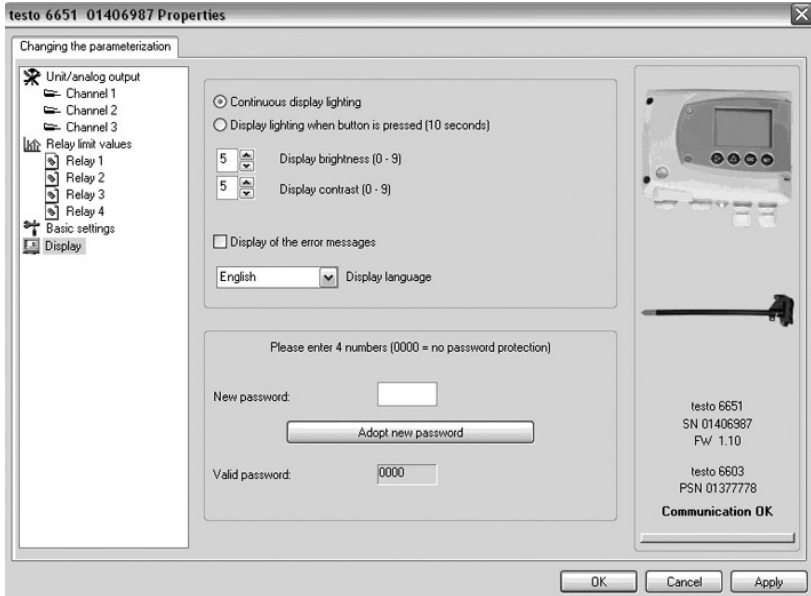

Continuous display lighting

Display lighting is permanently switched on.

Display lighting when button is pressed (10 seconds)

When a particular button on the instrument is pressed, the display lights up for 10 seconds.

Display brightness (0 to 9)

Setting the brightness between 0 and 9:
0 = dark
9 = light.

Display contrast (0 to 9)

Setting the contrast between 0 and 9:
0 = lower contrast
9 = higher contrast.

Field	Explanation
Display language	Selection of the language.
New password	The password consists of four numbers, each of which must be between 1 and 9. If the password protection is not to be used, the numerical code "0000" must be entered.
Adopt new password	Button for confirming the new password.
Valid password	Display of the current password.

3.3.2.2 Saving parameters

Parameters can be saved in new parameter files.

- 1 Mark instrument/parameter file
- 2 Click on **File > Save as** in the menu bar.
- 3 Select storage location and enter the file name.
- 4 Click on **[Save]**.

The new parameter file is shown in the file list.

Only the parameters are saved from an instrument file, the history data are not adopted.



The original name (Instrument type, Serial number) is suggested with the current date/time as standard, e.g. "testo 6681 01234578 061120 1403.cfp".

For a standard installation, the files are saved under "C:\Documents and Settings\All Users\Shared Documents\P2A Software". The path can differ depending on the version of the operating system.

3.3.2.3 Open parameter file

All parameter files stored in the standard directory path are automatically displayed in the file list when the software is started.

You can also open parameter files that are stored in other directories.

- 1 Click on **File > Open** in the menu bar.
- 2 Select the storage location and click on the requisite file.
- 3 Click on **[Open]**.

The selected file is opened. This can be changed and saved (see *chapter 3.3.2.2, page 102*).

3.3.2.4 Copying and pasting parameters

The parameters of a parameter file can be transmitted to an instrument file or another parameter file from the same instrument type.

- 1 Select file whose parameters are to be copied.
- 2 Click on **Edit > Copy** in the menu bar.
- 3 Select the file which is to be modified.
- 4 Click on **Edit > Paste** in the menu bar.

The parameters are transmitted to the file.



You can also use the common keyboard shortcuts for copying and pasting, i.e. CTRL C and CTRL V.

Parameters can also be transmitted using drag & drop, where you drag the icon of the parameter file onto the icon of the target instrument file.

3.3.2.5 Deleting instrument/parameter file

Instrument/parameter files can be deleted from the file list.

- 1 Click on the file that is to be deleted with the right mouse button.
- 2 Select the command **Delete** in the context menu.

The instrument or parameter file is deleted from the list.

3.3.3 Analyzing/testing the transmitter

In this section, you can test the outputs of the connected instrument, read off the limit values and reset the parameters to the factory settings.

The function is only available for instrument files.

3.3.3.1 Analyzing/testing the instrument

- ✓ The required instrument file is marked.

- 1 Click on **[Test/analyze transmitter]**.

The **Properties of <Instrument type> <Serial number>** dialogue is opened with the **Test/analyze transmitter** register.

- 2 Perform action:

Action	Explanation
Carry out factory reset:	Reset the unit, limit value and hysteresis parameters to factory settings (see <i>chapter 3.3.3.2, page 104</i>).
Test analog output:	Test channel 1/2.
Test switch outputs:	Manually switch relays 1 to 4 to test for proper function (see <i>chapter 3.3.3.3, page 105</i>).
Min./max. values display:	Overview of the minimum and maximum values measured since the last reset of the transmitter (see <i>chapter 3.3.3.5, page 108</i>).

- 3 Click on **[OK]** or **[Cancel]** to close the dialogue.

3.3.3.2 Carry out factory reset

- ✓ The required instrument file is marked.

- 1 Click on **[Test/analyze transmitter]**.

The **Properties of <Instrument type> <Serial number>** dialogue is opened with the **Test/analyze transmitter** register.

- 2 Mark **Transmitter test**.

Current operating hours are shown.

- 3 Confirm control query to perform the reset.

The values are reset to the default settings.

- 4 Click on **[OK]** or **[Cancel]** to close the dialogue.

3.3.3.3 Test analog output channel 1 / 2 / 3

✓ The desired instrument file is highlighted.

1 Click on **[Test/analyze transmitter]**.

The dialog **Properties of <Instrument type> <Serial number>** is opened with the tab **Test/analyze transmitter**.

2 Highlight channel and test value.

Field / button	Explanation
	Testing analog outputs (see <i>Volume 1, Chapter 1.4.6.5, Page 46</i>).

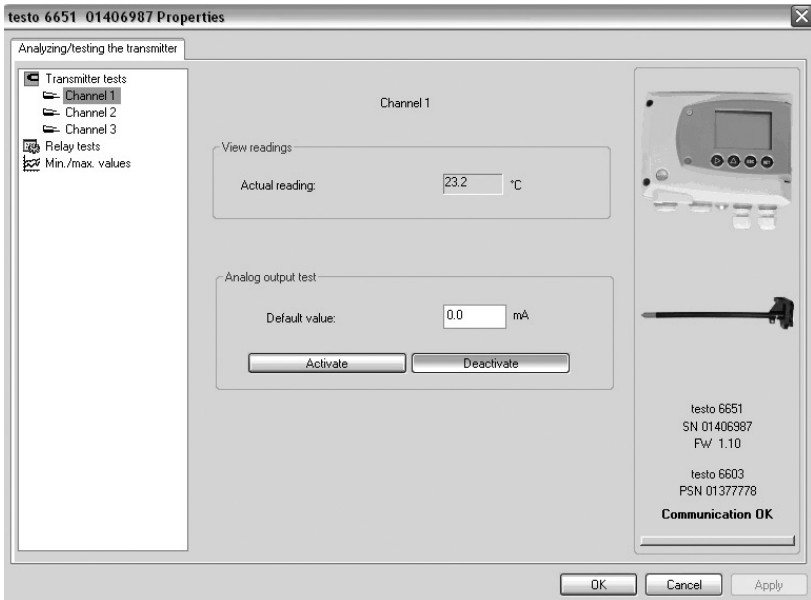

Current measurement value

Measurement value is refreshed every second

Unit

Unit according to the respective analog output type.

Pre-set value

Freely definable output value for the respective analog output type (V or mA), 1 decimal place.

Field / Button	Explanation
[Activate]	Clicking forwards the pre-set value entered to the respective analog output and to the test contacts. A warning indicates that if wired, the value will be transferred to the connected instruments . Now test the analog output using an accurate multimeter.
[Deactivate]	Ends connection of electrical parameter to analog output. The analog output returns to current measurement value .

- 3 To close the dialog, click on **[OK]** or **[Cancel]**.
The analog output returns to measurement mode.

3.3.3.4 Testing switch output relays 1 to 4

✓ The required instrument file is marked.

1 Click on [Test/analyze transmitter].

The **Properties of <Instrument type> <Serial number>** dialogue is opened with the **Test/analyze transmitter** register.

2 Mark **Relay tests** and test the values.

Field/button	Explanation
	Check the relay function (see <i>volume 1, chapter 1.4.6.6, page 48</i>).

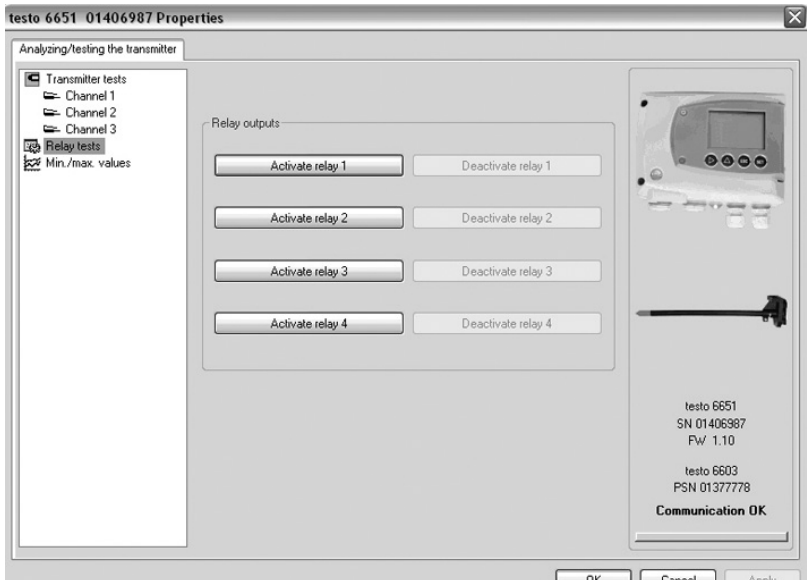

[Activate relay n] Close contact.
A warning informs that the value is being transmitted to a connected PLC, external display, etc. in the event of existing cabling.

[Deactivate relay n] Open contact.
A warning informs that the value is being transmitted to a connected PLC, external display, etc. in the event of existing cabling.

3 Click on [OK] or [Cancel] to close the dialogue.

The analog output returns to Measuring Mode again.

3.3.3.5 Displaying min./max. values

The transmitter saves the minimum or maximum value for each channel (measured since the last voltage supply or since the last manual reset).

✓ The required instrument file is marked.

1 Click on **[Test/analyze transmitter]**.

The **Properties of <Instrument type> <Serial number>** dialogue is opened with the **Test/analyze transmitter** register.

2 Mark **Min./max. values**.

Field/button	Explanation
	View the min./max. values of each channel.

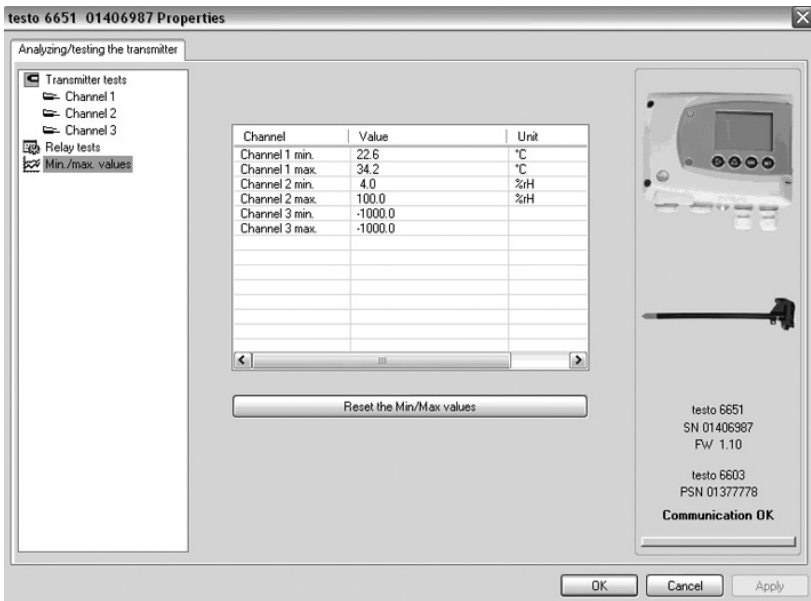

- Channel Min./max. of channel 1/2
- Value Min. or max. value, 1 decimal place.
- Unit Unit selected in **Unit/analog output**.

3 **Reset Min./max. values.**

- 4 Click on **[Reset the min./max. values]**.
- 5 Confirm control query to perform the reset.
The values are reset to the default settings.
- 5 Click on **[OK]** or **[Cancel]** to close the dialogue.

3.3.4 Adjusting the transmitter

This function is used to adjust an attached instrument. The following adjustments may be carried out using the software:

- 1-point adjustment (offset)
- 2-point adjustment (upper and lower adjustment point)
- Analog adjustment (entry via assistant/wizard).

Also see *volume 1, chapter 1.3.3, page 31, Adjusting the instrument for this.*

3.3.4.1 1-point adjustment



The testo 400/650 with precision humidity probe (order no. 0636 9741) is recommended as the reference measuring instrument for 1-point adjustment (offset) (see *volume 1, chapter 1.3.3.2, page 32*).

- 1 Expose the reference measuring instrument and the instrument to be adjusted to the same constant conditions and wait for equalization period to lapse.
- 2 Mark the instrument file of the connected instrument.
- 3 Click on **[Adjusting the transmitter]**.
The **Properties of <Instrument type> <Serial number>** dialogue is opened with the **Adjusting the transmitter** register.
- 4 Enter reference value and click on **[Carry out 1-point adjustment]**.
- 5 Confirm confirmation request.
The adjustment is carried out.

Field	Explanation
-------	-------------

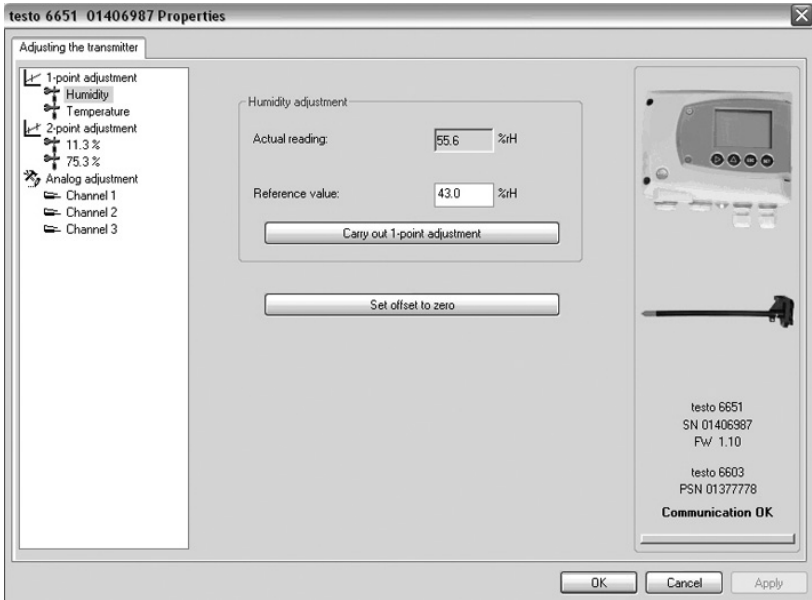

°C/°F

Selection of the unit; only for temperature adjustment.

Current reading

Reading in °C/°F or % RH.
Readings are updated every second.

Reference value

Entry of the read-off value from the reference measuring instrument.

Permissible entries:

- max. 5 % RH deviation (sum of all 1-point adjustments)
- max. 2 K (°C) deviation (sum of all 1-point adjustments)

- Click on **[Set offset to zero]** to reset a transmitted reference value.

The current reading is used again.

- 6 Click on **[OK]** or **[Cancel]** to close the dialogue.

3.3.4.2 2-point adjustment



Also see *volume 1, chapter 1.3.3.3, page 34.*

- 1 Expose the reference measuring instrument and the instrument to be adjusted to the same constant conditions and wait for equalization period to lapse.
- 2 Mark the instrument file of the connected instrument.
- 3 Click on **[Adjusting the transmitter]**.
The **Properties of <Instrument type> <Serial number>** dialogue is opened with the **Adjusting the transmitter** register.
- 4 Mark **11.3 %**, enter the reference value for the lower adjustment point and click on **[Lower adjustment point]**.
The adjustment is carried out.
- 5 Mark **75.3 %**, enter the reference value for the upper adjustment point and click on **[Upper adjustment point]**.
The adjustment is carried out.

Field	Explanation
-------	-------------

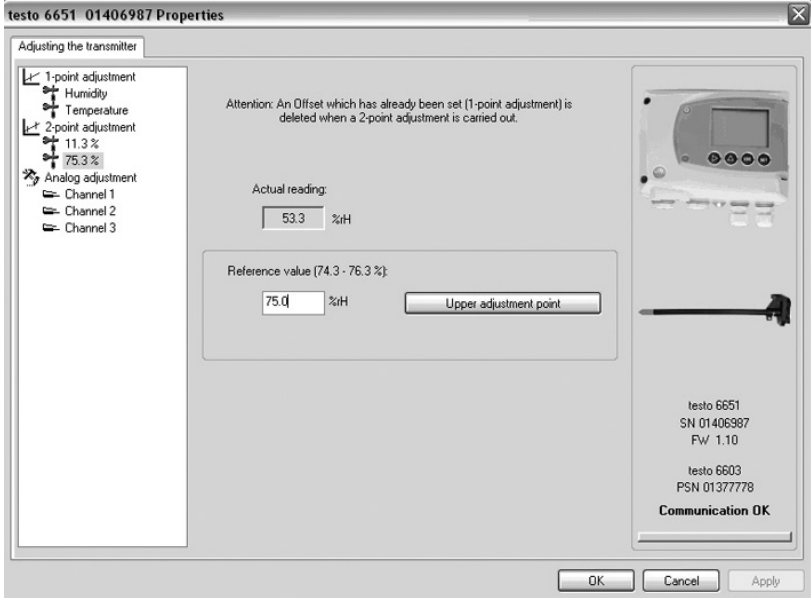

Current reading

Reading in % RH.
Readings are updated every second.

Reference value

Entry of the read-off value from the reference measuring instrument.

Permissible entries:

- Lower adjustment point 10.3 to 12.3 % RH
- Upper adjustment point 74.3 to 76.3 % RH.

6 Click on **[OK]** or **[Cancel]** to close the dialogue.

3.3.4.3 Adjusting the analog output

- 1 Connect precision multimeter (see *volume 1, chapter 1.3.3.4, page 36*).
- 2 Mark the instrument file of the connected instrument.
- 3 Click on **[Adjusting the transmitter]**.

The **Properties of <Instrument type> <Serial number>** dialogue is opened with the **Adjusting the transmitter** register.

- 4 Click on **[Start wizard...]** and follow the instructions of the wizard.
The adjustment is performed when the wizard is closed.

Field	Explanation
-------	-------------

Default value	<p>The analog output value is given at the output:</p> <ul style="list-style-type: none"> - Lower adjustment point: 10% of the max. value - Centre adjustment point: 50% of the max. value - Upper adjustment point: 90 % of the max. value.
---------------	-------------------------------------------------------------------------------------------------------------------------------------------------------------------------------------------------------------------------------------------------------------------------------

Measured analog value	<p>Required field: Entry of the value read off at the multimeter.</p>
-----------------------	---------------------------------------------------------------------------

3.3.5 Transmitter history

Parameterizations, adjustment processes and messages that have occurred are registered in the transmitter with an operating hours stamp.

In the history overviews (explained later in more detail), past processes and events can be made visible.



For parameter changes or adjustments that are performed directly at the instrument (via the user menu), "Transmitter" is entered in the **User** field and only the operating hour is entered in the **Date/time** field instead of operating hour/date/time.

For entries that are performed using the P2A software, the name of the user logged into Windows appears in the **User** field, while the operating hour is shown in the **Date/time** field.

- 1 Mark the instrument file of the connected instrument.
- 2 Click on [**Transmitter history**] button.
The "**Properties of <Instrument type> <Serial number>**" dialogue is opened with the **Transmitter history** register.
- 3 Click on the required entry in the list to change the display.

Parameterization history Explanation

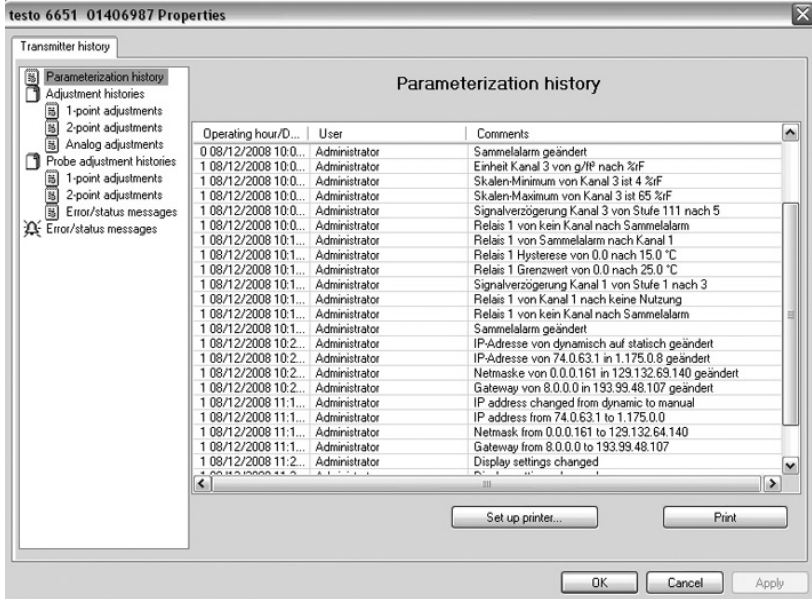

Date/time Format of the PC time is adopted from the settings of the operating system.

User Name with which the user is logged into the operating system.
 "MUF" (= transmitter) if the change was performed at the instrument.

Operating hours/date/time Operating hour/time stamp at which the change at the instrument was performed.

Comments Type of parameter change, e.g. "Unit of channel 2 from °F to °C".

Adjustment histories **Explanation**

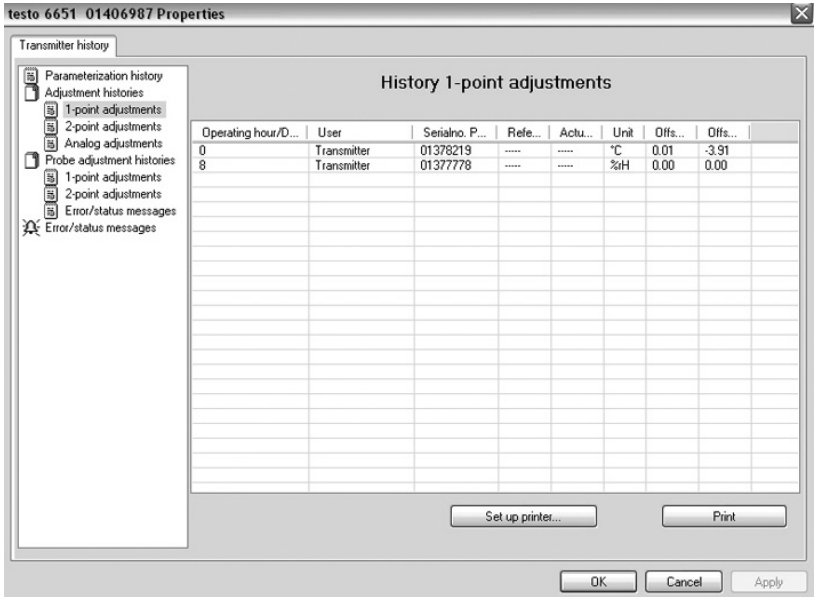

Selection: 1-point adjustments/2-point adjustments/Analog adjustments.

Date/time Format of the PC time is adopted from the settings of the operating system.

User Name with which the user is logged into the operating system.
 "MUF" (= transmitter) if the change was performed at the instrument.

Operating hours/date/time Operating hour/time stamp at which the change at the instrument was performed.

Serial no. probe Serial number of the probe.

Reference value If no changes were performed, no value is displayed.

Unit	Unit during the adjustment.
Column	Explanation
Actual value before adjustment	1-point adjustment: If no changes were performed, no value is displayed.
Offset from	1-point adjustment: Value before the adjustment.
Offset to	1-point adjustment: Value after the adjustment.
Offset	2-point adjustment: Difference between target and actual value reported by instrument.
Channel	Analog adjustment: Channel 1 to n.
Specification	Analog adjustment: Actual value.
Reading	Analog adjustment: Reference value entered.
Offset	Analog adjustment: Deviation at time of adjustment.

Error/status messages **Explanation**

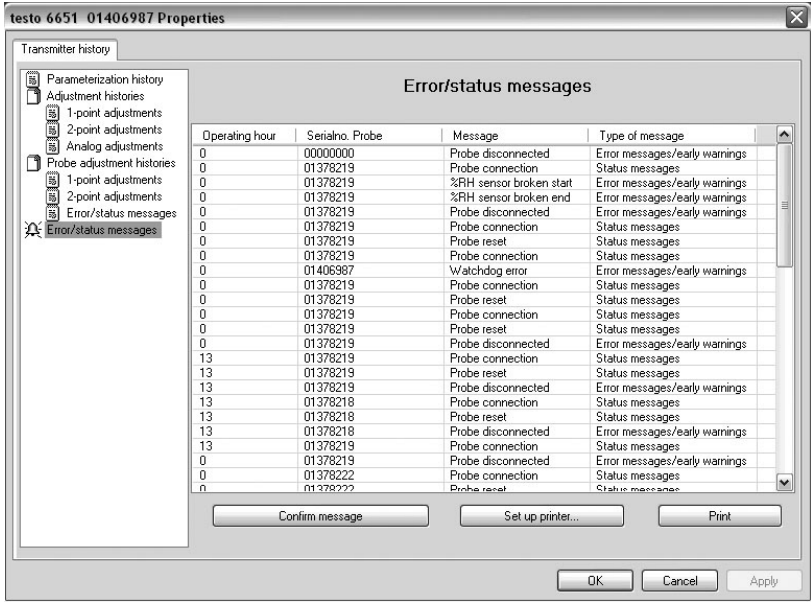

The table is shown only for error and status messages that were generated in the transmitter and have been saved.

Date/time Format of the PC time is adopted from the settings of the operating system.

Operating hours Operating hour at which the message appeared in the instrument.

User "MUF" (= transmitter) because the message was generated in the transmitter.

Message e.g. "Wrong probe". A non-compatible probe was connected.

Type of message e.g. early warning, status message.

- To print out the history data, click on **[Print]**.



The printing job is automatically sent to the default printer for the operating system.

The printout can be edited using **[Set up printer...]**.

This button is not working; the print command offers no selection of the printer.

- 4 Click on **[OK]** or **[Cancel]** to close the dialogue.

4 Tips and assistance

4.1 Questions and answers

Question	Possible causes/solutions
Connection to instrument cannot be established	Check connection cable/plug contacts
A message appears on the display	See <i>volume 1, chapter 1.5, page 53</i>
Malfunction (with or without display)	Analysis using the P2A software (see <i>chapter 3, page 89</i>).
Undo adjustment	<p>A 1-point temperature/humidity adjustment can be reset to the current reading using [Set offset to zero].</p> <p>The actual values before the adjustment can be read out from the corresponding history table.</p> <p>2-point adjustments and analog adjustments can only be undone -by means of a factory reset.</p>
When does a stable current reading appear?	After approx. 20 seconds

If we could not answer your question, please contact your dealer or Testo Customer Service. For contact data, see back of this document or web page www.testo.com/service-contact

4.2 Accessories and spare parts



An overview of the probes that can be used with the testo 6651 can be found in *volume 1, chapter 1.2.2, page 11*.

Designation	Article no.
Interface and software	
P2A software (parameterizing, adjusting, analyzing) incl. USB adapter	0554 6020
testo 400/650 adapter	0554 6022
Fastenings, assembly aids	
Wall/duct bracket with M3 screw for fastening the transmitter to the probe and the probe to the wall/duct	0554 6651
Single-hole plastic duct screw connection	0554 1793
Duct screw connection (aluminium/PVC)	0554 1794
Pressure-tight G 1/2" screw connection with cutting ring up to 16 bar	0554 1795
Pressure-tight G 1/2" screw connection with PTFE ring up to 6 bar	0554 1796
Plug-in connections	
Set of M12 plug-in connections (connector and socket) for power and signal lines	0554 6682
Sensor filters and protective caps	
PTFE protective cap	0554 9913
Stainless steel sintered filter	0554 0647
Wire mesh filter	0554 0757
Sintered PTFE filter	0554 0759
Protection cap made of metal (open)	0554 0755
Plastic protection cap (open)	0192 0265
Condensation protection	0554 0166
Adjustment equipment	
Salt pots (11.3/75.3 % RH adjustment set)	0554 0660
Reference set (testo 650, 1 % RH probe with certificate)	0699 3556/20
Adjustment adapter (for 1-point adjustment with testo 400 or testo 650)	0554 6022

Designation	Article no.
Ethernet	
Ethernet module for installation by customer	0554 6656
Ethernet plug	0554 6653
Supply	
Mains unit (desktop, wall-mounted)	0554 1748
Mains unit (top-hat rail mounting)	0554 1749
External display	
Prozess display testo 54-2 AC....	5400 7553
Prozess display testo 54-7 AC....	5400 7555
Calibration	
Standard ISO calibration certificate, transmitter only	0520 1000
Standard DAkkS calibration certificate, transmitter only	0520 1200
Standard ISO calibration certificate, transmitter + probes	0520 0176
Special ISO calibration certificate, transmitter + probes	0520 0066
Standard DAkkS calibration certificate, transmitter + probes	0520 0276
Special DAkkS calibration certificate, transmitter + probes	0520 0236
DAkkS calibration certificate temperature, probes	0520 0261

4.2.1 Ordering options for testo 6651 transmitter (0555 6651)

Order code	Characteristic
Axx Version	
A01	0555 6651
Bxx Analog output	
B01	4 to 20 mA (2-wire, 24 VDC) (not with relay or Ethernet module) ¹
B02	0 to 1 V (4-wire, 24 VAC/DC)
B03	0 to 5 V (4-wire, 24 VAC/DC)
B04	0 to 10 V (4-wire, 24 VAC/DC)
B05	0 to 20 mA (4-wire, 24 VAC/DC)
B06	4 to 20 mA (4-wire, 24 VAC/DC)
Cxx Display	
C00	without display
C02	with display/English
C03	with display/German
C04	with display/French
C05	with display/Spanish
C06	with display/Italian
C07	with display/Japanese
Dxx Cable entry	
D01	M16 PG screw connection (with relay, also M20)
D02	Cable entry NPT 1/2"
D03	Plug-in connections for power and signal lines
Exx Ethernet module	
E00	without Ethernet module
E01	with Ethernet module
Fxx Channel 1 Unit	
F01	% RH/Min/Max

¹ In this option, the display illumination cannot be switched on

Order code	Characteristic
F02	°C/Min/Max
F03	°F/Min/Max
F04	°Ctd/Min/Max
F05	°Ftd/Min/Max
Gxx	
Channel 2 Unit	
G01	% RH/Min/Max
G02	°C/Min/Max
G03	°F/Min/Max
G04	°Ctd/Min/Max
G05	°Ftd/Min/Max
Hxx Relay	
H00	without relay
H01	4 relay outputs, limit value monitoring
H02	4 relay outputs, channel 1 limit values and collective alarm

4.2.2 Ordering options for testo 6600 probes (0555 6600)

Order code	Characteristic
Lxx Probe type	
L 01	Probe 6601
L 02	Probe 6602
L 03	Probe 6603
L 04	Probe 6604
L 05	Probe 6605
Mxx Protective filter	
M 01	Stainless steel sintered filter
M 02	Metal wire protection cap
M 03	Sintered PTFE filter
M 04	Open metal protection cap
M 05	ABS plastic cap (open)
Nxx Cable length	
N 00	Without cable (testo 6601)
N 01	1 m cable length (testo 6604, 6605)
N 02	2 m cable length (testo 6604, 6605)
N 05	5 m cable length (testo 6605)
N 23	Cable length specifically for duct versions (testo 6602, 6603)
Pxx Probe length	
P 07	Probe length approx. 70 mm (testo 6601)
P 14	Probe length approx. 140 mm (testo 6604)
P 20	Probe length approx. 200 mm (testo 6601, 6605)
P 28	Probe length approx. 280 mm (testo 6602, 6603, 6604)
P 50	Probe length approx. 500 mm (testo 6605)



testo AG

Postfach 1140, 79849 Lenzkirch
Testo-Strasse 1, 79853 Lenzkirch
GERMANY

Phone: +49 (0) 7653 681-0

Fax: +49 (0) 7653 681-100

Internet: www.testo.com

email : info@testo.com
