



testo 6740

Instruction manual

en





# Preface

## **Preface**

Dear Testo Customer

Congratulations for choosing a Testo product. We hope that you will enjoy many years of using the product and that it will help you in your work.

If problems should occur which you cannot rectify yourself, please consult our service department or your dealer. We will endeavour to provide fast and competent assistance to save you long periods out of operation.

## General information

This Instruction manual contains important information about the features and use of the product. Please read this document through carefully and familiarise yourself with the operation of the product before putting it to use. Keep the Instruction manual to hand so that you can refer to it when necessary.

### Pictograms

This product could be dangerous if operated incorrectly. Information that requires particular attention is identified in this Instruction manual by pictograms:

Warnings are identified by means of a warning triangle. The relevant **signal word!** indicates the degree of risk:



**Warning!** means: Serious physical injury could occur if you do not take the precautionary measures indicated.

**Caution!** means: Slight physical injury or material damage could occur if you do not take the precautionary measures indicated.

### Signal word!

Pay particular attention to warnings and take the precautionary measures indicated in order to avoid danger.

**!** Notes on special cases and peculiarities in the handling of the product are indicated by an exclamation mark.

### Standards/Approvals



According to the conformity certificate, this product fulfills all 2004/108/EEC guidelines.



# Contents

Preface.....	2
General information .....	3
Contents.....	4
1. Basic safety information .....	5
2. Intended use .....	6
3. Product description .....	7
3.1 System components .....	7
3.2 Operating elements .....	7
3.3 Settings .....	8
3.4 Current output intervals .....	8
4. Initial operation .....	9
4.1 Mechanical assembly .....	9
4.2 Electric connection .....	11
4.3 Analog output/Limit signal outputs .....	14
5. Menu guide (0555.6743/0555.6744 only) .....	16
6. Adjustment on site .....	19
7. Care and maintenance .....	23
8. Troubleshooting .....	24
9. Technical data .....	25
9.1 Measurement ranges and accuracies .....	25
9.2 Additional instrument data .....	25
9.3 Uncertainty pressure dewpoint temperature.....	26
10. Accessories/Spare parts .....	27

# 1. Basic safety information

## **Avoid electrical hazards:**

- ▶ Never take measurements with the instrument and its probes on or near live components unless the instrument is expressly approved for current and voltage measurements.

## **Protect the instrument:**

- ▶ Never store the unit together with solvents (e.g. acetone).

## **Preserving product safety/warranty entitlement:**

- ▶ Operate the instrument only within the parameters specified in the Technical data.
- ▶ Handle the instrument appropriately and according to its intended purpose.
- ▶ Never apply force!
- ▶ Temperature data on sensors/probes refer only to the measurement range of the sensors. Do not subject handles and lines to temperatures greater than 70°C if they are not expressly approved for higher temperatures.
- ▶ Open the instrument for maintenance and repair purposes only if specifically described in the Instruction Manual.
- ▶ Maintenance work should only be carried out if described in the Instruction Manual. Please adhere to the steps described. For safety reasons, please only use spare parts from Testo.

Any additional work should only be carried out by authorised trained personnel. Otherwise Testo does not accept responsibility for the functioning of the instrument following maintenance and for the validity of approvals.

## **Dispose of carefully:**

- ▶ Once its service life has come to an end, return the instrument to us and we will dispose of it.



## 2. Intended use

**The instrument is intended for use in the following applications:**

The testo 6740 instrument is a pressure dew point transmitter for measuring trace humidity. It is used in the following areas:

- Monitoring trace humidity in compressed air systems and gas networks (e.g. pipeline and container drying).
- Controlling and monitoring (compressed air) driers.
- Monitoring compressed air humidity in vehicles.
- Monitoring humidity and temperature in medical compressed air or granulate driers.



**Warning!**

Application in hazardous areas is not allowed!

---

## 3. Product description

### 3.1 System components

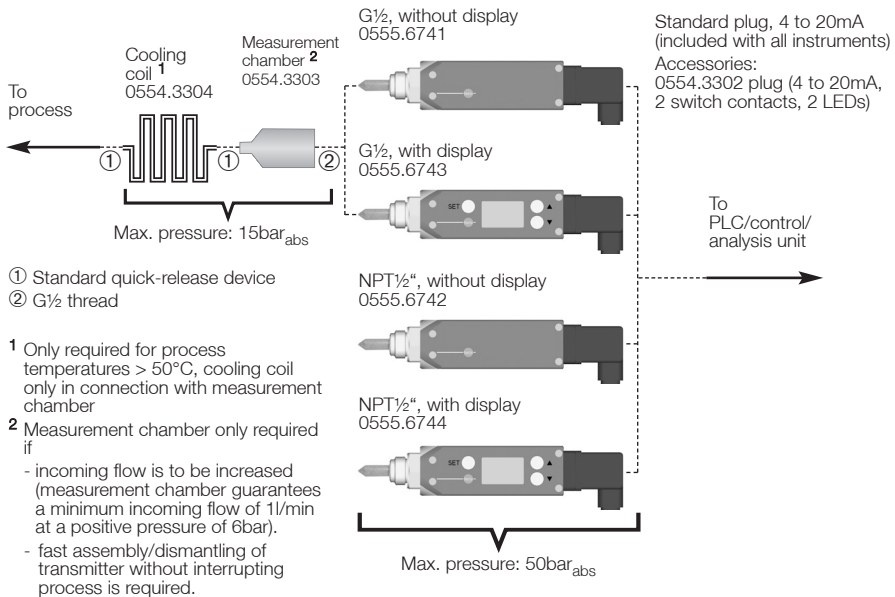

### 3.2 Operating elements

The instruments with the article numbers 0555.6741 and 0555.6742 do not have any additional operating elements.

The instruments with the article numbers 0555.6743 and 0555.6744 have a keypad and a display to input and read off settings (See 5. Menu guide, p. 16).

All of the instruments of Type testo 6740 can be parameterised with the aid of the 0554.3305 scaling adapter.

### 3.3 Settings

The parameters in the instrument are assigned the following values in the factory (default values):

Parameter	Pressure dew point <sup>1</sup>		Atmospheric dew point <sup>1</sup>		Relative humidity	Temperature		Absolute humidity	
	°Ctp	°Ftp	°CtA	°FtA		°C	°F	ppm <sub>v</sub>	mg/m <sup>3</sup> (Abs)
4mA	-60	-75	-60	-75	0	0	32	0	0
20mA	30	85	30	85	100	50	120	30000 <sup>2</sup>	30000 <sup>2</sup>
LS	4	40	4	40	30	10	50	8400	7000
US	10	55	10	55	50	30	85	13000	9600
Hyst	2	2	2	2	2	2	2	2	2

<sup>1</sup> With dew point temperatures <0°Ctp/ <0°CtA/ <32°Ftp/ <32°FtA the frostpoint temperature (dewpoint upon ice) is displayed

<sup>2</sup> Display is shown to the power of ten: 30E3 (corresponds to 30 x 10<sup>3</sup> = 30 x 1000 = 30000)

### 3.4 Current output intervals

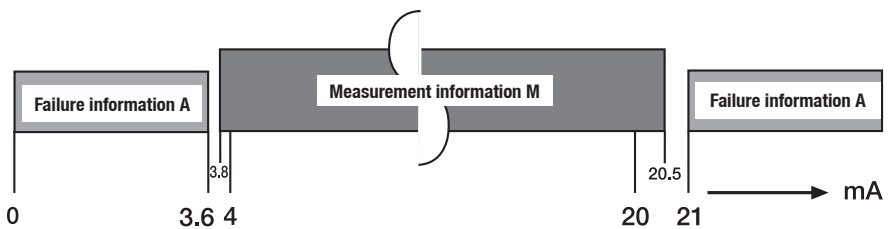



## 4. Initial operation

### 4.1 Mechanical assembly

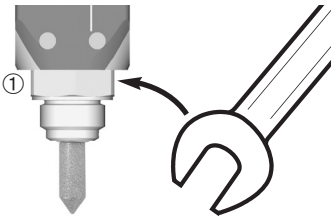

We recommend you wrap the thread of the process connection in sealing tape (e.g. PTFE) or place it in a copper gasket (inner diameter: 21mm).

► Force should only be applied to the Allen screw ①.

There are 3 different options for assembly depending on the application:

Assembly	Application
Without measurement chamber and cooling coil	<ul style="list-style-type: none"> <li>- Process temperatures 0 to 50°C</li> <li>- It is possible to attach sensor directly in process</li> <li>- No quick assembly/dismantling of testo 6740 required and flow on sensor is sufficient (1l/min)</li> </ul>
With measurement chamber	<ul style="list-style-type: none"> <li>- Process temperatures 0 to 50°C</li> <li>- Fast assembly/dismantling of testo 6740 required and/or flow on sensor is insufficient (1l/min)</li> </ul>
With measurement chamber and cooling coil	<ul style="list-style-type: none"> <li>- Process temperatures 50 to 200°C</li> </ul>

#### Without measurement chamber and cooling coil



**Warning**

Compressed air!

**Risk of injury!**

► Depressurise pipe sections (e.g. compressor off or use bypass) and aerate before opening.

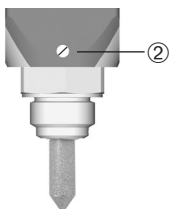

1 Screw process connection (G $\frac{1}{2}$  or NPT $\frac{1}{2}$ " ) into the matching thread.

The housing can be rotated by 350°. Do not use force when aligning.

2 Set up housing so that the display can be easily read. Tighten grub screw ②.

3 Complete aeration of pipe section and apply pressure to pipe section.

**With measurement chamber (max. 15bar)**

- 1 Connect measurement chamber without measurement transmitter to the compressed air push-in quick connection for approx. 10 - 30 s, in order to blow out any dirt deposits
- 2 Remove measurement chamber from compressed air push-in quick connection.
- 3 Screw in process connection (G $\frac{1}{2}$ ) of the testo 6741/6743 transmitter in measurement chamber thread.
- 4 Snap push-in quick connection of measurement chamber in standard socket of compressed air line.

**With measurement chamber and cooling coil (max. 15bar)**

- 1 Connect measurement chamber without measurement transmitter to the compressed air push-in quick connection for approx. 10 - 30 s, in order to blow out any dirt deposits
- 2 Remove measurement chamber from compressed air push-in quick connection.
- 3 Screw in process connection (G $\frac{1}{2}$ ) of testo 6741 / 6743 transmitter into thread of measurement chamber.
- 4 Snap push-in quick connection of measurement chamber in push-in quick connection of the cooling coil.
- 5 Snap second push-in quick connection of the cooling coil into the standard socket of the compressed air line.

## 4.2 Electric connection

### Standard plug

We recommend an 8 wire cable with a tightly braided screen and a core cross-section of 0.2 to 0.5mm<sup>2</sup>.

- 1 Loosen and remove ① screw at the back of the plug and remove plug from transmitter ②.
- 2 Remove plug socket from the plug housing. To do this apply a small screwdriver to the point marked with "lift" and press out carefully ③.
- 3 Screw on the cable positioning device ④ and guide the cables through the plug housing ⑤.
- 4 Connect cable ends to the screw terminals of the plug socket ⑥:

#### Plug socket terminals

- |    |                                  |
|----|----------------------------------|
| 1: | + (4 to 20mA), power: 12...30VDC |
| 2: | - (4 to 20mA)                    |
| 3: | Not assigned                     |
| 4: | Measuring earth (cable screen)   |

- 5 Insert plug socket into plug housing again until it snaps into place ⑦ and screw on cable fixing unit.
- 6 Attach plug to transmitter ⑧ and secure with screw ⑨.

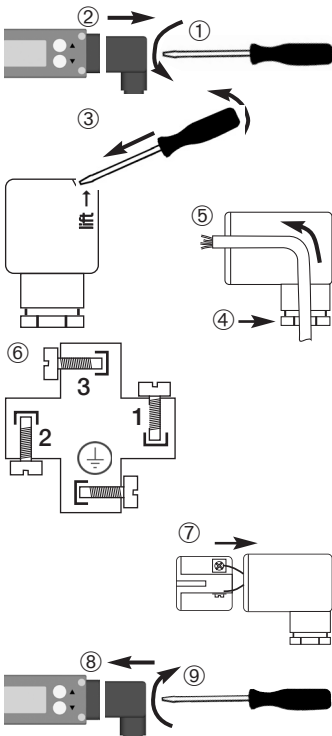

### 0554.3302 plug (with 2 switch outputs)

We recommend an 8 wire cable with a tightly braided screen, wire cross-section 0.2 to 0.8mm<sup>2</sup>.

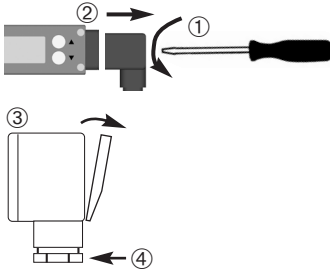

- 1 Loosen and remove screw ① at the back of the plug and remove plug from transmitter ②.
- 2 Tilt the cover of the plug housing at an angle and remove ③.
- 3 Remove plug socket from the front and the relay board from the back out of the plug housing.
- 4 Screw on cable positioning device ④ and guide cables through the plug housing.
- 5 Connect cable ends to the screw terminals of the relay board or the plug socket ⑤:

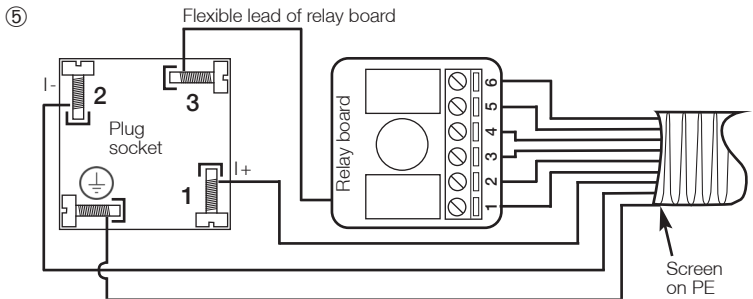

The supply lines need to be galvanically connected, so connect either (A) - (A) or (B) - (B)!

#### Plug socket terminals

1: I+ (4 to 20mA)	(A)	} Current signal and supply 20 to 28VDC
2: I- (4 to 20mA)	(B)	
3: (connected to relay board in factory)		
⊥: Put on screen		

#### Relay board terminals

1: 20 to 28VDC	(A)
2: LS+	
3: LS-	
4: US+	
5: US-	
6: 0VDC	(B)

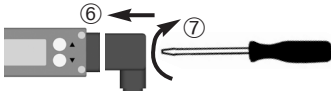

- 6 Push plug socket and plug board into the plug housing (pay attention to alignment) and close lid.
- 7 Screw on cable positioning device.
- 8 Attach plug to transmitter ⑥ and screw into place ⑦.

## 4.3 Analog output/ Limit signal outputs

### Standard plug/0554.3302 plug

Both plug variations have a 4 to 20mA analog output available in two-wire technology.

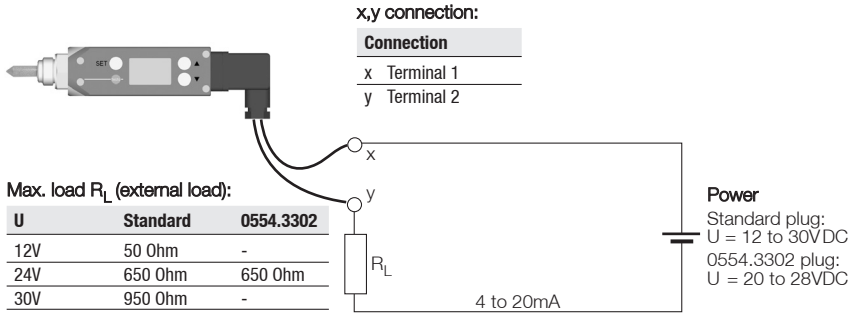

### Limit signal outputs with 0554.3302 plug

Two floating contacts (NO contact) are available.

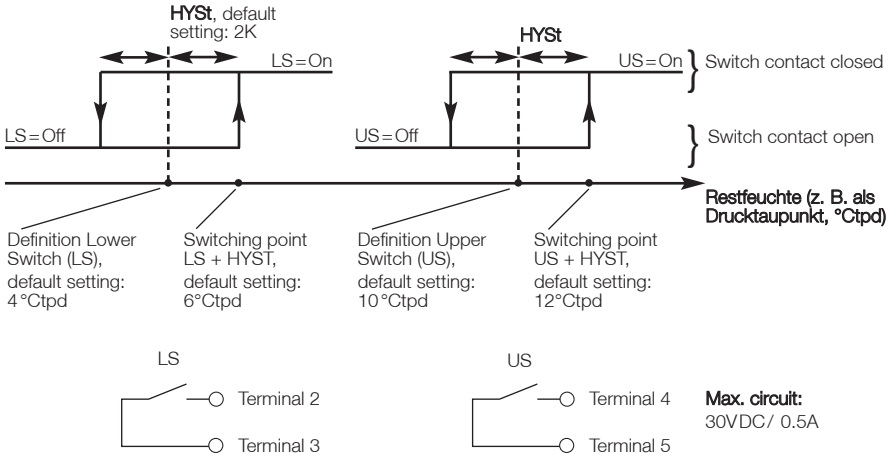

Default settings for other parameters (ppm, %RH, ...)  
See 3.3 Settings, p.8

#### Example:

- The lower alarm shall be switched at +8 °Ctpd
- The higher alarm shall be switched at +12 °Ctpd

Set these values

- LS = 6 °Ctpd
- US = 10 °Ctpd
- Hyst = 2 °C
- Switching point lower alarm = LS + Hyst = 8 °Ctpd
- Switching point upper alarm = US + Hyst = 12 °Ctpd

# 5. Menu guide (0555.6743/0555.6744 only)

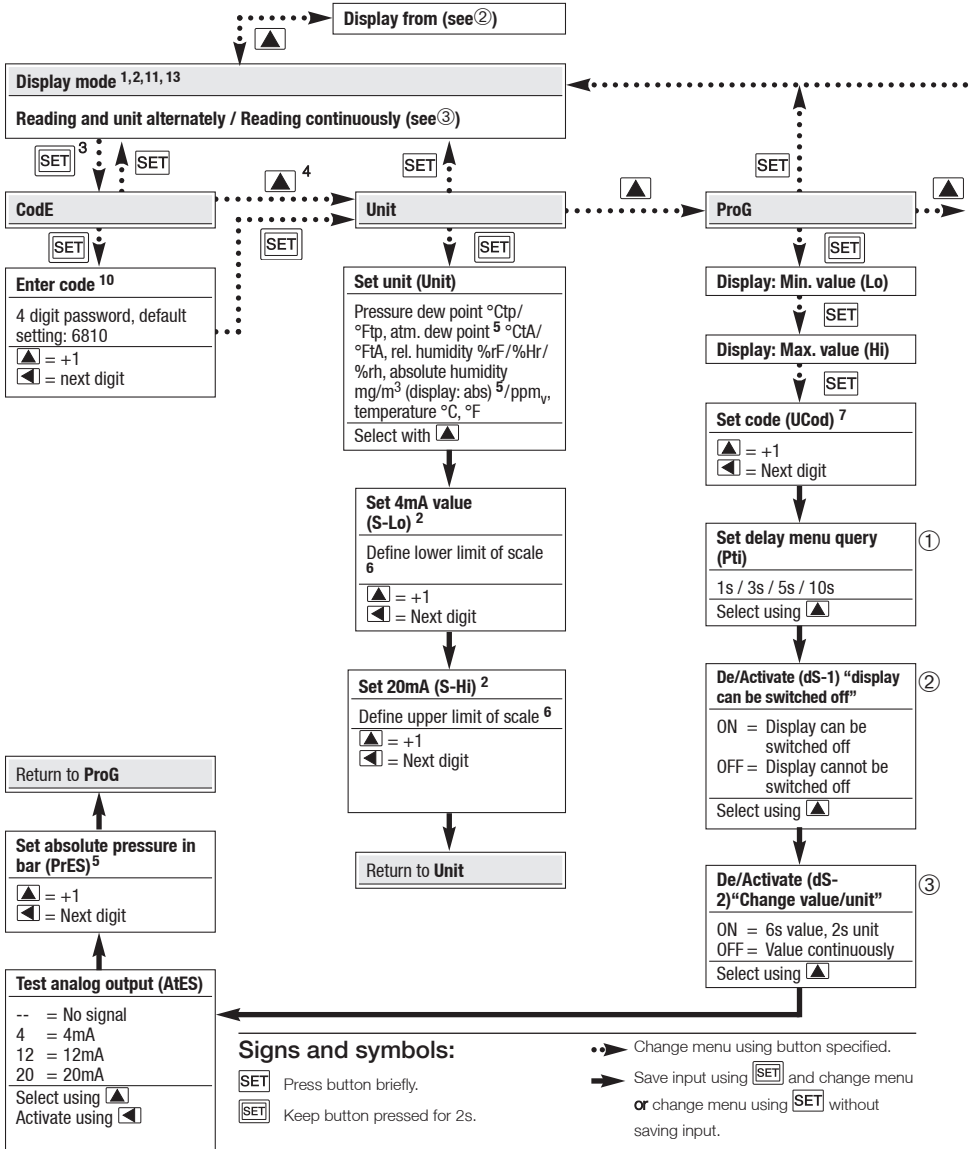



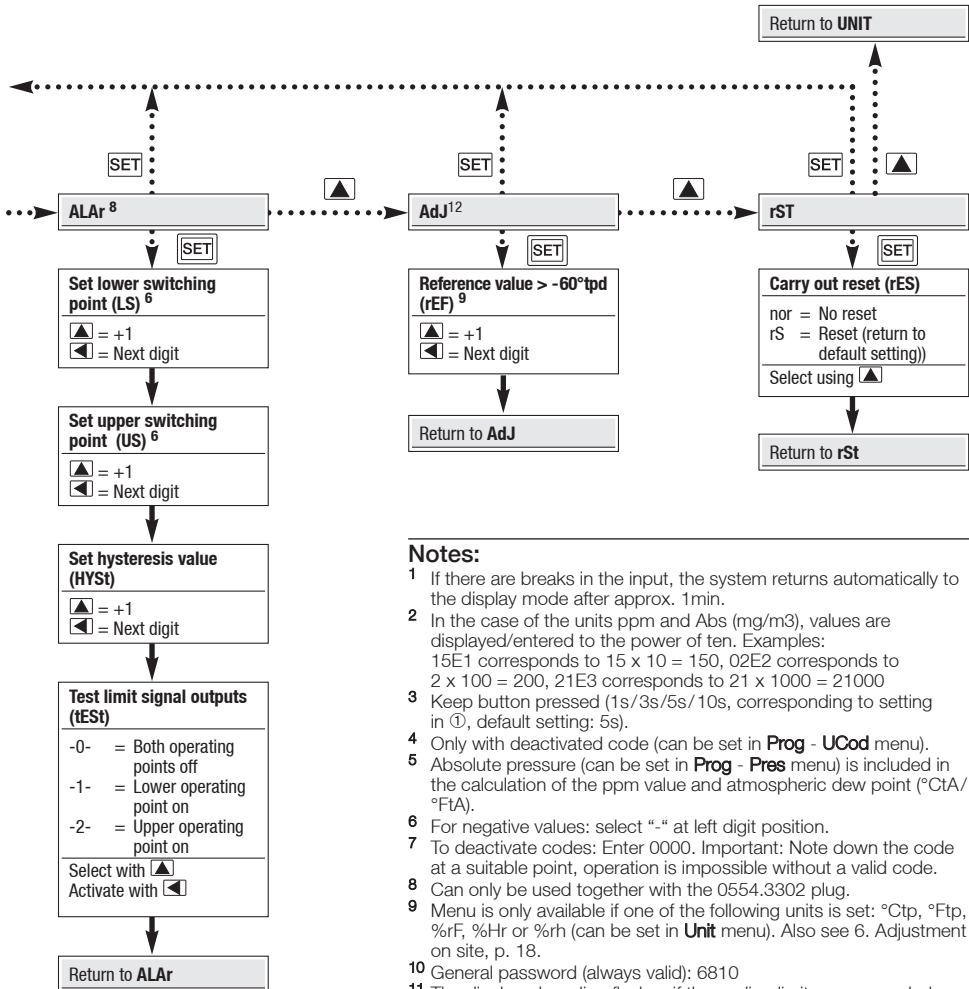

### Notes:

- <sup>1</sup> If there are breaks in the input, the system returns automatically to the display mode after approx. 1min.
- <sup>2</sup> In the case of the units ppm and Abs (mg/m<sup>3</sup>), values are displayed/entered to the power of ten. Examples:  
15E1 corresponds to 15 x 10 = 150, 02E2 corresponds to 2 x 100 = 200, 21E3 corresponds to 21 x 1000 = 21000
- <sup>3</sup> Keep button pressed (1s/3s/5s/10s, corresponding to setting in ①, default setting: 5s).
- <sup>4</sup> Only with deactivated code (can be set in **Prog - UCod** menu).
- <sup>5</sup> Absolute pressure (can be set in **Prog - Pres** menu) is included in the calculation of the ppm value and atmospheric dew point (°CtA/°FtA).
- <sup>6</sup> For negative values: select “-” at left digit position.
- <sup>7</sup> To deactivate codes: Enter 0000. Important: Note down the code at a suitable point, operation is impossible without a valid code.
- <sup>8</sup> Can only be used together with the 0554.3302 plug.
- <sup>9</sup> Menu is only available if one of the following units is set: °Ctp, °Ftp, %rF, %Hr or %rh (can be set in **Unit** menu). Also see 6. Adjustment on site, p. 18.
- <sup>10</sup> General password (always valid): 6810
- <sup>11</sup> The displayed reading flashes if the scaling limits are exceeded (can be set in Menu **UNIT - S-Lo** or **S-Hi**).
- <sup>12</sup> Compare chapter 6.
- <sup>13</sup> Display blinks if actual values are below 4mA setting or above 20mA setting.

### ( 0555.6743 only) supplement

available from version June 2007 on. For older versions an update of the firmware is necessary

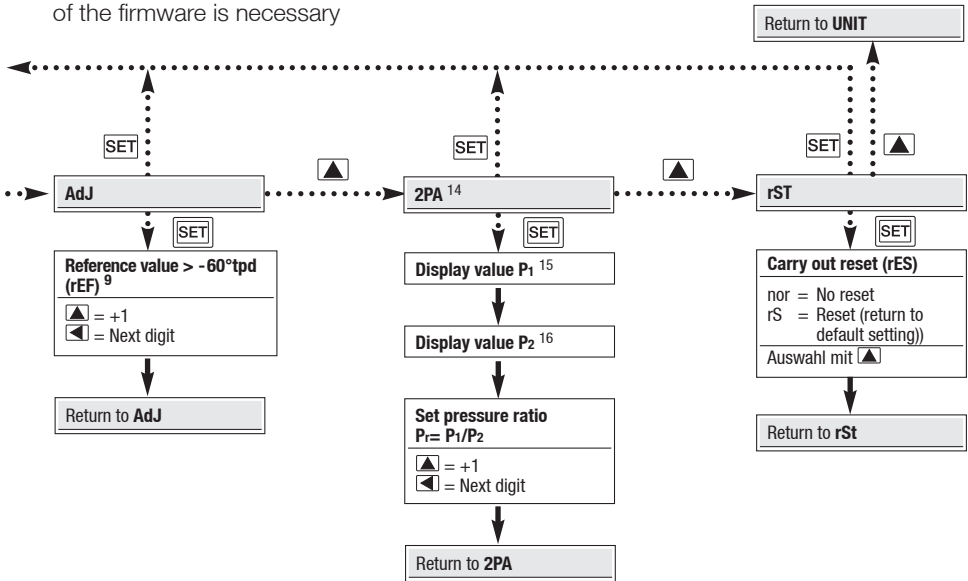

#### Comments:

- <sup>14</sup> Can only be used in combination with a 2-point adjustment (cf. chap 6.2)
- <sup>15</sup> In this setting point, **P1** and the relative humidity at the pressure level **P1** are alternately displayed. Please wait until the relative humidity has a constant value, and only then press the SET button.
- <sup>16</sup> In this setting point, **P2** and the relative humidity at the pressure level **P2** are alternately displayed. Switch the switchover cock of the adjustment device and then wait until the relative humidity has a constant value, and only then press the SET button.

## 6. Adjustment on site

### One point adjustment by inputting one reference value

Using one point adjustment, you can enter a reference value for a working point (e.g.  $-40^{\circ}\text{C tpd}$ ) specified by you. In this way you will achieve a minimum target/actual deviation from this working point.

A dew point mirror is ideal as a reference measuring instrument.

**!** The **Adj** menu in which the reference value is entered is only available if one of the following units is set:  $^{\circ}\text{Ctp}$ ,  $^{\circ}\text{Ftp}$ , %rF, %Hr or %rh (See 5. Menu guide, p. 16, **Unit** menu, Setting **unit**).

### Reference value input

Optimum precision is achieved at reference value  $-40^{\circ}\text{C tpd}$ . In case low dewpoints ( $<-25^{\circ}\text{C tpd}$ ) are relevant, it is suggested to avoid reference values  $>-30^{\circ}\text{C tpd}$  (else loss of precision).

- 1 Expose reference measuring instrument and testo 6740 to identical, constant conditions and await adjustment time.
- 2 Measure reference value and compare with testo 6740 reading.
- 3 If there are deviations in the values, enter reference value in **Adj** menu.

### Two-point adjustment for testo 6743

available from version June 2007 on. For older versions an update of the firmware is necessary (please address Testo service)

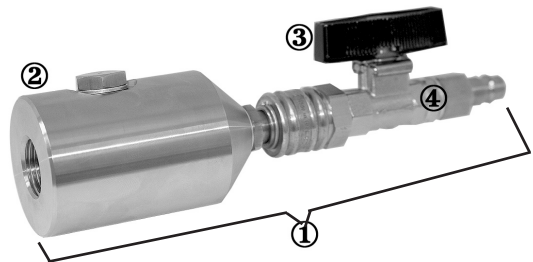

- ① 2-pressure adjustment device (0554 3314)
- ② Adjustment chamber
- ③ Switchover cock
- ④ Sintered filter

A two-point adjustment can be carried out with the testo 6743 and the 2-pressure adjustment device (①). The two-point adjustment serves to adjust the testo 6743 to trace humidity. A reference instrument or humidity generator is not necessary. Depending on the position of the switchover cock (③) of the 2-pressure adjustment device (①), the sensor of the testo 6743 is exposed to two different pressure levels.

- ❗ In front of the switchover cock (③) of the 2-pressure adjustment device (①) is a sintered filter (④) which prevents dirt particles, rust and oil from entering the adjustment chamber (②).
- ❗ The 2-pressure adjustment device (①) must be under an absolute pressure of min. 3 bar and max. 16 bar.
- ❗ The calibration certificate of the 2-pressure adjustment device is obligatorily required for the pressure relationship P1/P2.



### Installation

- 1 Screw instrument testo 6743 (G1/2" process connection) into the adjustment chamber (②).
- 2 Connect 2-pressure adjustment device (①) to the compressed air pipe with the compressed air fast coupling (diameter 7.2).

! The permitted operating pressure is 3-16 bar.

### Adjustment

- 1 Read off process pressure/system pressure **P1**, e. g. from a manometer, and note value.

! The manometer should be installed close to the measurement site.

! Take the pressure relationship P1/P2 from the calibration certificate (page 2) based on the process pressure. Linear interpolation (calculation) is possible between the two values.

- 2 Open menu **2PA** (see chapter 5 "Menu guide"). **P1** and the relative humidity **%rF** at the pressure level **P1** are alternately displayed.

! The measuring instrument testo 6743 requires stable pressure values for the two-pressure-adjustment.

- 3 Wait until the value is constant and then press the SET button (see chapter 5 "Menu guide").

**P2** and the relative humidity **%rF** at the pressure level **P2** are alternately displayed. **P2** stands for the pressure in the adjustment chamber (②) when the switchover cock is closed (③).

- 4 Close valve (position switchover cock (③) across the measurement chamber (③) and wait until the relative humidity displayed has a constant value.

- 5 When the value is constant, confirm with the SET button (see chapter 5 "Menu guide").



## 22 6. Adjustment on site

- 6 Take the pressure relationship  $P1/P2$  from the calibration certificate (page 2) based on the process pressure. Linear interpolation (calculation) is possible between the two values..
- 7 Input the pressure ratio  $P_r = \frac{P_1}{P_2}$  into the operating menu. Confirm input with the SET button.
- 8 Remove adjustment device (①) from the compressed air pipe.
- 9 Unscrew testo 6743 from the adjustment chamber (②) and re-install for continuous operation.

### Limits of the adjustment chamber

In order to avoid false adjustments, the adjustment described above is only accepted by testo 6743 if

- a) The temperature during the adjustment process remains constant, i. e. the temperature difference is less than 0.5 Kelvin:  $(|T_1 - T_2| < 0.5 \text{ K})$ .

or

- b) The calculated offset correction is  $< |0.5\%RH|$  or  $< |0.1 * RHP1|$ . The greater condition applies! RHP1 is the relative humidity at pressure level P1.

Otherwise the display will show ERR.

## 7. Care and Maintenance

### Filter, measurement chamber, cooling coil

If process conditions are oily or dusty, the stainless steel sintered filter should be cleaned and also the measurement chamber and cooling coil should be cleaned if used.

- ▶ Unscrew/remove filter, measurement chamber and cooling coil, purge with compressed air or place in an ultrasonic bath.

### Sensor cleaning

- ! During cleaning, avoid touching the sensor at all costs.
- ! Do not clean the sensor mechanically, as this can damage the cover electrode.
- ▶ Screw off filter cover.
- ▶ Carefully rinse the sensor with isopropyl alcohol and/or distilled water.
- ▶ Allow the sensor to dry completely

### Cleaning the adjustment chamber

The sintered filter integrated into the adjustment device should be blasted clean with compressed air at regular intervals, depending on the degree of contamination.

- ▶ Unscrew the sintered filter from the adjustment device and blast clean against the flow-through direction.

! After blasting clean, pay attention that the sintered filter is installed in flow-through direction (observe the arrow on the adjustment device, which shows the flow-through direction).

! For oily media, the sintered filter, and possibly also the adjustment device, should be cleaned in an ultrasound bath.

! After long periods of high humidity, the switchover cock must be opened for drying.

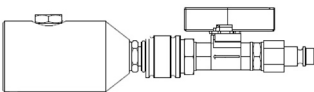



## 8. Troubleshooting

Fault	Possible causes	Remedy
Analog output values too low/too high	- Incorrect scaling or unit	▶ Change scaling or unit in <b>Unit</b> menu
No signal	- Connection interrupted <b>or</b> - Supply voltage too low - Polarity incorrect	▶ Check cables  ▶ Check power: Standard plug min. 12VDC 0554.3302 plug: min. 20VDC
Signal >21mA	- Sensor defect (broken).	Sensor must be replaced. ▶ Contact your local distributor or Testo's Customer Service.
Signal <4mA	- Sensor corroded	Sensor must be replaced. ▶ Contact your local distributor or Testo's Customer Service.
Display <b>oF</b>	- No signal from sensor	▶ Contact your local distributor or Testo's Customer Service.
Displayed reading flashes	- Scaling limits exceeded	▶ Change scaling limits in <b>Unit - S-Lo or S-Hi</b> Menu

If the fault cannot be repaired by following the suggestions given in the above table, please contact your local distributor or Testo's Customer service department. For contact data, see back of this document or web page [www.testo.com/service-contact](http://www.testo.com/service-contact)



## 9. Technical data

### 9.1 Measurement ranges and accuracies

Type of measurement	Measurement range	Accuracy
Pressure dew point temperature (trace humidity)	-60 to +30 °Ctpd	±1 K at ±0 °Ctp ±3 K at -20 °Ctp ±4 K at -40 °Ctp (at 25 °C)
atm. dew point	-80 to -15 °Ctd at 30 bar <sub>rel</sub> -70 to +10 °Ctd at 3 bar <sub>rel</sub> -60 to +30 °Ctd at 0 bar <sub>rel</sub>	cf. pressure dew point temperature
Temperature	±0 to +50 °C	±0.5K

### 9.2 Additional instrument data

Characteristic	Values
Supply voltage	24VDC (standard plug: 12 to 30VDC allowed, 0554.3302 plug: 20 to 28VDC allowed)
Max. load	Standard plug: 12V: 500hm, 24V: 6500hm, 30V: 9500hm 0554.3302 plug: 12V: not allowed, 24V: 6500hm, 30V: not allowed
Ambient temperature	-20 to +70 °C
Storage/transport temperature	-20 to +80 °C
Protection class	IP65 (with plug attached and cable connected)
Rotatability (display alignment)	350°
Humidity sensor	Testo humidity sensor with logged trace humidity-adjustment at -40 °Ctp/6bar
Temperature sensor	NTC
Sensor protection	Stainless steel sintered cap
Pressure resistance	-1 bar <sub>rel</sub> to +50 bar <sub>abs</sub> Measurement chamber 0554.3303: max. 15bar <sub>abs</sub>
Dimensions	199.5x37x37 (with standard plug), 203.5x37x37 (with 0554.3302 plug)
Warranty	2 years
<b>Analog output</b>	
Signal	4 to 20mA, two-wire technology
Scaling	Standard: 4 to 20 mA = -60 to +30 °Ctpd, with freely scalable display
Output parameters	°Ctp, °Ftp, °CtA, °FtA, %RH, ppm <sub>v</sub> , mg/m <sup>3</sup> , °C, °F
Resolution	12 bit
Accuracy	±40µA
<b>Limit value outputs (optional, only with 0554.3302 plug)</b>	
Contacts	2 NO contacts, potential-free, max. circuit 30V/0.5A
Lower switching point (LS + HYST)	+6 °Ctp, with display/scaling adapter freely programmable
Upper switching point (US + HYST)	+12 °Ctp, with display/scaling adapter freely programmable



## 9.3 Uncertainty pressure dewpoint temperature

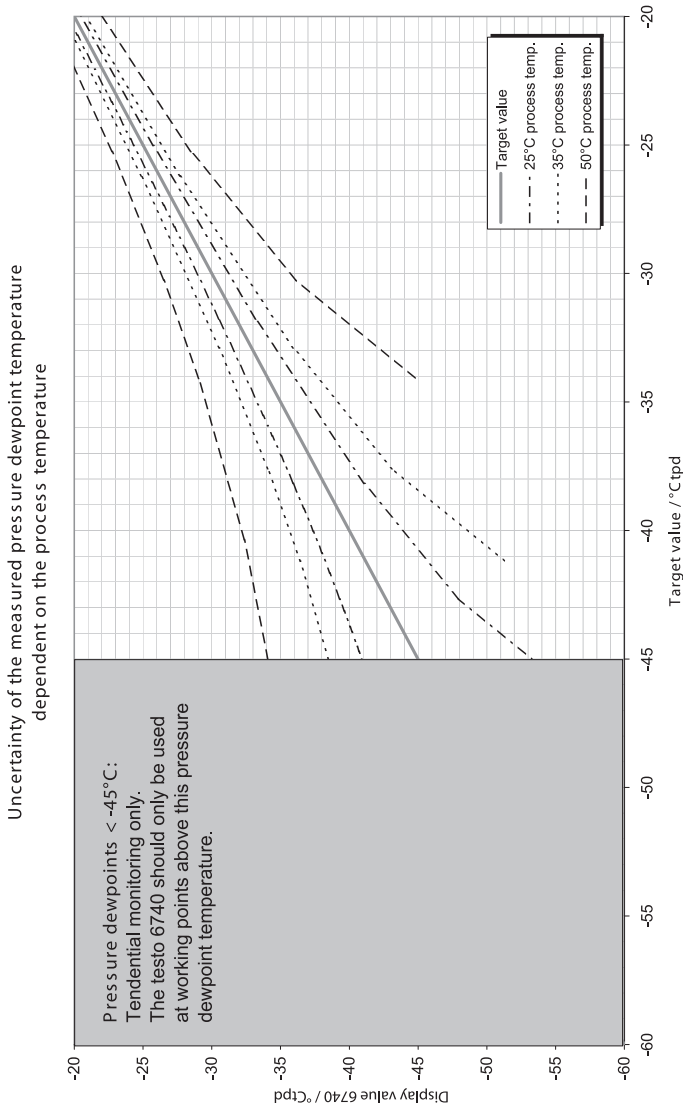

# 10. Accessories/Spare parts

Name	Part no.
<b>Basic instruments (incl. plug for analog signal output)</b>	
with process connection G1/2, without display	0555 6741
with process connection NPT1/2", without display	0555 6742
with process connection G1/2, with display	0555 6743
with process connection NPT1/2", with display	0555 6744
<b>Accessories</b>	
Cable connection plug for power/analog output 4 to 20 mA, with 2 floating switch contacts and 2 LEDs (limit signal output, alarm output)	0554 3302
Measurement chamber for optimum flow on humidity sensor, max. 15 bar, for thread G½	0554 3303
Cooling coil for process temperatures above 50 °C (up to 200 °C)	0554 3304
Scaling adapter for testo 6740	0554 3305
ISO calibration certificate for pressure dew point (-40° to 0° Ctp at 6 bar), free choice of points	0520 0116
ISO calibration certificate for pressure dew point at -10° Ctp and -40° Ctp	0520 0136
External display testo 54-2AC, 2 relay outputs (to 300VAC, 3A), 230VAC	5400 7553
PTFE hose with compressed air connections, 2m, max. 9bar	0699 2824/4
Power unit (desk-top unit), 90 to 264VAC/24VDC (3A)	0554 1748
Power unit (DIN rail mounting), 90 to 264VAC/24VDC (3A)	0554 1749

