



testo Saveris · Adjustment software

Instruction manual



1 Contents

1	Contents	3
2	About this document.....	4
3	Specifications	5
	3.1. Use	5
	3.2. Scope of delivery	5
	3.3. System requirements.....	5
4	First steps	7
	4.1. Software installation	7
	4.2. Installing the driver	8
	4.3. Supplying the Ethernet probe with power	8
	4.4. Connecting the Ethernet probe to the computer	9
	4.5. Supplying the radio probe with power.....	10
	4.6. Connecting the radio probe to the computer.....	10
	4.7. Starting the software.....	11
5	Product description.....	12
6	Using the product.....	13
	6.1. Allocation of password.....	13
	6.2. Preparing for adjustment	13
	6.3. Performing the adjustment:.....	16
	6.4. Printing the adjustment values.....	17
7	Tips and assistance.....	18

2 About this document

Use

- > Please read this documentation through carefully and familiarize yourself with the product before putting it to use. Pay particular attention to the safety instructions and warning advice in order to prevent injuries and damage to the products.
- > Keep this document to hand so that you can refer to it when necessary.
- > Hand this documentation on to any subsequent users of the product.



Knowledge of Windows® operating systems is required when working with the software.

The description in this instruction manual relates to Windows® Vista and Windows® XP.

Symbols and writing standards

Representa- tion	Explanation
	Note: Basic or further information.
1. ...	Action: more steps, the sequence must be followed.
2. ...	
> ...	Action: a step or an optional step.
- ...	Result of an action.
Menu	Elements of the program interface.
[OK]	Buttons of the program interface.
... ...	Functions/paths within a menu.
“...”	Example entries

3 Specifications

3.1. Use

The Saveris adjustment software is used to adjust the radio/Ethernet probes connected to the Saveris base.

Using the Saveris adjustment software and a reference measuring instrument, the temperature and the relative humidity of each individual probe can be adjusted.

After successful adjustment, the current adjustment data is stored in the probe. At the same time, the adjustment software accepts this data so that the adjustment histories are available.



The testo 400/650 with precision humidity probe (order no. 0636 9741) or the precision temperature probe (order no. 0614 0240) is recommended as the reference measuring instrument for adjusting the probes.

3.2. Scope of delivery

The following components are included in the delivery:

- CD with testo Saveris adjustment software including instruction manual.
- Adjustment cable for connecting the radio probes to the USB adapter.
- USB cable including USB adapter for connecting the Ethernet and radio probes to the computer.

3.3. System requirements

Computer

For smooth work with the software, the following requirement should be met:

- Pentium processor of at least 1.2 GHz or equivalent
- 256 MB RAM
- 50 MB unused hard drive capacity
- CD-ROM drive
- USB 2.0 interface
- Internet Explorer 5.5 Service Pack 1 or higher

Operating system

The adjustment software works on the following operating systems:

- Windows Vista
- Windows® XP SP2
- Windows® XP without ServicePack 2
- Windows® 2000 SP4

4 First steps



Administrator rights are required for installation.

4.1. Software installation

Windows Vista

1. Insert program CD in the CD-ROM drive of the computer.
 - > If the installation program does not start automatically:
Start | **Computer** | Select the CD drive | Start **Setup.exe** (double click on left mouse button).
 - The **User Account Control** window opens.
2. Click on **[Continue]**.
3. Follow the directions of the installation wizard.
4. To finish the software installation: Click on **[Finish]**.
 - The software was successfully installed on the computer.

Windows XP

When installing under Windows XP, please note the following steps during the installation procedure:

1. Insert program CD in the CD-ROM drive of the computer.
 - > If the installation program does not start automatically: Open **My Computer** | Select the CD drive | Start **Setup.exe** (double click on left mouse button).
2. Follow the directions of the installation wizard.
3. To finish the software installation, click on **[Finish]**.
 - The software was successfully installed on the computer.

4.2. Installing the driver

i The drivers required for the Saveris adjustment software can be found on the program CD for the Saveris software (SEE/Prof).

The drivers only have to be installed if the Saveris software is not installed on this computer.

1. Insert program CD for the Saveris software (SEE/Prof) in the CD drive.
2. If the installation program starts automatically: click on **[Cancel]**.
3. To start the Driver.exe file:
 - > Windows Vista: **Start | Computer** | Select the CD drive | Open the **USBDriver** folder | Open the **EthernetProbe** folder | Start **InstallTestoUSBDriver.exe**.
 - > Windows XP: Open My Computer | Select the CD drive | Open the **USBDriver** folder | Open the **EthernetProbe** folder | Start **InstallTestoUSBDriver.exe**.
- The installation wizard opens.
4. Follow the directions of the installation wizard.
5. To finish the driver installation: click on **[Finish]**.
- The driver for the Saveris adjustment software was successfully installed on the computer.

4.3. Supplying the Ethernet probe with power

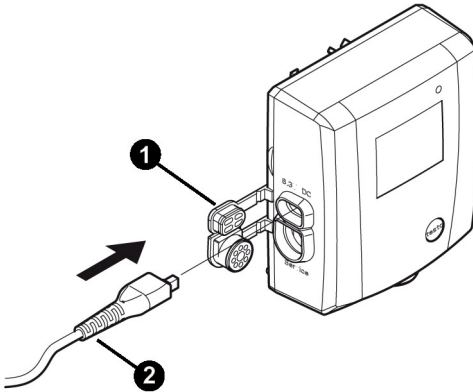

1. Open the cover **1** for the power supply.

2. Connect mains cable ❷ to the Ethernet probe.
3. Insert mains plug into a socket.
- The Ethernet probe is supplied with power

4.4. Connecting the Ethernet probe to the computer

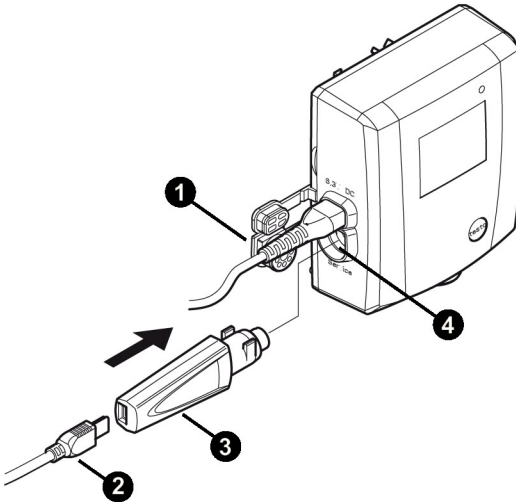

1. Open the cover ❶ for the service interface.
2. Connect the USB cable ❷ to the testo USB adapter ❸ and insert in the service interface ❹ .
3. Connect the USB cable to the computer.
- The Ethernet probe is connected to the computer.

4.5. Supplying the radio probe with power

i The radio probe is supplied with power via the adjustment cable as soon as it is connected to the computer.

4.6. Connecting the radio probe to the computer

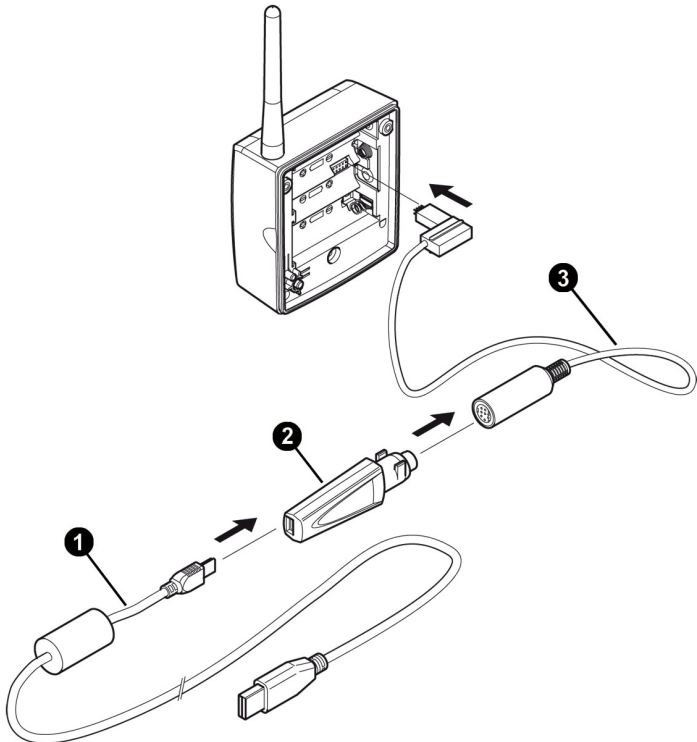

1. Loosen screws on the rear of the probe.
2. Remove housing cover of radio probe.
3. Remove batteries.
4. Connect the USB cable ❶ to the testo USB adapter ❷ .
5. Connect the testo USB adapter ❷ to the adjustment cable ❸ .
6. Connect the adjustment cable ❸ to the radio probe as shown.
7. Connect the USB cable ❶ to the computer.

- The radio probe is connected to the computer.

4.7. Starting the software



Please observe the following notes before starting the Saveris adjustment software:

- **One** probe (Ethernet or radio) must be connected to the computer, see Connecting the Ethernet probe to the computer page 9 or Connecting the radio probe to the computer page 10 .
 - For secure data transmission, the probes must be supplied with power, see Supplying the Ethernet probe with power page 8 or Supplying the radio probe with power page 10.
 - The user interface of the software is opened in the language of the operating system if this is supported. If the operating system language is not supported, the user interface is in English.
-

1. Click on **[Start]** | **All Programs** (Windows Vista) or **Programs** (Windows XP) | **Testo** | **Saveris Adjustment Software** (double click on left mouse button).
 2. When the **User Account Control** window opens: click on **[Continue]**.
- The screen asking for a user name and password opens.
-



Please observe the following notes with regard to the user name and password:

- The user name and password are not linked to each other.
 - The user name is used to record the adjustment process. It is stored in the probe together with the adjustment data to record who has performed an adjustment.
 - The password protects the adjustment data in the probe against unauthorized modification. The password is stored in the probe and a separate password is assigned to each probe.
-

3. Enter the user name.
 4. Enter the password for the probe connected. If you do not yet have an individual password for the probe: enter "testo".
 5. Click on **[OK]**.
- The adjustment software starts.

5 Product description

User interface

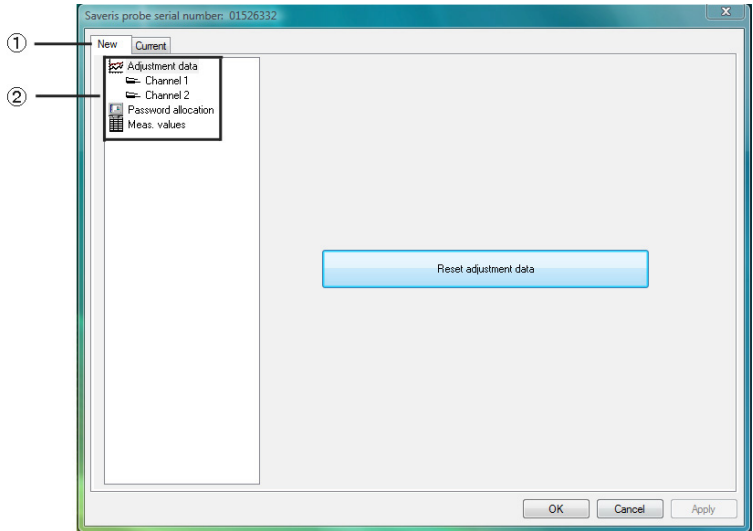

- ① Tab: The view of the work space changes according to the tab selected (**[New]** or **[Current]**).

[New] tab:

Editing is performed and the probes readjusted under the **[New]** tab.

[Current] tab:

Shows the current adjustment values of the probe

- Channel 1 = information for adjusting the temperature
- Channel 2 = information for adjusting the relative humidity

- ② Work space: Information is shown and editing performed on the work space.

6 Using the product

6.1. Allocation of password

Allocate a probe -specific password to protect the adjustment data against unauthorized access.



Please observe the following notes regarding the allocation of passwords:

- The password protects the adjustment data in the probe against unauthorized modification. The password is stored in the probe and a separate password is assigned to each probe.
- Once a password has been allocated, the adjustment software can only be opened if the password for the respective probe connected is entered.
- The password must not have more than 16 Latin characters.

-
1. Click on the **[New]** tab.
 2. Under the list of functions, click on **Password allocation** .
 - > If no password has yet been allocated: enter a new password in the text field.
 - > If a password has already been allocated: Click on **[Reset password]** and enter a new password in the text field.
 3. Click on **[Accept new password]**.
 - The new password is accepted.

6.2. Preparing for adjustment



Please observe the following notes before performing any adjustment:

- Adjustment data must always be reset.
 - Current measured values of probe must be determined.
-

Resetting the adjustment data

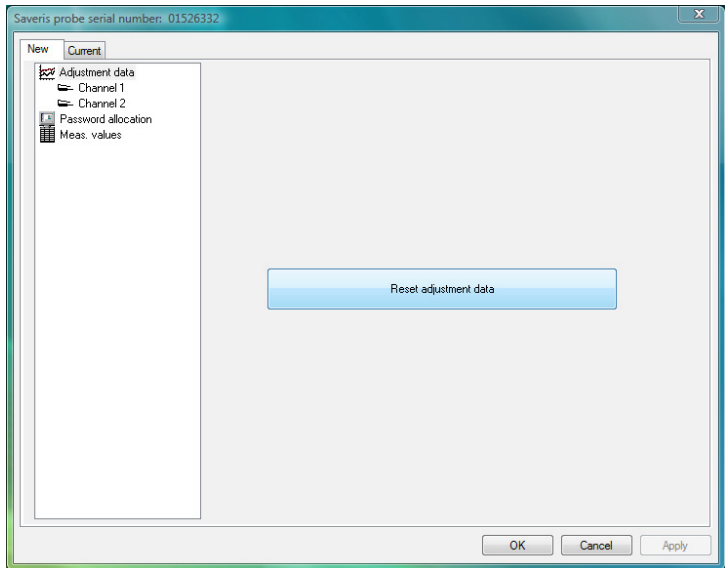

1. Click on the **[New]** tab.
2. In the list of functions, click on **Adjustment data** .
3. Click on **[Reset adjustment data]**.
 - The confirmation request is opened.
 - > If you wish to reset the adjustment data: click on **[Yes]** (required for a new adjustment of the probe).
 - > If you wish to cancel the process: click on **[No]**.

Determining the current measured values

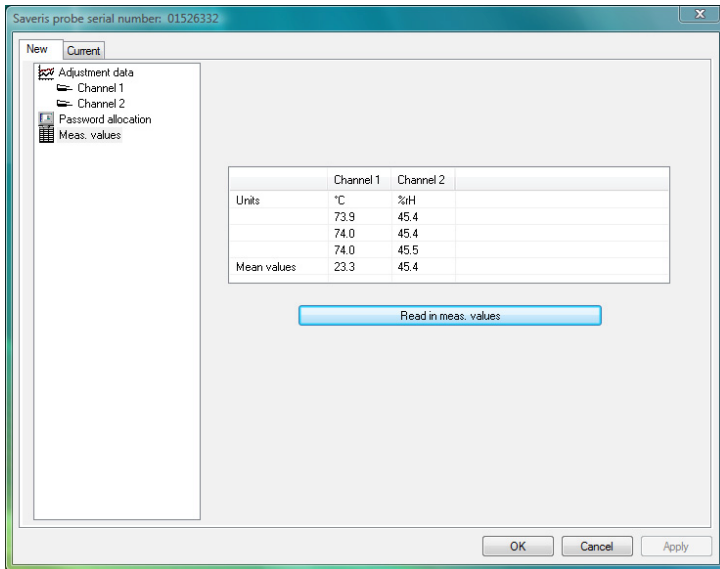

1. Expose reference measuring instrument and the probes to be adjusted to the same constant ambient conditions.
2. Click on the **[New]** tab.
3. In the list of functions, click on **Meas. values** .
4. Click on **[Read in meas. values]**.
5. Wait until the current measured values of the probe are displayed in the table.
 - **Channel 1** shows the measured temperature values (°C).
 - **Channel 2** shows the measured relative humidity values (RH%).
6. Wait for equalization period to elapse, until the reference instrument and the probe supply stable measured values.



Alternatively, you can also read the measured values from the display on the probe (if present).

6.3. Performing the adjustment:

Requirement:

- The adjustment data have been reset, see Resetting the adjustment data page 14.
- Current measured values of probe have been determined, see Determining the current measured values page 15.

Saveris probe serial number: 01526332

New Current

Adjustment data

- Channel 1
- Channel 2
- Password allocation
- Meas. values

Data sheet number: 1

Sheet date: 17/06/2008

Channel number: 1

Text: Ref. testo 400

User: A.N.Other



No. of points/channel: 3

Point	Target	Current	Offset	Unit
1	24.00	23.20	0.80	°C
2	30.00	29.50	0.50	°C
3	35.00	35.30	-0.30	°C

Reminder

Next calibration on: 17/10/2008

OK Cancel Apply

1. Click on the **[New]** tab.
 - > If you wish to adjust the temperature (°C) of the probe: click on **Channel 1**  in the list of functions **or**
 - > If you wish to adjust the relative humidity (RH%) of the probe: click on **Channel 2**  in the list of functions.
2. Enter the data sheet number.
3. Enter date of adjustment.
4. Enter text (e.g. product no. of reference measuring instrument or similar)
5. Specify the number of adjustment points.
6. Enter the actual value from the data calculated (see list of functions under **Meas. values**) in the table (**ACTUAL** column).

i The current measured values of the probe must be recalculated for each adjustment point, see **Determining the current measured values** page 15.



7. Enter the nominal value for the reference measuring instrument in the table (**NOMINAL** column).
 - The adjustment software calculates the offset (difference between NOMINAL and ACTUAL values)
 - > Enter date of next adjustment (reminder function).
 8. To finish the adjustment:
 - > Transfer adjustment data to the probe and store in the software, do not close the software: click on **[Apply]**.
 - > Transfer adjustment data to the probe and store in the software, close the software: click on **[OK]**.
-

i

- The adjustment data are stored under the following path:
 - Windows 2000/XP: C:\Documents and Settings\All Users\Documents\Saveris adjustment software.
 - Windows Vista: C:\users\public\documents\saveris adjustment software.
- The adjustment data can be imported into the Saveris software (see Instruction Manual Saveris software).

- > Cancel the adjustment without transferring the data to the probe and storing it in the software, close the software: click on **[Cancel]**.

6.4. Printing the adjustment values

1. Click on the **[Current]** tab.
 - The current adjustment values for the probe are displayed.
2. To change between the temperature and relative humidity values: Click on **Channel 1**  or **Channel 2**  in the list of functions.
 - The adjustment values for the temperature (channel 1) or relative humidity (channel 2) are displayed.
3. Click on **[Print]**.
 - The adjustment values for the temperature (°C) or relative humidity (RH%) are printed out.

Performing print settings

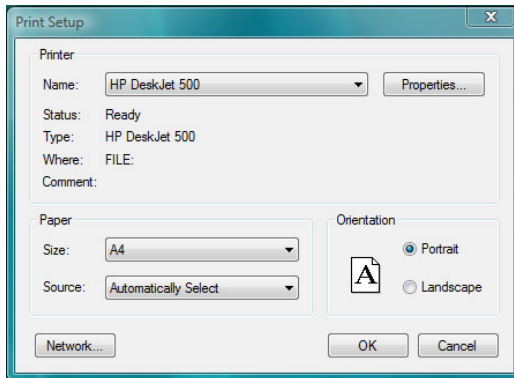

1. Click on the **[Current]** tab.
2. Click on **[Set up printer...]**.
3. Select the printer and perform the settings.
4. Click on **[OK]**.
 - The settings are accepted.
 - The current adjustment values are shown.

7 Tips and assistance

If you have any questions, please contact your dealer or Testo Customer Service. The contact details can be found on the back of this document or on the Internet at www.testo.com/service-contact.

