

GasAlertMicro

H₂S, CO, O₂, SO₂, Combustibles

1, 2, 3 and 4 Gas Detectors

User Manual

"INNOVATORS IN GAS DETECTION"



Limited Warranty & Limitation of Liability

BW Technologies Ltd. (BW) warrants this product to be free from defects in material and workmanship under normal use and service for a period of two years, beginning on the date of shipment to the buyer. This warranty extends only to the sale of new and unused products to the original buyer. BW's warranty obligation is limited, at BW's option, to refund of the purchase price, repair, or replacement of a defective product that is returned to a BW authorized service center within the warranty period. In no event shall BW's liability hereunder exceed the purchase price actually paid by the buyer for the Product.

This warranty does not include:

- a) fuses, disposable batteries or the routine replacement of parts due to the normal wear and tear of the product arising from use;
- b) any product which in BW's opinion, has been misused, altered, neglected or damaged by accident or abnormal conditions of operation, handling or use;
- c) any damage or defects attributable to repair of the product by any person other than an authorized dealer, or the installation of unapproved parts on the product; or

The obligations set forth in this warranty are conditional on:

- a) proper storage, installation, calibration, use, maintenance and compliance with the product manual instructions and any other applicable recommendations of BW;
- b) the buyer promptly notifying BW of any defect and, if required, promptly making the product available for correction. No goods shall be returned to BW until receipt by the buyer of shipping instructions from BW; and
- c) the right of BW to require that the buyer provide proof of purchase such as the original invoice, bill of sale or packing slip to establish that the product is within the warranty period.

THE BUYER AGREES THAT THIS WARRANTY IS THE BUYER'S SOLE AND EXCLUSIVE REMEDY AND IS IN LIEU OF ALL OTHER WARRANTIES, EXPRESS OR IMPLIED, INCLUDING BUT NOT LIMITED TO ANY IMPLIED WARRANTY OF MERCHANTABILITY OR FITNESS FOR A PARTICULAR PURPOSE. BW SHALL NOT BE LIABLE FOR ANY SPECIAL, INDIRECT, INCIDENTAL OR CONSEQUENTIAL DAMAGES OR LOSSES, INCLUDING LOSS OF DATA, WHETHER ARISING FROM BREACH OF WARRANTY OR BASED ON CONTRACT, TORT OR RELIANCE OR ANY OTHER THEORY. Since some countries or states do not allow limitation of the term of an implied warranty, or exclusion or limitation of incidental or consequential damages, the limitations and exclusions of this warranty may not apply to every buyer. If any provision of this warranty is held invalid or unenforceable by a court of competent jurisdiction, such holding will not affect the validity or enforceability of any other provision.

BW Technologies Ltd.
2840 – 2nd Ave. SE
Calgary, AB T2A 7X9
Canada

BW Technologies Inc. (America)
3279 West Pioneer Parkway
Arlington, TX 76013
USA

BW Europe Ltd.
101 Heyford Park,
Upper Heyford, Oxfordshire OX25 5HA
United Kingdom

Table of Contents

Title	Page
Introduction.....	1
Contacting BW Technologies.....	2
Safety Information - Read First.....	2
Getting Started.....	6
Activating the Detector.....	10
Self-Test.....	10
Self-Test Pass.....	11
Self-Test Fail.....	12
Battery Test.....	12
Datalogger Operation.....	12
Deactivating the Detector.....	12
Confidence Beep.....	13
User Option Menu.....	13
Latched Alarms Function.....	14
“SAFE” Display Enable or Disable.....	14
Combustible Sensor Measuring Selection.....	15
Language Selection.....	16
Sensor Enable or Disable.....	16
Pass Code Protection.....	17
To activate or deactivate Pass Code Protect.....	17
To enter the pass code.....	17
Pass code not entered or entered incorrectly.....	17
Automatic Oxygen Calibration Enable or Disable.....	18

	Set Span Concentration Values	18
	STEL Calculation Period.....	19
	“Stealth Mode”	19
	Change the Date and Time.....	20
	Adjust Datalogger Sampling Rate	20
Alarms	21
	Gas Exposures Computed.....	24
	Viewing Gas Exposures.....	24
	Gas Alarm Setpoints	25
	Resetting Gas Alarm Setpoints.....	25
	Stopping a Gas Alarm.....	26
	Sensor Alarm	26
	Low Battery Alarm.....	26
	Automatic Shutdown Alarm	26
Calibration and Setting Alarm Setpoints	27
	Guidelines	27
	Diagnostics Protection	28
	Applying Gas to the Sensors	28
	Calibration Procedure	29
	Start Calibration	29
	Auto Zero and Oxygen Sensor Calibration.....	29
	Auto Span	30
	Alarm Setpoints.....	31
	Setting the TWA Alarm Setpoint.....	32
	Setting the STEL Alarm Setpoint.....	32
	Setting the LOW Alarm Setpoint.....	32
	Setting the HIGH Alarm Setpoint.....	33
	Setting the Remaining Alarm Setpoints.....	33
	Setting the Calibration Due Date.....	33

Verification (optional).....	33
Maintenance.....	34
Replacing the Batteries	34
Replacing a Sensor or Sensor Filter	36
Installing the MultiMediaCard (MMC).....	38
If the Detector Does Not Work	39
Replacement Parts and Accessories.....	42
Specifications	44
Appendix A.....	47
Excel Datalog Manager (E.D.M.).....	47
Excel Datalog Manager (E.D.M.) Software Plug-in	47
Sample Data Files	47
Installing Excel Datalog Manager (E.D.M.):	48
MMC Card Reader Installation	48
Types of MultiMediaCard Readers	48
Start Excel Datalog Manager.....	49
Import Your Data File.....	49
E.D.M. Workbook Features and Functions.....	52
Data workbook format.....	52
Titles and worksheets.....	52
Type and order of displayed data.....	52
Overlapping or older data.....	52
Working with the data	53
Entering user data or comments	53
Changing or removing the preformatted cell color-coding	53
Sorting: Reorganizing the data.....	53
Filtering: Restricting the viewed data by date, gas reading or status code.....	54
Charting: Automatically charting the data	54
Charting: Manually charting the data.....	55

Printing: Printing the data	55
Security: Locking or protecting the data	56
Customization: Calculating long-term average exposures.....	56
Importing the Data File Into Compatible Desktop Applications	56
Determining Application Compatibility	56
MultiMediaCard Compatibility	61
MultiMediaCard Troubleshooting	61
Recovering Data Files	61

List of Tables

Table	Title	Page
1.	Gases Monitored.....	1
2.	International Symbols	5
3.	GasAlertMicro Detector	7
4.	Display Elements	8
5.	Pushbuttons	9
6.	Alarms	21
7.	Computed Gas Exposures.....	24
8.	Gas Alarm Setpoints.....	25
9.	Sample Factory Set Alarm Setpoints.....	25
10.	Applying Gas to the Sensors	28
11.	Replacing the Batteries.....	35
12.	Replacing a Sensor or Sensor Filter.....	36
13.	Troubleshooting Tips	39
14.	Replacement Parts and Accessories.....	42
A:	Datalogger Status Codes.....	57

List of Figures

Figure	Title	Page
1.	GasAlertMicro Detector	7
2.	Display Elements	8
3.	Applying Gas to the Sensors	28
4.	Replacing the Batteries	35
5.	Replacing a Sensor or Sensor Filter	37
6.	Installing the MultiMediaCard (MMC)	38

CAUTION: FOR SAFETY REASONS, THIS EQUIPMENT MUST BE OPERATED AND SERVICED BY QUALIFIED PERSONNEL ONLY. READ AND UNDERSTAND INSTRUCTION MANUAL COMPLETELY BEFORE OPERATING OR SERVICING.

GasAlertMicro Gas Detector

Order Number	Description
GAMIC-4	GasAlertMicro (4 Gas) Detector (H ₂ S, CO, O ₂ , *Combustibles)
GAMIC-3H	GasAlertMicro (3 Gas) Detector (H ₂ S, O ₂ , *Combustibles)
GAMIC-3M	GasAlertMicro (3 Gas) Detector (CO, O ₂ , *Combustibles)
GAMIC-3S	GasAlertMicro (3 Gas) Detector (SO ₂ , O ₂ , *Combustibles)
GAMIC-3X	GasAlertMicro (3 Gas) Detector (H ₂ S, CO, O ₂)
GAMIC-2	GasAlertMicro (2 Gas) Detector (O ₂ , *Combustibles)
GAMIC-2HW	GasAlertMicro (2 Gas) Detector (H ₂ S, *Combustibles)
GAMIC-2HM	GasAlertMicro (2 Gas) Detector (H ₂ S, CO)
GAMIC-2HX	GasAlertMicro (2 Gas) Detector (H ₂ S, O ₂)
GAMIC-2MW	GasAlertMicro (2 Gas) Detector (CO, *Combustibles)
GAMIC-2MX	GasAlertMicro (2 Gas) Detector (CO, O ₂)
GAMIC-W	GasAlertMicro (1 Gas) Detector (*Combustibles)
GAMIC-H	GasAlertMicro (1 Gas) Detector (H ₂ S)
GAMIC-M	GasAlertMicro (1 Gas) Detector (CO)
GAMIC-X	GasAlertMicro (1 Gas) Detector (O ₂)

For other gas combinations please contact BW Technologies . See "[P.2](#)".

Add suffix "-DL2-IR" for detectors equipped with datalogger.

Versions with -IR suffix are MicroDock compatible.

Add suffix (-UK) for United Kingdom mains plug, (-EU) for European mains plug, (-AU) for Australian mains plug.

* Combustibles: Field-selectable for 0-100% LEL (lower explosive limit) or 0-5.0% methane v/v.

GasAlertMicro Multi-Gas Detector

Standard instrument is equipped with integral concussion-proof boot and internal vibrator alarm.

GasAlertMicro with User Downloadable Datalogger

Provides full time continuous datalogging while the instrument is operating. Data is saved on a convenient MultiMediaCard and can be removed and downloaded by the user. Data is imported into standard office software (Microsoft® Excel, Access etc.). Wraparound memory ensures the most recent data is always saved.

GasAlertMicro

Introduction

Warning

To ensure your personal safety, read “Safety Information” before you use the detector.

The GasAlertMicro gas detector (“the detector”) warns of hazardous gas at levels above user-selectable alarm setpoints. This product is a gas detector.

The detector is a personal safety device. It is your responsibility to respond properly to the alarm.

Table 1 lists the gases monitored.

Table 1. Gases Monitored

Gas Detected	Unit of Measure
Hydrogen Sulfide (H ₂ S)	parts per million (ppm)
Carbon Monoxide (CO)	parts per million (ppm)
Oxygen (O ₂)	percent by volume (%)
Combustible Gases Field selectable for:	a) percent of lower explosive limit (% LEL) b) percent by volume methane 0-5.0% v/v
Sulfur Dioxide (SO ₂)	parts per million (ppm)

Contacting BW Technologies

To contact BW Technologies, call:

1-888-749-8878 USA
1-800-663-4164 Canada
+44 (0) 1869 233004 Europe
+971-4-8871766 Middle East
+61-7-3818-8244 Australia
+852-2974-1783 China
+65-687-39813 South East Asia
+1-403-248-9226 other countries

Address correspondence to:

BW Technologies Ltd.
2840 – 2 Avenue S.E.
Calgary, AB T2A 7X9
CANADA

Or visit us on the World Wide Web:

<http://www.gasmonitors.com/>

ISO 9001

Safety Information - Read First

Use the detector only as specified in this manual, otherwise the protection provided by the detector may be impaired.

International symbols used on the detector and in this manual are explained in Table 2.

Read the **Warnings** and **Cautions** on the following pages before using the detector.



This instrument contains batteries. Do not mix with the solid waste stream. Spent batteries should be disposed of by a qualified recycler or hazardous materials handler.

⚠ Cautions

- ⇒ **Warning:** Substitution of components may impair Intrinsic Safety.
- ⇒ Do not use the detector if it is damaged. Before you use the detector, inspect the case. Look for cracks or missing parts.
- ⇒ If the detector is damaged or something is missing, contact BW Technologies immediately. See “[Contacting BW Technologies](#)”.
- ⇒ Make sure the battery holder is locked in place before you operate the detector.
- ⇒ Use only a sensor specifically designed for your GasAlertMicro model. (See the section “Replacement Parts and Accessories.”)
- ⇒ Calibrate the detector before first-time use and then on a regular schedule, depending on use and sensor exposure to poisons and contaminants. BW recommends at least once every 180 days (6 months).
- ⇒ BW recommends to “bump test” the sensors, before each day’s use, to confirm their ability to respond to gas by exposing the detector to a gas concentration that exceeds the high alarm setpoints. Manually verify that the audible and visual alarms are activated. Calibrate if the readings are not within the specified limits.
- ⇒ It is recommended that the combustible sensor be checked with a known concentration of calibration gas after any known exposure to catalyst contaminants/poisons (sulfur compounds, silicon vapors, halogenated compounds, etc.).



⚠ Cautions (cont.)

- ⇒ **The combustible sensor is factory calibrated to 50% LEL methane. If monitoring a different combustible gas in the % LEL range, calibrate the sensor using the appropriate gas. High off-scale % LEL or % v/v methane readings may indicate an explosive concentration.**
- ⇒ **Protect the combustible sensor from exposure to lead compounds, silicones and chlorinated hydrocarbons. Although certain organic vapors (such as leaded gasoline and halogenated hydrocarbons) may temporarily inhibit sensor performance, in most cases, the sensor will recover after calibration.**
- ⇒ **Any rapid up-scaling reading followed by a declining or erratic reading may indicate a gas concentration beyond upper scale limit, which may be hazardous.**
- ⇒ **Use only recommended AA alkaline or NiMH batteries properly charged, and installed in the detector case. (See the section “Replacement Parts and Accessories.”)**
- ⇒ **Charge NiMH batteries using recommended charger only. Do not use any other charger. Failure to observe this precaution could lead to fire or explosion.**
- ⇒ **Do not change or charge batteries in a hazardous location. Doing so will impair the Intrinsic Safety of the unit and may lead to fire or explosion.**
- ⇒ **Read and observe all instructions and precautions in the literature provided with the charger. Failure to do so may result in fire, electric shock or other forms of personal injury or property damage.**

⚠ Cautions (cont.)

- ⇒ **Extended exposure of the GasAlertMicro to certain concentrations of combustible gases and air may stress a detector element, which can seriously affect its performance. If an alarm occurs due to high concentration of combustible gases, recalibration should be performed, or if needed, the sensor replaced.**
- ⇒ **Do not test the combustible sensor’s response with a butane cigarette lighter; doing so will damage the sensor.**
- ⇒ **Do not expose the detector to electrical shock and/or severe continuous mechanical shock.**
- ⇒ **Do not attempt to disassemble, adjust or service the detector unless instructions for that procedure are contained in the manual and/or that part is listed as a replacement part. Use only BW Technologies replacement parts.**
- ⇒ **Do not immerse the detector in liquids.**
- ⇒ **The detector Warranty will be voided if customer, personnel or third parties damage the detector during repair attempts. Non-BW Technologies repair/service attempts void this Warranty.**

Table 2. International Symbols

Symbol	Meaning
	Approved to both U.S. and Canadian Standards by the Canadian Standards Association.
	European Explosion Protection
CE	Conforms to European Union directives
BAM	BAM performance verification and expert opinion
ATEX	Conforms to European Directive 94/9/EC – ATEX 95
AUS	Certified to Australian standards
	Type Approved by ABS Americas for use aboard Cargo Vessels.

Getting Started

The items listed below are included with your detector. If the detector is damaged or something is missing, contact the place of purchase immediately.

- Batteries (two replaceable alkaline cells or four NiMH rechargeable cells or one GA MicroBatt cell)
- Charger (if applicable) (one AC line charger or one DC vehicle charger or one GA MicroBatt charger)
- O₂ sensor
- Combustible sensor
- 4-gas units: H₂S/CO sensor (dual sensor)
- 3-gas units: applicable toxic sensor
- Calibration hose and cap
- Instructions
- CD

To order replacement parts, see the section "[Replacement Parts and Accessories](#)".

The detector comes with sensors installed. The "[Maintenance](#)" section describes how to install the batteries.

To become familiar with the features and functions of the detector, study the following figures and tables:

- Figure 1 and Table 3 describe the detector's components.
- Figure 2 and Table 4 describe the detector's display elements.
- Table 5 describes the detector's pushbuttons.

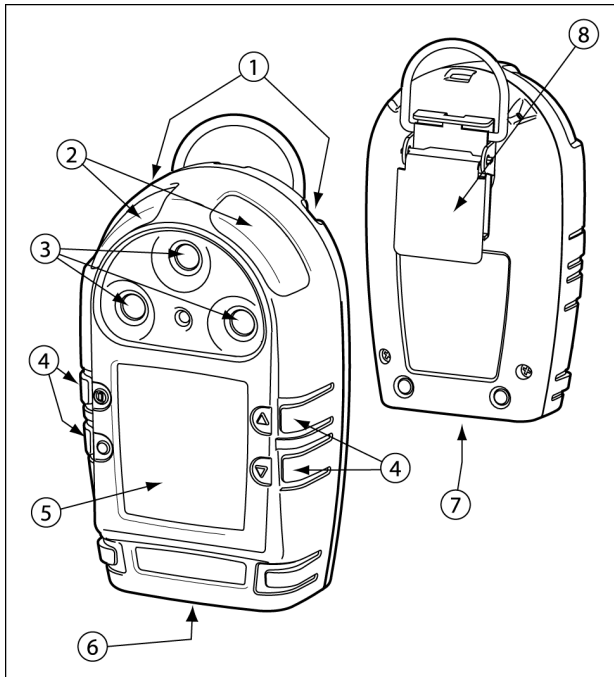

Figure 1. GasAlertMicro Detector

Table 3. GasAlertMicro Detector

Item	Function
①	Audible Alarm
②	Visual Alarm Bars
③	Sensors
④	Pushbuttons
⑤	Display
⑥	Battery Holder
⑦	Datalogger (optional)
⑧	Alligator Clip

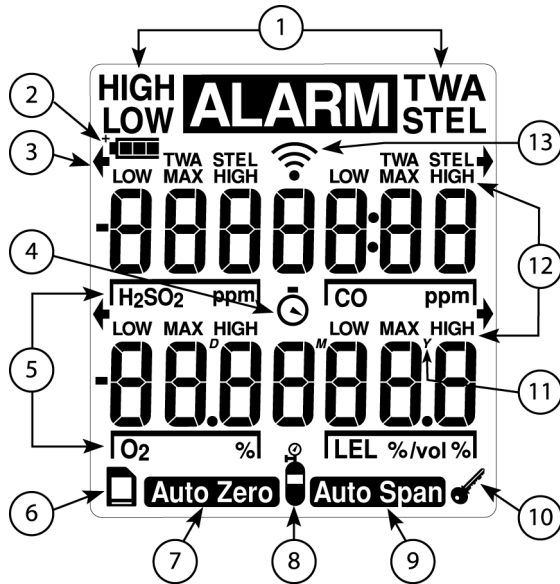

Figure 2. Display Elements

Note: The display backlight automatically activates for 10 seconds whenever there is insufficient light to view the display and during alarm conditions. Any pushbutton reactivates the backlight in low-light conditions.

Table 4. Display Elements

Item	Function
①	Alarm Condition
②	Battery
③	Button Indicator
④	Clock
⑤	Gas Identifier Bars
⑥	Optional Datalogger Card Indicator
⑦	Automatically Zero Sensor
⑧	Gas Cylinder
⑨	Automatically Span Sensor
⑩	Pass Code Lock
⑪	Real Time Calendar (Date, Month, Year)
⑫	Alarm Condition (Low, High TWA, STEL or Multi-gas) or view TWA, STEL and Maximum Gas Exposures
⑬	Future Use

























Note: The button indicator  will be displayed where an option allows a button press.

Table 5. Pushbuttons

Pushbutton	Description
 ON/OFF	<ul style="list-style-type: none"> To turn on the detector, press . To turn off the detector, press  and hold for 5 seconds. To activate or deactivate the confidence beep, press and hold  then press  at startup. To quit at any point after auto zero, press . The detector retains any saved values, and the audible alarm beeps 5 times before the detector returns to normal operation.
	<ul style="list-style-type: none"> To increment the displayed value or scroll up, press . To enter the user options menu, press  and  simultaneously and hold for 5 seconds. To clear the TWA, STEL and maximum gas exposure readings, press  and  simultaneously. To quickly scroll through options, press and hold .
	<ul style="list-style-type: none"> To decrement the displayed value or scroll down, press . To initiate calibration and setting alarm setpoints, press  and  simultaneously and hold for 5 seconds. To quickly scroll through options, press and hold .
 OK/Tab	<ul style="list-style-type: none"> To view the TWA, STEL and maximum (MAX) hold readings, press . To acknowledge latched alarms, press . To acknowledge a failed bump test screen, press . At any point after auto zero but before calibration gas is detected, press  to bypass calibration and proceed to alarm setpoints.

Activating the Detector

⇒ To activate the detector, press  in a normal atmosphere (20.9% Oxygen).

Self-Test

The detector performs the actions in steps 1-9. Manually, check that all actions occur.

Note: If battery power is low  **LOW** flashes, the display reads **OFF**. Replace the batteries and restart the detector.



1. The display shows all the display elements.
2. The detector beeps and flashes.
3. The detector briefly turns on the backlight.
4. *User Downloadable Datalogger units only (-DL2-IR):*
The display shows the time, day and date.
5. The display shows the TWA, STEL, Low and High Alarm setpoints.

Note: The alarm setpoints on a shipped detector may vary by region. See [“Resetting Gas Alarm Setpoints”](#).

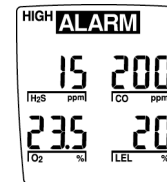
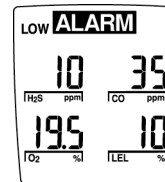
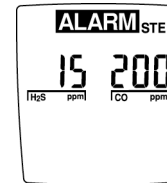
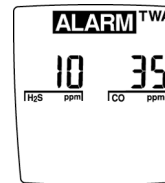

6. Calibration status is shown.

Number of days remaining before calibration due is displayed. If calibration is overdue, a warning will sound and the LCD will show the number of days overdue. Press  to acknowledge the warning. BW recommends that you calibrate the detector.

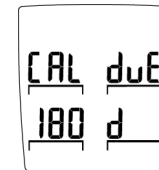

Note: If the detector has recently failed a bump test in the MicroDock Test and Calibration Station the display will read **note: bump test HAS FAILED**. Press to acknowledge the warning. BW recommends that you retest the detector.

- The display reads **TEST** as the detector tests the sensors.

If a sensor fails the self-test, the audible alarm emits a slow modulating tone, the visual alarm flashes slowly and the vibrator alarm activates. The LCD advises which sensor failed. For example **-Error- Sensor 2 HAS FAILED**.

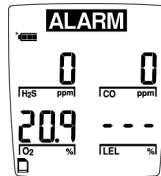

- Sensor 1: CO/H₂S or SO₂
 - Sensor 2: LEL
 - Sensor 3 Oxygen
- User Downloadable Datalogger units only:** If there is no MMC card installed the display reads **no card INSTALLED**. The card is not required for operation of the User Downloadable Datalogger models.
 - The Oxygen sensor is calibrated automatically, unless it is disabled.



Note: If the automatic Oxygen calibration feature has been disabled the display will read **o2 CAL IS OFF**.

Self-Test Pass

If the detector passes the self-test, the detector begins normal operation. The display shows the ambient gas readings:

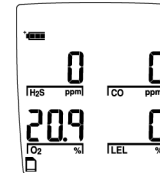

The detector starts recording the maximum gas exposure and calculating the STEL (short-term exposure level) and TWA (time-weighted average) exposures. If the SAFE display is activated, **SAFE** will scroll across the screen.

Self-Test Fail

If the detector fails the self-test, see the section [“If the Detector Does Not Work”](#).

Battery Test

The batteries are tested on activation and continuously thereafter. Battery power is continually displayed during normal operation. If battery power is low,  **LOW** flashes.

Note: *If the Confidence Beep is on, the audible alarm beeps if the batteries have sufficient power and stops if the battery power is low. See the section [Confidence Beep](#)*

Datalogger Operation

Datalogger operation is automatic and requires no settings.

The MultiMediaCard icon  is displayed continuously in datalogger units when the card is present. The card is not required for operation of the User Downloadable Datalogger models. A warning message will display if the card is absent.

Deactivating the Detector

⇒ To turn off the detector, press  and hold for 5 seconds.

The audible alarm beeps four times, the visual alarm flashes four times and then the display shows:

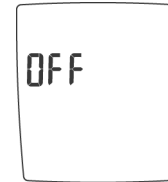



The display turns off and the detector stops normal operation.

Note: *If  is held down for less than 5 seconds, the detector will not turn off.*

Confidence Beep

The Confidence Beep tells you the detector is on and the batteries have sufficient power to respond to a hazardous level of gas and emit an alarm. Instead of beeping when battery power is low, the audible alarm beeps (once every 5 seconds) to advise you the batteries have sufficient power. The Confidence Beep stops when battery power is low.

You can activate or deactivate the Confidence Beep only at startup.

1. To activate or deactivate the confidence beep, press and hold  then press  at startup.

Note: Normal one button startup and shutdown will not deactivate the Confidence Beep. If the Confidence Beep has been deactivated it will remain deactivated through future normal startups.

User Option Menu



Note: If the detector is pass code protected, attempting to enter the user option menu will cause the detector to prompt for the pass code before proceeding. See the section "[Pass Code Protection](#)".

User options are:

1. Finish options and exit User Options Menu.

2. Enable or disable latching alarms.
3. Enable or disable "SAFE" display mode.
4. Combustible sensor measuring selection: %LEL or % by volume. [% by volume for methane only.]
5. Language Selection(s)
6. Enable or disable operation of one or more sensors.
7. Enable or disable Pass Code Protection.
8. Enable or disable automatic Oxygen calibration at start up.
9. Set Span concentration values
10. Set STEL calculation period
11. Enable or disable "stealth" mode.
12. Datalogger model only:
Adjust real-time clock and calendar.
13. Datalogger model only:
Adjust datalogger sampling rate from 1 to 127 seconds.

Note: The button indicator  will be displayed where an option allows a button press.

To enter the user options menu, press  and  simultaneously and hold for 5 seconds until the display reads:



To choose the desired options, press \blacktriangledown or \blacktriangle . Press \bigcirc to select the option.

Note: To quickly scroll through the options press and hold \blacktriangledown or \blacktriangle .

To exit the options menu and return to normal operation at any time, press \bigcirc when the display reads:

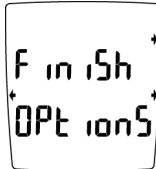

Latched Alarms Function

The detector is shipped with the latching alarm function disabled. If the low and high gas alarms are set to latch, the audible and visual alarms persist in the event of an alarm condition until the alarm is acknowledged by pressing \bigcirc .

To enable the latched alarm function, press \bigcirc when the display advises **LAtch in ALARMS**.



The display will advise latched alarm function is **on** (activated).



To disable latched alarms, repeat the sequence above. The display advises latched alarm is **OFF**.



“SAFE” Display Enable or Disable

When enabled, the Safe Display function advises that normal ambient conditions prevail and no gas hazard monitored exists. The word **SAFE** will scroll across the display when all gas levels are normal.

If any gas is present (readings other than zero for toxic gas or combustibles) and/or the Oxygen reading is other than 20.9%, the display will show gas levels for all sensors. When levels return to normal the display will read **SAFE**.

To enable the Safe Display function, press  when the screen reads **SAFE d ISPLAY**.



The screen will then advise that the Safe Display function is activated.



Repeat the above sequence to disable the Safe Display function. The display will advise the Safe Display function is **oFF**.

Combustible Sensor Measuring Selection

The detector is shipped with the combustible sensor set to measure and display combustible gases in the 0 to 100% LEL (lower explosive limit) range.

The detector can be set to measure and display methane in the 0 to 5.0% by volume range.

Note: *Percent by volume measurements apply to methane only.*

To change the combustible sensor's units, press  when the display reads **LEL SEn Un ItS**.



The screen then advises that LEL is now measured and displayed as percent by volume.



To change the sensor's units to percent LEL, repeat the sequence above.

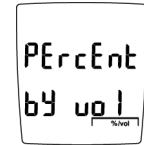

Language Selection

The detector is shipped with English as the displayed language. Multiple languages are available. To choose the desired language, press \blacktriangledown or \blacktriangle . Press \bigcirc to select the new language.

Sensor Enable or Disable

\triangle Warning

Disabling an installed sensor configures the detector to a 1, 2, or 3-gas unit. No protection is now provided for the gas targeted by that sensor(s).

Note: Disabling a sensor should be performed with extreme caution.

In the event a sensor fails, Sensor Disable can be used to turn off the sensor fail alarm. The sensor should be replaced and enabled as soon as possible.

The detector will function normally with remaining enabled sensors. The sensor may be enabled again, at any time.

To disable (or enable) the H₂S sensor, press \bigcirc when the display advises:

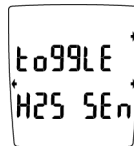

The display then advises the H₂S sensor is **OFF**.

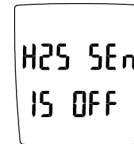

To enable the H₂S sensor, repeat the above sequence. The display advises H₂S sensor is **on**.

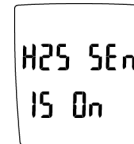

Repeat the sequence above for other sensors.

Note: If all the sensors are turned off the display will advise:
ALL SEnSorS ArE dISAbLED - ALL SEnSorS ArE rESEt to on.

Note: If a sensor is turned on through the display and the sensor is not installed in the detector the display will advise:
h2S SEnSor not InStALLED - SEnSor cAnnot BE EnAbLED

Pass Code Protection

The detector is shipped with Pass Code Protection off. Pass Code Protection prevents the user access to the User Option Menu and the Calibration menu (after Auto Zero). The key icon is lit on a pass code protected unit. 

To activate or deactivate Pass Code Protect

Enter the [User Option Menu](#) then press  when the screen displays **PASS Lock**.

The screen advises Pass Code Lock protection is **on** or **off** and beeps 2 times.

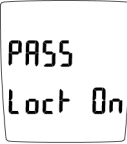
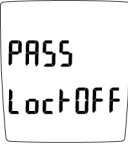

Pass Lock ON	Pass Lock OFF
	

To enter the pass code

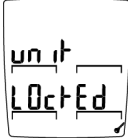

Note: Pass Code is provided separately.

If the detector is pass code protected, the display advises: **Unit Locked**. Enter the correct 3-digit code and press  to confirm entry.

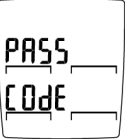
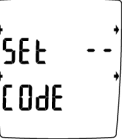
Note: The correct factory Pass Code must be entered within 10 seconds or the detector returns to normal operation.

Unit Locked	Please Enter Pass Code	PASS CODE	Enter Code
			

Pass code not entered or entered incorrectly

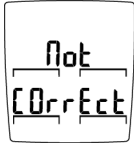
<p><i>No code entered or incorrect code entered and confirmed.</i></p> <ul style="list-style-type: none"> • Beeps • Returns to normal operation 	
<p><i>Code entered but not confirmed.</i></p> <ul style="list-style-type: none"> • Beeps • Returns to normal operation 	 

Automatic Oxygen Calibration Enable or Disable

The detector is shipped with the Automatic Oxygen Calibration at start up enabled.

To disable (or enable) automatic calibration, press \bigcirc when the display advises:



The display then advises the Oxygen automatic calibration is **OFF**.



To enable automatic calibration, repeat the sequence above. The display advises automatic calibration is **on**.



Set Span Concentration Values

Span concentration values can be modified.

Note: BW recommends that Span Concentration values be set between specific ranges. See the section "[Calibration and Setting Alarm Setpoints](#)".

To change the span concentration value, press \bigcirc when the display advises:



The display will advise you to input a new span concentration value. To change the value, press \blacktriangledown or \blacktriangle until the desired concentration is displayed. Press \bigcirc to confirm the value. The next span concentration will then be displayed.

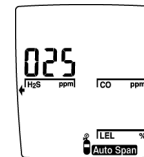

Note: If you do not press any pushbuttons within 10 seconds, the detector automatically forwards to the next span concentration.

If you change a span concentration but pause for 10 seconds before pressing \bigcirc , the detector will display **Err** and reject the new value.

STEL Calculation Period

The detector is shipped with the STEL calculation period set to 15 minutes. The period can be adjusted between 5 and 15 minutes.

To change the STEL calculation period, press when the display advises:

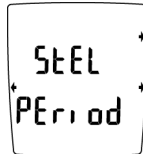

The display will advise you to input a new period. To change the value, press or until the desired period is displayed. Press to confirm the value.

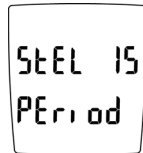

Note: If you do not press any pushbuttons within 10 seconds, the detector returns to the user option menu.

If you change a calculation period but pause for 10 seconds before pressing , the detector will display **StELErr** **PERiod** and reject the new value.

"Stealth Mode"

The detector is shipped with Stealth Mode disabled. Stealth Mode disables the speakers, backlight and alarm LEDs.

To enable (or disable) Stealth Mode, press when the display advises:



The display then advises that Stealth Mode is **on**.



To disable Stealth Mode, repeat the sequence above. The display advises Stealth Mode is **oFF**.



Change the Date and Time

Time and date adjustments apply only to detectors equipped with a User Downloadable Datalogger.

1. Set the time and date to your local time.

To set the real-time clock calendar, press when the display advises **AdJUST cLoCH**. To bypass this function, press and hold .



The items are set in this order:

- Minutes,
- Hours ^(h),
- Day of the week (*Monday = 1*),
- Date ^(D),
- Month ^(M),
- Year ^(Y).

Use and to adjust time and date. Press after each new setting.



Adjust Datalogger Sampling Rate

The detector is shipped with the datalogger set to record a sample every 5 seconds. The sample rate can be adjusted between 1 and 127 seconds.

To adjust the datalogger sampling rate, press when the screen reads **LOGGEr rAtE**.



The display will advise you to input a new sampling rate. To change the sampling rate, press or until the desired rate is displayed. Press to confirm the value.



Note: If you do not press any pushbuttons within 10 seconds, the detector returns to the user option menu.

Note: If you change the sampling rate but pause for 10 seconds before pressing , the detector will display **SEtErr IntEr** and reject the new value.

Alarms

Table 6 describes the detector alarms and shows how the display looks for each alarm.

Table 7 describes the computed gas exposures.

During an alarm condition, the detector activates the backlight and the display shows the current ambient gas reading.

If more than one type or level of alarm exists at the same time, a multi-gas alarm will result.

To change the factory-set alarm setpoints, refer to the section [“Calibration and Setting Alarm Setpoints”](#).

Table 6. Alarms

Alarms	Display	Alarms	Display
<p>Instant Low Alarm:</p> <ul style="list-style-type: none"> • Slow modulating tone and flash • ALARM and target gas bar flash • Vibrator Alarm activates 		<ul style="list-style-type: none"> • Instant High Alarm: • Fast modulating tone and flash • ALARM and target gas bar flash • Vibrator Alarm activates 	

Latching Alarm User Option: If the Latched Alarm function is activated, the audible and visual alarms continue to sound and flash until the alarm condition is acknowledged. To acknowledge latched alarms, press \odot . The alarms cannot be deactivated if an alarm condition is still present. To clear the TWA, STEL and maximum gas exposure readings, press \odot and \triangle simultaneously.

Table 6. Alarms (cont.)





Alarms	Display	Alarms	Display
<p>STEL Alarm:</p> <ul style="list-style-type: none"> Fast modulating tone and flash ALARM and target gas bar flash Vibrator Alarm activates 		<p>TWA Alarm:</p> <ul style="list-style-type: none"> Slow modulating tone and flash ALARM and target gas bar flash Vibrator Alarm activates 	
<p>Multi-Gas Alarm</p> <ul style="list-style-type: none"> Alternating Low and High Alarm tone and flash ALARM and target gas bars flash Vibrator Alarm activates 		<p>Over Range Alarm: (Over Level Exposure)</p> <ul style="list-style-type: none"> Fast modulating tone and flash ALARM and target gas bar flash Vibrator Alarm activates 	
<p>Sensor Alarm:</p> <ul style="list-style-type: none"> Slow modulating tone and flash ALARM and gas bar(s) flash Vibrator Alarm activates 		<p>Confidence Beep:</p> <ul style="list-style-type: none"> 2 fast beeps every 15 seconds. 	

Table 6. Alarms (cont.)

Alarms	Display	Alarms	Display
<p>Automatic Shutdown Alarm:</p> <ul style="list-style-type: none"> • 8 beeps and flashes •  LOW displays periodically • Vibrator Alarm temporarily activates 		<p>Normal Shutdown:</p> <ul style="list-style-type: none"> • 4 beeps and flashes • Vibrator Alarm temporarily activates 	
<p>Low Battery Alarm: (Confidence Beep disabled)</p> <ul style="list-style-type: none"> • 1 beep and 1 flash every 10 seconds •  LOW flashes 			

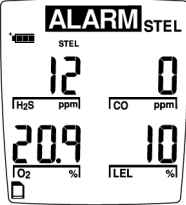
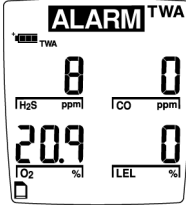
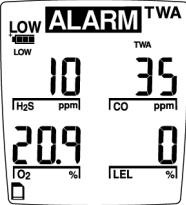
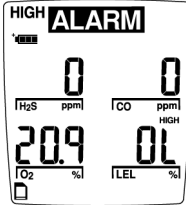
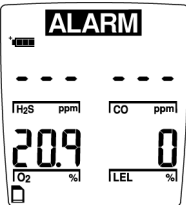
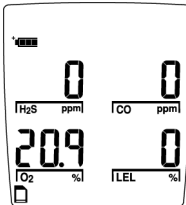
Gas Exposures Computed

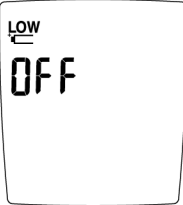
⚠ Warning

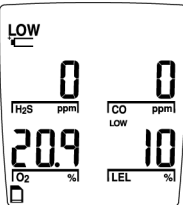
To avoid possible personal injury, do not turn off the detector during a work shift. TWA and STEL readings reset if the detector is left off for more than 5 minutes.

Table 7. Computed Gas Exposures

Gas Exposure	Description
TWA (CO, SO ₂ and H ₂ S only)	Time-weighted average based on an 8-hour workday. Accumulated value.
STEL (CO, SO ₂ and H ₂ S only)	Short-term exposure level based on a 5-15 minute period (user selectable). Accumulated value.
Maximum* (Peak)	Maximum gas exposures encountered during work shift.
* For Oxygen, maximum concentration encountered of either very high or very low levels.	

Viewing Gas Exposures

⇒ Press  until the display shows the TWA gas exposures:

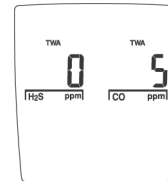

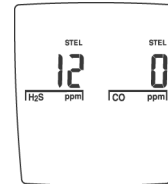

The display then shows the STEL gas exposures:

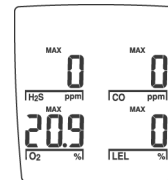

Then the maximum gas exposures:



To clear the TWA, STEL and maximum gas exposure readings, press  and  simultaneously.

Gas Alarm Setpoints

The detector's gas alarm setpoints trigger the gas alarms, which are described in Table 8.

Table 8. Gas Alarm Setpoints

Alarm	Condition
Low Alarm	<i>CO, H₂S, SO₂ and combustibles:</i> Ambient gas level above Low Alarm setpoint. (For O ₂ , see below.)
STEL and TWA Alarms (CO, SO ₂ and H ₂ S only)	Accumulated value above the STEL or TWA alarm setpoints
High Alarm	<i>CO, H₂S, SO₂ and combustibles:</i> Ambient gas level above High Alarm setpoint. (For O ₂ , see below.)
Multi-Gas Alarm	Two or more gas alarm conditions

Oxygen Alarm Setpoints: User-selectable for Low and High Alarms. Set both below, or both above, or one above and one below 20.9%, as desired

Resetting Gas Alarm Setpoints

Note: Standard factory alarm setpoints will vary by region.

Table 9. Sample Factory Set Alarm Setpoints

OSHA (Occupational Safety and Health Association) standard settings are used as an example.

Gas	TWA	STEL	Low	High
CO	35 ppm	50 ppm	35 ppm	200 ppm
H ₂ S	10 ppm	15 ppm	10 ppm	15 ppm
O ₂	N/A	N/A	19.5%	23.5%
Combustible Gases	N/A	N/A	10% LEL	20% LEL
SO ₂	10 ppm	15 ppm	10 ppm	15 ppm

To change the factory-set alarm setpoints, refer to the section "[Calibration and Setting Alarm Setpoints](#)".



Note: You can disable an alarm by setting the alarm setpoint to 0.

Stopping a Gas Alarm

The Low and High Alarms stop when the ambient gas level returns to the acceptable range.

Note: *If alarms are set to latch, press  to reset the alarms.*

The detector computes the TWA value based on an 8-hour workday, and the STEL alarm based on a 5 to 15 minute period (user selectable). See [“STEL Calculation Period”](#).

To clear the TWA, STEL and maximum gas exposure readings, press  and  simultaneously.

Sensor Alarm

The detector tests for a missing or defective sensor during the activation self-test. See the section [“If the Detector Does Not Work”](#).

Low Battery Alarm

The detector tests the batteries on activation and continuously thereafter. Battery power is continually displayed during normal operation. If the battery voltage is low, the detector activates the Low Battery Alarm.

The Low Battery Alarm continues until you replace the batteries or the battery power is almost depleted. If the battery voltage drops too low, the detector executes an Automatic Shutdown.

Automatic Shutdown Alarm

If the battery voltage is in immediate danger of dropping below the minimum operating voltage, the audible alarm beeps 8 times and the visual alarm flashes 8 times. After 3 seconds, the display blanks out and the detector stops normal operation. The display shows  **LOW** periodically until the battery power is depleted.

Replace the batteries. See the section [“Replacing the Batteries”](#).

Note: *If the Confidence Beep is ON, the audible alarm does not beep during a Low Battery alarm. See the section [“Confidence Beep”](#). Typically, the Low Battery Alarm continues for 30 minutes before Automatic Shutdown.*

Calibration and Setting Alarm Setpoints

Guidelines

When calibrating the detector, adhere to the following guidelines:

- Recommended gas mixture:
 - CO: 10 to 500 ppm balance N₂
 - H₂S: 10 to 100 ppm balance N₂
 - SO₂: 10 to 100 ppm balance N₂
 - LEL: 10 to 100% LEL or .5 to 5% by vol. Methane balance air
 - O₂: Clean Air, 20.9 %
- CG-Q58-4 and CG-Q34-4 Calibration Gas (4-gas mix) are available from BW Technologies. See the section [“Replacement Parts and Accessories.”](#)
- Calibration accuracy is never better than the calibration gas accuracy. BW Technologies recommends a premium-grade calibration gas. Gases with NIST (National Institute of Standards and Technology) traceable accuracy will improve the validity of the calibration. Do not use a gas cylinder beyond its expiration date.
- Calibrate a new sensor before use. Install the sensor, activate the detector, and allow the sensor to stabilize before starting calibration (used: 60 seconds; new: 5 minutes).
- Calibrate the detector on a regular basis, depending on use and sensor exposure to poisons and contaminants. BW recommends at least once every 180 days.
- Calibrate the detector if the ambient gas display varies at startup.
- It is best to calibrate the sensor before changing alarm setpoints.
- Calibrate only in a clean atmosphere that is free of background gas.
- To disable an alarm, set its alarm setpoint to 0.
- The combustible sensor is factory calibrated to 0 to 100% LEL using methane. If monitoring a different combustible gas in the 0-100% LEL range, calibrate the sensor using the appropriate gas.
- The Oxygen sensor can be automatically calibrated each time on activation, if this feature is enabled. Activate the detector in a normal (20.9% Oxygen) atmosphere.
- If you require a certified calibration, contact BW Technologies. See [“P.2”](#)

- The detector should be allowed to stabilize for 1 minute, after activation, prior to calibration or a bump test.

Diagnostics Protection

The detector tests the ambient air (Auto Zero) and the test gas applied (Auto Span) to ensure it meets expected values.

In Auto Zero, if any background target gas is present, the sensor(s) affected will read **Err** and exit the Auto Zero function, retaining the previous set value(s).

In Auto Span, if any target gas is not present or does not meet expected values, the display will advise you and exit calibration mode, retaining the previous set value(s).

Applying Gas to the Sensors

The calibration hose, which is shipped with the detector, simplifies sensor testing and calibration. Table 10 and Figure 3 show how to use it when applying gas to the sensors.

Table 10. Applying Gas to the Sensors

Item	Description
①	Detector and Calibration Cap
②	Calibration Hose
③	Regulator and Gas Cylinder

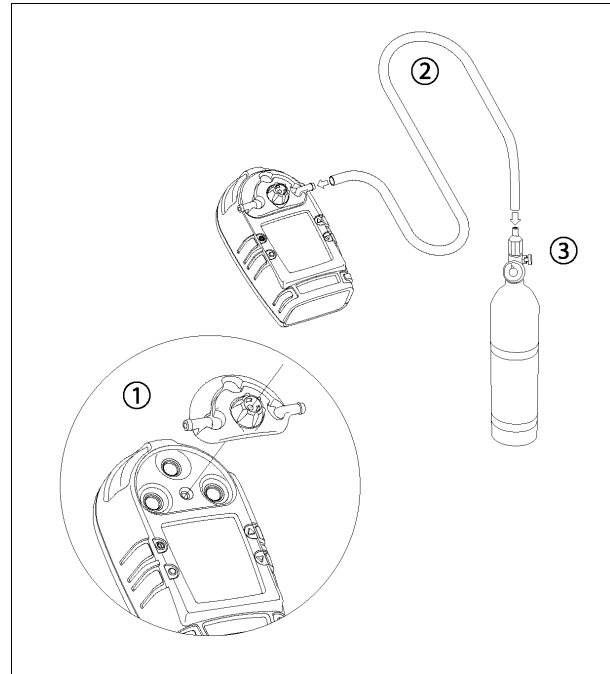



Figure 3. Applying Gas to the Sensors

Calibration Procedure



To calibrate the detector and set its alarm setpoints, perform the following:

Start Calibration

Note: To quit at any point after auto zero, press . The detector retains any saved values, and the audible alarm beeps 4 times before the detector returns to normal operation.

Note: At any point after auto zero but before calibration gas is detected, press  to bypass calibration and proceed to alarm setpoints.

Note: Verify that the calibration gas you are using matches the span concentration value(s) in the detector. See the section [“Set Span Concentration Values”](#).

1. In a clean atmosphere, press  and  simultaneously and hold for 5 seconds. The detector beeps 4 times and the display shows:

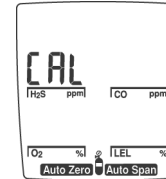

The audible alarm then beeps once signifying that calibration has begun.

Auto Zero and Oxygen Sensor Calibration

The display flashes **Auto Zero** while the detector automatically zeroes the toxic sensors and calibrates the Oxygen sensor.

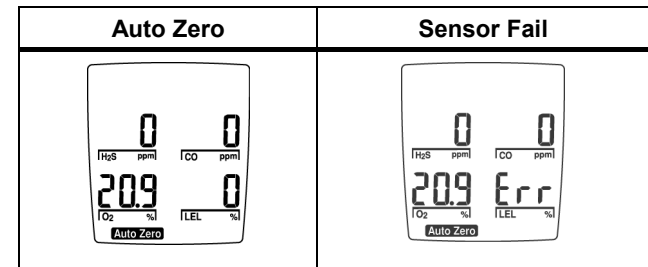

The audible alarm then beeps twice.

Note: Do not apply the calibration gas until the display shows ; otherwise, the auto zero step will fail.

Pass Code Protect: If the detector is pass code protected, after a successful Auto Zero, the detector will prompt for the pass code before proceeding to Auto Span and Alarm Setpoints.

See the section [“Pass Code Protection”](#).

Auto Span

Calibrate one, two, three or four sensors as desired.

The display shows , prompting you to apply a calibration gas to the sensor or skip the span (sensitivity adjustment):

2. Install the calibration cap and apply gas to the sensor at a flow rate of 250 to 500 ml/min. Or, press  now to skip the span.

When the detector senses approximately one-half of the expected gas concentration (30 seconds), the audible alarm beeps once. The detector then begins spanning the sensor(s) (2 minutes).

The audible alarm beeps 3 times at the end of the span. Remove the calibration gas.

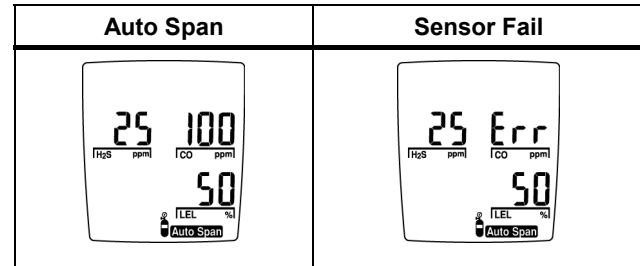

If a sensor fails, the display advises **Err** and skips the span for the failed sensor(s). Other sensors span normally. Press  to exit, and then restart calibration in an atmosphere that is clear of the targeted gases. If the auto zero fails a second time, restart the detector to test the sensors.

Note: *The detector will not span a sensor if:*

- You do not apply gas to the sensor.
- The sensor fails to detect at least one-half of the expected gas concentration in the first 30 seconds.
- The gas concentration drops below one-half of the expected gas level during the 2 minute span.

If you apply gas to a sensor and the detector fails to span the sensor, repeat the calibration process using a new gas cylinder. If the sensor fails the span a second time, replace

the sensor. See the section [“Replacing a Sensor or Sensor Filter”](#).

If the span adjustment is an unusually large (more than 20 %), the detector will advise: **note: SPAN ADJUST UNUSUALLY LARGE - CHECK THAT THE CAL GAS IS CORRECT.**

Confirm that the calibration gas bottle you are using is correct and that the span concentration value(s) in the detector match the value of the calibration gas bottle. See [the section “Set Span Concentration Values”](#)

If the calibration adjustment is expected accept the calibration.

Span Adjustment	Accept/Reject

If a span is rejected, the display advises: **note: SPAN REJECTED** and skips the span for the failed sensor(s).

Alarm Setpoints

Alarms may be set anywhere within the detection range for the sensor. See the section [“Specifications”](#) or set to zero for off.

Factory alarm setpoints may vary by region. An example is given below. Set as desired.

H ₂ S	TWA: 10 ppm STEL: 15 ppm LOW: 10 ppm HIGH: 15 ppm
CO	TWA: 35 ppm STEL: 50 ppm LOW: 35 ppm HIGH: 200 ppm
O ₂	LOW: 19.5% HIGH: 23.5%
Combustible	LOW: 10% LEL HIGH: 20% LEL
SO ₂	TWA: 10 ppm STEL: 15 ppm LOW: 10 ppm HIGH: 15 ppm

Note: If you do not press any pushbuttons within 10 seconds, the detector automatically retains the previous alarm setpoint.

If you change an alarm setpoint but pause for 10 seconds before pressing \bigcirc , the detector will display **Err** and reject the new value.

Setting the TWA Alarm Setpoint

The display shows the TWA alarm setpoint for H₂S.

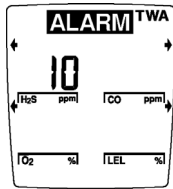

3. To change the TWA Alarm setpoint for this sensor, press \blacktriangledown or \blacktriangle until the display shows the new value. Press \bigcirc to save the displayed value.

Setting the STEL Alarm Setpoint

The display shows the STEL Alarm setpoint for H₂S:

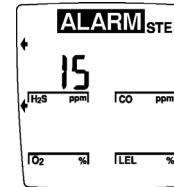

4. To change the STEL Alarm setpoint for this sensor, press \blacktriangledown or \blacktriangle until the display shows the new value. Press \bigcirc to save the displayed value.

Setting the LOW Alarm Setpoint

The display shows the Low Alarm setpoint for H₂S:

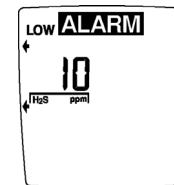

5. To change the Low Alarm setpoint for this sensor, press \blacktriangledown or \blacktriangle until the display shows the new value. Press \bigcirc to save the displayed value.

Setting the HIGH Alarm Setpoint

The display shows the High Alarm Setpoint for H₂S:

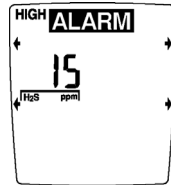

6. To change the High Alarm setpoint for this sensor, press \blacktriangledown or \blacktriangle until the display shows the new value. Press \bigcirc to save the displayed value.

Setting the Remaining Alarm Setpoints

7. Repeat steps 3 through 6 to set alarm setpoints for the other sensors. The audible alarm will beep 4 times when the alarm setpoint function is complete.

Setting the Calibration Due Date

After a successful calibration, the display shows the number of days remaining before calibration is due.

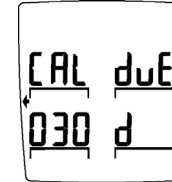

To change the calibration due date (1 to 365 days), press \blacktriangledown or \blacktriangle until the display shows the new value. Press \bigcirc to save the displayed value. The detector will beep five times and then return to normal operation. To disable the calibration due date, press \blacktriangledown or \blacktriangle until the display shows ---. Press \bigcirc to save the displayed value.

If you do not press any pushbuttons within 10 seconds, the detector automatically retains the previous calibration due date.

If calibration is unsuccessful, the detector will advise:
note: cAL ALL SenSorS to rESEt cAL dUE dAtE.

Verification (optional)

Test the detector using a gas cylinder other than the one used in the calibration steps. The gas concentration should not exceed the sensor's detection range. Confirm that the display shows the expected concentration.

Maintenance

To keep the detector in good operating condition, perform the following basic maintenance as required:

- Calibrate, bump test and inspect the detector at regular intervals.
- Keep an Operations Log of all maintenance, calibrations, bump tests and alarm events.
- Clean the exterior with a soft damp cloth. Do not use solvents, soaps or polishes.
- Do not immerse the detector in liquids.

Replacing the Batteries

⚠ Warning

To avoid personal injury:

- ⇒ **Replace the batteries as soon as the detector emits a Low Battery Alarm.**
- ⇒ **Use only batteries recommended by BW Technologies to prevent damage or personal injury.**
- ⇒ **Use only approved batteries, properly installed in the detector case. See the section "[Specifications](#)" for approved batteries.**
- ⇒ **Charge batteries using only a recommended charger. Do not use any other charger. Failure to observe this precaution could lead to fire or explosion.**
- ⇒ **Do not change or charge batteries in a hazardous location. Doing so will impair the intrinsic safety of the unit, and may lead to fire or explosion.**

Table 11 and Figure 4 illustrate how to replace the batteries. If the detector is on, turn it off. Press the two release buttons on the detector. The battery tray pulls out and snaps in.

Remove the batteries from the battery tray and replace according to the polarity markings. Close the tray until you hear both sides click, which locks the battery tray in place.

Table 11. Replacing the Batteries

Item	Description
①	Detector Front
②	Release Buttons
③	Batteries
④	Battery tray

To preserve battery life, turn off the detector when you are not using it.

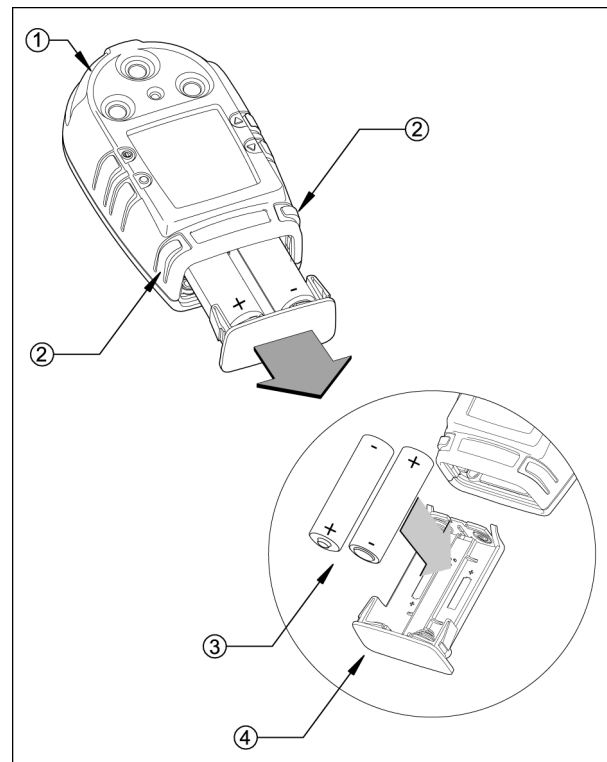

Figure 4. Replacing the Batteries

Replacing a Sensor or Sensor Filter

⚠ Warning

To avoid personal injury, use only sensors specifically designed for the detector. See the section [“Replacement Parts and Accessories.”](#)

Each sensor has a high degree of resistance to common vapors and gases. A sensor will most likely clear itself if you remove the detector to a clean environment and wait 10 to 30 minutes. Do not expose a sensor to the vapors of inorganic solvents (such as paint fumes) or organic solvents. The section [“If the Detector Does Not Work”](#) describes problems caused by a sensor in need of calibration or replacement.

Table 12 and Figure 5 illustrate how to replace a sensor or sensor filter. If the detector is on, turn it off. Remove the battery tray (see Figure 4). Remove the machine screw and alligator clip. Remove the (two) thread cutting screws on the rear shell and remove the shell. Remove the (four) thread cutting screws on the PCB assembly and extract the PCB.

Replace the sensor filter or replace the sensor(s).

Gently rocking the sensor back and forth may help free a tightly held sensor. Insert a new sensor on the PCB, ensuring that sensor posts are aligned correctly.

Note: Detectors that are configured for 1, 2 or 3 gases may contain a dummy sensor in one of the three sensor locations.

Re-assemble the detector.

Calibrate the detector after changing any sensor(s). See the section [“Calibration and Setting Alarm Setpoints”](#).

Table 12. Replacing a Sensor or Sensor Filter

Item	Description
①	Front shell
②	Triple sensor filter
③	Oxygen Sensor (sensor 3)
④	LEL Sensor (sensor 2)
⑤	CO/H ₂ S Sensor (sensor 1)
⑥	Sensor locator
⑦	PCB assembly
⑧	Rear shell
⑨	Alligator clip
⑩	Machine screw
⑪	Thread cutting screws

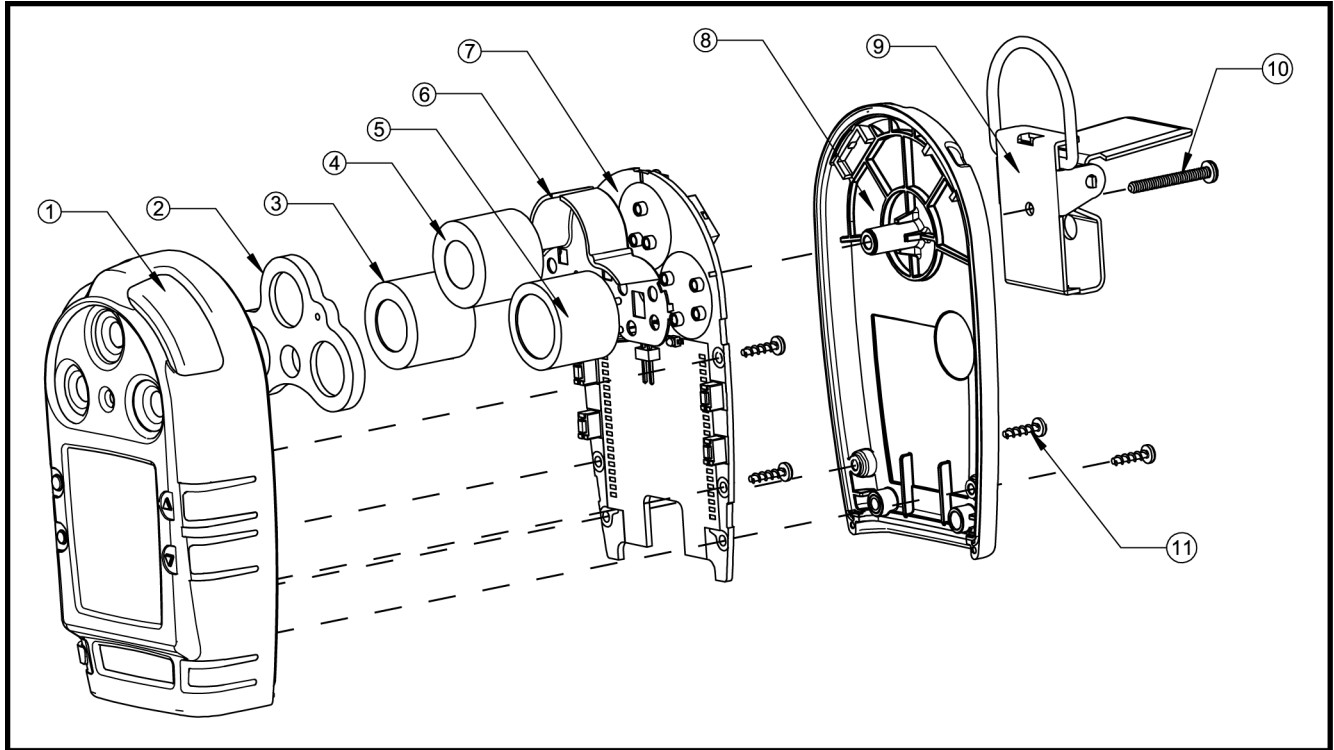

Figure 5. Replacing a Sensor or Sensor Filter

Installing the MultiMediaCard (MMC)

Figure 6 illustrates how to install the MMC. If the detector is on, turn off the detector. Remove the battery tray (see Figure 4). Slide the MMC face down into the MMC port and replace the battery tray.

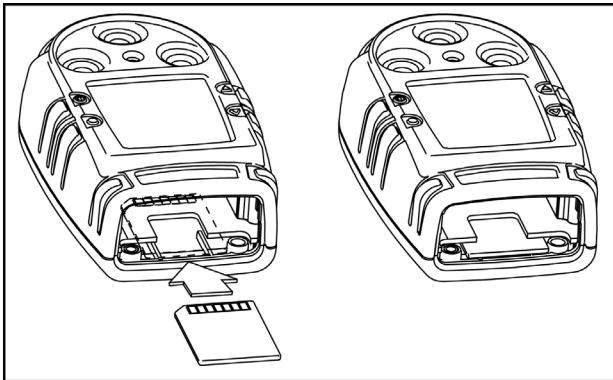

Figure 6. Installing the MultiMediaCard (MMC)

If the Detector Does Not Work

The detector's electronics are protected from variations in humidity and corrosive atmospheres. If you encounter a problem, try the solutions listed in the following table.

If you are still unable to correct the problem, contact BW Technologies ([see P.2](#))

Table 13. Troubleshooting Tips

Problem	Possible Cause	Solution
Detector does not turn on.	No batteries. Depleted batteries. Damaged or defective detector.	→ Install batteries. See the section " Replacing the Batteries. " → Replace batteries. See the section " Replacing the Batteries. " → Contact BW Technologies (see P.2)
Detector enters alarm immediately when turned on.	Sensor needs to stabilize. Low Battery Alarm. Sensor Alarm.	→ Used sensor: wait 60 seconds New sensor: wait 5 minutes → Replace batteries. See the section " Replacing the Batteries. " → Replace sensor. See the section " Replacing a Sensor or Sensor Filter. "
Activation self-test fails during one of the first five steps.	General fault.	→ Contact BW Technologies (see P.2)

Table 13. Troubleshooting Tips (cont.)

Problem	Possible Cause	Solution
<p>Detector does not display normal ambient gas reading after activation self-test.</p>	<p>Sensor not stabilized. Detector requires calibration. Target gas is present.</p>	<p>→ Used sensor: wait 60 seconds New sensor: wait 5 minutes → Calibrate detector. See the section "Calibration and Setting Alarm Setpoints". → Detector is operating properly. Use caution in suspect areas.</p>
<p>Detector does not respond to pushbuttons.</p>	<p>Batteries are depleted. Detector is performing operations that do not require user input.</p>	<p>→ Replace batteries. See the section "Replacing the Batteries." → Pushbutton operation restored automatically when the operation ends</p>
<p>Detector does not accurately measure gas.</p>	<p>Detector requires calibration. Detector is colder/hotter than ambient gas. Sensor filter is blocked.</p>	<p>→ Calibrate sensor. See the section "Calibration and Setting Alarm Setpoints." → Allow the detector to acquire ambient temperature before use. → Clean the sensor filter. See the section "Replacing a Sensor or Sensor Filter."</p>

Table 13. Troubleshooting Tips (cont.)

Problem	Possible Cause	Solution
Detector does not enter alarm.	Alarm setpoint(s) are set incorrectly. Alarm setpoint(s) set to zero. Detector is in calibration mode.	<ul style="list-style-type: none"> → Reset alarm setpoints. See the section "Calibration and Setting Alarm Setpoints." → Reset alarm setpoints. See the section "Calibration and Setting Alarm Setpoints." → Complete the calibration procedure.
Detector intermittently enters alarm without apparent reason.	Ambient gas levels are near alarm setpoint or the sensor is exposed to a puff of the target gas. Alarms set incorrectly. Missing or faulty sensor.	<ul style="list-style-type: none"> → Detector is operating normally. Use caution in suspect areas. Check maximum gas exposure reading. → Reset alarm setpoints. See the section "Calibration and Setting Alarm Setpoints." → Replace sensor. See the section "Replacing a Sensor or Sensor Filter."
Detector automatically shuts off.	Automatic Shutdown feature activated due to weak batteries.	<ul style="list-style-type: none"> → Replace batteries. See the section "Replacing the Batteries."
Detector displays intERnAL cLoCK HAS FR ILed	General fault	<ul style="list-style-type: none"> → Contact BW Technologies (see P.2)

Replacement Parts and Accessories

⚠ Warning

To avoid personal injury or damage to the detector, use only the specified replacement parts.

To order parts or accessories listed in Table 14, contact BW Technologies ([see P.2](#))

Table 14. Replacement Parts and Accessories

Model No.	Description	Qty
S4-W04	Replacement combustible sensor	1
S4-W04-SF	Replacement combustible sensor (with silicone filter)	1
SR-X10	Replacement O ₂ (2-year) sensor	1
D4-RHM04	Replacement Twin Tox H ₂ S/CO sensor	1
PS-RH04S	Replacement H ₂ S sensor (-3H units only)	1
PS-RS04	Replacement SO ₂ sensor	1
GAMIC-SS	Triple sensor filter replacement	2
CG-Q58-4	Quad calibration gas (58 L) (CH ₄ -2.5%, O ₂ -18.0%, H ₂ S-25 ppm, CO-100 ppm, bal.N ₂)	1
CG-Q34-4	Quad calibration gas (34 L) (CH ₄ -2.5%, O ₂ -18.0%, H ₂ S-25 ppm,	1

Model No.	Description	Qty
	CO-100 ppm, bal.N ₂)	
CG-T34	Two Gas Calibration cylinder 50% LEL (CH ₄ -2.5%) O ₂ - 20.9%, bal. N ₂ -34 litre	1
CG-S25	GAS-CAL SO ₂ 25PPM BAL N ₂ 58L	1
CG-BUMP-S25	SO ₂ bump test gas	1
CG-BUMP1	BUMP Alarm Gas Aerosol (CH ₄ -2.5%, O ₂ -10%, H ₂ S-40 ppm, CO-200 ppm)	1
REG-0.5	Regulator (0.5 L/min)	1
CK-Q34-4	Quad Calibration Kit with regulator, quad gas cylinder (CG-Q34-4), hose and carrying case	1
CK-Q58-4	Quad Calibration Kit with regulator, quad gas cylinder (CG-Q58-4), hose and carrying case	1
CR-MMC-FD1	FlashPath MMC Card Reader (3 1/2" Floppy Disk Adapter)	1
CR-MMC-USB1	MMC USB Reader (USB Port) with software for user-downloadable datalogger (-DL2)	1
MMC32	32 MB MultiMediaCard	1
MMC64	64 MB MultiMediaCard	1

Model No.	Description	Qty
GAMIC-C01-K	Kit of 4 AA NiMH rechargeable batteries and 110 VAC 4-port charger, American plug type)	1
GAMIC-C01-K-(xx)	230 VAC 4-port charger* and 4 AA NiMH batteries	1
GAMIC-C02	SMART Charger - 10-port, 110 VAC, American plug type	1
GAMIC-C03	GA MicroBatt Charger (cradle charger)	1
GAMIC-C03-K	GA MicroBatt Charger Kit with Battery Pack (GAMIC-BAT-03)	1
GAMIC-V-CHRG1	Vehicle Charger - 4-port, 12 volt with 4 AA NiMH rechargeable batteries	1
GAMIC-BAT-K	Rechargeable AA NiMH batteries, 1800 mAh, kit of 4 (not applicable for Europe)	1
GAMIC-BAT-K2	Rechargeable AA NiMH batteries, 1600 mAh, kit of 4	1
GAMIC-BAT-03	GA MicroBatt Battery Pack (GAMIC-C03)	1
GA-HMIC	Belt Holster for GasAlertMicro	1
GA-HMIC-SP	Holster Kit for GasAlertMicro and Sampler	1

Model No.	Description	Qty
GA-CH-2	Chest Harness	1
GA-ES-1	Extension Strap	1
GAMIC-TC-1	Calibration cap (standard)	1
GAMIC-TC-2	Calibration cap (single barb) for use with manual aspirator pump	1
GAMIC-AG2	Alligator Clip (stainless steel)	1
GAMIC-CK-CC1	Carrying case with foam for GasAlertMicro Confined Space Kits	1
GA-SPAK	SamplerPak, motorized sampling pump portable kit	1
GAMIC-DOCK-1	MicroDock Automatic test and calibration station Basic System - 1 Docking Module	1
GAMIC-MOD	GasAlertMicro Docking Module	1
GAMIC-DOCK-2	Portable System Kit - 1 Docking Module, 34 L calibration gas (hard sided carrying case)	1
GAMIC-DOCK-3	Portable System Kit - 2 Docking Modules, 58 L calibration gas (heavy duty waterproof case)	1
D4-AS01	Manual Aspirator Pump with 10 ft./3 m hose	1
GA-AS02	Manual Aspirator Pump with 1	1

Model No.	Description	Qty
	ft./0.3 m probe	
GA-TPROB6	Telescopic Sample Probe (6.5 ft./2 m)	1
M2437K	Battery lock screw, kit of 10 (applicable only for –UK, -EU and –AU detectors)	1

**Add suffix (-UK) for United Kingdom mains plug, (-EU) for European mains plug, (-AU) for Australian mains plug.*

Specifications

Instrument Dimensions: 6 x 10 x 3.3 cm (2.4 x 4.0 x 1.3 in.)

Weight: 211 g (7.4 oz.)

Operating Temperature: -20 °C to +50 °C (-4 to +122 °F)

Storage Temperature: -20 °C to +50 °C (-4 to +122 °F)

Operating Humidity: 5% to 95% relative humidity (non-condensing)

Operating Pressure: 95 to 110 kPa

Alarm Setpoints: May vary by region and are user-settable.

Detection Range:

CO: 0-500 ppm in 1 ppm increments

H₂S,SO₂: 0-100 ppm in 1 ppm increments

O₂: 0-30% in 0.1% increments

Combustibles: field settable for:

0-100% LEL in 1% LEL increments or

0-5.0% v/v methane in .1% increments

Sensor Type:

H₂S/CO: Twin plug-in electrochemical cell

O₂,SO₂, H₂S, CO Single plug-in electrochemical cell

Combustibles: Plug-in catalytic bead

O₂ Measuring Principle: Capillary controlled concentration sensor

Alarm Conditions: TWA Alarm, STEL Alarm, Low Alarm, High Alarm, Multi-Gas Alarm, Sensor Alarm, Low Battery Alarm, Confidence Beep, Automatic Shutdown Alarm

Audible Alarm: 95 dB at 1 ft (0.3 m) variable pulsed dual beepers

Visual Alarm: Dual red light-emitting diodes (LED)

Display: Alphanumeric liquid crystal display (LCD)

Backlight: Automatically activates whenever there is insufficient light to view the display and during alarm conditions

Self-test: Initiated at activation

Calibration: Automatic Zero and Automatic Span

Oxygen Sensor: Automatic Span on activation

User Field Options: Confidence Beep, Latching Low and High Alarms, Pass code protection, enable/disable "SAFE" display mode, Combustible sensor measurement (0-100% LEL or 0-5.0% v/v methane), Sensor Disable, set calibration due date, TWA and STEL, Stealth mode, language selection, Enable/disable automatic Oxygen calibration, Set Span concentration values, Set STEL calculation period. Datalogger models only Adjust clock calendar and Set sampling rate.

Approved Batteries:

North America

Approved batteries for product (standards EN50020, UL913, C22.2 No. 157)

<i>Alkaline:</i>	Temperature Code
Duracell MN1500	T3C (139.8°C)
Energizer E91	T3B (163°C)

NiMH rechargeable:

Quest Platinum HGAAC1800G	T2 (211.4°C)
Quest HG1600AACS	T3 (199°C)
Energizer NH15	T2D (205°C)
Maha Powerex 1700 mAh MH-AA170	T3 (192°C)
Maha Powerex 1800 mAh MH-AA180	T2D (201.1°C)
Yuasa Delta 1300 mAh DHA1400AA	T2D (209°C)
Yuasa Delta 1500 mAh DHA1600AAC	T2D (204.4°C)
Uniross 1300 mAh	T3 (198°C)
Uniross 1700 mAh	T3 (186.8°C)

GA MicroBatt:

GAMIC-BAT-03	T4 (120°C)
--------------	------------

Worst case temperature code:

Alkaline :	163°C
NiMH:	212°C
GA MicroBatt:	120°C
Ambient:	-20°C ≤ Ta ≤ +50°C

Europe

Approved batteries for product (standards EN50020)

Alkaline:

Duracell MN1500	T4 (129.8°C)
-----------------	--------------

NiMH rechargeable:

Quest HG1600AACS	T3 (189°C)
Ambient:	-20°C ≤ Ta ≤ +40°C

GA MicroBatt:

GAMIC-BAT-03	T4 (120°C)
Ambient:	-20°C ≤ Ta ≤ +50°C

Battery Charger (optional): Quest™ Q2 4-port rapid NiMH battery charger with country-specific mains adapter

First-time Charge: 1-4 hours per battery

Normal Charge: 1 hour per battery

Approvals: Approved by CSA to both U.S. and Canadian Standards.

Approved: Class I, Division 1, Group A, B, C, and D; Class I, Zone 0, Group IIC

Standards: CAN/CSA C22.2 No. 157 and C22.2 152 ANSI/UL – 913 and ANSI/ISA –S12.13 Part 1

CE (LCIE): EEx ia d IIC ATEX  II 2 G

ATEX: 03 ATEX 6091X

ABS Type Approved: VA-348-169-X

General Specifications for Datalogger Units

Media Type: MMC (MultiMediaCard)

Size: 32 MB (standard); 64 and 128 MB cards available

Storage: 500,000 lines of data available; 4.4 months at 5 second intervals (based on a normal workweek)

Memory Type: Wrap-around memory ensures most recent data is always saved

Sample Rate: One reading every 5 seconds (standard)

Data Recorded: All sensor readings, all alarm conditions, calibrations, event flags, battery status, sensor status, confidence beep activation, and detector status along with the time and date for each reading and unit serial number

MMC Card Test: Automatically on activation

GasAlertMicro with User Downloadable Datalogger

Operation: Requires no user intervention (automatic)

Indicators: Icon advises Datalogger is operating normally, MMC card missing/malfunction advise

Compatible with: Desktop PC Computer or Laptop

Operating System: Windows 95 or higher; Macintosh OS 8.6 or higher

Download via: MMC card reader.

Software Required: Spreadsheet or database compatible with comma-separated-value (CSV) text files (Excel, Access, Quattro, etc.)

Card Alarm: MMC Card Fail or Missing

Support:

BW E.D.M (Excel Datalog Manager): E.D.M. is an Excel software add-in that enhances the abilities of Microsoft® Excel when handling GasAlertMicro User Downloadable Datalogger data files.

Appendix A

Excel Datalog Manager (E.D.M.)

The Support CD for the User Downloadable Datalogger Detectors contains:

- BW Technologies' Excel Datalog Manager (E.D.M.) software plug-in.
- Installation and Use instructions
- Datalogger example data files and spreadsheets.

IMPORTANT

E.D.M. Review and use the CD Help and Sample files for installing and using the E.D.M. program.

Excel: All functions and features of Microsoft® Excel are available, including automatic graphing. Use Excel Help to sort, format and archive data easily and automatically.

Excel Datalog Manager (E.D.M.) Software Plug-in

Data import is fully automated and allows Excel to load files larger than 65,535 lines. The E.D.M. program will automatically create additional worksheets for larger files.

System Requirements

Recommended E.D.M. system: 750 MHz Pentium (or equivalent), 100 MB hard disk space, Microsoft® Windows 2000, Microsoft® Excel 2000

Minimum E.D.M. system requirements: 300 MHz Pentium (or equivalent), 30 MB free hard disk space, Windows 95, Microsoft® Excel 95

Sample Data Files

Sample data is available on CD. Sample data files help you become familiar with the software.

Files with the .CSV extension are samples of actual data files downloaded from a detector. CSV files may be imported into Excel using the E.D.M. wizard or loaded directly into Excel or a compatible database, spreadsheet or word processor.

Installing Excel Datalog Manager (E.D.M.):

- Place the Datalogger E.D.M. Support CD in the middle of the CD-ROM tray and close.
- **AutoPlay:** From the main window, click on the “Excel Datalog Manager” button. Then click on the “install E.D.M.” the installation wizard will guide you.
- **AutoPlay not Activated:** In "My Computer," find the E.D.M. icon on your CD drive.



Double click the E.D.M. icon to select the drive. Then, double click the file “EDM_Setup_v###.exe”. Now the installation wizard will guide you.

After setup is complete and you have restarted your computer, you will find a new item, called **BW Technologies**, listed in your start menu. This item contains:

- E.D.M. Help – (Use instructions & Help information)
- Excel Datalog Manager (Starts the Excel Datalog Manager software)

MMC Card Reader Installation

To retrieve recorded data, a MultiMediaCard reader has to be configured and installed to your computer. The adapter provides the physical connection between the MultiMediaCard and your computer. Follow manufacturer’s instructions.

Ensure your card reader is compatible with your computer. Several card readers that support Windows are available from BW Technologies.

Types of MultiMediaCard Readers

MultiMediaCard readers are available in 2 types:

- Universal Serial Bus (USB); or
- PCMCIA (PC card) adapters.

Start Excel Datalog Manager

Double click on the E.D.M. icon on the desktop to start the Excel Datalog Manager Wizard. This provides a simple method of transferring data from the datalogger system to Microsoft® Excel.



Import Your Data File.

After starting the E.D.M. wizard, follow the easy steps:

1. Start: Click “Next” to begin the data file import.



2. File Location: Click “Browse” to locate your data file. Once located, highlight the file and click “Open’,” then “Next” to move to the next option.



Data files may be imported from the hard disk, or directly from the MultiMediaCard containing the data. The import process does not modify or erase the original data.

3. Archive Back-up of Data File:

This option enables you to create a complete backup copy of the original card data. Click the checkbox to enable archiving then click the “**Browse**” button to select the location to place the backup data file. *Once finished, click “Next.”*



Back-ups can be loaded into Excel or other compatible programs at any time.

4. Location of Final File: Use this step to select the location of the finished Excel data workbook. The data file will be sorted, imported into Excel, formatted, and saved as an Excel workbook file. *Once finished, click “Next.”*



5. Filter: This step allows the user to filter the original files down to a convenient, manageable size without losing any critical information.

Select “**include all records**”, or select to include only every second, third, etc., entry without losing any critical information.

Once finished, click “**Next**”.

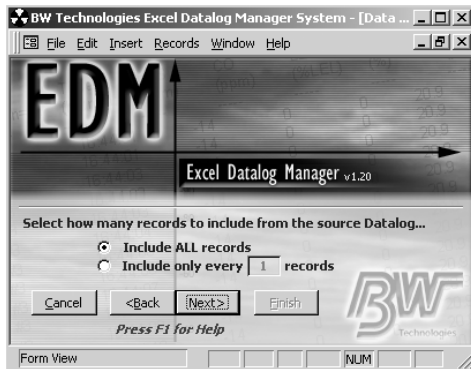

Note: This option does not remove or delete data from the original data file or any archived file; only the final Excel workbook is affected.

ALL Records involving alarm conditions, failures, calibrations, battery warnings or other important events will not be filtered and will appear in the final Excel Workbook in their entirety. If the confidence beep is used on the datalogging instrument, this step has no effect; E.D.M. will not filter out records where the confidence beep is active.

6. Finish: Click “**Finish**” to import the data into Excel and open the finished Excel data workbook.



Note: The data file may take several minutes to transfer, read and sort in E.D.M.

E.D.M. Workbook Features and Functions

The customized Excel workbook created by the E.D.M. wizard provides the datalogger data in a preformatted layout. Several automatic features and functions are available to simplify the data management process, such as color-coding, data filtering and automatic charting.

Data workbook format

Titles and worksheets

The workbook is titled according to the instrument type used to collect the data. The title is shown at the top of the data file, i.e. "GasAlertMicro data file".

Each workbook will contain as many sheets as is necessary to hold all of the imported data. Excel has a built-in limit of 65,535 lines per worksheet. Since datalogger files may include up to 2,100,000 lines of information, the information is split across several worksheets in the same workbook when required.

Sheets are named according to the serial number of the instrument used to record the data. If there is more than one sheet for a given instrument, the sheet names will be appended with -1, -2, and so on, as in '123456-1', '123456-2' etc.

Type and order of displayed data

Data is presented in chronological order by date. The day of the week and the instrument serial number is also presented, followed by the instantaneous gas readings and time weighted-average (TWA) readings as calculated by the instrument.

Status messages for each sensor are also shown. These messages indicate if the sensor is operating normally, or has some type of alarm, failure or condition that is different from normal operation. Possible conditions include low alarm, high alarm, TWA alarm, calibration, last calibration, alarm setpoints and sensor self-test failure. Status codes for the sampling pump (if present), data logger, instrument battery and instrument alarms are also shown.

Sensor readings that exceed the alarm points are highlighted in color. Yellow shading indicates low alarm conditions. Red shading indicates high or TWA alarm conditions.

Overlapping or older data

Because the data is sorted by date & time, the data file will not contain overlapping data unless the internal clock settings of the datalogger instrument have been changed.

In most cases, data files will contain data that has been previously downloaded from the card. This is a consequence of the large data storage capacity of the MultiMediaCard

flash memory, and of the nature of the datalogger operation. The card will generally contain data from the previous 300 hours of operation.

In some cases, depending on use, the data file may contain fragments of data that are older than the last 300 hours of use. This is a normal consequence of the datalogger operation and is not a sign of malfunction. The data is not automatically deleted because the software cannot determine if the data is important or not. If desired, the older data may be easily deleted or filtered out using the built-in features of the spreadsheet

Working with the data

Data in the Excel workbook can be manipulated using Excel's built-in functions. Excel supports search, search and replace, sorting and many other data handling functions.

There are also several built-in features that will help automate and simplify routine data management tasks.

Entering user data or comments

There is a general comment field at the top of each worksheet that may be used to enter user information about the logger data. This general comment field is automatically mirrored to the other associated worksheets in the workbook, so the comments need only be entered once.

Changing or removing the preformatted cell color-coding

Gas readings are color-coded according to alarm conditions. If you wish to remove change or the color coding, select the 'Conditional formatting' option under the 'Format' menu.

To change the color-coding to a new system, enter new rules in the 'Condition' boxes. You may also change the format of the cells that match the rules by pressing the 'Format' buttons. Refer to Excel help for more information on creating and using conditional formatting.

To delete the color-coding, press 'Delete', check all of the checkboxes, and press OK. This will remove the rules that Excel is using to determine if the cell should be shaded or not.

Sorting: Reorganizing the data

The worksheet data is normally shown in chronological order. To re-sort the data, select the appropriate rows and select 'Sort' from the 'Data' menu.

When sorting data, ensure that you select complete rows. If you do not, the sensor readings may no longer correspond to the correct time & date.

Filtering: Restricting the viewed data by date, gas reading or status code

Data managers often wish to view only events that occur within a specific time frame, exceed a certain gas or accumulated TWA level, or some other particular set of conditions. The EDM workbook provides automatic filters that automate this task.

To filter the displayed data on any column, click on the down arrow icon present in the column header. A list of filtering choices is then presented. Either select one of the displayed choices, or 'Custom' to define new filtering criteria.

Filters may be applied to several columns at once to further narrow down the viewed data. Filters may also be applied to status fields, so that events such as pump failures, instrument calibrations and low-battery warnings can be easily pinpointed.

Data is not lost or removed from the worksheet when filters are used. To view all of the available data, re-select the filtered columns and click 'All'. You may have to do this for several columns before all of the data appears if several filters are in use at the same time.

Examples:

- To restrict by date: Choose 'Custom' from the date & time header. In the dialog box that appears, click on the down arrow icon for the top left-hand box, and select 'is greater than or equal to'. Click on the down arrow for the top right-hand box, and select the start date. Repeat this process for the other boxes, selecting 'is less than or equal to' and the end date.

Note: *dates that do not appear in the current worksheet will not be displayed.*

- To restrict by gas level: Choose 'Custom' from the relevant gas. In the dialog box that appears, select the ranges you wish to view for that gas. Note: gas levels that do not appear in the current worksheet will not be displayed, but may be typed in manually. You may repeat this for other gases to further restrict the viewed data.

Note: *The filtering process may take some time to complete on slower machines, or on larger data files.*

Charting: Automatically charting the data

Data for the active worksheet may be charted by pressing the 'Chart Data' button at the top of the worksheet. Data for the current sheet will be graphed and displayed as a new chart sheet. The chart sheet is automatically named according to the worksheet that was charted.

To chart a section of data, use the data filters (described above) to restrict the data display to the section or type of data you are interested in. Pressing the 'Chart Data' on filtered data will chart only the data being displayed at that time. This allows automatic charting of any data subset required.

Charting: Manually charting the data

Data that is split between worksheets cannot be charted automatically. To chart data that is split between two worksheets, copy the data in question from the two sheets to a new worksheet. Note that Excel has a built-in limit of 65,535 lines per worksheet.

To successfully chart the data, it is necessary to split the 'Date & Time' column into two columns. This is necessary because Excel does not correctly interpret the combined date and time.

The simplest method to do this is to make two copies of the date & time column beside each other. Reformat column 1 to 'Date' using the 'Format cells' command, and reformat column 2 to 'Time'. You then may select the data you wish to graph and use the Excel Chart Wizard to create the graph of your choice. For more information on the Chart Wizard, refer to Excel help.

Examples

- To chart data over a date range: use the filter on the date & time column to restrict the viewed data to the appropriate range. Pressing 'Chart Data' will then automatically chart the displayed data.
- To chart data over two worksheets: Copy the required data to a new worksheet. Copy the 'Date & Time' column into two columns. Reformat column 1 as date, and column 2 as time. Select the data to graph and press the 'Chart Wizard' button to graph the data.

Note: *The charting process is complex and may require some time to complete on slower machines, or if large amounts of data is being charted. Also, Excel has a built-in charting limit of 32,000 data points. To obtain larger graphs, a database system such as Microsoft Access is required.*

Printing: Printing the data

The workbook settings are pre-formatted to allow for easy printing. Column headings and comments appear on each printed sheet.

Users may, of course, customize the printout to their individual requirements by using Excel's built-in printing features. Refer to the Excel help files for more information.

Security: Locking or protecting the data

Excel incorporates security features that allow spreadsheet data to be locked against accidental or deliberate alteration, from entire worksheets to individual cells. For more details, refer to the Excel help files.

Customization: Calculating long-term average exposures

Because of the large variety of different long-term calculations used in the safety workplace, the EDM workbook does not support automatic long-term calculations.

However, long-term average exposures of any type may be calculated using Excel's built-in mathematical functions. Refer to the Excel help file or user's manuals for more information on how to construct the desired formulae.

Direct Import to Compatible Programs

Information from this point on applies only to users who are not using the E.D.M. plug-in. The following information applies to direct data import into Excel and other compatible programs. To use the datalogger data, insert the data card into a computer adapter and open the data file LOGFILE0.CSV using spreadsheet or database software. Word processors and text editors may also be used, but performance may be poor, since the datalogger file is at least 16 megabytes in size.

Data for user-accessible models is comma-separated-values (CSV) format. The data order is:

- Date, day, time
- H₂S, CO, Combustibles, O₂
- H₂S TWA, CO TWA
- Status codes, serial number

Recorded data includes eight single-character unit status codes. The eight characters represent codes for the H₂S, CO, combustibles, and O₂ sensors, datalogger, unit battery status, and unit alarm status. A summary of most of the available codes can be seen in table A.

Importing the Data File Into Compatible Desktop Applications

Information from this point forward only applies to users who are not using the Excel Datalog Manager (E.D.M.) plug-in.

The recorded data can be loaded into most spreadsheet, database, word processor, or text editor applications, some examples are:

- Microsoft® Excel 95, 98 and 2000;
- Quattro Pro;
- Lotus 1-2-3;
- Microsoft® Access; and
- Microsoft® Word

Determining Application Compatibility

To determine if the application selected is compatible:

- Insert MMC card in to the Card Reader; then

- Open desired application.
- Use the applications “**File/Open** “ menu options to locate and open the data file.

If the recorded data file is compatible with the application, it will open. If not the application will report an error in opening the file.

Important

Some applications have an internal file size limits, and may not load the entire file. Check the application’s specifications prior to use.

Table A: Datalogger Status Codes

Codes	Explanation
<i>General Codes</i>	
—	Normal operation
G	Backlight is on
<i>Sensor Codes</i>	
L	Low Alarm
H	High Alarm
T	TWA Alarm
U	Dual alarm (Low and TWA alarms)
V	Dual alarm (High and TWA alarms)

s	STEL alarm
u	Dual alarm (Low and STEL alarms)
v	Dual alarm (High and STEL alarms)
w	Dual alarm (TWA and STEL alarms)
x	Triple alarm (TWA, STEL and Low)
y	Triple alarm (TWA, STEL and High)
O	Sensor is over-ranged
C	Calibrating
F	Sensor Failure
1	Alarm setpoint 1 (Low alarm)
2	Alarm setpoint 2 (High alarm)
3	Alarm setpoint 3 (TWA alarm)
4	Alarm setpoint 4 (STEL alarm)
D	Calibration due date (in days)
E	Last calibration (in days)
Z	Auto-zeroing
<i>Battery Status Codes</i>	
—	Batteries OK
B	Low battery alarm
K	Confidence beep is active

<i>Alarm Status Codes</i>	
L	Low Alarm
H	High Alarm
T	TWA Alarm
M	Multi-gas Alarm
C	Calibration
Q	Manual Shutdown
S	Automatic Shutdown
F	Self-test Fail
R	Real-time Clock Failure

Note: TWA readings greater than 99 are recorded as OL.

When datalogger information is imported into most spreadsheet software, it will appear similar to the example below; line numbers are included here for clarity.

Note: Some compatible software packages have an internal file size limit of and may not load the entire file. Check your software limit.

Line	Date (dd-mm-yy)	Day (Mon=1)	Time (hh:mm:ss)	H ₂ S (ppm)	CO (ppm)	LEL (%LEL)	O ₂ (%)	H ₂ S TWA (ppm)	CO TWA (ppm)	Unit Status	Serial Number
1	17-07-02	#3	9:54:25	10	35	--	--	--	--	33-----	S102-002350
2	17-07-02	#3	9:54:30	15	50	--	--	--	--	44-----	S102-002350
3	17-07-02	#3	9:54:35	10	35	10	19.5	--	--	1111----	S102-002350
4	17-07-02	#3	9:54:40	15	200	20	23.5	--	--	2222----	S102-002350
5	17-07-02	#3	9:54:45	--	175	--	5	--	--	-D-E---D	S102-002350
6	17-07-02	#3	9:54:50	0	0	0	20.9	0	0	-----	S102-002350
7	17-07-02	#3	9:54:55	2	7	14	20.2	0	0	--L---L	S102-002350
8	17-07-02	#3	9:55:00	11	37	34	20.2	0	0	LLH---M	S102-002350
9	17-07-02	#3	9:55:05	13	47	35	20.3	0	0	LLH---M	S102-002350
10	17-07-02	#3	9:55:10	13	59	13	20.3	0	0	LLL---M	S102-002350
11	17-07-02	#3	9:55:15	8	39	0	20.3	0	0	-L-----L	S102-002350
12	17-07-02	#3	9:55:20	2	7	0	20.3	0	0	-----	S102-002350
13	17-07-02	#3	9:55:25	0	0	0	20.9	0	0	-----B-	S102-002350
14	17-07-02	#3	9:55:30	0	0	0	20.9	0	0	-----B-	S101-002350

In this example:

Line 1 shows the TWA alarm setpoints (code '3') for H₂S and CO.

Line 2 shows the STEL alarm setpoints (code '4') for H₂S and CO.

Line 3 shows the low alarm setpoints (code '1') for all sensors.

Line 4 shows the high alarm setpoints (code '2') for all sensors. Alarm points are only recorded when the unit is turned on, indicating the unit has just been activated.

Line 5 shows the number of days remaining before calibration is due and the days since the last calibration.

Line 6 shows normal operation. There are no gas alarms.

Line 7 shows a combustible gas alarm. H₂S and CO gases are present below alarm levels. Oxygen is less than 20.9% but within acceptable range. The unit is in low alarm.

Lines 8 and 9 show H₂S and CO in low alarm, and combustibles (0-100% LEL) in high alarm. Oxygen is less than 20.9% but within acceptable range. The unit is in multi-gas alarm.

Line 10 shows H₂S, CO and combustibles (0-100% LEL) in low alarm. Oxygen is less than 20.9% but within acceptable range. The unit is in multi-gas alarm.

Line 11 shows CO in low alarm. Oxygen is less than 20.9% but within acceptable range. H₂S is present below alarm levels. The unit is in low alarm.

Line 12 shows H₂S and CO present below alarm levels. Oxygen is less than 20.9% but within acceptable range. There are no gas alarms.

Lines 13 and 14 show the unit emitting a low battery alarm. There are no gas alarms.

MultiMediaCard Compatibility

A standard 32MB MMC Flash Memory card is supplied with the detector. When purchasing additional MultiMediaCards, BW Technologies recommends MMC Flash Memory cards that contain between 32 MB and 128 MB storage capacity.

MultiMediaCard(s) compatible with the “MMC” specification will always have the exact word “MultiMediaCard” or “MMC” written on the disk or package. Cards that do not contain these exact words are not a MultiMediaCard.

The “MMC” is **not** the same as the following:

- MultiMedia card;
- Multi media card;
- SmartMedia
- CompactFlash
- Memory Stick

MMC cards are available through retailers throughout the world. They are also available through mail order and Internet vendors.

MultiMediaCard Troubleshooting

A warning message will display if the card is absent. **note:** **no data card installed.** The card is not required for operation of the User Downloadable Datalogger models.

A new MMC Card is automatically formatted when it is installed in the detector. When installing any new or blank MMC card into the detector the LCD will display **card IS blank**, then the detector will proceed to auto-format the MMC card.

Recovering Data Files

If the MMC card is reformatted or erased accidentally by your computer application, the recorded data file can be recovered.

FIRST: First ensure the card is installed properly in the card reader. If the recorded data file is not visible ensure that:

The card reader is visible in the **My Computer** window.

- If not, verify that the card reader is installed correctly and that the connections are secure.
- In the “Removable Disk” drive window, ensure All Files are selected in the File Types field.
- “Reformat and Recover Deleted Files”

Place the MMC card back into the detector. The detector will reformat. The file should now be available.

If the Recorded Data File (Logfile.csv), is still not visible:

- Format the MMC card in Windows.
- Remove the MMC card from the card reader.

- Insert the MMC card back into the detector.
- Allow the detector to reformat the MMC card.
- Remove the MMC card from detector.
- Insert the MMC card back into card reader.
- Select the My Computer icon.
- Select the drive that corresponds to the card reader.
- The Recorded Data File (Logfile.csv), will now be visible.

If the Recorded Data File is still not visible, insert the MMC into the detector and turn it on. The LCD will advise: **Error. DATA FILE HAS BEEN DELETED**. You will then be given the choice of erasing or restoring the data. Use **▲** or **▼** to scroll through the options. Press **○** to confirm your choice.



To restore the data, select **rESTore**. The detector will then restore the data to the MMC, and will resume the start-up procedure.

To permanently erase the data on the MMC, select **ErASE**. The display will then read, **Are You Sure?**

Note: *once data is erased using this process, it cannot be retrieved.*

Press **○** to confirm your choice or **Ⓢ** to abort. If you choose to abort the erasing procedure, the display will read, **ErASE AbortEd**.

The display will then read **note: cArD cAnnot bE USEd PULL oUt cArD to cont InUE**. Insert a new card or erase the data. Once you confirm your decision to erase the data on the MMC or there is a new card inserted the detector will resume normal operation.



D2067/3 English

iERP: 115021

© 2002 BW Technologies. All rights reserved. Printed in Canada.

All product names are trademarks of their respective companies.

