

NEO BENZ

Benzene/Butadiene - Selective Photo-ionization Detector MP186

User's Guide



mPower Electronics
Making Powerful Senses

Version 1.03

May 2021

Contents

Read Before Operating	3
General Information	4
User Interface	5
Display	6
Charging a Lithium-Ion Battery	7
Low Voltage Warning.....	7
Clock Battery	7
Data Protection While Power Is Off	7
Instrument Basic Functions	8
Turning The Instrument On	8
Turning the Instrument Off.....	8
Integrated Sampling Pump.....	8
Pump Status	9
External Water-trap Filter.....	9
Alarm Signals	9
Alarm Signal Summary.....	9
Preset Alarm Limits & Calibration	10
Testing The Alarms.....	10
Backlight.....	10
Datalogging	10
Man Down	10
Wireless	10
Operating Mode Overview	11
VOC Mode Main Menu	11
Benzene Tube Mode Main Menu	12
Benzene Tube Measurements	12
STEL Measurement	14
Benzene Tube Replacement.....	14
Configuration Mode	16
Navigating Config Mode	16
Selection From a List.....	16
Entering Numerical Values.....	16
Entering and Exiting Config Mode.....	16
Config Mode Menus	17
Calibration	19
Measurement.....	21
Alarm Settings	22
Datalog.....	23
Monitor (Mnt) Setup.....	24
Wireless	27
Computer Interface Using mPower Suite	28
Connecting and Configuring.....	28
Custom Gas (User Gas) in VOC Mode.....	30
Datalog Retrieval.....	31
Real-time Data.....	32
Maintenance	33
Cleaning or Changing PID Sensor/Lamp	33
Lamp Cleaning and Changing.....	33
Sensor Cleaning	34
Sampling Pump.....	34
Troubleshooting.....	35
Contact Information.....	36

Read Before Operating

This manual must be carefully read by all individuals who have or will have the responsibility of using, maintaining, or servicing this product. The product will perform as designed only if it is used, maintained, and serviced in accordance with the manufacturer's instructions. The user should understand how to set the correct parameters and interpret the obtained results.

CAUTION!

To reduce the risk of electric shock, turn the power off before removing the instrument cover. Disconnect the battery before removing sensor module for service. Never operate the instrument when the cover is removed. Remove instrument cover and sensor module only in an area known to be non-hazardous.

Special Notes



When the instrument is taken out of the transport case and turned on for the first time, there may be some residual organic or inorganic vapor trapped inside the detector chamber. The initial PID sensor reading may indicate a few ppm. Enter an area known to be free of any organic vapor and turn on the instrument. After running for several minutes, the residual vapor in the detector chamber will be cleared and the reading should return to zero.



The battery of the instrument discharges slowly even if it is turned off. If the instrument has not been charged for one week, the battery voltage may be low. Therefore, it is a good practice to always charge the instrument before using it. It is also recommended to fully charge the instrument for at least 10 hours before the first use. Refer to this User Guide's section on battery charging for more information on battery charging and replacement.



Do not remove the filter when the instrument is on, otherwise, dust entry will reduce the accuracy of measurement, shorten the life of the sensor, and possibly damage the sensor.



Benzene filtering tubes can form chromic acid when humid air is drawn through them for extended periods. Tubes should be used for no more than a 15-minute STEL measurement because the acid formed can severely damage the instrument if drawn into it by the sampling pump. The quantities in each box of tubes are under the *de minimus* amounts for shipment of hazardous materials; however spent tubes should be disposed of according to local regulations. Butadiene tubes contain no hazardous materials.

WARNINGS

STATIC HAZARD: Clean only with a damp cloth.

For safety reasons, this equipment must be operated and serviced by qualified personnel only. Read and understand the instruction manual completely before operating or servicing.

- Use only mPower battery pack M011-3002-000. Substitution of components may impair intrinsic safety. Recharge batteries only in non-hazardous locations.
- Do not mix old and new batteries or batteries from different manufacturers.
- For maximum safety, the accuracy of the instrument should be checked by exposing it to a known concentration calibration gas before each day's use.
- Do not use USB/PC communication in a hazardous locations.

NOTE on FCC RULES

- This equipment has been tested and found to comply with the limits for a Class B digital device, pursuant to part 15 of the FCC Rules. These limits are designed to provide reasonable protection against harmful interference in a residential installation. This equipment generates, uses and can radiate radio frequency energy and, if not installed and used in accordance with the instructions, may cause harmful interference to radio communications. However, there is no guarantee that interference will not occur in a particular installation. If this equipment does cause harmful interference to radio or television reception, which can be determined by turning the equipment off and on, the user is encouraged to try to correct the interference by one or more of the following measures:
 - Reorient or relocate the receiving antenna.
 - Increase the separation between the equipment and receiver.
 - Connect the equipment into an outlet on a circuit different from that to which the receiver is connected.
 - Consult the dealer or an experienced radio/TV technician for help.
- To satisfy FCC/IC RF exposure requirements, a separation distance of 20 cm or more should be maintained between the antenna of this device and persons during device operation. To ensure compliance, operations at closer than this distance is not recommended.

General Information

The NEO BENZ uses a combination of a selective 9.8 eV lamp and benzene filtering tubes to measure benzene selectively in mixtures of hydrocarbons as may be present in fuels or hazardous waste sites. It has two main detection modes: A continuous mode for VOCs (Volatile Organic Compounds) with a range from about 5 ppb up to 10,000 ppm, and a single-sample mode using filtering tubes for benzene- or butadiene-selective measurements in the range 0.05 to 200 ppm. The continuous mode can be used to screen for benzene or butadiene without a filtering tube, and if a response over the alarm limit is detected, a tube can be inserted to measure what fraction of the alarm response was actually due to benzene or butadiene. The 45-second benzene-specific measurement time is the fastest on the market.

Note on Butadiene: Although this manual is written mainly for benzene measurements, all procedures and diagrams relating to benzene are meant to apply to butadiene as well, unless noted.





The NEO Series is one of the most advanced handheld VOC monitors available for ppb- and ppm-level detection. Novel designs of the photo-ionization detector (PID) and ultraviolet (UV) lamp provide outstanding sensitivity, stability and reproducibility.

Key Features

- Size: 13.7 x 2.9 x 2.2 in (350 x 74 x 55 mm) with boot and tube holder
- Weight: 28 oz (788 g)
- 50 ppb to 200 range for benzene or butadiene and 5 ppb to 10000 ppm for VOC
- Fast 45-second benzene-specific response (at room temperature)
- 3-second response time for 90% change (using isobutylene in VOC mode)
- Integrated correction factors list of several hundred compounds
- Built-in pump for up to 30 meters sampling distance
- Easy service and maintenance
- Micro-USB charge port

User Interface

The instrument's user interface consists of the LCD display, Alarm LEDs, an alarm transducer, and four keys. The keys are:

- Left Key: 
- Right Key: 
- Up Key: 
- Down/Mode Key: 

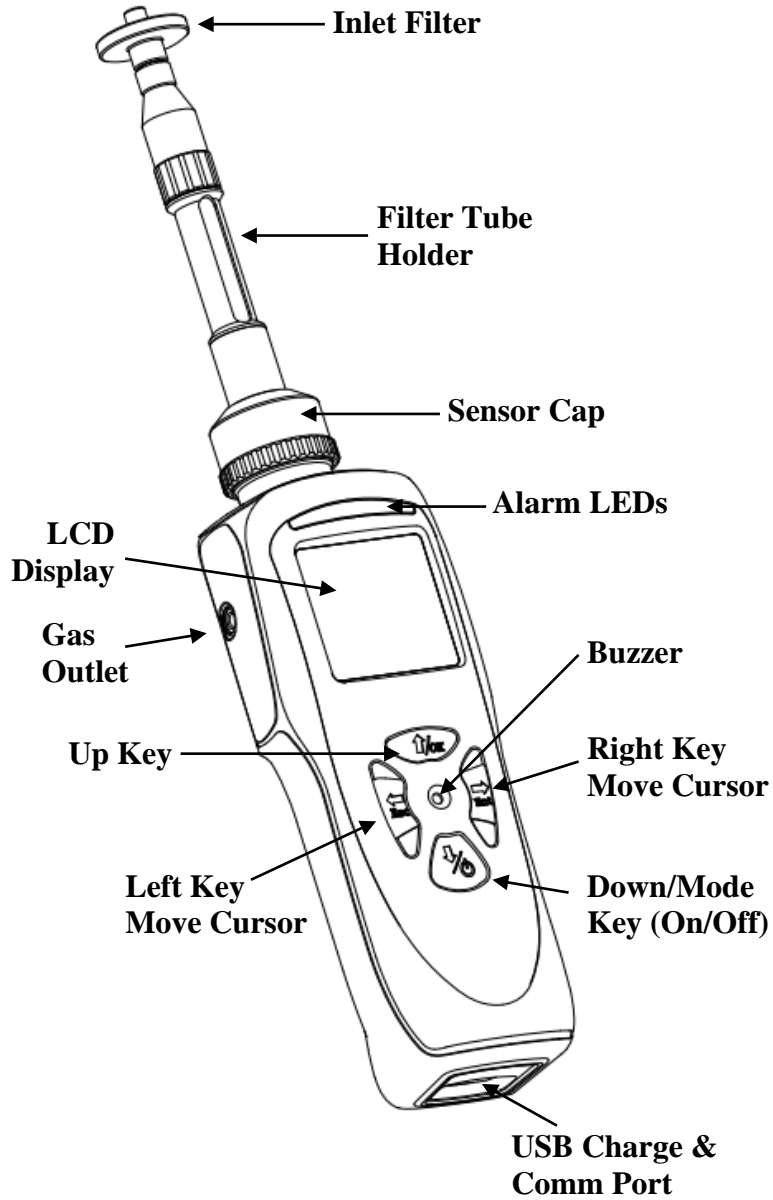

NEO BENZ user interface

Display

The LCD display provides visual feedback that includes the reading, tube mode indicator, pump status, Man-Down, time, battery condition, and other parameters.

The display shows the following information:

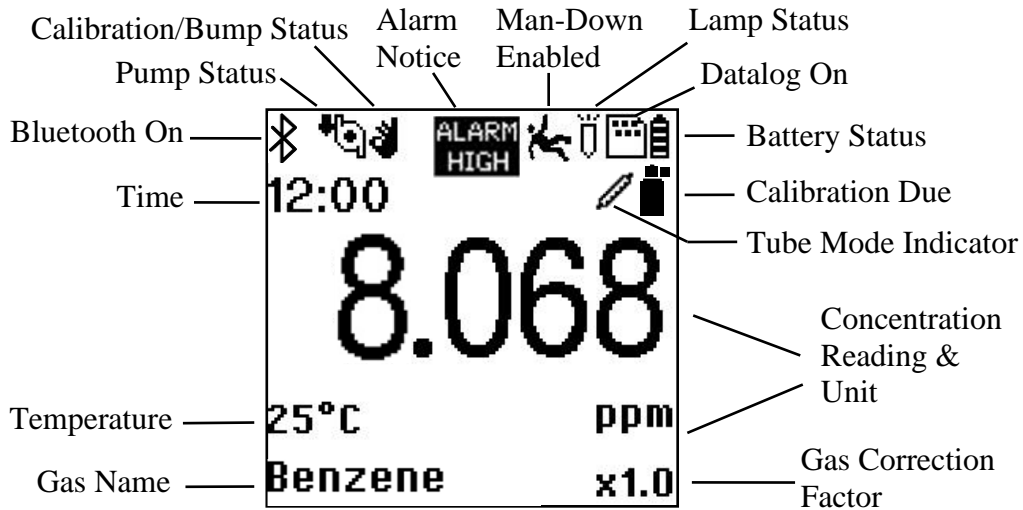

LCD display

Item	Description
Gas Name and CF	Shows the measurement gas and its correction factor
Reading	Concentration of gas measured by the instrument
Tube Mode	Indicates unit is in tube sampling mode
Calibration Due	Cylinder icon appears when calibration is due
Pump Status	Indicates whether the pump is working or blocked
Man-Down Status	Icon appears when Man-Down alarm is enabled
Lamp Status	Lamp icon is shining when on and crossed out when off
Bluetooth Enabled	Local Wireless Communication is enabled
Datalog On	Verifies that datalogging is on
Battery Status	Indicates battery capacity in 3 bars
Time	Indicates current time or STEL sampling time remaining
Temperature	Indicates current temperature inside the instrument

Charging a Lithium-Ion Battery

Always fully charge the battery before using the instrument. The screen will display a battery icon from empty (no bars) to fully charged (3 bars).

Follow this procedure to charge the instrument:

1. Plug the Micro-USB into the charging port at the bottom of the instrument.
2. Plug the USB connector* into either a) a personal computer, or b) into the AC/DC adapter and plug the AC/DC adapter into the wall outlet.

The instrument begins charging automatically. The charging LED turns red to indicate charging. During charging, the 3 bars in the battery icon on the instrument's display are animated. When the battery is fully charged, the LED turns green, the icon is no longer animated and shows a full battery, and the message 'Fully Charged' is displayed.



***NOTE:** Any locally-obtained USB A to Micro B USB cable will work for charging, but will not work for communication with mPower Suite configuration and data transfer software. The mPower USB cable P/N M-011-3003-000 is required for a PC to recognize the instrument and communicate with mPower Suite.

WARNING!

To reduce the risk of ignition of hazardous atmospheres, recharge and replace batteries only in areas known to be non-hazardous. Use only mPower's rechargeable lithium battery part number: M011-3002-000.

Low Voltage Warning

When the battery's charge falls below a preset voltage, the instrument warns you by beeping once and flashing once every minute, and the "empty battery" icon blinks on and off once per second. Turn off the instrument within 10 minutes and either recharge the battery, or replace the battery with a fully charged one.



Clock Battery

An internal clock battery is mounted on one of the instrument's printed circuit boards. This long-life battery keeps settings in memory from being lost whenever the Li-ion battery or alkaline batteries are removed. This backup battery should last approximately five years, and must be replaced by an authorized mPower service technician. It is not user-replaceable.

Data Protection While Power Is Off

When the instrument is turned off, all the current real-time data including last measured values are erased. However, the logged data are preserved in non-volatile memory, so that even if the battery is disconnected, the logged data will not be lost.

Instrument Basic Functions

The NEO gives real-time measurements or single-point benzene measurements and activates alarm signals whenever the reading exceeds preset limits. Prior to factory shipment, the instrument is preset with default alarm limits and the sensor is pre-calibrated with standard calibration gas. However, the instrument should be tested and the calibration verified before the first use. After the instrument is fully charged and calibrated, it is ready for immediate operation.

Turning The Instrument On

Press and hold the Mode (Down) key  until the display, beep buzzer & LEDs turn on.

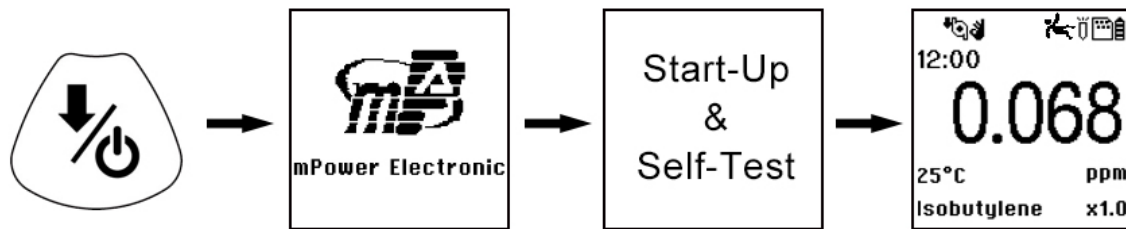

If the mPower logo does not appear first, there is likely a problem and a distributor or mPower Technical Support should be contacted. The instrument then performs self-tests after the screen displays the firmware version and serial number.

Self-tests include:

Self Test	
Pump.....	OK
Clock.....	OK
Datalog.....	OK
Motion.....	OK
PID.....	OK
Wireless.....	OK

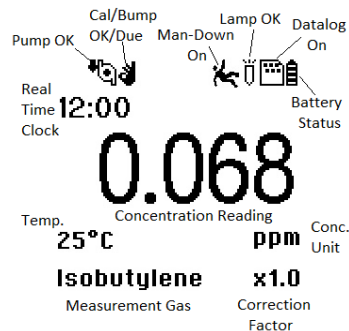

After self-tests, the instrument will show sensor information and instrument configuration information in sequence. Once the startup procedure is complete, and a numerical reading screen with icons is displayed, the instrument is fully functional and ready for use.

Turning the Instrument Off

Press and hold the Down key  for 3 seconds, and continue to hold for a 5-second countdown until “Unit off...” is displayed.

Integrated Sampling Pump

The instrument includes an integrated, diaphragm-type sampling pump that can operate at low or high speed, ranging from about 300 to 430 cc/min, respectively, with no filters, 260 to 390 cc/min with a standard 0.45 µm filter in place, and about 240 to 350 cc/min with both a benzene tube and 0.45 µm filter. Flow will decrease if the 0.45 µm filter accumulates particulate matter, or if a filter is not used and particles get caught in the pump diaphragm. Connecting Teflon tubing with 1/8" inside diameter to the gas inlet port, this pump can pull air samples from 200' (61 m) away horizontally, or

90' (27.5 m) vertically, at about 3' (0.9 m) per second flow rate. Note that at 200' the PID response will be delayed by about 1 minute, the time required for the gas sample to reach the instrument.

IMPORTANT!

During operation, make sure the probe inlet and the gas outlet are free of obstructions. Obstructions can cause premature wear on the pump, false readings, or pump stalling.

Pump Status

During normal operation, the pump icon alternately shows inflow and outflow. If there is a pump failure or obstruction, the alarm sounds and the pump stall icon blinks on and off. If this occurs, clear the obstruction and press the Right key to restart the pump.

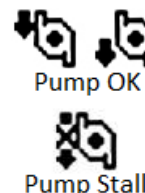

External Water-trap Filter

The external filter is made of a PTFE (Teflon®) or PVDF membrane with 0.45 micron pore size to prevent dust or other particles from being sucked into the sensor manifold, which could damage the instrument. It prolongs the operating life of the sensor and pump. To install the external filter, simply screw it in to the instrument's inlet probe using the Luer connection.

Alarm Signals

During each measurement period, the gas concentration is compared with the programmed alarm limits (gas concentration alarm limit settings). If the concentration exceeds any of the preset limits, the loud buzzer and red flashing LED are activated immediately to warn of the alarm condition.

In addition, the instrument alarms if one of the following conditions occurs: battery voltage falls below a preset voltage level, failure of the UV lamp, or pump stall.

Alarm Signal Summary

Message	Condition	Alarm Signal
HIGH	Gas exceeds 'High Alarm' limit	3 beeps/flashes per second
OVR	Gas exceeds measurement range	3 beeps/flashes per second
MAX	Gas exceeds electronics' max range	3 beeps/flashes per second
LOW	Gas exceeds 'Low Alarm' limit	2 beeps/flashes per second
TWA	Gas exceeds 'TWA Alarm' limit	1 Beep/flash per second
STEL	Gas exceeds 'STEL Alarm' limit	1 Beep/flash per second
Remove Tube	STEL measurement completed	1 Beep/flash per second
Pump icon flashes	Pump failure	3 beeps/flashes per second
Lamp	PID lamp failure	3 beeps/flashes per second plus 'Lamp' message
Battery icon flashes	Low battery	1 flash, 1 beep per minute plus battery icon flashes
CAL	Calibration failed, or is overdue	1 beep/flash per second
NEG	Gas reading measures less than number stored in calibration	1 beep/flash per second

Preset Alarm Limits & Calibration

The instrument is factory calibrated with standard calibration gas, and is programmed with the following default alarm limits:

Cal Gas	Cal Span	unit	Low	High	TWA	STEL
Benzene	5	ppm	0.5	2.5	0.5	2.5
Isobutylene	10	ppm	50	100	10	25

Alarm limits and calibration parameters can be adjusted in Configuration Mode as desired for particular testing purposes and applications.

Testing The Alarms

The alarm can be tested whenever the main (Reading) display is shown. Press the Right key, and the audible and visible alarms are tested.

Backlight

The LCD display is equipped with an LED backlight to assist in reading the display under poor lighting conditions. Background lights can be turned on automatically under poor light condition and be set in a variety of ways. We can choose from the settings menu under Config Mode or through mPower Suite.

Datalogging

Datalogging is always on, and the disk icon displayed indicates that it is functioning properly. The default logging interval is 60 seconds, which allows up to one year of data storage. When storage is full, the oldest data are overwritten.

The instrument stores the measured gas concentration at the end of every sample interval (when datalogging is enabled). In addition, the following information is stored: user ID, site ID, serial number, last calibration date, and alarm limits. All data are retained (even after the unit is turned off) in non-volatile memory so that it can be down-loaded at a later time to a PC. Stored data are organized into 'events', with a new event created each time the instrument is turned on, or a configuration parameter is changed, or datalogging is interrupted.

After an event is recorded, the unit records a shorter form of the data. When transferred to a PC running mPower Suite, these data are arranged with a sample number, time, date, gas concentration.

Man Down

Settings are available for On/Off depending on the user's requirement.

The Man Down Alarm is a critical and potentially lifesaving safety feature of the NEO. Its function is based on the premise that if the instrument is motionless when it is not supposed to be, its user may be in distress. If that is the case, the NEO not only goes into alarm locally on the instrument, but also remotely, over a wireless network, to notify people in the vicinity, as well as remote safety officers at a command center, that a person is down, so that help can be dispatched quickly.

Note: Remote notification requires wireless connection to a network.

Wireless

When NEO is equipped with wireless capability, it is set up through the wireless sub-menu.

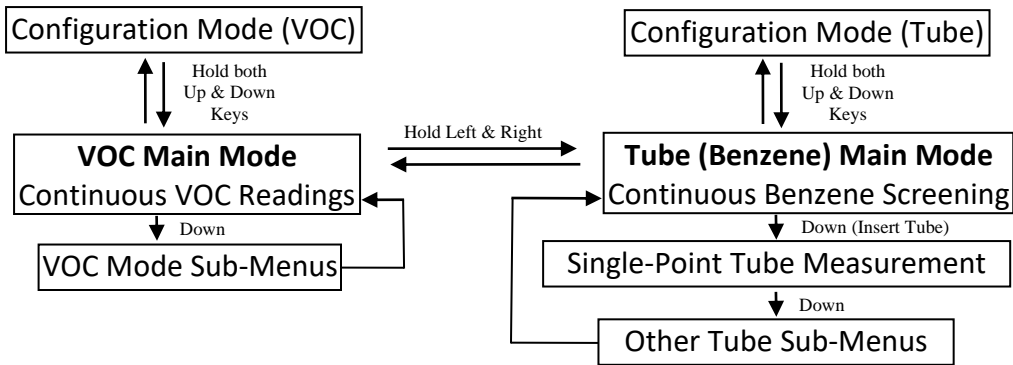

Operating Mode Overview

The instrument works in either **VOC Mode** for continuous VOC readings or **Tube Mode** for single-point benzene-specific measurements. The VOC Mode can be configured to read any desired gas using any correction factor (CF) or lamp, whereas the Tube Mode can only be used for benzene (or butadiene) measurements with a 9.8 eV lamp. When the unit is turned on, it enters **VOC Main Mode**. To switch between **VOC Mode** and **Tube Mode**, press and hold the Left and Right keys simultaneously for a few seconds. In each of these main modes, basic users can only see and use a limited set of functions. Advanced users can access the **Configuration Mode**, which is password protected, to adjust various parameters. The Configuration Modes are slightly different depending



on whether one is entering from VOC Mode or Tube Mode. Switching between **Benzene Tube Mode** and **Butadiene Tube Mode** is done in the Monitor Set-Up. Some parameters are not accessible on the instrument display and the mPower Suite software must be used to change the settings.

VOC Mode Main Menu

The VOC Main Mode screen shows real-time readings and auxiliary information. Press the Up key  or Down key  to cycle through the sub-menu screens.

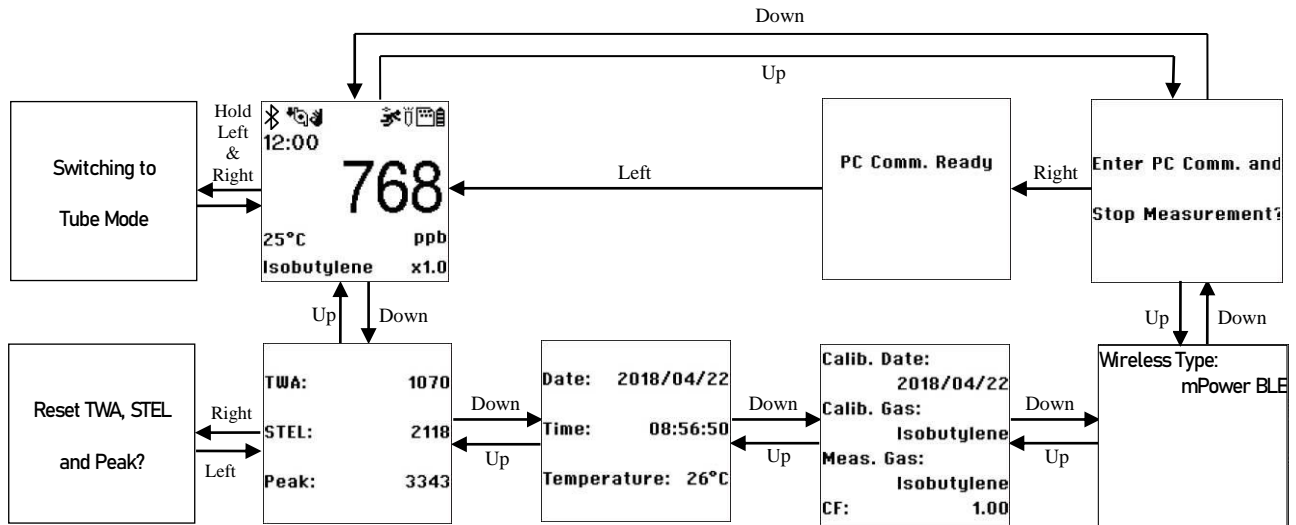

Flow chart for VOC Main Mode

Benzene Tube Mode Main Menu

The Benzene Mode main screen shows real-time readings and auxiliary information. Press the Up or Down key to cycle through the sub-menu screens.

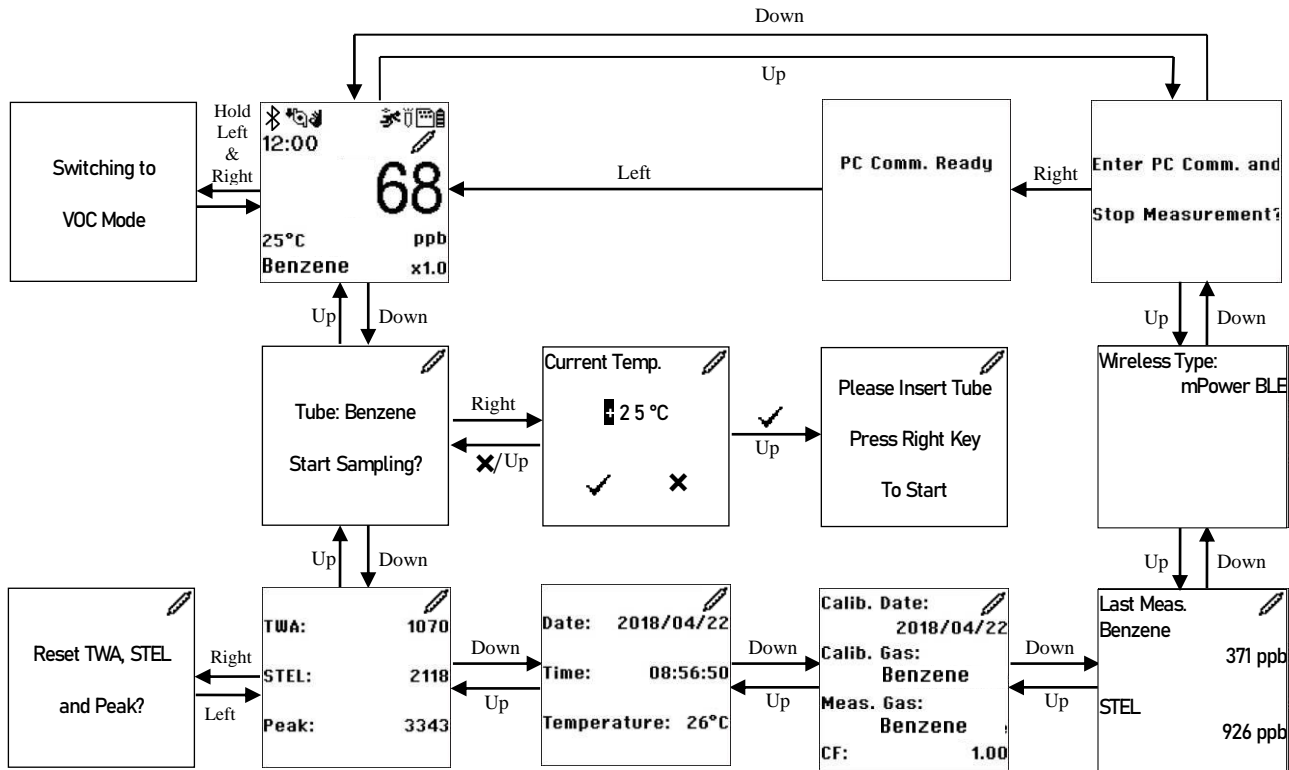

Flow chart for Tube (Benzene) Main Mode

Benzene Tube Measurements

1. Ensure that the monitor is zeroed and calibrated a) in Benzene Mode, b) with 5 ppm benzene, c) using a benzene tube AND preferably at the temperature of intended measurements
2. Use Continuous Benzene Screening Mode (Tube Main Mode) to continuously monitor for benzene without a filtering tube.
3. If a reading above the alarm limit is found, take a single-point benzene measurement using a tube, as follows:

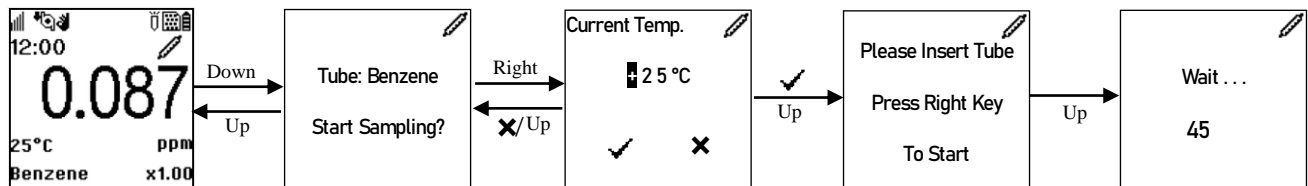

- a. From Benzene Screening Mode (Tube Main Mode), press Down.
- b. When asked to start sampling, press the Right key.
- c. Enter the temperature using the Up & Down keys to increase or decrease and the Right & Left keys to move the cursor. Move to ✓ and press Up. The temperature entered is that of the air to be sampled, not the internal instrument temperature. If the tube is warmed to shorten sampling time, enter the average of the air and tube temperatures.

- d. When prompted to insert a tube, open both ends of a benzene filtering tube using the tube tip breaker, taking caution to protect eyes and hands from sharp glass pieces.

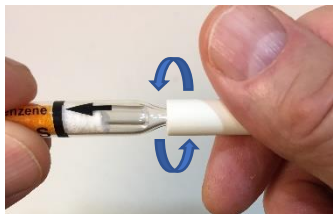
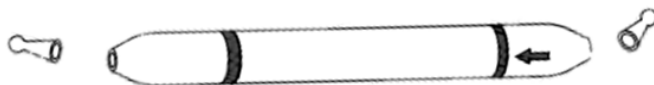

Insert tube fully into ceramic tip breaker and rotate to etch glass

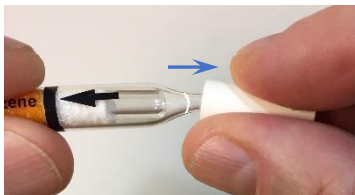

Pull breaker away slightly from etch mark



Grip tube close to end and snap off tip

- e. Unscrew the top section of the tube holder, insert the tube with the arrow pointing towards the instrument, and screw the top section back on.

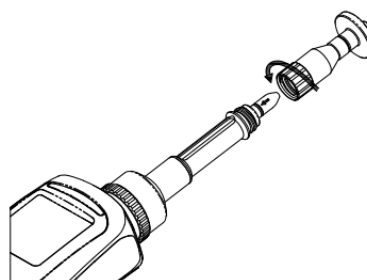
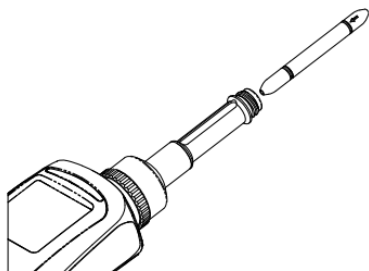
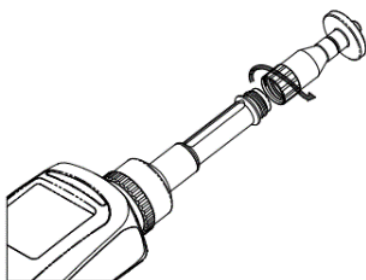

- f. Briefly hold a finger on the probe tip and listen for a strain on the pump, to ensure flow is blocked and thus check for a good seal on the tube.
 g. Direct the probe to the sampling point and press the Up key to start a count-down timer. The sampling time is 45 s at room temperature, but ranges from 30 s to 360 s depending on temp.
 h. Press Left at any time to abort the measurement.

Benzene Tube Measurement Time vs Temperature

Temp. °C	-10 to -6	-5 to -1	0 to +4	+5 to +9	+10 to +19	+20 to +30	+31 to +50
Temp. °F	+14 to 21	+23 to 30	32 to 39	41 to 48	50 to 66	68 to 86	88 to 122
Run Time	360 s	240 s	170 s	110 s	60 s	45 s	30 s

Butadiene Tube Measurement Time vs Temperature

Temp. °C	-10 to -6	-5 to -1	0 to +4	+5 to +9	+10 to +19	+20 to +34	+35 to +50
Temp. °F	+14 to 21	+23 to 30	32 to 39	41 to 48	50 to 66	68 to 93	95 to 122
Run Time	NA	NA	360 s	300 s	240 s	180 s	120 s

- i. Monitor the color of the tube through the holder window during the measurement (butadiene tubes do not change color). If the tube turns brown or greenish-brown for more than 2/3 of its length, the filtering capacity of the tube may be exceeded and false high readings could result.

At the end of the sampling time, the screen shows the concentration of the current benzene test and asks whether to continue on to a STEL measurement (using the same tube).

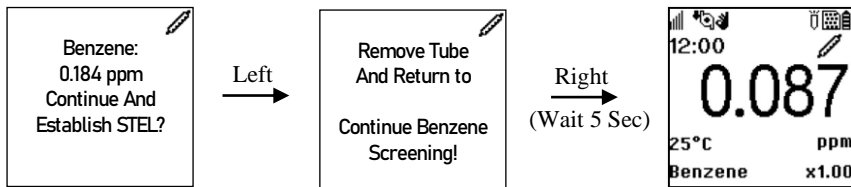

Press Left to omit a STEL measurement. When prompted, remove the tube and press Right and wait 5 seconds to escape back to Continuous Benzene Screening.

STEL Measurement

Press Left to or Right to continue with STEL sampling for a 15-minute countdown, shown in the upper left corner (“STEL” alternating with remaining time). Note that the 15 minutes are shortened by the initial sampling time of 30-360 s. The pump automatically slows down during STEL measurement to maximize the ability of the tube to filter out interfering chemicals.

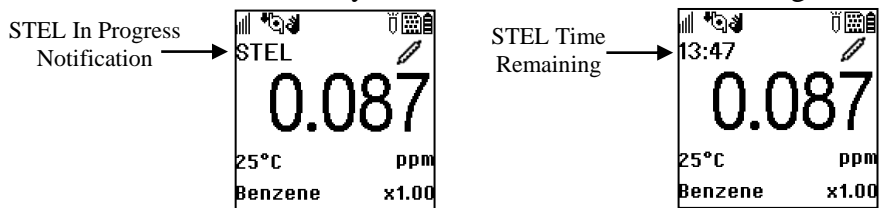

The reading displayed during the STEL measurement is not the instantaneous reading, but rather the accumulated STEL calculation. This is done so that the user can abort work or don protective equipment to avoid further exposure if STEL has been reached before 15 minutes have elapsed.

$$\text{STEL} = \text{Average Concentration} \times \frac{\text{Time Elapsed}}{15 \text{ min.}}$$

However, the unit still alarms if the instantaneous concentration exceeds the programmed Low or High alarm limits. STEL measurement can be aborted by pressing the Right key, and the Right key again when the unit beeps, and the Right Key a third time to return to benzene tube sampling.

CAUTION!

After a STEL measurement, the pump stops to avoid corrosive liquids from the tube being drawn into the monitor. The monitor beeps once per second to notify the user that STEL is complete. Press the Right Key to stop the alarm and a warning appears to remove the tube. Use the Left key to escape back to Continuous Benzene Screening.

Benzene Tube Replacement

In general it is good practice to replace the benzene filtering tube after each measurement. When used in a high VOC background, and especially after a STEL measurement, it is likely that the capacity of the tube to remove interfering chemicals is used up. See TA Note 11 for a list of capacities for various chemicals. If the tube has turned from a bright orange to a pale orange color, or a greenish-brown stain is seen for more than 2/3 of the tube length, the capacity of the tube is exhausted and a new tube should be used for the next measurement. The image below shows examples of new versus used tubes. The green-brown-blue colors are formed by reactions with VOCs while the pale orange color

is caused by absorption of humidity, which in turn reduces the ability of the tube to absorb VOCs. Similarly, do not crack open tubes until immediately before use, because ambient humidity diffusing in will reduce the capacity for VOCs. Finally, if a tube has registered a benzene reading but does not show a discoloration due to other VOCs or humidity, it should still be replaced because residual benzene can carry over to the next reading. An exception to the tube replacement recommendation can be made for calibration, in that the same tube can be used for zeroing and subsequent span calibration, because the initial zeroing does not bring any benzene, other VOCs, or significant amounts of water vapor into the tube.



Butadiene Tubes give no color change and thus no indication of remaining capacity. The tubes can be re-used as long as the readings are below action levels. But if a second measurement shows a high reading, the tube capacity may have been exceeded and a repeat measurement should be made using a new tube. See TA Note 12 for a list of capacities for various chemicals on butadiene tubes.

Configuration Mode

The Config Mode is used to modify the instrument configuration settings.





Navigating Config Mode

There are two types of menus in Config mode: 1) those that ask for selection from a list and 2) those that ask for a numerical value to be entered.

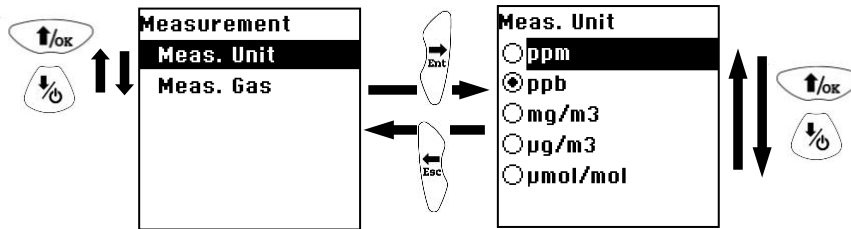
Selection From a List







For example, the Measurement sub-menu contains both a text-format list and a radial-button list.



- Press the Up key  or Mode key  to scroll through the list.
- Press the Right key  to select the menu item.
- Press the Left key  to save and exit.



Entering Numerical Values

For example, to enter a numerical password:

- Increase or decrease the number from 0 through 9 by pressing the Up key  or Mode key .
- Press the Left key  or Right key  to move the cursor.
- After entering the desired numbers, press the Left key  or Right key  to move the cursor to the '✓' mark, and then press the Up key  to accept and move to the next menu.



Entering and Exiting Config Mode

From the main reading display, press and hold the Up key  and Mode key  simultaneously until the Password screen is shown. Input the 4-digit password, move the cursor to '✓', then press the Up key  to enter Configuration Mode.



Note: The default password is 0000. The password can only be changed by connecting the instrument to a PC running mPower Suite software.

Upon successfully entering Config Mode, the screen on the right will be displayed. The Calibration label is shown and its icon is highlighted. Use the





Up key  or Mode key  to scroll through the menu until the desired item is reached, and use the Right key to select it.

To **Exit Config Mode** and return to normal operation, press the Left key repeatedly from any of the Config Menu displays

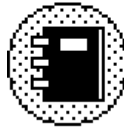

Config Mode Menus

This table summarizes the Config Mode menus and sub-menus. Not all of these menus will be displayed if the option is not set up using mPower Suite software

					
Calibration	Measurement	Alarm Setting	Datalog	Monitor Setup	Wireless
Zero Calib	Meas. Unit	Alarm Limits	Clear Datalog	Data & Time	Radio On/Off
Span Calib	Meas. Gas*	Alarm Mode	Interval	Display	
Set Cal.Gas*		Alarm Settings		Pump Speed	
Set Span Value		Comfort Beep		Set Pump Stall	
Set Span 2 Value [#]		Man-Down Alarm		Rolling Graph	
3-Point Cal.				Real Time Data	
				Language	
				Self-Zeroing	
				Temp. Unit	
				Operating Mode	
				Site ID	
				User ID	
				Tube Type	

* These parameters are not shown in Tube (Benzene) Mode because they are always set to benzene.

[#] Only shown when 3-Point Calibration is selected.

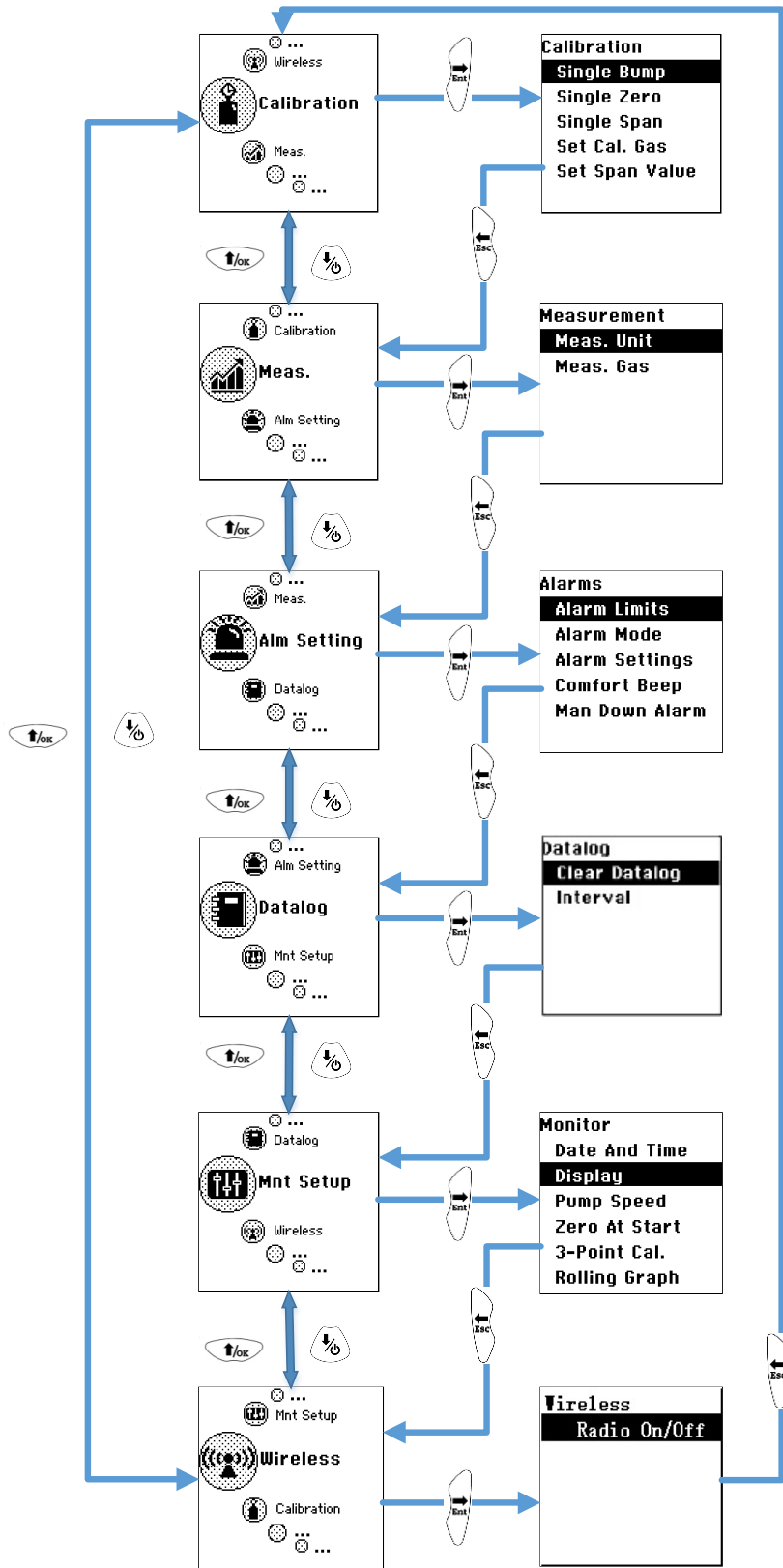

Fig 4: Flow chart for Configuration Mode

Calibration



Calibration Overview

Because the NEO BENZ has two independent operating modes, both VOC and Benzene channels must be zero and span calibrated separately (plus a third calibration for butadiene, if used). Although the instrument will typically hold an approximate calibration for several weeks, when used for worker health and safety it should be calibrated or bump tested before each day's use. The interval between calibrations can be extended based on the user's experience for how long the calibration holds under their operating conditions.

VOC Mode Calibration:

For best accuracy the calibration gas chosen is the same as the gas to be measured. However, if this is inconvenient, isobutylene can be used as a surrogate calibration gas because it has good response and is inexpensive, stable, and non-toxic. A correction factor (CF) can then be applied to make the NEO display in true concentration units of the gas being measured. This CF is selected from the instrument's gas library of several hundred compounds, or entered manually as a user custom gas.

Benzene/Butadiene Mode Calibration:

These modes always uses the gas that matches the tube type, i.e., benzene or butadiene, typically 5 ppm. Because the filtering tubes affect the zero and span readings, both these calibrations must be done using a benzene or butadiene filtering tube in the holder. If zeroing is done first, the same tube can be used for span calibration. **Note on Butadiene:** If butadiene is not available, a second choice is to use isobutylene, with the span value entered equalling 0.74 times the actual concentration. Thus for 5 ppm isobutylene, enter 3.7 ppm for the butadiene span concentration.

Calibration Set-Up

In VOC Mode, span gas from a cylinder is conveniently supplied to the instrument using a regulator with fixed flow rate of about 0.5 L/min (500 cc per min.) to match or slightly exceed the flow rate of the instrument pump. Alternatively, the span gas can first be filled into a gas bag (e.g., Tedlar® bag) or delivered through a demand-flow regulator to match the pump flow precisely. Another alternative is to use a regulator with >500 cc/min flow but allow the excess flow to escape through a T connector or an open tube. **Note on Benzene Tube Mode:** Because flowrate and timing are critical to benzene tube calibrations, use only a flow-matching system such as demand-flow regulator, gas bag, or T connector for benzene calibrations. Do not use a fixed-flow regulator.

Zero Calibration

This procedure determines the zero point of the sensor calibration curve. Connect the instrument to a clean air source free of VOCs such as from a cylinder, gas bag, or ambient air filtered through a charcoal tube (VOC Zeroing Tube). Most outdoor air is sufficiently free of contaminants that it can be used for zero calibration except for measurements in the low ppb range.

Select 'Zero Calib' by pressing the Right key, enter the temperature, insert an opened benzene tube, and press Right again. The message 'Please Apply Zero Gas' is displayed. Press the Up key, and a countdown begins, timed between 30 seconds and 180 seconds, depending on the temperature.

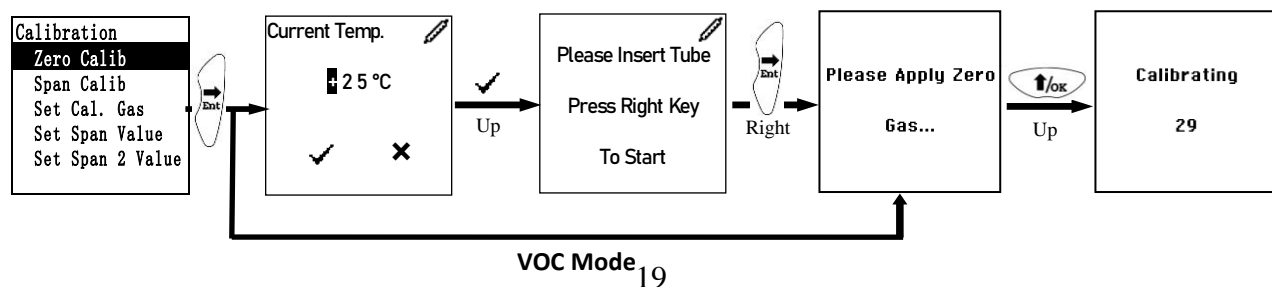

Note: To abort the zeroing and proceed to Span calibration, press the Left key at any time during the process. A confirmation ‘Zero aborted!’ will appear, followed by the Span calibration menu.

When complete, this message “Zero Calibration Done!” is shown, and the display automatically moves to the Span Calibration menu.

Span Calibration

This procedure determines the second (and third, if 3-Point Cal is selected in Monitor Setup) point(s) of the sensor calibration curve. One or two cylinders of standard reference gas (span gas) fitted with a 500 cc/min flow-limiting regulator or a flow-matching regulator is the simplest way to perform this procedure. (A flow-matching regulator, open tube, or gas bag is required for benzene tube calibrations. Do not use a set-up that forces the gas through.) The span gas concentration should be chosen to be near the highest concentration of actual measurements expected. It is also preferred to use the same balance gas (e.g., air or nitrogen) as occurs in the actual measurements because oxygen levels have some effect on the PID response..

To perform a Span calibration, connect the calibration adapter to the inlet port of the instrument, and connect the tubing to the regulator or gas bag. Select ‘Span Calib’ by pressing the Right key to enter the submenu. If in Tube Mode, enter the temperature, insert a tube and press Right. The message ‘Please Apply Gas’ is displayed. Start the gas supply and by press the Up key to begin a 30-second span calibration countdown. The calibration will also start automatically without pressing the Up key if a high enough gas concentration is detected.

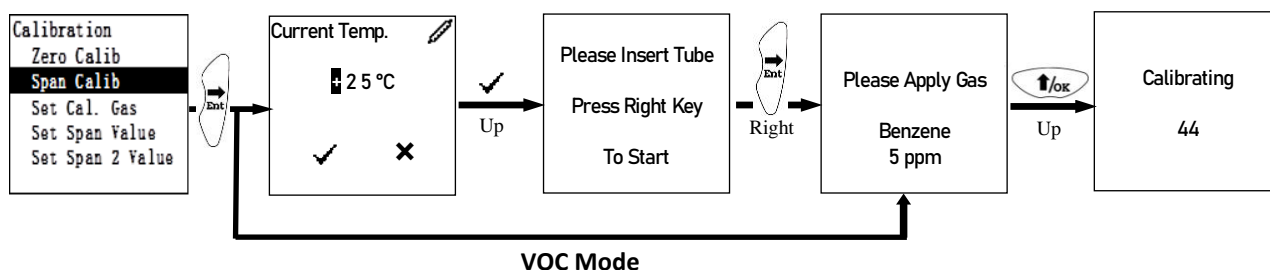

Note: To abort the Span calibration, press the Left key at any time during the process.

When Span 1 calibration is complete, a message similar to this is displayed (the value is an example only):

Span 1 is done!
Reading = 5.00 ppm

3-Point Calibration

If ‘3-Point Cal.’ is enabled (see Monitor Setup), proceed to perform Span 2 in the same manner as for Span 1. 3-Point calibration should be used whenever enhanced accuracy is required. It is especially recommended for measurements above about 500 ppm, where response is not as linear.

Set Calibration Gas

In the Set Cal. Gas menu, select the calibration gas from either the mPower Gas Library or the user’s Custom Gases list. Custom Gas names and parameters can only be set up through the mPower Suite software. This menu is omitted from Benzene Mode because it is always benzene.

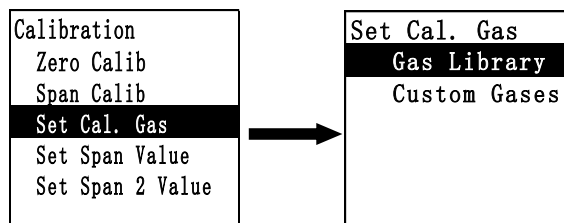

Press the Right key to select Gas Library, or Custom Gases. Press Up or Down to scroll through the gas list until the desired gas name is reached. For high-speed scrolling, press and hold the Up or Down key to skip by alphabetical first letter. Press Right to select the gas and Left to save and exit.

Set Span Value

Span value settings (including Span 2) should match the concentration(s) of standard gas. Check to ensure that the unit of concentration (e.g., ppm or mg/m³) on the gas cylinder agrees with the instrument setting.

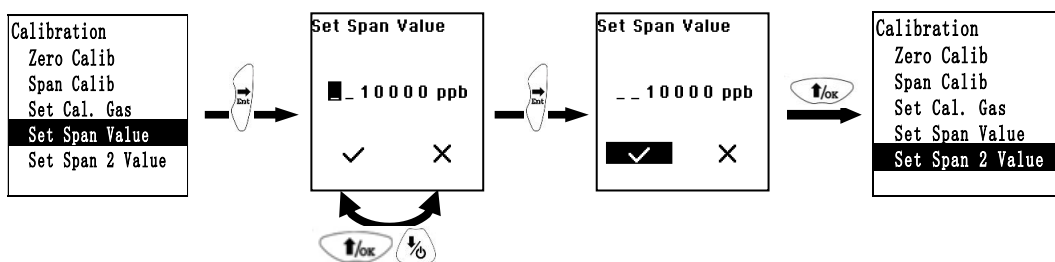

Measurement

The sub-menus for Measurement are Measurement Unit and Measurement Gas (VOC Mode only).

Measurement Unit

Standard available measurement units include:

Unit	Description
ppm	parts per million
ppb	parts per billion
mg/m ³	milligrams per cubic meter
μg/m ³	micrograms per cubic meter
μmol/mol	μmol per mol
10 ⁻⁶	per million

Measurement Gas

Measurement gases are organized in two lists:

- Gas Library is a pre-set list that contains a few hundred chemicals detectable by PID.
- Custom Gases are user-defined, using mPower Suite to set up all gas parameters, including the name, span value(s), correction factor(s), and default alarm limits.

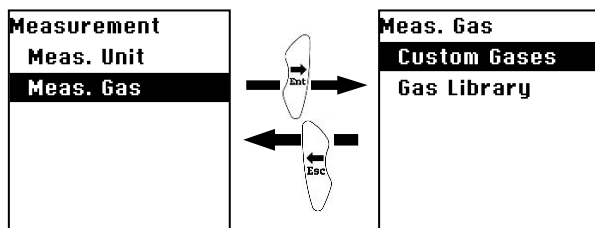
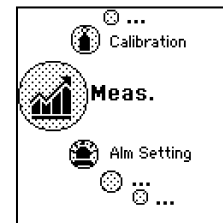

The Measurement Gas menu is not shown in Tube Mode because the gas is always either benzene or butadiene.

Press the Right key to select Gas Library, or Custom Gases. Press the Up key or Mode key to scroll through the gas list. For high-speed scrolling, press and hold the Up key until the desired gas name is reached. Press the Right key to select the gas and the Left key to save and exit.

Alarm Settings

During each measurement period, the gas concentration is compared with the programmed alarm limits (Low, High, TWA and STEL). If the concentration exceeds any of the preset limits, the loud buzzer and red flashing LED are activated immediately to warn of the alarm condition. Press the Right key to enter the Alarm Setting menu.

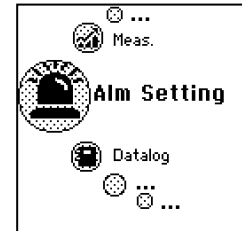

Alarm Limits

In this menu, the High, Low, STEL, and the TWA alarm limits can be changed. Press the Right key to enter the Alarm Limits menu.

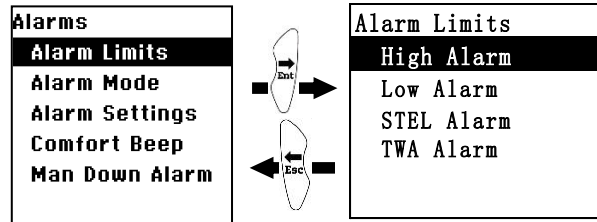

High Alarm

The High Alarm limit is set by the instrument to match the default value for the current measurement gas. To change the High Alarm limit, press the Up or Mode key to increase or decrease each digit's value, and the Right or Left key to move the cursor. Move the cursor to '✓' after the setting is complete, and press Up to save and exit.

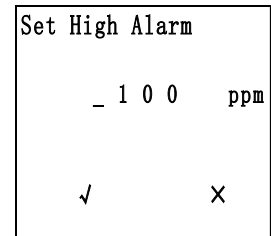

Low, STEL and TWA Alarms

Set the Low, STEL and TWA Alarm limits in the same manner as described above for the High Alarm limit.

Note: All default alarm limits depend on the measurement gas and are expressed in ppm.

Alarm Mode

There are two selectable alarm modes:

Latched

When the alarm is triggered, it stays on even when the concentration falls back below the alarm limit. The alarm must be stopped manually by pressing the Right key. The latched setting only controls High, Low, STEL, and TWA alarms.

Automatic Reset

When the alarm condition is no longer present, the alarm stops automatically.

Press the Up or Mode key to step from one alarm mode to the other. Press Right to select an alarm mode followed by Left to save and exit.

Alarm Settings

The buzzer and light alarms can be programmed to be on or off individually or in combination. The choices are 1) Both on, 2) Light only, 3) Buzzer only or 4)Both off.

Press the Up or Mode key to step from one option to the next. Then press Right to make a selection followed by Left to save and exit.

Comfort Beep

With the Comfort Beep enabled, the buzzer beeps once each minute to indicate that all is OK and the instrument is running normally.

Press the Up or Mode key to step from one option to the next. Then press Right to make a selection followed by Left to save and exit.

Man-Down Alarm

The Man-Down alarm notifies nearby personnel if the instrument remains motionless for about 30 seconds when it should be moving, indicating a possible worker in distress. If the wireless option is enabled, alarm notification is also sent to a remote location. During the Warning Time the alarm beeps 2x per second and asks the user 'Are You OK?'. If so, the user can acknowledge and stop the alarm by pressing the Left Key, or simply tilting the instrument briefly. If the Warning Time expires without acknowledgment, the full Man-Down Alarm of 3x beeps per second begins.

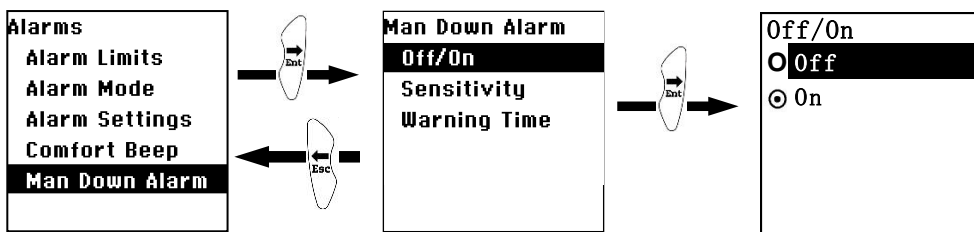

Man-Down Alarm Off/On

Press Right to make a selection followed by Left to save and exit.

Sensitivity

This sensitivity of motion sensor can be set to Low, Medium or High. Low sensitivity means fewer alarms and High sensitivity means easier detection of stopped motion and more chance of an alarm. Use Up or Mode to move up or down the list, Right to select, and Left to save and exit.

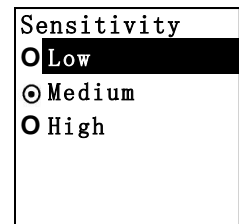

Warning Time

The Warning Time is the amount of time the Man-Down alarm stays on after it is triggered. The default time is 30s.

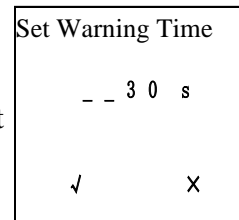

Datalog

The instrument automatically stores the concentration readings at regular time intervals (this function cannot be turned off). In the datalog sub-menu, a user can adjust the interval or clear all data. Press Right to enter the Datalog menu.

Clear Datalog

This erases all the data stored in the datalog.

Caution: Once the data are cleared, they cannot be recovered.

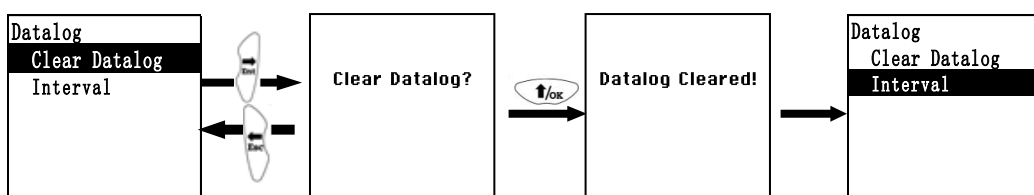
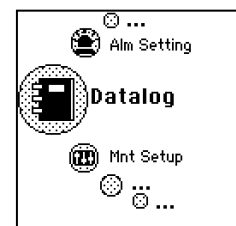

1. Press the Right key to clear the datalog. The display asks, 'Clear Datalog?'
2. Press the Left (Esc) key if you do not want to clear the datalog.
3. Press the Up key if you want to clear the datalog. When it has been cleared, the display shows 'Datalog Cleared!' and moves to the next sub-menu, Interval.

Interval

Intervals are shown in seconds. The default value is 60 seconds and the maximum is 3600 seconds (1 hour). There is enough data capacity to run for 6 days at 1-second intervals, 12 months at 60-second intervals, or 6 years at 10-minute intervals. Once the datalog is full, it cycles and begins to replace the oldest data.

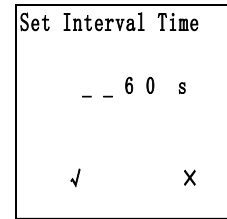

To change the Datalog Interval, press the Up or Mode key to increase or decrease each digit's value, and the Right or Left key to move the cursor. Then move the cursor to '✓' and press Up to save and exit.

Monitor (Mnt) Setup

Several settings can be accessed here, including date and time, pump parameters, display parameters and selecting 3-point calibration.

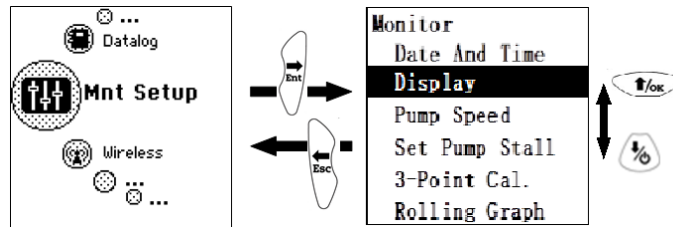

Date and Time

Date

The date is expressed as Month/Day/Year, with two digits for each. To change the date press the Up or Mode key to increase or decrease each digit's value, and the Right or Left key to move the cursor. Move the cursor to '✓' after the setting is complete, and press Up to save and exit.

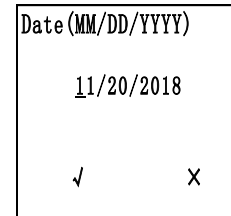

Time

The Time is expressed as Hours/Minutes/Seconds, with two digits for each. The time is in 24-hour (military) format. Adjust the time in the same manner as for the date.

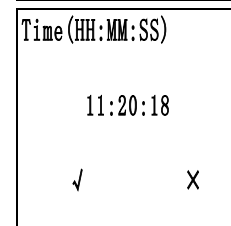

Display

The Display function is used to set LCD contrast and backlight.

LCD Contrast

The default LCD Contrast is about 50%.

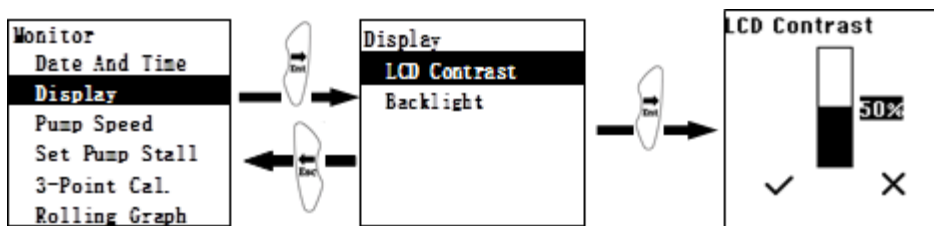

To change the contrast, press the Up or Mode key to increase or decrease the digit's value, then move the cursor to '✓' and press Up to save and exit.

Backlight

The Backlight can be set as Automatic, Manual or Off. In Automatic Mode the backlight comes on and stays on in low light conditions. In Manual Mode, pressing the Right or Left key turns the backlight on for one minute.

Pump Speed

The pump can operate at low or high speed, ranging from about 300 to 420 cc/min with no filters, respectively, 260 to 390 cc/min with a standard 0.45 µm filter in place, and about 240 to 350 cc/min with both a benzene tube and 0.45 µm filter. Running at low speed is quieter and conserves a small amount of power. There is almost no difference in sampling accuracy. High pump speed is recommended for faster response when using an extension hose to sample, or when measuring heavy compounds, which tend to have slow response because of adsorption on inlet surfaces.

NOTE: During benzene tube measurements, the set pump speed is over-ridden and automatically switched to high speed for the initial tube measurement and low speed for a follow-on STEL reading.

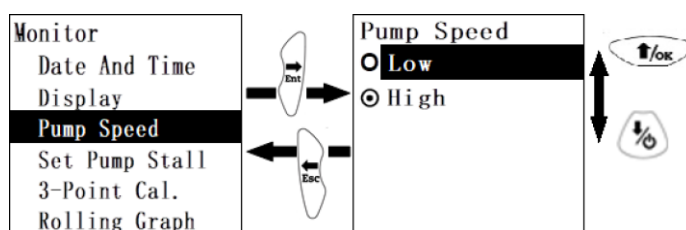

Use the Right key to enter Pump Speed, then Up or Mode to scroll on the list, Right to select, and Left to save and exit. Note that each Pump Speed has its own Stall Threshold.

Set Pump Stall Threshold

The Pump Stall Threshold is the current-draw setting for a blocked pump alarm. The default setting is 500 to 800, depending on model. The actual, real-time pump current draw is displayed in the upper right corner. Briefly block the inlet probe with a finger and observe the rise in pump current value. Set the stall threshold about 50-100 units above the unblocked pump reading, but lower than the blocked pump reading. Press the Up or Mode key to increase or decrease each digit's value, and the Right or Left key to move the cursor. Then move the cursor to '√' and press Up to save and exit. Set a different pump stall threshold for each pump speed.

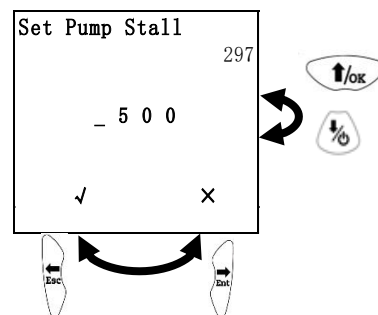

NOTE: For NEO Benz MP186, set the stall threshold with an open (used) tube in the holder to avoid a stall alarm when a tube is inserted for benzene measurements.

3-Point Calibration

Normally a 2-point calibration gives adequate linearity in PID response, but a 3-point calibration (Zero, Span 1 and Span 2) can be enabled for more accuracy, particularly in the high concentration range above about 500 ppm VOC where response is less linear. Use the Right key to enter 3-Point Cal, then Up or Mode to scroll to On or Off, Right to select, and Left to save and exit.

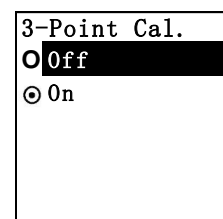

Below is the list of default 1st and 2nd Span points for each Measurement Mode. These settings can be changed in the Calibration menu.

Mode	Span	Span 2
VOC (Isobutylene)	10 ppm	1000 ppm
Benzene	5 ppm	50 ppm
Butadiene	5 ppm	50 ppm

Rolling Graph

If the Rolling Graph function is enabled, the display in basic User Mode shows the instantaneous reading together with a real-time plot of immediate past readings in a 2-minute window. Enable the rolling graph as with any other list selection menu.

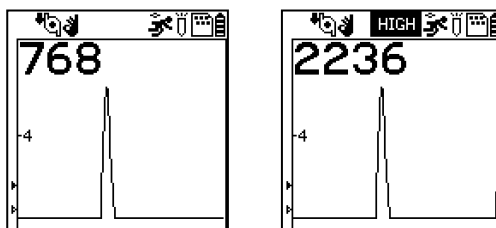

Real Time Data

Real time data output to a PC is available via a USB cable and/or wirelessly via Bluetooth Low Energy (BLE) using an Android App. Select 'On' in this menu and see Computer Interface section below for procedures.

Language

The display language can be selected as English, Simple Chinese, or Traditional Chinese. Chose the language as for any other list selection menu.

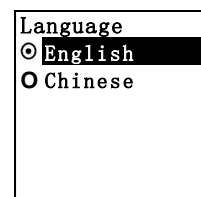

Self-Zeroing

With Self-Zeroing enabled, the instrument re-zeroes automatically if the signal drifts below the last Zero Calibration for some time. Such drift can occur 1) slowly as the lamp ages, 2) a dust or oil film accumulates on the lamp window, or 3) a change in environmental conditions such as background matrix gas, humidity or temperature. The default setting of self-zeroing is off. At the time of enabling self-zeroing, make sure the instrument is running in clear environment for several minutes to ensure that the baseline zero signal is well established. Enable this function as with any other list selection menu.

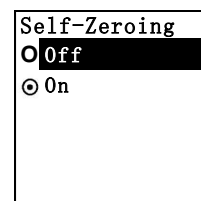

Temperature Unit

Select display temperatures in either °C or °F, including tube temperature for benzene sampling.

Operating Mode, User ID and Site ID

Select Hygiene Mode for standard measurements and Search Mode for LDAR measurements. Refer to the standard NEO manual for details on LDAR operating procedures, including User and Site IDs. Search Mode is operational only in VOC Mode and is non-functional in Tube Mode,

Tube Type

Use this menu to select Benzene or Butadiene operating modes. Note that each channel requires a separate zero and span calibration, and switching between these two modes or VOC mode does not require recalibration, once all three mode calibrations have been performed.

Wireless

Wireless radio communication can be enabled if the instrument has a wireless module installed. Enable this function as with any other list selection menu.

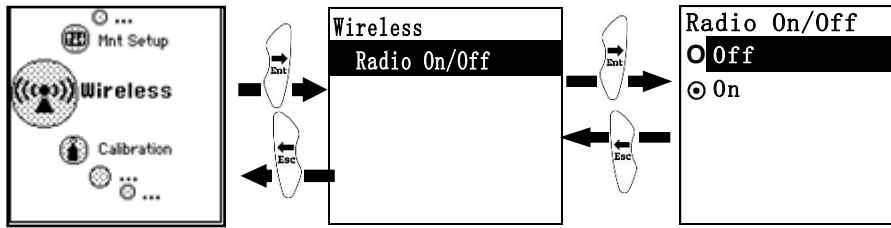

Computer Interface Using mPower Suite

The mPower Suite software can be used to 1) download logged data, 2) upload configuration parameters to the instrument, 3) monitor data in real time and 4) upgrade the instrument firmware. mPower Suite and instrument firmware can be downloaded from our website at <https://www.mpowerinc.com/software-downloads/>.

Connecting and Configuring

1. Turn on the instrument and press Up from VOC or Benzene Main Mode to go into PC comm.
2. Connect the USB cable to the PC and the Micro-USB end to the instrument.*
⚠WARNING! Connect only in non-hazardous environment!
3. Start mPower Suite on the PC and click the “Search” button to find the instrument.
4. Find the instrument in the left bar Device Connected list. Click on the S/N to get the configuration file from the instrument. To switch between VOC and Benzene configuration screens, change the instrument mode manually and then click “Read”.
5. Edit the configuration parameters as desired and click “Write” to upload the configuration to the instrument.
6. “Read” allows downloading the current configuration file from the instrument.
7. “Save” allows storing the current configuration file to the PC.
8. “Load” allows calling up a stored configuration file from the PC to mPower Suite.
9. To update the instrument firmware, select “Firmware Upgrade”. The firmware must first be downloaded to the PC from the mPower website www.mPowerinc.com.

*NOTE: Any locally-obtained USB A to Micro B USB cable will work for battery charging, but will not work for communication with mPower Suite software. The mPower USB cable P/N M-011-3003-000 is required for a PC to recognize the instrument and communicate with mPower Suite.

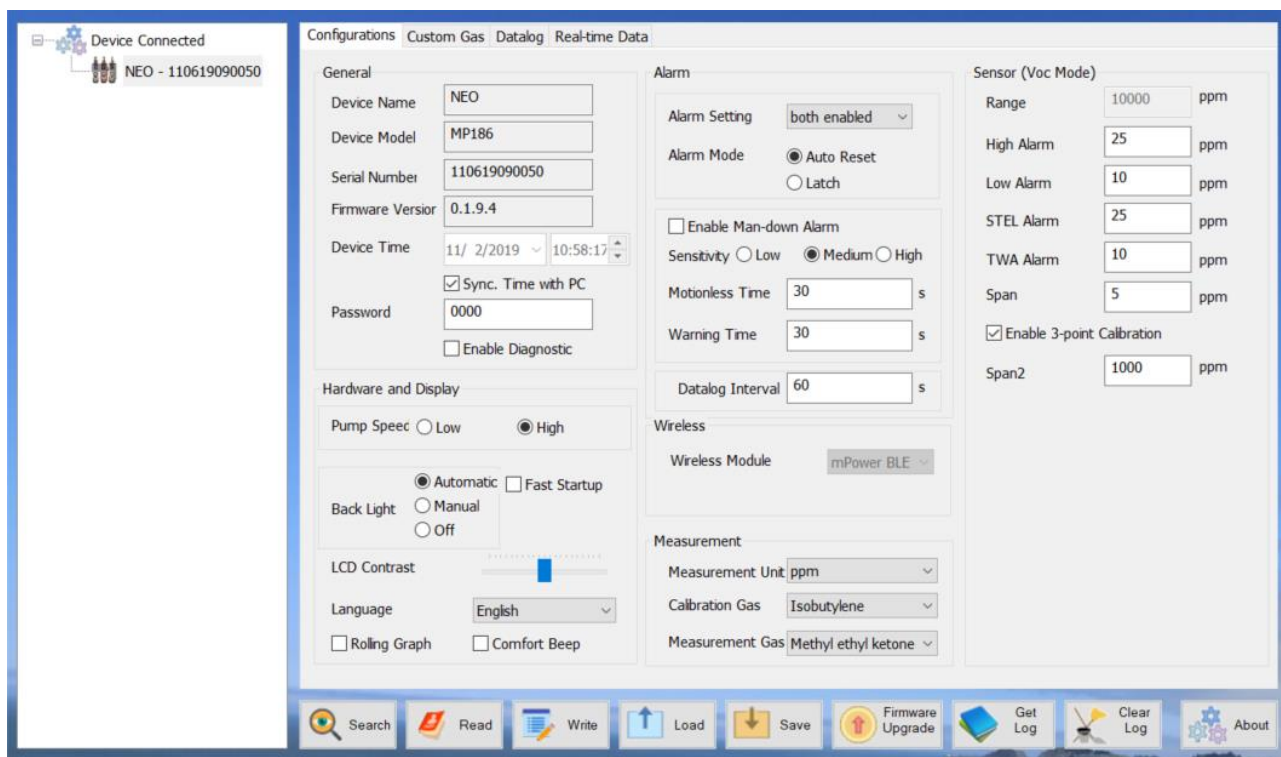

mPower Suite Configuration Screen for VOC Mode

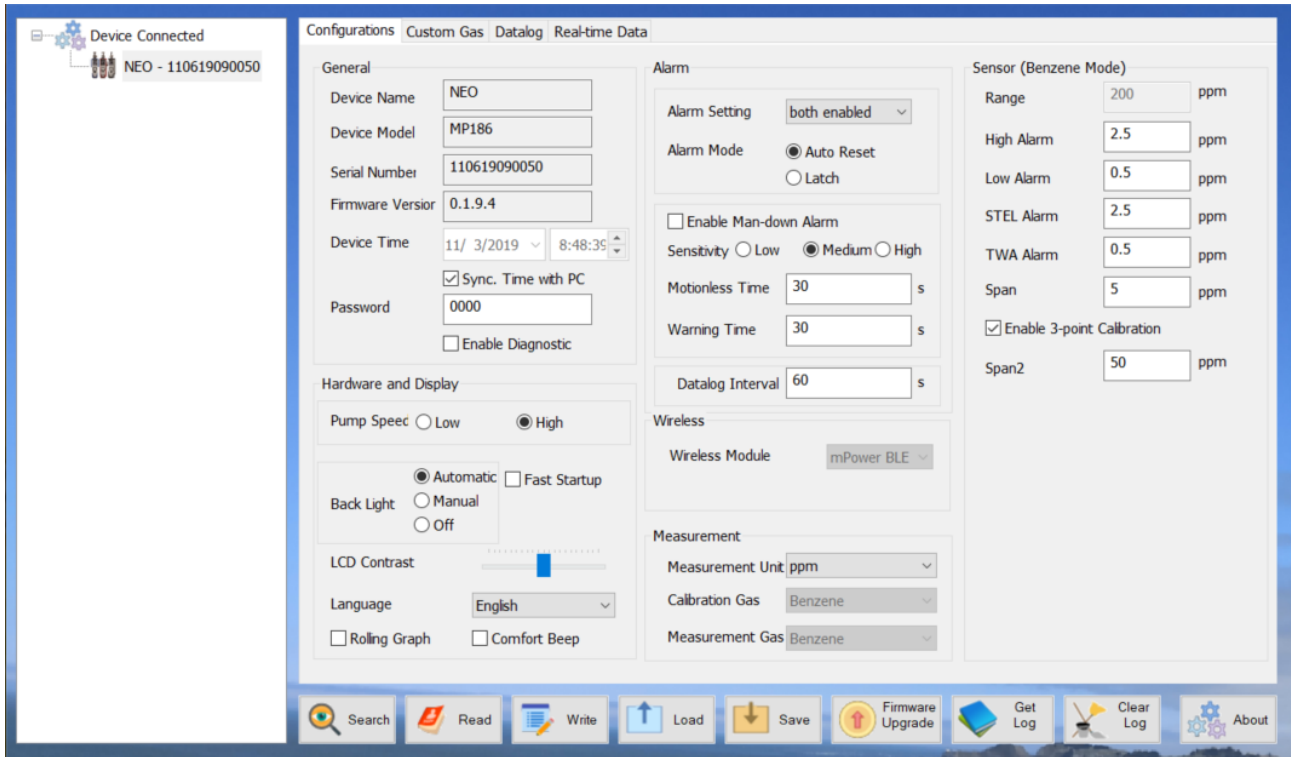

mPower Suite Configuration Screen for Benzene Tube Mode

Custom Gas (User Gas) in VOC Mode

1. **Calibration Gas** and **Measurement Gas** can be selected in VOC Mode from a list of a few hundred compounds. If the Measurement and Cal Gas are different, a correction factor is calculated and applied to make the sensor display in concentration equivalents of the measurement gas.
2. To set a **Custom Gas**, overwrite “Custom Gas 1” (User Gas 1) with the chemical name and press the ‘Return’ key. Enter the molecular weight (m.w.) and correction factor for a 9.8 eV PID lamp. The molecular weight is only needed when gas units of mg/m³ are used; if not, leave the m.w. at 0 or 1. By clicking the “Save User Gas” box on the right of the screen, the factors are sent to the instrument without sending any other configurations. The “Reset User Gas” button sets all values back to factory default on both the instrument and the mPower Suite panel.
3. Return to the Configuration screen, select the Custom/User Gas in the Measurement Gas menu, edit the alarm limits if needed, and click “Write” to ensure that the new gas is selected on the instrument.

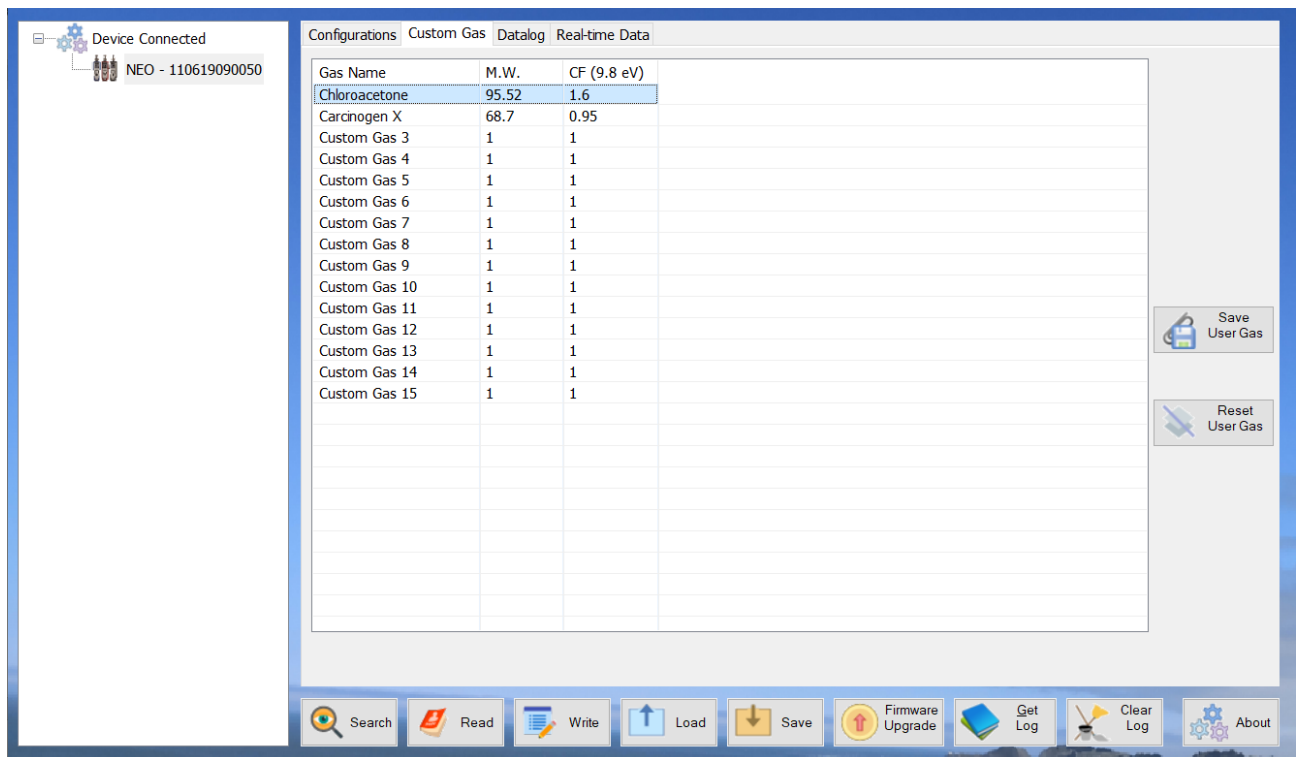

mPower Custom Gas Screen

Datalog Retrieval

1. To download the datalog from the instrument to the PC, select “Get Log”. This process can take several minutes because datalogging is always on and large files can be created. The datalog files will appear under the “Datalog” tab on the top of the screen. Below is a sample screen of datalog information listing sample time and instantaneous reading. A new Single Datalog file is created each time the instrument is turned on or the configuration is changed. The middle panel shows the file start time and number of data points.
2. To export data to a csv file readable by Excel or other spreadsheet software, move the cursor over the right data panel and click the right mouse button, and then select either the current Single Datalog file or all the stored data (Whole Datalog).

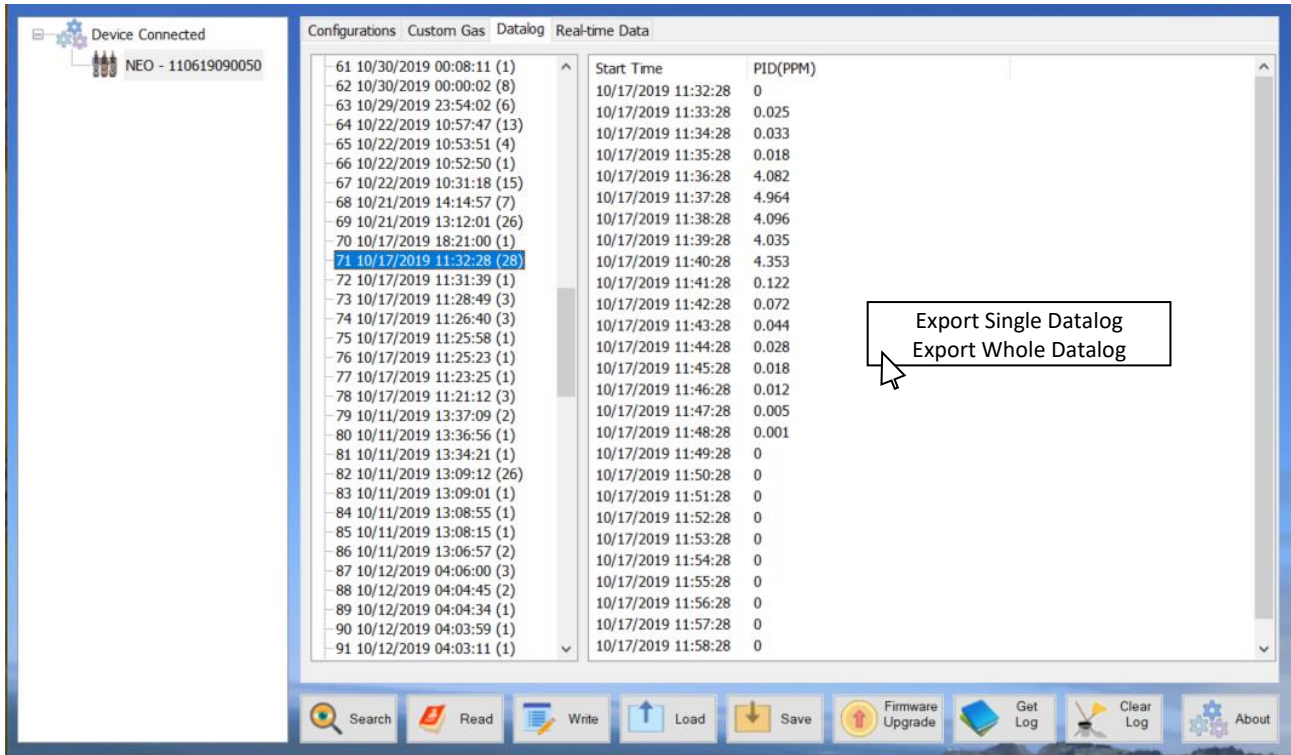

mPower Suite Datalog Screen

Real-time Data

1. (This function requires mPower Suite version 1.1.0.114 or later with NEO firmware v.1.9.1 or later.)
2. To display a list of readings in real time, click on the “Real-time Data” tab on the top of the screen. Enter the desired reading time interval, select a folder on the PC for storing the data, and create a file name.
3. Ensure that the NEO is connected and click “Start” to begin real-time monitoring. To visualize the data in real time on the instrument at the same time that they appear on the PC list, one can select the Rolling Graph option in the Monitor Set-up configuration. Select “Stop” when finished and “Clear” to discard the data when no longer needed.
4. The data should be available as an Excel-readable .csv file in the folder selected. To separate the data into columns in Excel, click on the “Data” menu on top and select “Text to Columns” to convert.

WARNING!

Safety certificates for hazardous locations are invalid when the NEO is operated with a cable connected to a computer or any other device. Perform real-time data transfers only in areas known to have no risk of explosion hazard.

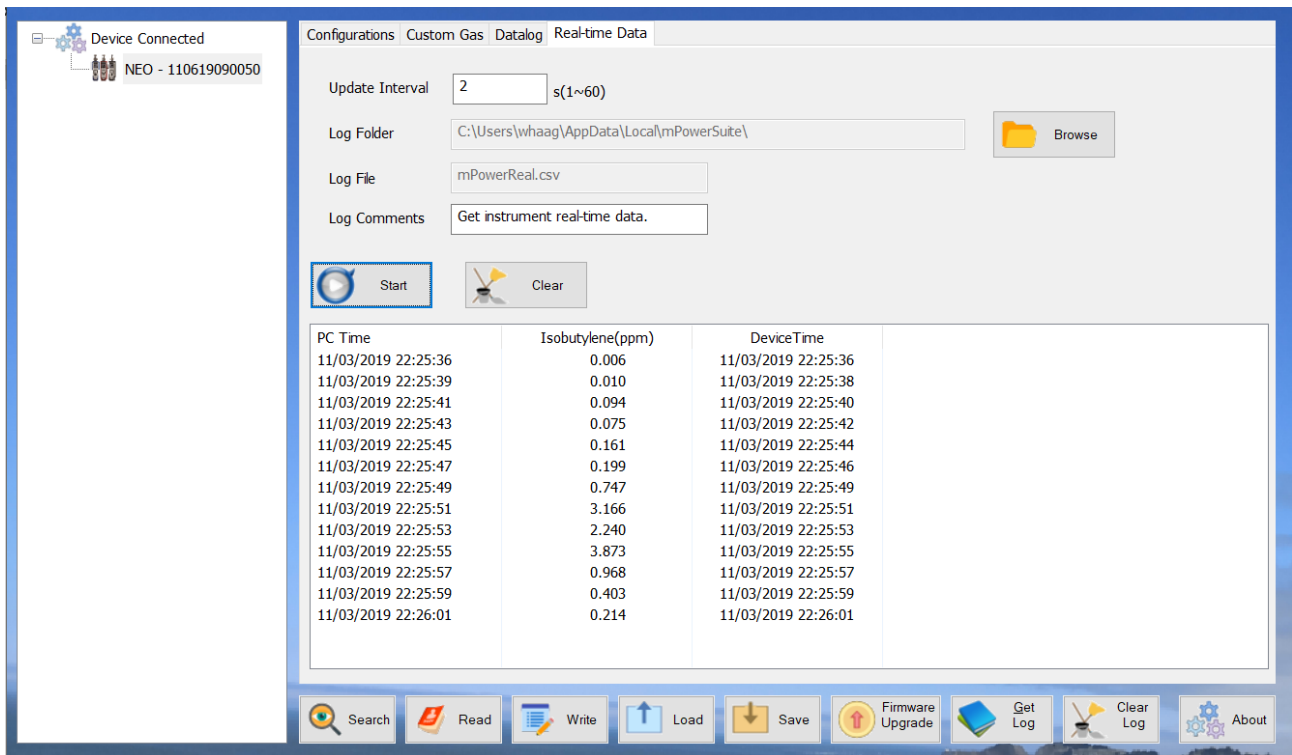

Device Connected
NEO - 110619090050

Configurations Custom Gas Datalog Real-time Data

Update Interval s(1~60)

Log Folder

Log File

Log Comments

PC Time	Isobutylene(ppm)	DeviceTime
11/03/2019 22:25:36	0.006	11/03/2019 22:25:36
11/03/2019 22:25:39	0.010	11/03/2019 22:25:38
11/03/2019 22:25:41	0.094	11/03/2019 22:25:40
11/03/2019 22:25:43	0.075	11/03/2019 22:25:42
11/03/2019 22:25:45	0.161	11/03/2019 22:25:44
11/03/2019 22:25:47	0.199	11/03/2019 22:25:46
11/03/2019 22:25:49	0.747	11/03/2019 22:25:49
11/03/2019 22:25:51	3.166	11/03/2019 22:25:51
11/03/2019 22:25:53	2.240	11/03/2019 22:25:53
11/03/2019 22:25:55	3.873	11/03/2019 22:25:55
11/03/2019 22:25:57	0.968	11/03/2019 22:25:57
11/03/2019 22:25:59	0.403	11/03/2019 22:25:59
11/03/2019 22:26:01	0.214	11/03/2019 22:26:01

Search Read Write Load Save Firmware Upgrade Get Log Clear Log About

mPower Suite Real-time Data Screen

Maintenance

Cleaning or Changing PID Sensor/Lamp

Lamp Cleaning and Changing

1. Unscrew the Sensor Cap and pull the sensor straight out, using a slight rocking motion if necessary.
2. Put on finger gloves and pull out the lamp. Insert a new lamp, or clean the existing lamp as described below.
3. Use a cotton swab wetted with methanol to clean the flat window surface of the lamp. If greasy dirt is hard to remove using methanol, the window can be polished using fine alumina powder polishing paste.
4. Use a clean tissue to wipe the lamp window again.
5. Re-insert the cleaned lamp, plug in the sensor and screw on the sensor cap.
6. Always re-calibrate the PID after cleaning the lamp and/or sensor.



Sensor Cleaning

1. Unscrew the sensor cap.
2. Pull the sensor straight out, using a slight rocking motion if necessary.
3. Put the sensor into a beaker and cover it with pure methanol or ethanol.
4. Put the beaker into an ultrasonic cleaning bath and sonicate for 15 minutes. Then take out sensor and dry it. Shake the sensor vigorously to remove excess liquid and if possible, use a gentle stream of clean air to blow the residual liquid out of the sensor.
5. Always re-calibrate the PID after cleaning the sensor.



Sampling Pump

The flow rate should be roughly 250-350 cc/min at low pump speed and 350-450 cc/min at high pump speed when there is no air leakage (and no tube in the holder). When approaching the end of its useful operating life, the pump will consume more energy and draw significantly lower flow. Also, if excessive dust or particles enter the pump, the flow will be reduced. A strong pump should stall and/or nearly stop when a finger is used to block the inlet. If the pump does not stall but the flow is weak, it is likely that particles are trapped in the pump diaphragm. When this occurs, it is necessary to replace or rebuild the pump, or clean the diaphragm. Repair of the pump requires removal of the circuit board and must be done by an authorized service center.

Troubleshooting

Problem	Possible Reasons	Solutions
Cannot turn on power after charging the battery	Defective battery.	Call authorized service center to replace battery
Reading abnormally High	Dirty Filter.	Replace filter.
	Dirty sensor module.	Clean or replace sensor module.
	Excessive moisture or water condensation.	Blow-dry the sensor module.
	Incorrect calibration.	Calibrate the unit.
	Benzene tube saturated.	Use new benzene tube.
Reading abnormally Low	Dirty filter.	Replace Filter.
	Dirty sensor module.	Clean or replace sensor module.
	Weak or dirty lamp.	Clean or replace lamp.
	Incorrect calibration.	Calibrate the unit.
	Benzene tube gasket leaks	Replace entire tube holder
Buzzer inoperative	Buzzer disabled	Check that buzzer is not turned off.
	Bad buzzer	Call authorized service center.
Inlet flow too low	Pump diaphragm damaged or has debris.	Call authorized service center.
	Flow path leaks.	Check flow path for leaks; e.g., sensor module O-ring, tube holder connectors, Teflon tubing compression fitting.
“Lamp” alarm on during operation	Lamp drive circuit.	Turn unit off and back on, or take lamp out and put it back.
	Weak or defective PID Lamp.	Replace UV Lamp.
PC does not recognize instrument	Wrong cable	Use mPower USB cable P/N M-011-3003-000.

Contact Information

mPower Electronics Inc.

3046 Scott Blvd. Santa Clara, CA 95054 USA

Phone: (408) 320-1266

Toll Free: (866) mPower7 (866) 676-9377

Fax: (669) 342-7077

info@mpowerinc.com

www.mpowerinc.com

