

VOXI

Fixed Photo-ionization Detectors

MP812 & MP815

User's Guide



Contents

- 1. General Information 5**
 - 1.1 Key Features.....5
- 2. User Interface 6**
- 3. Installation 7**
 - 3.1 Mounting7
 - 3.2 Rain Cap.....8
 - 3.3 Electrical Connections9
- 4. Operation Overview 11**
 - 4.1 Standard Operation11
 - 4.2 Programming and Calibration11
- 5. Operations By Mobile Phone or Tablet..... 11**
 - 5.1 Hardware and Software Requirements.....11
 - 5.2 Connecting the VOXI to the Mobile Device12
 - 5.3 Operation Shortcut Buttons and Overview12
 - 5.4 Field Service (Calibration, etc.).....13
 - 5.5 VOXI Settings16
 - 5.6 View Operations Log.....17
- 6. Operations By Handheld Remote Programmer 18**
 - 6.1 Battery Installation18
 - 6.2 User Interface.....18
 - 6.3 Menus and Sub-menus.....19
- 7. Maintenance 21**
 - 7.1 Replacing Filters.....21
 - 7.2 Removing/Cleaning/Replacing Lamp and Sensor21
 - 7.3 Replacing Pump23
- 8. Troubleshooting 24**
 - 8.1 4-20 mA Alarm Signals.....24
- 9. Technical Specifications 25**

Read Before Operating

This manual must be carefully read by all individuals who have or will have the responsibility of using, maintaining or servicing this product. The product will perform as designed only if it is used, maintained and serviced in accordance with the manufacturer's instructions. The user should understand how to set the correct parameters and interpret the obtained results.

WARNINGS !

- Never operate the monitor when the cover is removed.
- Remove the monitor cover only in an area known to be non-hazardous.
- Use only mPower's sensor and accessories. Substitution of components will impair suitability for intrinsic safety and void warranty.
- The instrument should be calibrated after installation before initial use and checked by exposing it to a known concentration calibration on a regular basis.
- Ensure that the gas inlet is not blocked.
- Make sure that all filters are clean and replaced on a regular basis.
- Remove the sensor only if necessary for repair. Zero and span calibration are required once the sensor is moved.

Special Conditions for Safe Use

The VOXI monitor must be calibrated if it does not pass a bump test, when a new sensor has been installed, or at least once every 180 days, depending on use and sensor exposure to poisons and contaminants.

1. General Information

The VOXI is one of the most advanced fixed monitors available for ppb (parts per billion) detection of VOC (Volatile Organic Compound). It operates on 12-30 VDC power and provides various outputs including OLED digital read-out, 4-20 mA analog output, RS-485 digital output, CAN or Modbus, 3 relays, and one port to an external strobe or horn. The VOXI offers two models that measure from low ppb to a high range up to 5000 ppm for different applications. Novel designs of the photo-ionization detector (PID) and ultraviolet (UV) lamp provide outstanding sensitivity, stability and reproducibility. An on-board heater prevents condensation at low temperatures. Configuration and testing is performed conveniently using a mobile App and Bluetooth controller. Options include real time remote monitoring with a built-in wireless modem using mPower Suite application software.

1.1 Key Features

- VOC emissions monitoring using innovative PID for performance & long life
- 700 integrated gas correction factors
- 0.001-200 ppm (MP812) and 0.01-5000 ppm (Mp815) ranges of VOC
- Outstanding linearity over full measurement range
- Auto-ranging and auto-zeroing
- 5-second response time for 90% change (using isobutylene)
- Built-in pump for up to 30 meters sampling distance
- Size: 8.4 x 7.1 x 5.0 in (213 x 180 x 127 mm)
- Weight: 3.3 lbs. (1.5 kg)
- 12-30 VDC power input
- OLED display for maximum visibility outdoors
- 3 Relays, 4-20 mA, RS-485 and output to alarm strobe or horns
- Mobile App and Bluetooth controller for handy configuration and testing
- Wide temperature range of -40° to +70°C (-40° to 158°F) with built-in heater to prevent condensation
- Rugged, explosion-proof housing with IP-66 rating
- Real-time remote wireless monitoring and alarm notification option

2. User Interface

The VOXI user interface consists one large OLED Display showing the gas concentration, one status LED, two alarm LEDs, and various status icons. Calibration and other parameters are programmed using the mPower Suite mobile App on a smart-phone or tablet.

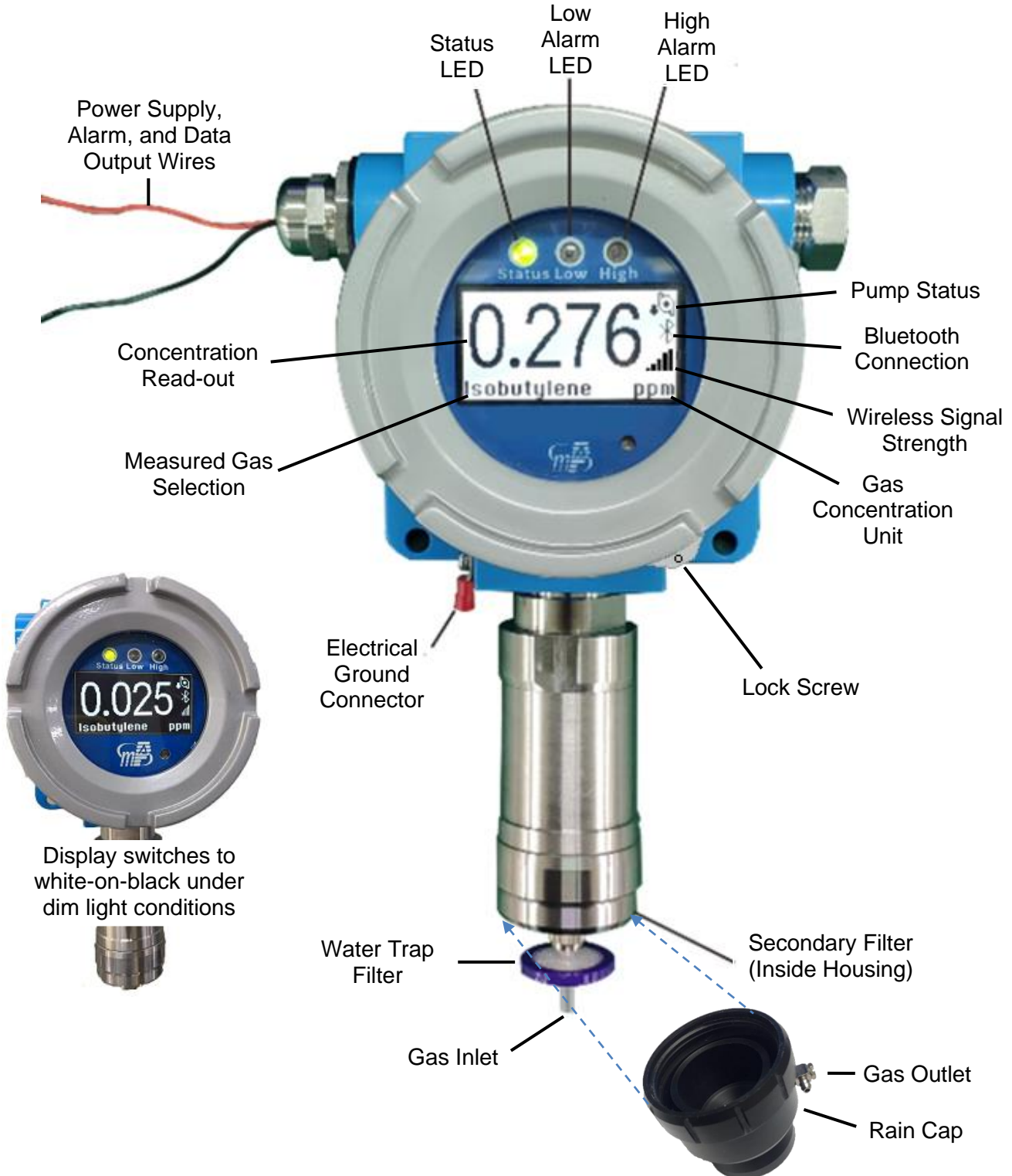

3. Installation

WARNING !

- The VOXI is currently not certified for use in hazardous gas locations. Install this unit only in an area known to be free of combustible gases and vapors.
- Before installation, ensure that all power is disconnected.
- Before removing the monitor cover for service, disconnect the power supply and ensure that the area free of combustible gases and vapors.
- For European locations, installation must comply with EN-60079-14.
- The instrument should be calibrated after installation before initial use and checked by exposing it to a known concentration calibration on a regular basis.
- Remove the sensor only if necessary for repair. Zero and span calibration are required once the sensor is moved.

3.1 Mounting

3.1.1 Mounting Location

For safety and ease of maintenance, the VOXI should be installed in a non-hazardous-gas location.*¹ Extension tubing of up to 100 feet (30 m) can be attached to the inlet to allow remote mounting if the sampling location contains flammable or toxic gas mixtures.

3.1.2 Mechanical Mounting Options

The VOXI is designed for wall mount or pole mount using the screw-holes provided, centered 5.25 inches or 134 mm apart. If mounted outdoors, ensure that the gas inlet is directed downwards to minimize the chance of precipitation being drawn into the PID.

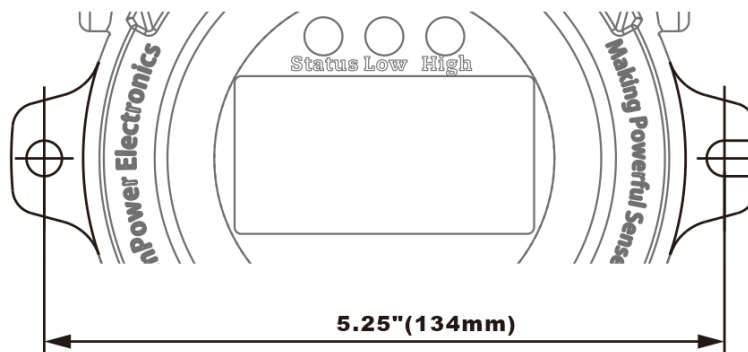

*¹ Future VOXI versions that have certifications will be able to be installed and operated in hazardous-gas locations, but because the housing cannot be opened for service in the presence of flammable gases, the VOXI is easier to maintain if installed in a non-hazardous location or one that can be vented to remove hazardous gases before opening the housing.

An optional mounting bracket (P/N M008-3004-000) is available that allows the unit to be offset about 1 cm from the wall or pole.

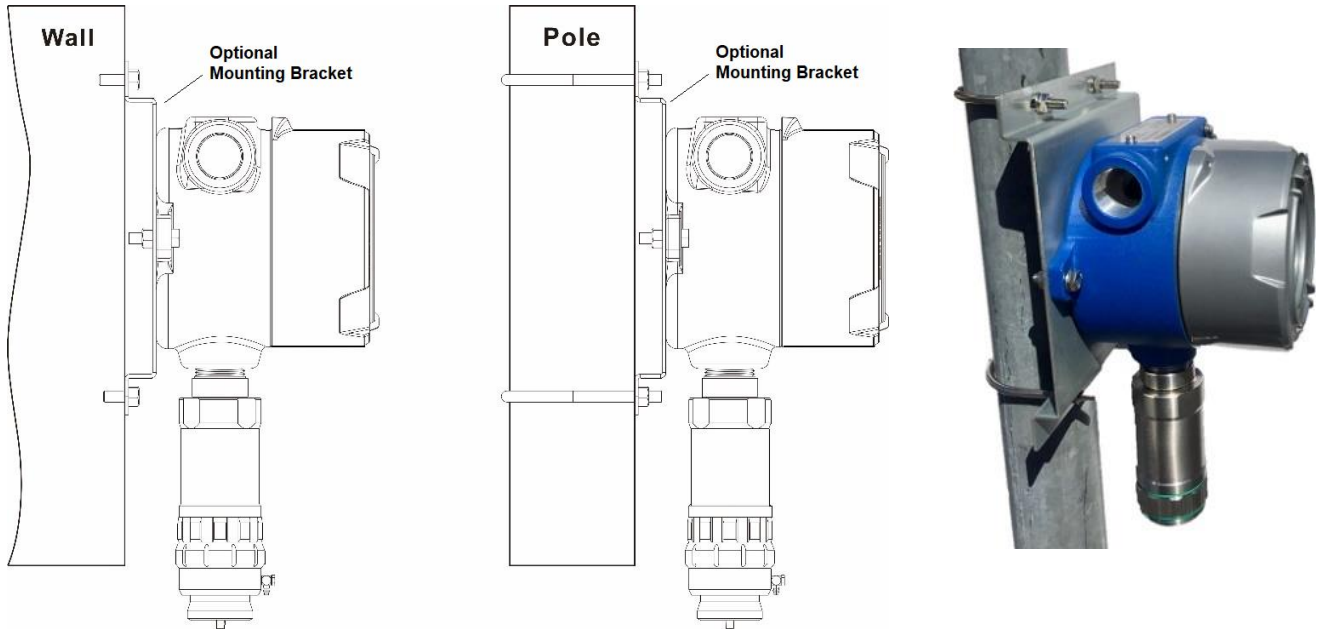

3.2 Rain Cap

If mounted outdoors, the rain cap can be installed to further reduce the chance of precipitation ingress. This cap also allows connection of tubing to the gas outlet if it is desired to vent the exhaust away from the VOXI instrument.



3.3 Electrical Connections

Two conduit holes are provided in the explosion-proof housing, one covered by a hex-head plug and the other for wire connections. To unscrew and remove the cover, first loosen the lock screw located on the side, using an Allen wrench. Pinch the buckles on both sides of the instrument assembly to release and then lift it out. Unplug the three terminal block plugs on the PC board.



The schematic below shows the internal wiring connections. Insert the wire through the conduit hole and connect to the corresponding pin numbers of the three terminal blocks on the bottom of the assembly. These blocks accept 12AWG to 24AWG wire (0.2 to 4.0 mm²). Input power requirements are <math>< 5W</math>, 12-30 VDC and should be connected between Terminals 14-GND and 15-V+. An external ground wire (AWG11 recommend) must be connected to the VOXI housing.

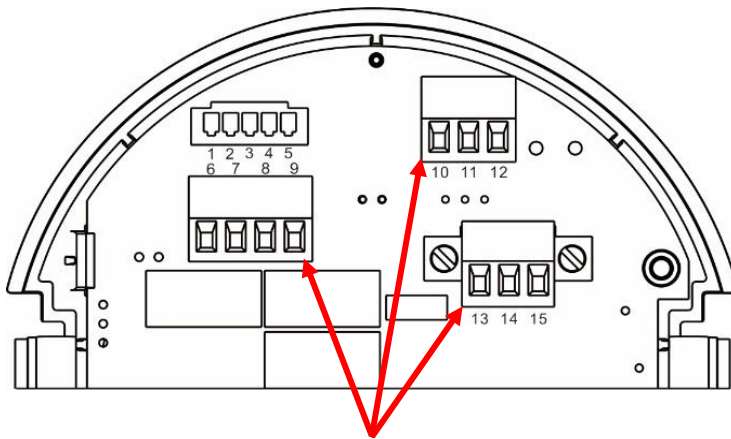

Terminal Blocks

1	2	3	4	5	6	7	8
ALARM HIGH	ALARM LOW	ALARM FAULT	NC	+V	ALARM HIGH	ALARM LOW	ALARM FAULT

9	10	11	12	13	14	15
COM	RS 485A	GND	RS 485B	4-20mA OUTPUT	GND	+V

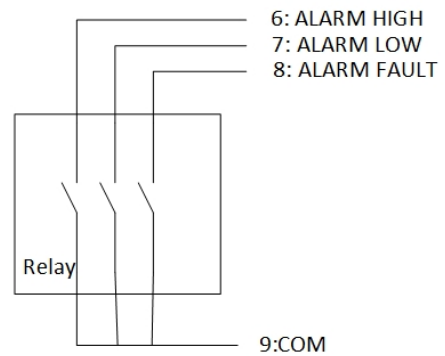

Alarm outputs on Terminals 6-9 are normally-open dry contacts that close on alarm. The 4-20 mA output should be connected to Terminals 13 and 14. RS485 should be connected to terminals

10 & 12, and terminal 11 is for the RS485 shielding line. The +V terminals 5 and 15 are equivalent and internally connected, as are GND terminals 11 and 14.

3.3.1 Baseline 4 mA Signal Adjustment

If sending the 4-20 mA signal to a remote controller, during the field installation the VOXI analog output should be adjusted. See VOXI Field Service section below for procedures.

3.3.2 MODBUS Message RTU Framing

The VOXI uses RTU framing for MODBUS messages. The following is an excerpt of the *MODBUS over Serial Line Specification and Implementation Guide v1.02 (Dec.2006)* with more information available at <http://www.modbus.org/> and <http://www.modbus.org/specs.php> :

A MODBUS message is placed by the transmitting device into a frame that has a known beginning and ending point. This allows devices that receive a new frame to begin at the start of the message, and to know when the message is completed. Partial messages must be detected and errors must be set as a result. In RTU mode, message frames are separated by a silent interval of at least 3.5 character times. In the following sections, this time interval is called t3.5.

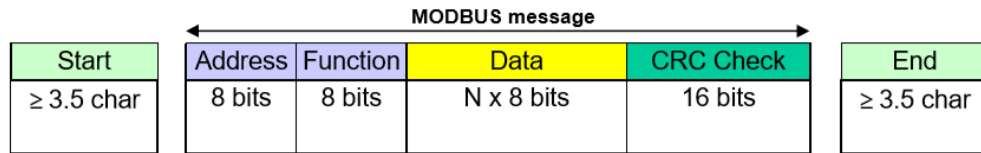
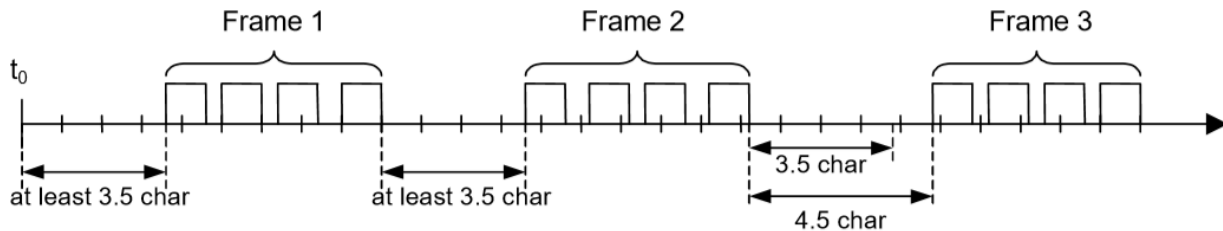

RTU Message Frame

The entire message frame must be transmitted as a continuous stream of characters. If a silent interval of more than 1.5 character times occurs between two characters, the message frame is declared incomplete and should be discarded by the receiver.

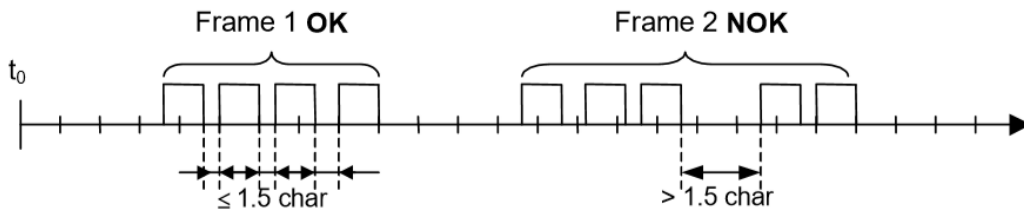

Remark : The implementation of RTU reception driver may imply the management of a lot of interruptions due to the t1.5 and t3.5 timers. With high communication baud rates, this leads to a heavy CPU load. Consequently these two timers must be strictly respected when the baud rate is equal or lower than 19200 Bps. For baud rates greater than 19200 Bps, fixed values for the 2 timers should be used: it is recommended to use a value of 750 µs for the inter-character time-out (t1.5) and a value of 1.750 ms for inter-frame delay (t3.5)

4. Operation Overview

4.1 Standard Operation

Once installed and power is turned on, the VOXI runs continuously to measure VOCs, display the concentration readout and any alarms (flashing LEDs), and send any output and alarm signals connected to external devices. The pump runs intermittently when VOCs are below 500 ppb, in order to extend the life of the filters and the pump itself, but runs continuously above this threshold. The VOXI has an on-board heater which turns on at low temperature to reduce the possibility of condensation in the PID sensor. Both the VOC threshold and temperature threshold are set at the factory and cannot be adjusted by the user. Other operating parameters are set with a remote programming device.

4.2 Programming and Calibration

Configuring and calibrating the VOXI can be done using either 1) a mobile phone or tablet for the full range of settings or 2) the handheld remote programmer for a more limited set of parameters. There is no magnetic key or other means of programming the VOXI directly.

WARNING !

- VOXI VOC monitoring is turned off during communication with external devices.
- An intrinsically safe mobile device may be needed for use in hazardous gas locations. Otherwise, perform programming and calibrations only during times known to be free of combustible gases and vapors.

5. Operations By Mobile Phone or Tablet

5.1 Hardware and Software Requirements

An external mobile phone or tablet is required as a controller to program operating parameters. Currently Android 6.0 or higher platforms are supported. Updating to the latest Android version is common practice and recommended. Use an Ex (Intrinsically safe) Android device if operating in hazardous environments. Operation requires the mPower Suite Android App. If not already installed, it can be downloaded at <https://www.mpowerinc.com/software-downloads/> . The Controller allows users to:

- Get and set VOXI configurations
- Perform calibrations
- Adjust the analog 4-20 mA output baseline
- Adjust the pump stop threshold
- Join an mLink wireless system

5.1.1 Supported Languages

English and Chinese.

5.2 Connecting the VOXI to the Mobile Device

The system communicates wirelessly using Bluetooth Low Energy (BLE) signals when within 10 m (33 feet) distance.

1. To connect start the App, click on  to search for nearby devices, and click the device name.
2. Repeat to connect all the instruments. Up to 8 instruments can be connected to one Android device.

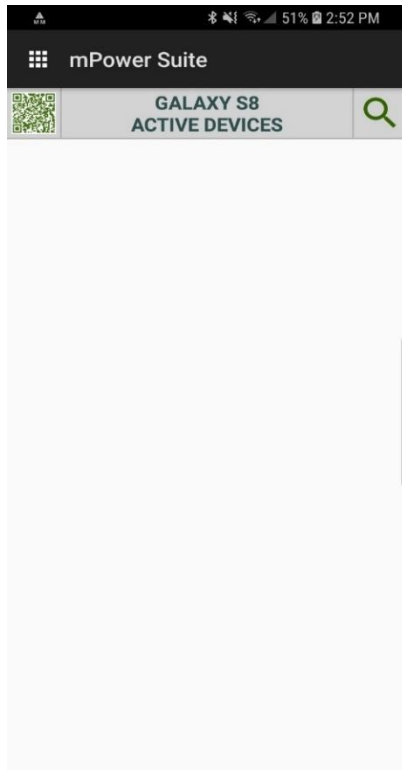

Search for nearby devices





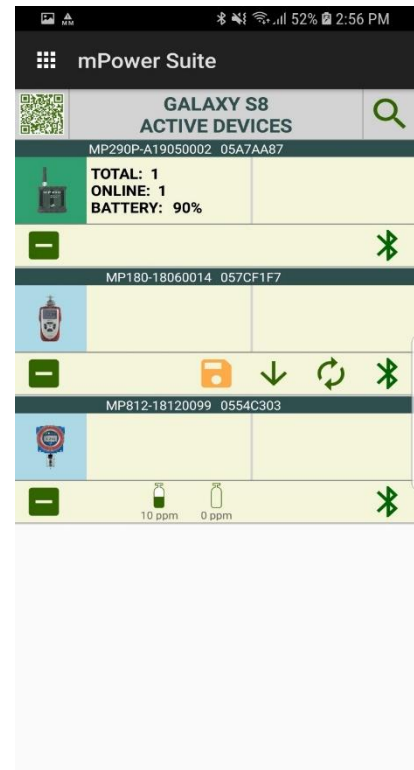

Click on the device name to connect



Connect up to 8 instruments and show Device Panels. Shortcut buttons on bottom of each panel.

5.3 Operation Shortcut Buttons and Overview

From the Active Device panel, click the shortcut buttons in the panel immediately below the instrument icon to execute some frequent operations, without going into detailed operation menus. The VOXI shortcut buttons are:

-  Disconnect
-  SPAN Calibration
-  Zero Calibration
-  Verifies Bluetooth connection

If the Bluetooth connection is lost, the device panel will be grey. Clicking on Bluetooth Connection Status will attempt to reconnect.

To enter the VOXI operations submenus, click on the device icon or the blank area to its right. VOXI operations include “Field Service”, “Settings” and “Operations (Log)”. The App automatically enters the "Field Service" screen.

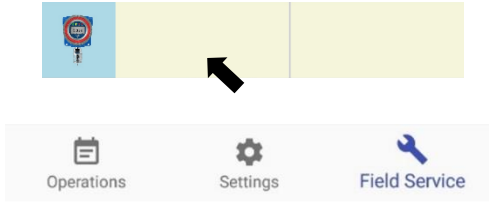

5.4 Field Service (Calibration, etc.)

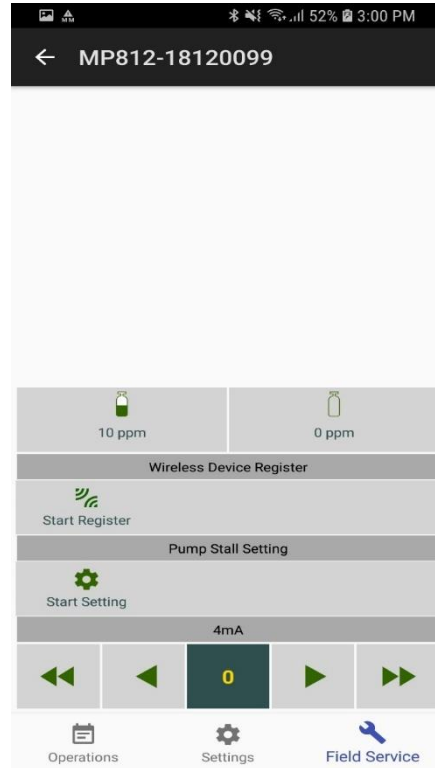

VOXI field services include

- Calibration
- Pump stop threshold setting
- 4 mA Analog output baseline setting.
- Wireless device registration



VOXI Operations main screen

5.4.1 Calibration

1. Initiate a **Zero Calibration** by clicking on the  icon. When prompted, supply clean air to the inlet and click 'Yes' to start the count-down timer. If the VOXI is mounted in an area where ambient air contains detectable VOCs, provide a clean air source a) by attaching a charcoal filter, b) attaching a gas bag (e.g, Tedlar® bag) filled with about 1 liter of clean air from a cylinder, or c) clean air directly from a cylinder fitted with either a demand-flow regulator or a fixed-flow regulator of about 0.5 LPM.
2. Before zero or span calibration, it is good practice to examine the water trap filter and large secondary filter inside the housing for cleanliness and replace as needed.
3. Initiate a **Span Calibration** by clicking on the  icon. When prompted, supply span gas to the inlet and click 'Yes' to start the count-down timer. Span gas can be supplied either from a gas bag (e.g, Tedlar® bag) filled to at least 1 liter, or directly from a gas cylinder fitted with either a demand-flow regulator or a fixed-flow regulator of about 0.5 LPM.
4. The **Zero or Span Calibration** can be **aborted** at any time during the countdown by click on the gas bottle icon again while it is red.
5. Use of fixed-flow regulators below 0.5 LPM or above about 0.6 LPM will cause poor calibration. A regulator with flow higher than 0.6 LPM can be used if an open T fitting is placed in line between the regulator and VOXI inlet to allow excess gas flow to escape without being forced through the instrument.
6. The **Calibration Interval** must be defined by the user because it depends on the application and local conditions. We recommend starting with weekly bump tests to check the response of the PID and need for filter changes, and then increasing the length of time between checks and calibrations as experience is gained in the application. We recommend no longer than 6-month intervals between calibrations.

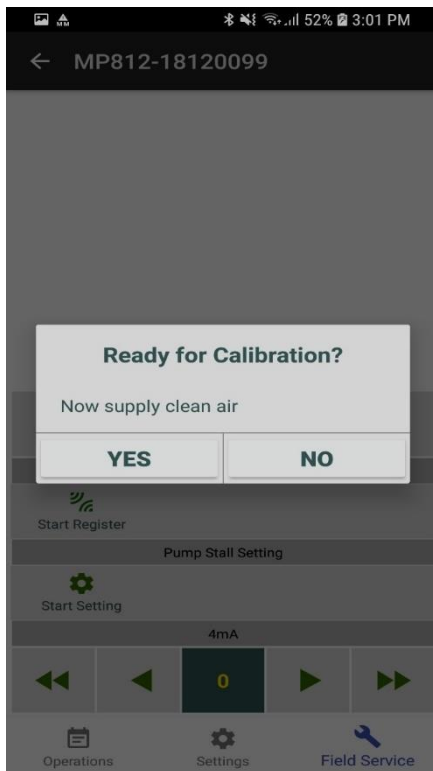

Zero Calibration screen

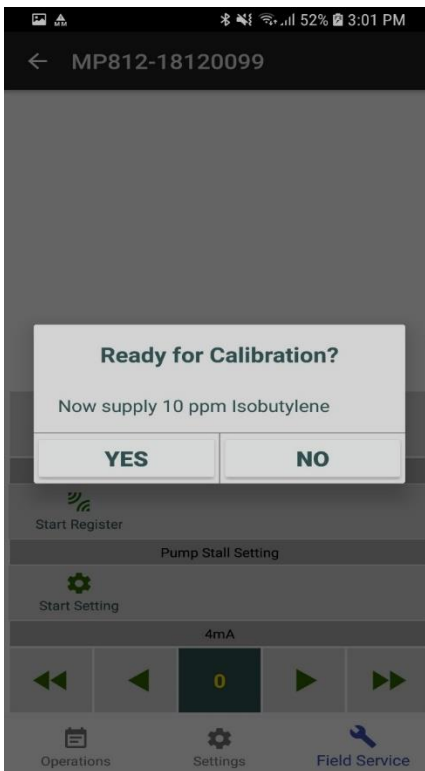

Span Calibration screen

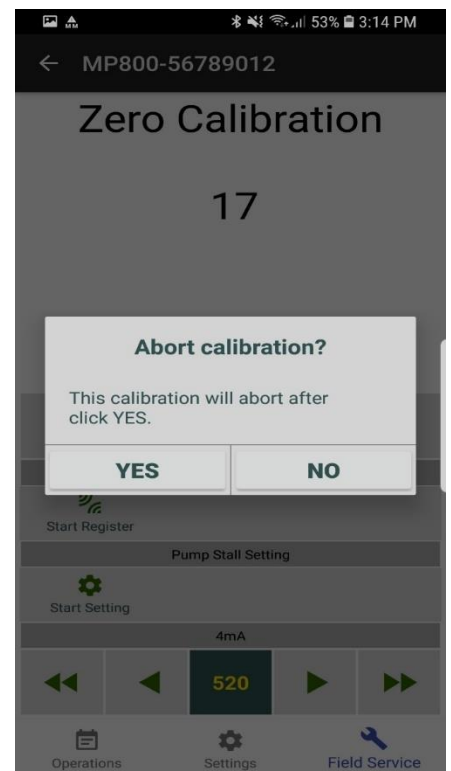

Aborting a Calibration

5.4.2 Configure Pump Stall Threshold





This feature protects the pump from burning out if there is a flow blockage that is causing excessive strain on the pump. Click "Start Setting"  to show the pump current draw. Then block the inlet and observe the current draw again. Enter the average value between the blocked and unblocked pump, and click "Set and Exit" to write the updated threshold to the VOXI. If this threshold is exceeded, the pump will stop and an alarm signal sent.

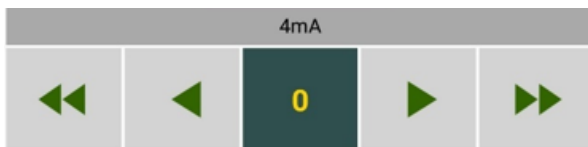

5.4.3 Configure 4 mA Output Baseline

If sending the 4-20 mA signal to a remote controller, during the field installation the VOXI analog output baseline should be adjusted. Click the button under "4 mA" to set the output. The default values are 520 counts for 4 mA (0 ppm) and 2630 counts for full scale. Click the increase and/or decrease buttons to adjust the raw count output (sent to the VOXI immediately) to read 4 mA on the controller with no gas present.



- : Click +1; Long Click +10.
- : Click +100; Long Click +1000.
- : Click -1; Long Click -10.
- : Click -100; Long Click -1000.

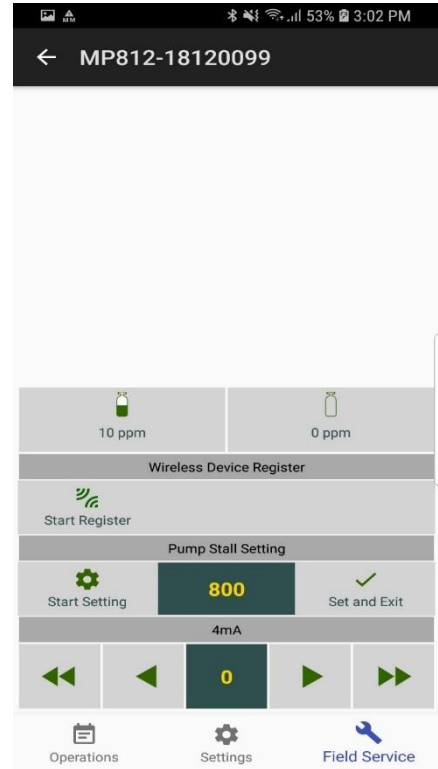

5.4.4 Wireless Registration

The VOXI can be connected (registered) to a wireless network for communication up to 2 miles (3 km) away using an mLink modem. First, put the mLink in the "Register Device" mode (NOTE: this requires a separate mobile phone or tablet dedicated to the mLink). Then click the "Start Register" button on the App to register this VOXI to the mLink. Registration should be completed immediately, and the results displayed in the pane to the right of the button.

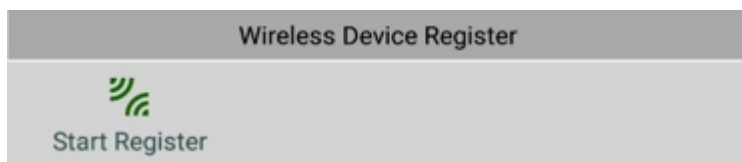

5.5 VOXI Settings

In the Settings menu the user can adjust various parameters such as

- Alarm limits
- Span gas type and concentration
- Measurement gas type
- Measurement concentration unit
- Modbus ID
- Wireless baud rate

NOTE: Firmware cannot be updated by the user.

From the main screen bottom panel click on the 'Settings'  icon and then click "GET" to display the VOXI configurations. After modifying the settings, click the "SET" button to send the modifications to the VOXI.

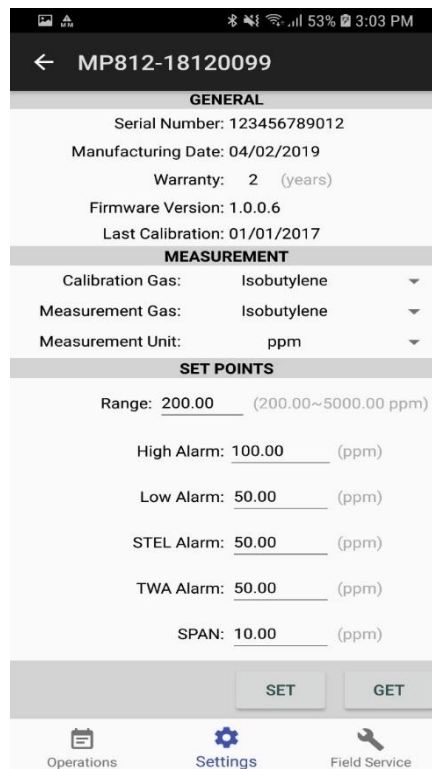
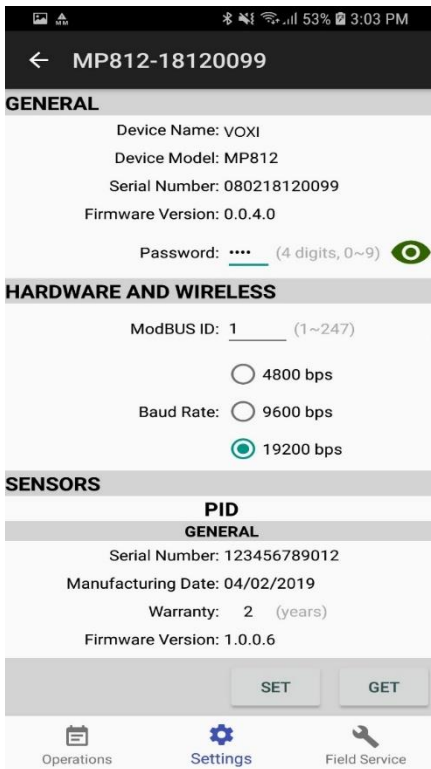
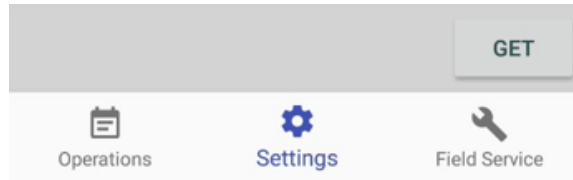

5.6 View Operations Log

Click "Operations" and select the date from the list at the bottom to view the daily operation log.

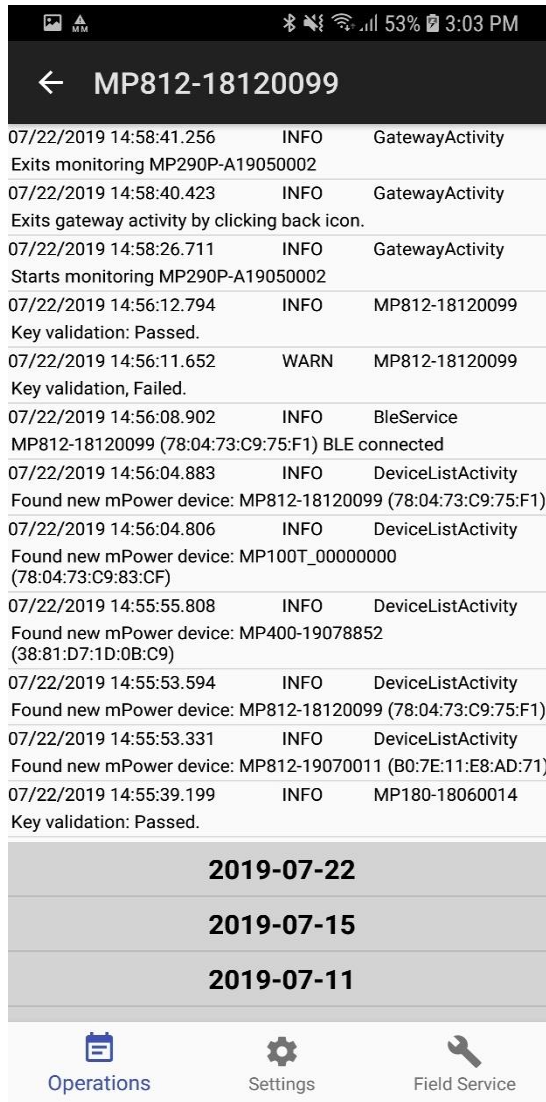

6. Operations By Handheld Remote Programmer

6.1 Battery Installation

Two AAA batteries are required but not included due to shipping limitations. To remove the battery cover, place the unit face down and use a thin tool such as a spatula to push down carefully at the hook positions and twist to pry the cover loose.



6.2 User Interface

Turn the unit on or off by pressing the On-Off Key. It will also turn off automatically after a about two minutes of non-use. Program operations can be selected using the cursor movement ring. Short-cut operations can be conducted using the Search, Zero and Span buttons to quickly connect to the VOXI and perform routine zero and span calibrations. The firmware is factory-set and cannot be changed by the user.

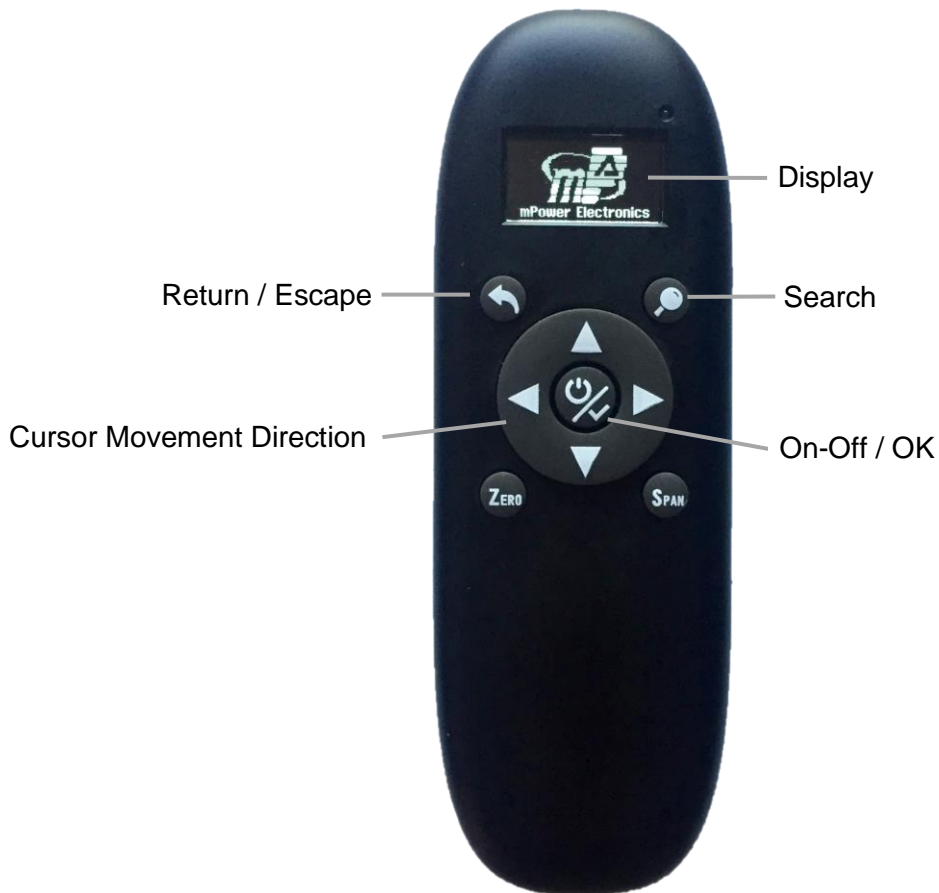



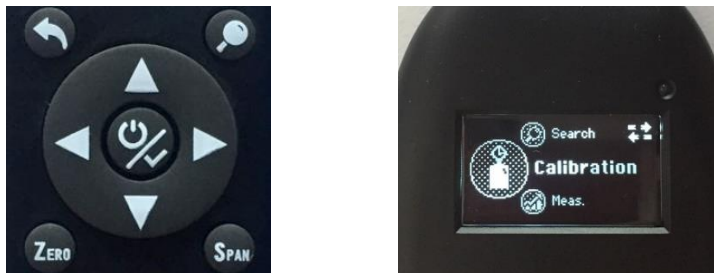

6.3 Menus and Sub-menus

Use the Up and Down arrows to scroll through the menu. Use the Right and Left arrows to enter or exit a menu item. When entering numerical values, use the left or right arrows to move the cursor, and the up and down arrows to increase or decrease the values, then press OK to save and exit. Turn the unit on or off by pressing the On-Off / OK button in the middle.



The table below lists all menus and their sub-menus.

				
Search	Calibration	Measurement	Alarm	Monitor Setup
Last Connect	Zero Calib	Meas. Unit	High Alarm	Address
Connect	Span Calib	Set Range	Low Alarm	Baud Rate
Locate	Set Span Value			Pump Stall Treshold
				4 mA Calibration
				20 mA Calibration
				Information

6.3.1 Search

- **Last Connect** immediately begins connection to the last instrument connected. This feature is convenient when only one unit is used and therefore searching is unnecessary.
- **Connect** searches for and presents a list of all available instruments. To connect, scroll to the desired monitor and push the right arrow or center OK button.
- **Locate** helps find the currently-communicating unit when multiple monitors are nearby. From this menu, press OK to cause the display to flash to identify the communicating unit.

6.3.2 Calibration

Perform zero and span calibrations the same way as described in the previous section for the mobile phone or tablet.

6.3.3 Measurement

- **Gas concentration units** can be set to **ppm** (parts per million), **ppb** (parts per billion), **mg/m³** (mg per cubic meter), **µg/m³** (µg per cubic meter), **µmol/mol** (micromole per mole), or **10⁻⁶** (1 millionth mole fraction).
- **Range** adjusts the maximum display value and sets the 20 mA analog output equivalent to that concentration value. The upper range can be set lower than the default range, but not higher. Note that reducing the range does not make the monitor any more sensitive, but simply allows over-range alarms to occur at a lower concentration.

6.3.4 Alarm

Set the numerical values for the low and high alarm limits.

6.3.5 Monitor Set-Up

- **Address** is used in the MODBUS messaging protocol.
- **Baud Rate** options are 4800, 9600 and 19200 bps and should be set to match that used in the MODBUS messaging protocol.
- **Pump Stall Threshold** allows manual adjustment of this parameter without doing a full pump block test (see previous section for full procedures)
- **4 mA Calibration** adjusts the raw counts to make a remote controller read 4 mA with zero gas applied.
- **20 mA Calibration** adjusts the raw counts to make a remote controller read 20 mA with gas applied at the full scale concentration.
- **Information** lists the instrument name, model, serial number and firmware version.

7. Maintenance

The VOXI requires regular filter replacement and possibly lamp & sensor cleaning if used in areas of high dust or condensation. The pump may also need service and the expected replacement period is about 2 years.

7.1 Replacing Filters

If the external filter is dirty or clogged, remove it by unscrewing it from the inlet. Discard it and replace it with a new water-trap filter. Dirty filters can be recognized by symptoms such as:

- Visible filter discoloration
- Visible moisture accumulation
- Frequent pump stalls

We recommend filter replacement at least every month for instruments that are used regularly, and more frequently, possibly daily, when used under very dusty or wet conditions.



IMPORTANT! The VOXI should not be operated without a filter. Operation without a filter may damage the instrument and shorten the life of the pump, sensor and PID lamp.

7.2 Removing/Cleaning/Replacing Lamp and Sensor

⚠ WARNING!

Replace lamp or sensor only in non-hazardous locations.

IMPORTANT! Always perform a full calibration after removing lamp or sensor.

7.2.1 Accessing PID Sensor and Lamp

Loosen the lock screw and remove the cover. Pinch the buckles on each side of the assembly, pull it out, and disconnect the wiring plugs. Remove the intake pipe (filter housing) from the main body. Push the PID sensor module in towards the main body and lift it up and out.



7.2.2 Lamp Cleaning and Changing

1. Remove the Sensor Cap and pull the sensor straight out, using a slight rocking motion if necessary.
2. Put on finger gloves and pull out the lamp. It may help to use fine tweezers; if so, do this very carefully so as not to damage the lamp. Insert a new lamp, or clean the existing lamp as described below.
3. Use a cotton swab wetted with methanol to clean the flat window surface of the lamp. If greasy dirt is hard to remove using methanol, the window can be polished using fine alumina powder polishing paste.
4. Use a clean tissue to wipe the lamp window again.
5. Re-insert the cleaned lamp, plug in the sensor and replace the sensor cap and VOXI cover.
6. Always re-calibrate the PID after cleaning the lamp and/or sensor.



7.2.3 Sensor Cleaning

1. Unscrew the sensor cover and pull the sensor straight out, using a slight rocking motion if necessary.



2. Put the sensor into a beaker and cover it with pure methanol or ethanol.



3. Put the beaker into an ultrasonic cleaning bath and sonicate for 15 minutes. Take out sensor and dry it, preferably using a gentle stream of clean air to blow the residual liquid out of the sensor.



4. Always re-calibrate the PID after cleaning the sensor.

7.3 Replacing Pump

For replacement of pump, please contact an authorized mPower service center.

8. Troubleshooting

Problem	Possible Reasons & Solutions
Readings abnormally High	<p>Reasons: Dirty filter(s). Dirty sensor module. Excessive moisture or water condensation. Incorrect calibration.</p> <p>Solutions: Replace filter(s). Clean or replace sensor module. Blow-dry the sensor module. Calibrate the unit.</p>
Readings abnormally Low	<p>Reasons: Dirty filter(s). Dirty sensor module. Weak or dirty lamp. Incorrect calibration.</p> <p>Solutions: Replace filter(s). Clean or replace sensor module. Clean or replace lamp. Calibrate the unit.</p>
Pump fail message Pump alarm	<p>Reasons: Inlet probe blocked. Direct connection to calibration gas outlet before the regulator is opened. External filter plugged with dirt or liquid. Water condensed in the internal gas distribution lines. Bad pump or pump circuit.</p> <p>Solutions: Remove the blocking materials and re-start power. Replace the contaminated filter(s). Be careful not to allow water condensation inside the unit. Replace or rebuild the pump (by Service Center).</p>
Cannot communicate with mobile device	<p>Reasons: Non-Android operating system. Android OS before 6.0 or recent background update</p> <p>Solutions: Use Android mobile device. Restore OS to that used before update (at least v 6.0)</p>
Lost password	<p>Solutions: Call Technical Support at (408) 320-1266</p>

For replacement parts please contact an authorized mPower Service Center.





8.1 4-20 mA Alarm Signals

To aid in troubleshooting, in addition to display text and LEDs, the 4-20 mA output identifies some alarms, as follows:

4-20 mA Signal	Condition
1 mA	Warming up
2 mA	Lamp failure
3 mA	Pump failure
22 mA	Over range

9. Technical Specifications

Detector Specifications

Size	8.4 x 7.1 x 5.0 in (213 x 180 x 127 mm)
Weight	3.3 lbs. (1.5 kg)
Sensor	Photo-ionization detector with standard 10.6 eV lamp
Detectable Chemicals	Volatile Organic Compounds (VOCs): fuels, solvents, paints, fumigants, ammonia, etc.
Calibration	Two-point calibration
Response Time	$t_{90} \leq 5$ seconds (for isobutylene)
Temperature	-40° to 158°F (-40° to 70°C)
Humidity	0% to 100% Relative humidity
Power	<5W; 12-30 VDC supply
Sampling Pump	Diaphragm pump ≥ 400 cc/min when responding chemicals are present. Pump duty cycling to ≥ 130 cc/min when PID response is below pre-set threshold. Sample from up to 100 ft (30 m).
Display	128x64 OLED: <ul style="list-style-type: none"> • Real-time readings (auto-ranging 4 digits) • Gas type • Measurement unit • Pump status • Bluetooth and wireless statuses if available
Communication	Remote controller and Android App
Outputs	<ul style="list-style-type: none"> • Analog: 4-20 mA (3 wires) • Digital: RS-485, • CAN or ModBus • 3 relays • 1 port to external strobe and horn
Alarms	OLED flashing, external strobe and horn
Event Log	Up to 10 alarm events
Housing	Aluminum alloy
Housing Entries	2 Conduit entries $\frac{3}{4}$ " NPT
IP Rating	IP-66
EMI/RFI	Highly resistant to EMI/RFI Compliant with EMC Directive 2014/30/EU
Safety Certifications	 Class I, Div. 1, Group ABCD T4 (pending) $-20^{\circ}\text{C} \leq T_{\text{amb}} \leq +50^{\circ}\text{C}$  Ex d ia IIC T4 Gb (pending)  II 2G Ex d ia IIC T4 Gb (pending)  European Conformity
Installation	Pipe holding, wall mount
Warranty	2 Years including PID sensor, 1 year on lamp

Model Options

Model	VOC Range (ppm)	Accuracy	Part No.
MP812	0.001-200	$\pm 2\%$ full scale	M008-0001-000
MP815	0.01-5,000	$\pm 5\%$ full scale	M008-0003-000
Options	<ul style="list-style-type: none"> • Intrinsically safe Android phone • Strobe and Horn • Calibration gas & regulator • Filter pack 		

Applications

- Fence-line & Environmental monitoring
- Air Quality control
- Oil, gas & refineries
- Chemical plants
- Manufacturing & processing
- Paints, coatings & adhesives
- Pharmaceuticals & food processing
- Solvent recovery
- Paper pulp and wastewater treatment
- Fumigation

All specifications are subject to change without notice. Please check for updates at www.mpowerinc.com.

Technical Support and mPower Contacts

mPower Electronics Inc.

3046 Scott Blvd. Santa Clara, CA 95054

Phone: (408) 320-1266

Fax: (669) 342-7077

info@mpowerinc.com

www.mpowerinc.com

