

GEN²

Model OI-7032

32-Channel

Operation Manual

Revision 2.5w



Product Overview

The Otis Instruments, Inc. GenII OI-7032 (32-Channel) is a Hybrid Monitor that supports up to 32 WireFree sensor units, and up to four 4-20mA input sensors (when only 28 channels are setup as WireFree).

The OI-7032 is backward compatible with GenI WireFree sensor units, and also supports GenII Wirefree sensor units (configurable).

For additional information regarding the OI-7032, see the Appendices at the end of this operation manual.



Table of Contents

Product Overview	2
Introduction	5
Warnings	6
Complete System Diagrams	7
<i>Front Panel</i>	7
<i>Internal Diagram</i>	8
<i>Terminal Board</i>	9
<i>Touchscreen (Front)</i>	10
<i>Touchscreen (Back)</i>	10
<i>AC (Delta) Power Supply</i>	11
<i>Internal Diagram – As Wired from the Factory</i>	12
<i>Internal Diagram – Completely Wired</i>	13
Wiring Configurations	14
<i>DC Power-in (24 Volts DC (nominal; 22-26 Volts DC))</i>	14
<i>AC Power Supply Connection</i>	17
<i>Touchscreen Power Connection</i>	19
<i>Touchscreen Connection</i>	22
<i>Memory Installation</i>	25
<i>Connecting Sensors</i>	27
Connecting Sensor 1.....	27
Connecting Sensor 2.....	29
Connecting Sensor 3.....	31
Connecting Sensor 4.....	33
<i>Relay Configurations</i>	35
Connecting Relay 1.....	35
Connecting Relay 2.....	37
Connecting Relay 3.....	39
Connecting Relay 4.....	41
Power On/Off	43
Basic Operation - Home Screen Navigation	44
<i>Trend Chart</i>	45
<i>Real-Time Values</i>	48
<i>Time Since Last Calibration and Null</i>	51
<i>Autoscroll On/Off</i>	53
<i>Channel Configuration</i>	54
Set as Wired or WireFree (Channels 29-32 ONLY).....	57
Processing.....	57
Relay Configuration.....	58
Setting Radio Address (WireFree).....	59
Setting Scale (Wired).....	60
Setting Sensor Location.....	61
Duplicate Settings	62
Channel Off	64
Configuration Menu Navigation	65
<i>Entering Configuration Menu</i>	66
<i>View Monitor Serial #</i>	67
<i>View Date Manufactured</i>	67
<i>Calibration Mode</i>	68
<i>Relay Tests</i>	69
<i>OI-7032 Restart</i>	70
<i>VIEW Modbus Output Settings: Address</i>	71

<i>VIEW Modbus Output Settings: Baud Rate</i>	71
<i>VIEW Radio Settings: Radio Timeout</i>	72
<i>VIEW Gen II Radio Settings: Network ID</i>	72
<i>VIEW Gen II Radio Settings: Primary or Secondary Monitor</i>	73
<i>VIEW OI-7032 Reset to Factory Default</i>	73
<i>VIEW Relay Settings: Relays 1-4 (Failsafe)</i>	74
<i>VIEW Relay Settings: Fault Terminal</i>	74
<i>VIEW Relay Settings: Fault Relay Assign</i>	75
Configuration Menu Modifications (Second-Level Configuration Menu)	76
<i>MODIFY Modbus Output Settings: Address</i>	77
<i>MODIFY Modbus Output Settings: Baud Rate</i>	78
<i>MODIFY Radio Settings: Radio Timeout</i>	78
<i>MODIFY Gen II Radio Settings: Network ID</i>	79
<i>MODIFY Gen II Radio Settings: Primary or Secondary Monitor</i>	79
<i>MODIFY OI-7032 Reset to Factory Default</i>	80
<i>MODIFY Relay Settings: Relays 1-4 (Failsafe)</i>	80
<i>MODIFY Relay Settings: Fault Terminal</i>	81
<i>MODIFY Relay Settings: Fault Relay Assign</i>	81
Relay Indicator	82
Fault Indicator	83
<i>Fault Status</i>	83
Channel On Without Wired Sensor Connected (Fault).....	84
F1: Check Sensor Cable.....	84
F4: Check Sensor Board.....	85
Error Messages	86
<i>Double-Primary Error</i>	86
<i>Autoscroll Error</i>	87
APPENDIX A: Software Installation	88
Installation	89
<i>HMI Software</i>	89
APPENDIX B: Reading USB Drive	93
USB Drive	94
<i>Removing the USB Drive</i>	94
<i>Reading the USB Drive</i>	94
Opening the Datalog Files.....	94
Opening the Easy Converter Software.....	94
Converting the Datalog File to an .xls (spreadsheet) File.....	97
Viewing the Datalog File.....	97
When Finished Reading the USB Drive.....	97
APPENDIX C: 4-20mA Loop Current Introduction	98
<i>4-20mA Current Loop Introduction</i>	99
<i>Overview</i>	99
<i>Calculations</i>	99
<i>Measuring Current</i>	100
Specifications	101

Introduction

This document is an Operation Manual containing diagrams and step-by-step instruction for proper operation of the Otis Instruments, Inc. GenII OI-7032. This document should be read before initial operation of the product.

Should a question arise during the use of the product, this document will serve as a first reference for consultation. If further questions arise, or if the device is not working properly, please contact the sales representative of this product.

Warnings

- The OI-7032 should only be used in an environment that constantly remains between the range of -20 to 122 degrees Fahrenheit. If the OI-7032 is at risk of being exposed to temperatures that are outside the previously stated range, DO NOT install the device in that location. For applications in areas with the potential of reaching extreme temperatures, Otis Instruments recommends using the OI-7032 indoors only (in a temperature-controlled environment).
- Even when the Power switch is in the off position, the AC and DC terminals are still hot—regardless of if the device is wired as DC.
- Wiring Configuration Warnings:
 - Provide a clean and stable 24 Volts DC (nominal; 22-26 Volts DC) voltage. Failure to do so may cause the unit (and any wired sensors that are connected to the unit) to not operate properly.
 - Voltage spikes higher than 26 Volts may damage the unit.
 - Solar Panel power (with battery backup): This options may be used to power the unit, however, care must be taken to ensure the proper voltage and wattage is used.

NOTE: The size that the solar panel should be (10, 30, 50, or 100 watts, for example) depends on several factors, including: geographical area, line-of-sight access to the sun, number of wired sensors connected, and weather conditions.

Please consult a solar panel manufacturer for specific details. Otis Instruments, Inc. may also be contacted to provide guidance and recommendations.

Complete System Diagrams

The following diagrams should be consulted for identification of Panels, Boards, and any other system component that may be referred to in this Operation Manual.

Front Panel



Internal Diagram



Terminal Board

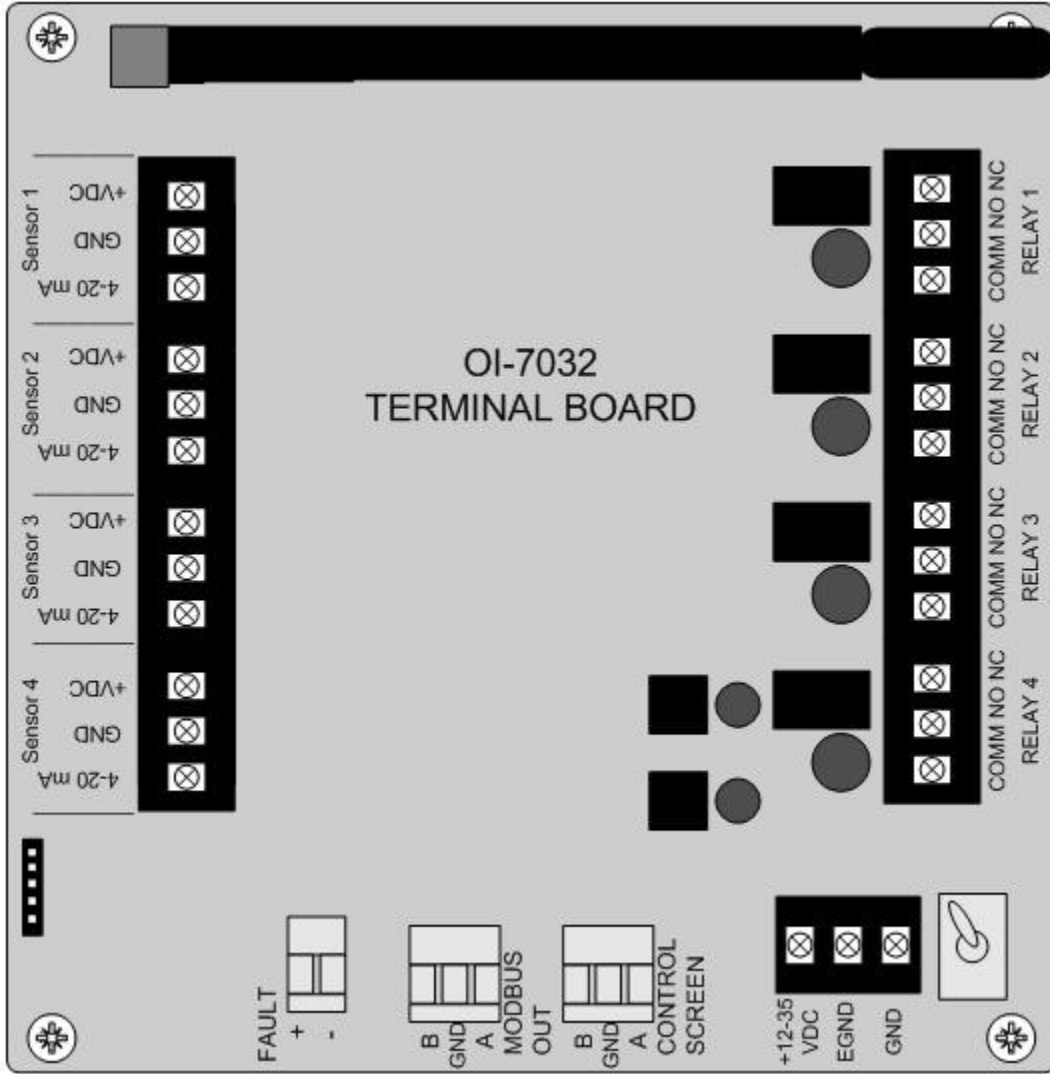

Touchscreen (Front)



Touchscreen (Back)



AC (Delta) Power Supply

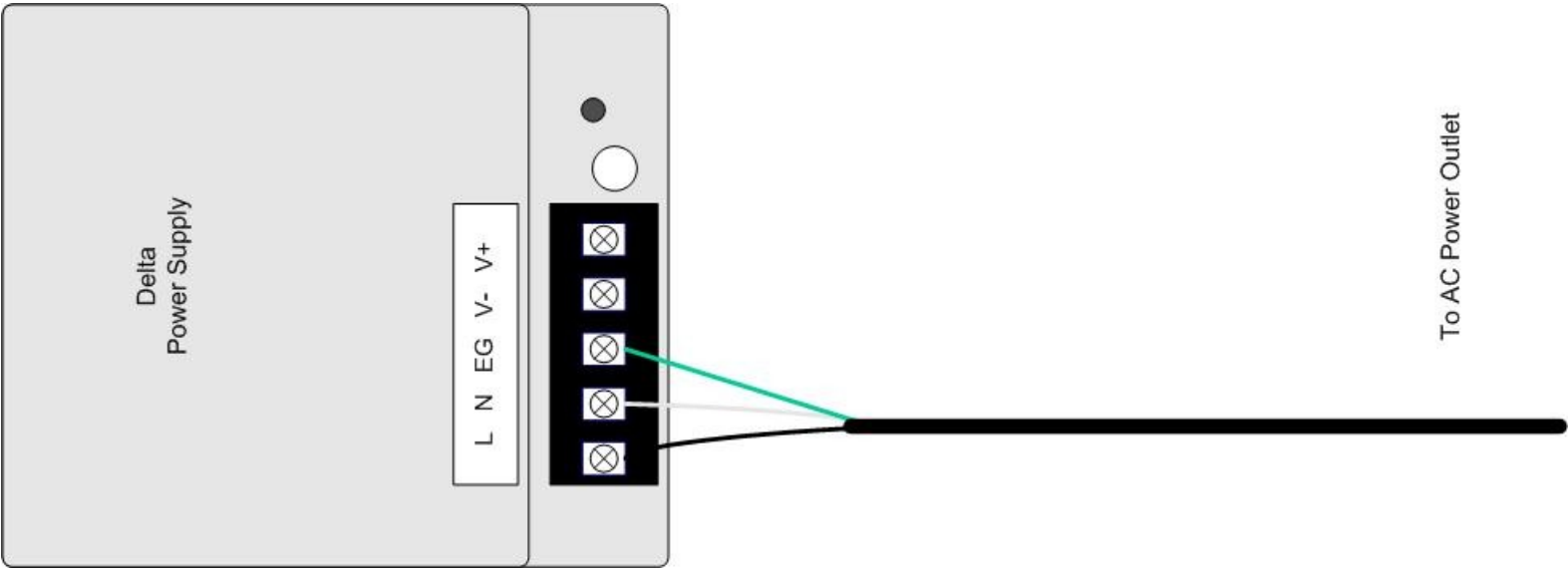

Internal Diagram – As Wired from the Factory

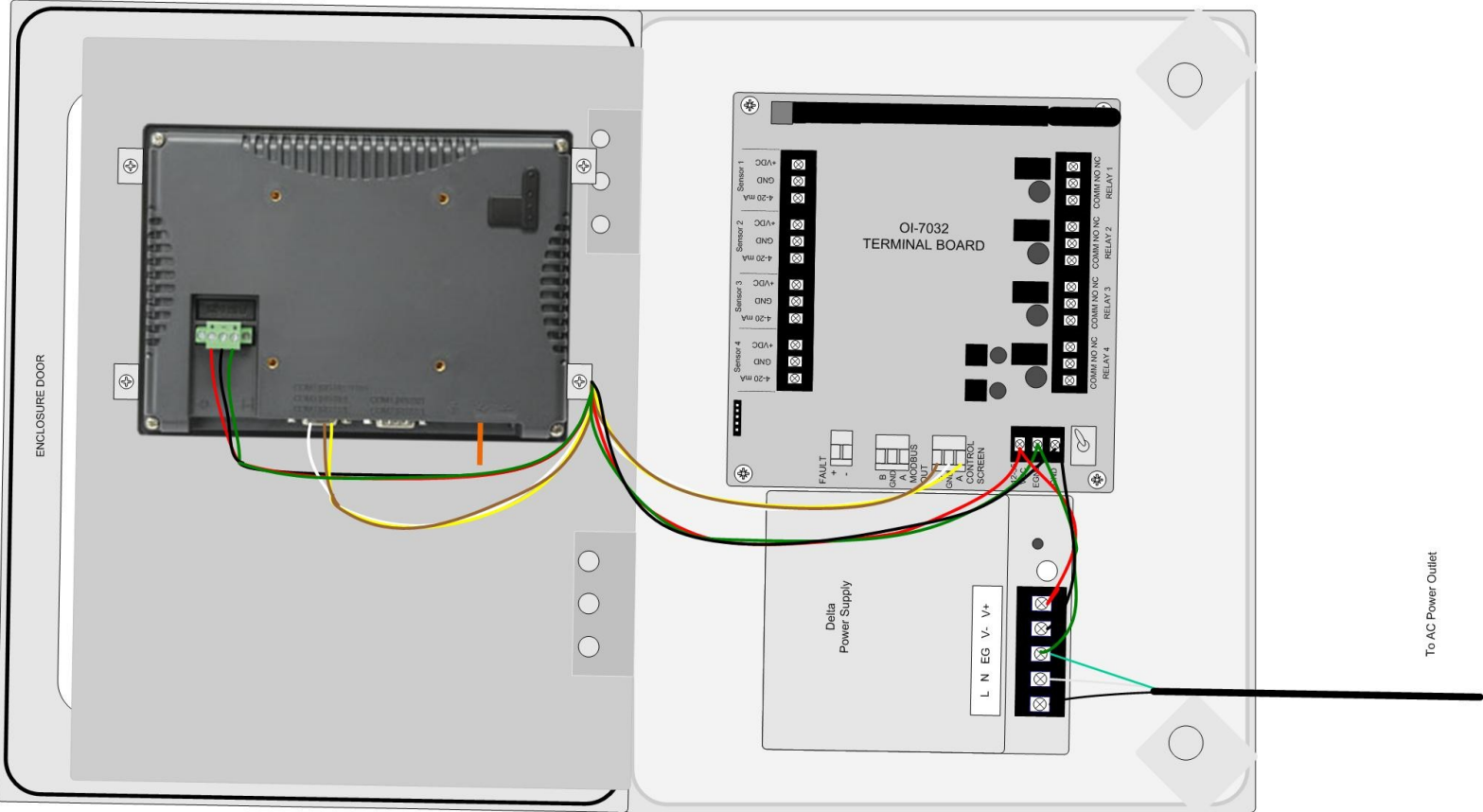

Internal Diagram – Completely Wired

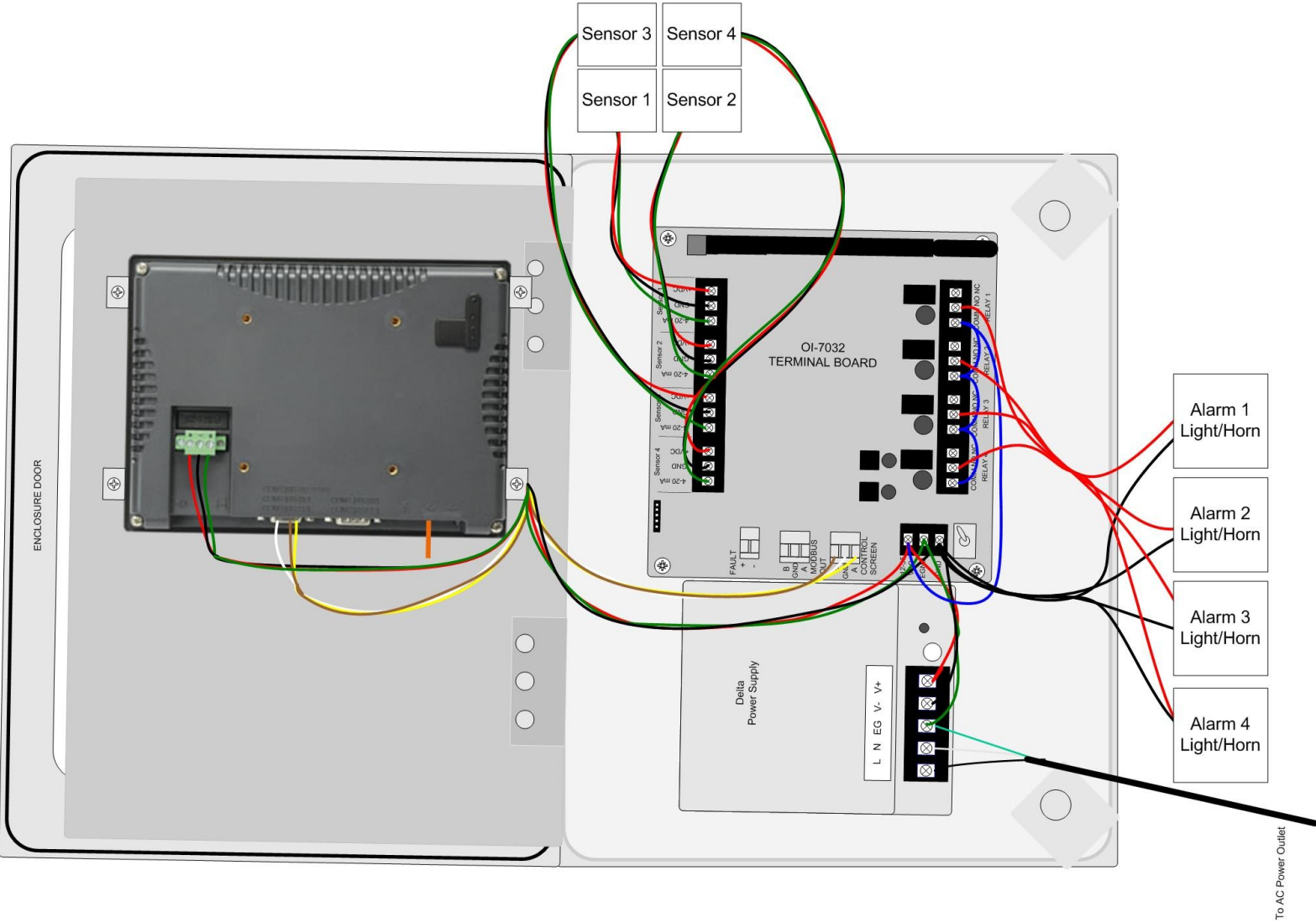

Wiring Configurations

The following Wiring Configurations must be completed before initial operation of the product.

DC Power-in (24 Volts DC (nominal; 22-26 Volts DC))

NOTE: The unit will be wired for the power-type that is requested by the purchaser when shipped from Otis Instruments, Inc.

When wiring the device, the following should be considered:

- Provide a clean and stable 24 Volts DC (nominal; 22-26 Volts DC) voltage. Failure to do so may cause the unit (and any wired sensors that are connected to the unit) to not operate properly.
- Voltage spikes higher than 26 Volts may damage the unit.
- Solar Panel power (with battery backup): This options may be used to power the unit, however, care must be taken to ensure the proper voltage and wattage is used.

NOTE: The size that the solar panel should be (10, 30, 50, or 100 watts, for example) depends on several factors, including: geographical area, line-of-sight access to the sun, number of wired sensors connected, and weather conditions.

Please consult a solar panel manufacture for specific details. Otis Instruments, Inc. may also be contacted to provide guidance and recommendations.

DC Power-in (24 Volts DC (nominal; 22-26 Volts DC)) cont...

1. Open the enclosure box to expose the Front Panel.
2. Unscrew the two thumb-screws on the Front Panel.
3. Open the Front Panel so that the Terminal Board is exposed.

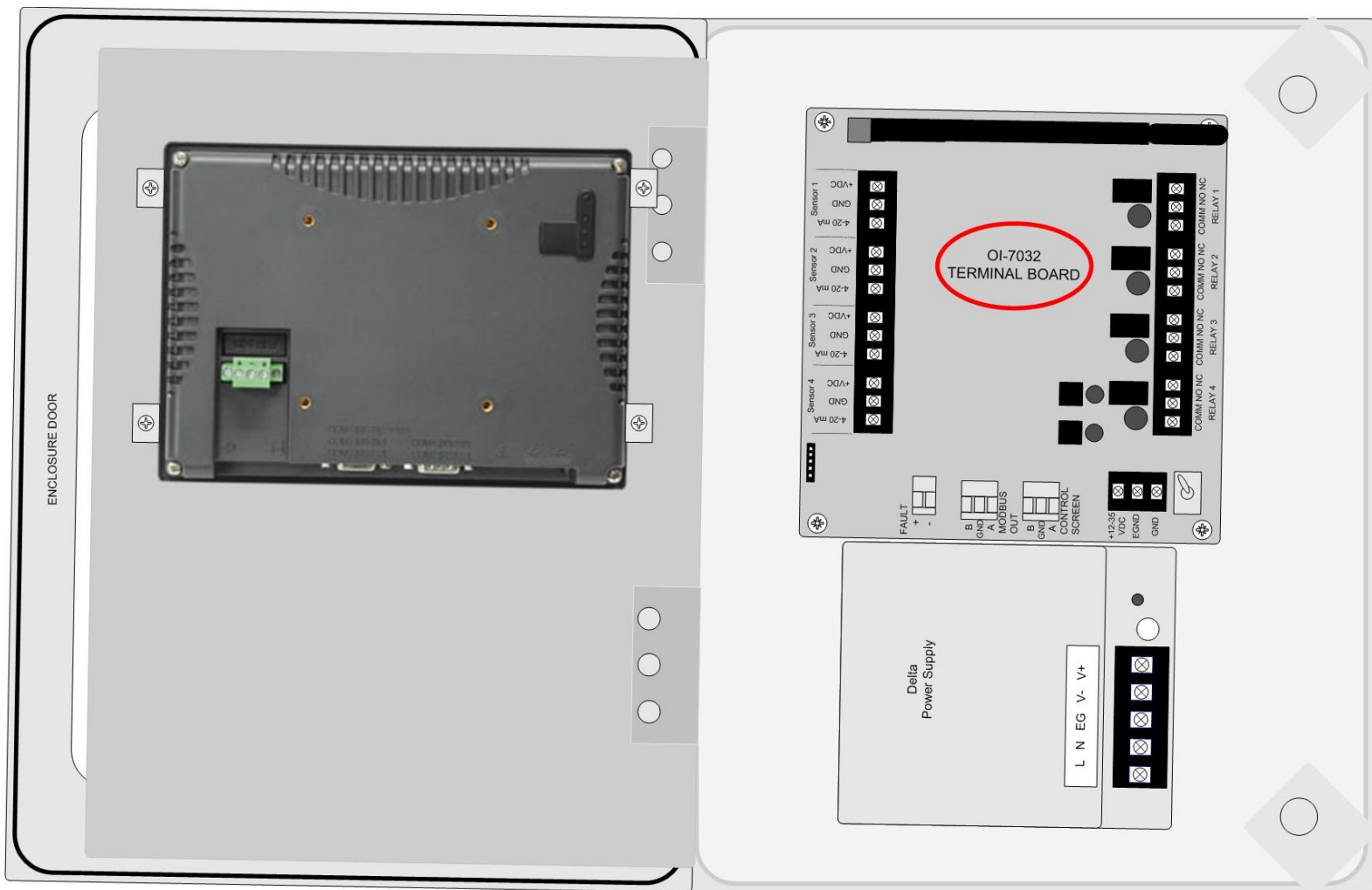

4. Locate the Power Terminal (on the lower right side of the Terminal Board).
5. Connect the DC Power Supply live wire (red) to the terminal marked “+12-35 VDC”.

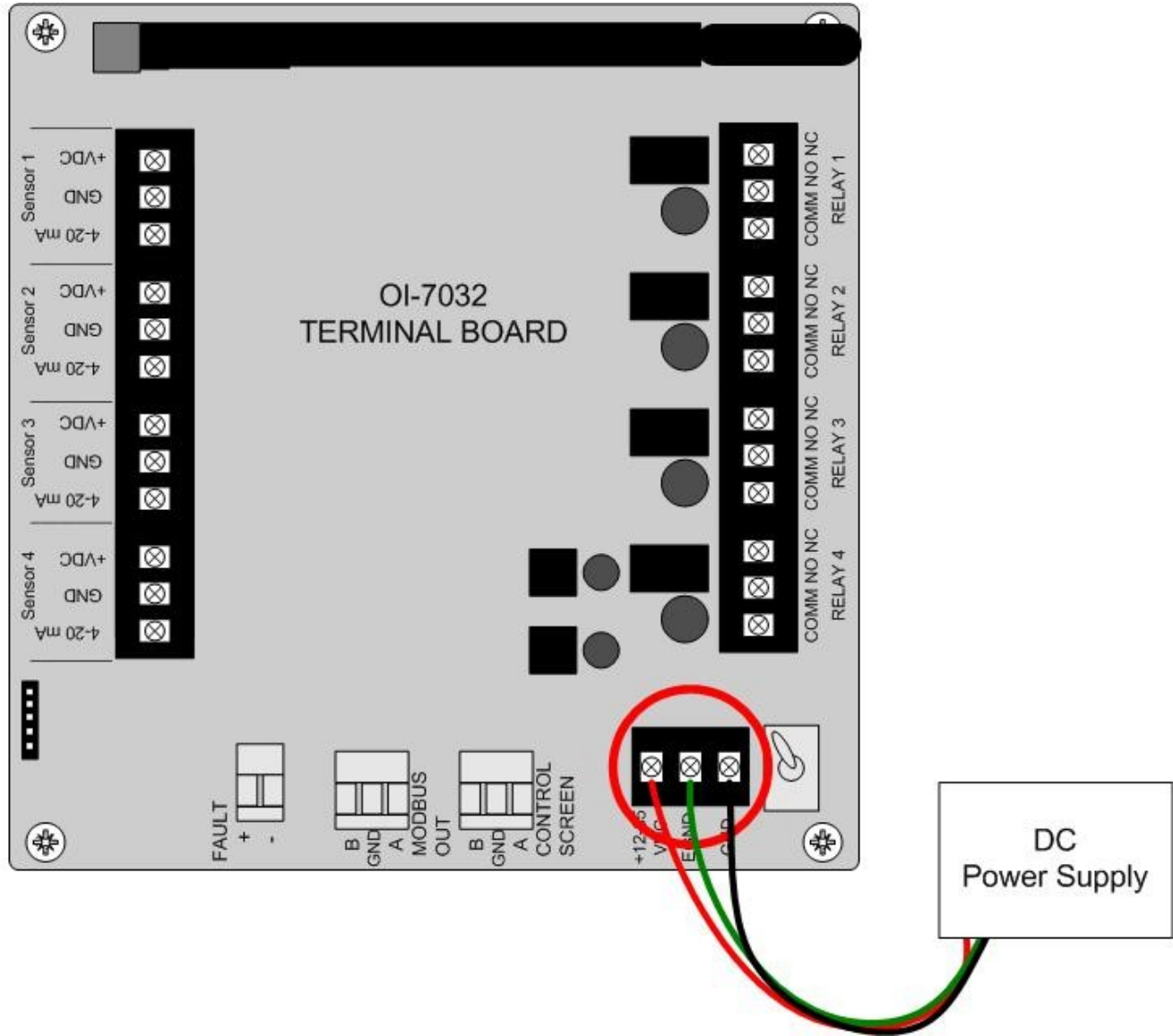

6. Connect the DC Power Supply Ground wire (black) to the terminal marked “GND”.
7. If desired, connect an Earth Ground wire (green) to the terminal marked “EGND” (required for surge suppression).
8. Close the Front Panel.
9. Screw in the thumb-screws.
10. Close the enclosure box.

AC Power Supply Connection

For AC Power applications, the Delta Power Supply located below the Terminal Board should be used.

NOTE: The unit will be wired for the power-type that is requested by the purchaser when shipped from Otis Instruments, Inc.

- 1. Open the enclosure box to expose the Front Panel.
- 2. Unscrew the two thumb-screws on the Front Panel.
- 3. Open the Front Panel so that the AC (Delta) Power Supply is exposed.

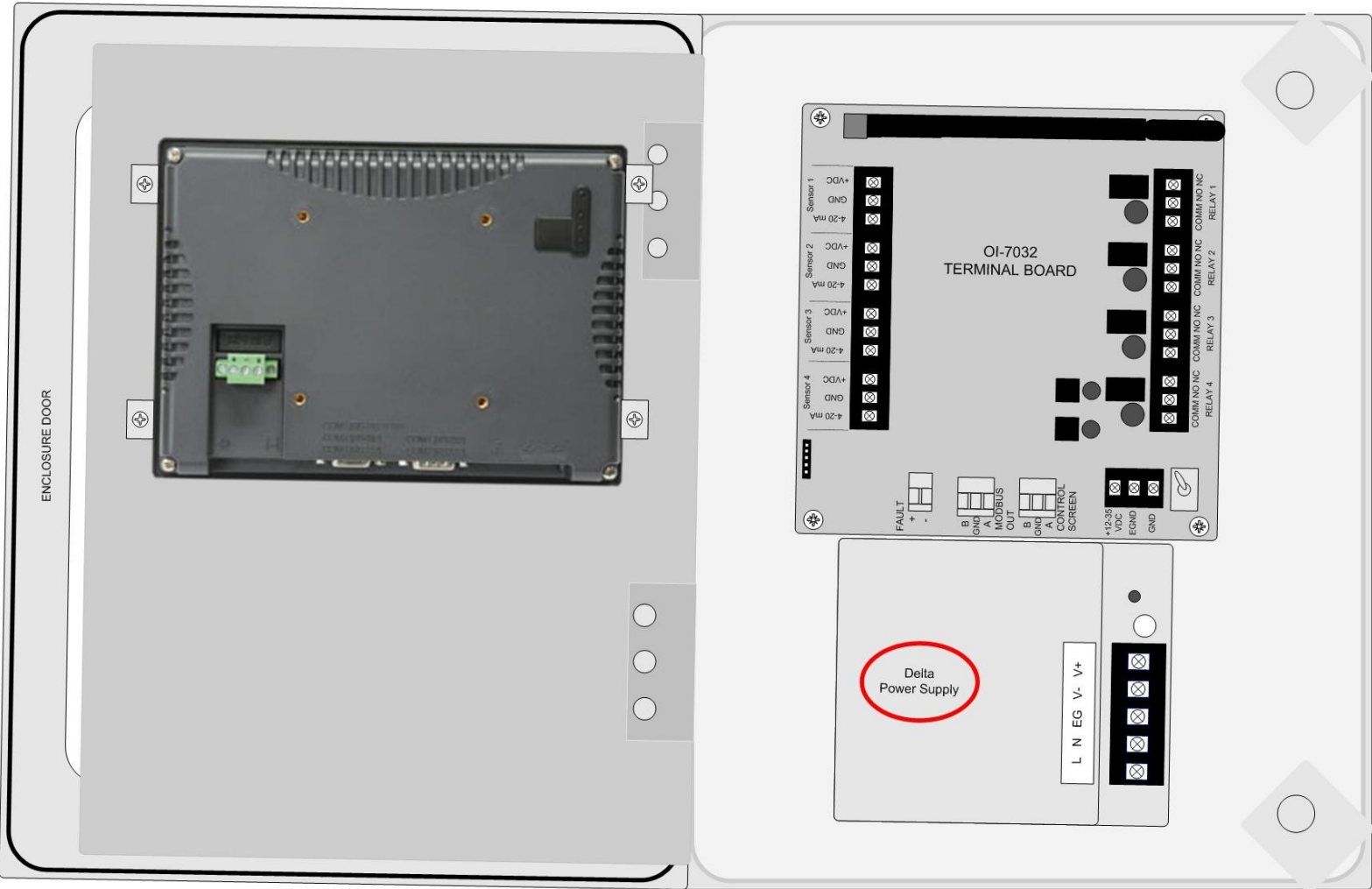

4. Connect a positive (red) wire to the Power Terminal terminal labeled “+12-35 VDC” on the Terminal Board.
5. Connect the other end of that same positive (red) wire from the Terminal Board to the terminal labeled “+V” on the Delta power supply.
6. Connect a negative (black) wire from the Power Terminal terminal labeled “GND” on the Terminal Board.
7. Connect the other end of that same negative (black) wire from the Terminal Board to the terminal labeled “-V” on the Delta power supply.
8. There will be three wires (black, white and green) pre-wired from the Delta power supply terminals “L” (AC Load IN), “N” (AC Neutral IN), and “EG” (Chassis GND or Earth GND). This set of wires will be used to plug into an AC power outlet ONCE ALL WIRING CONFIGURATIONS ARE COMPLETE.



9. Close the Front Panel.
10. Screw in the thumb-screws.
11. Close the enclosure box.

Touchscreen Power Connection

NOTE: The Touchscreen power connection will be pre-wired for use when the unit is shipped from Otis Instruments, Inc.

1. Open the enclosure box to expose the Front Panel.
2. Unscrew the two thumb-screws on the Front Panel.
3. Open the Front Panel so that the back of the Touchscreen is exposed.

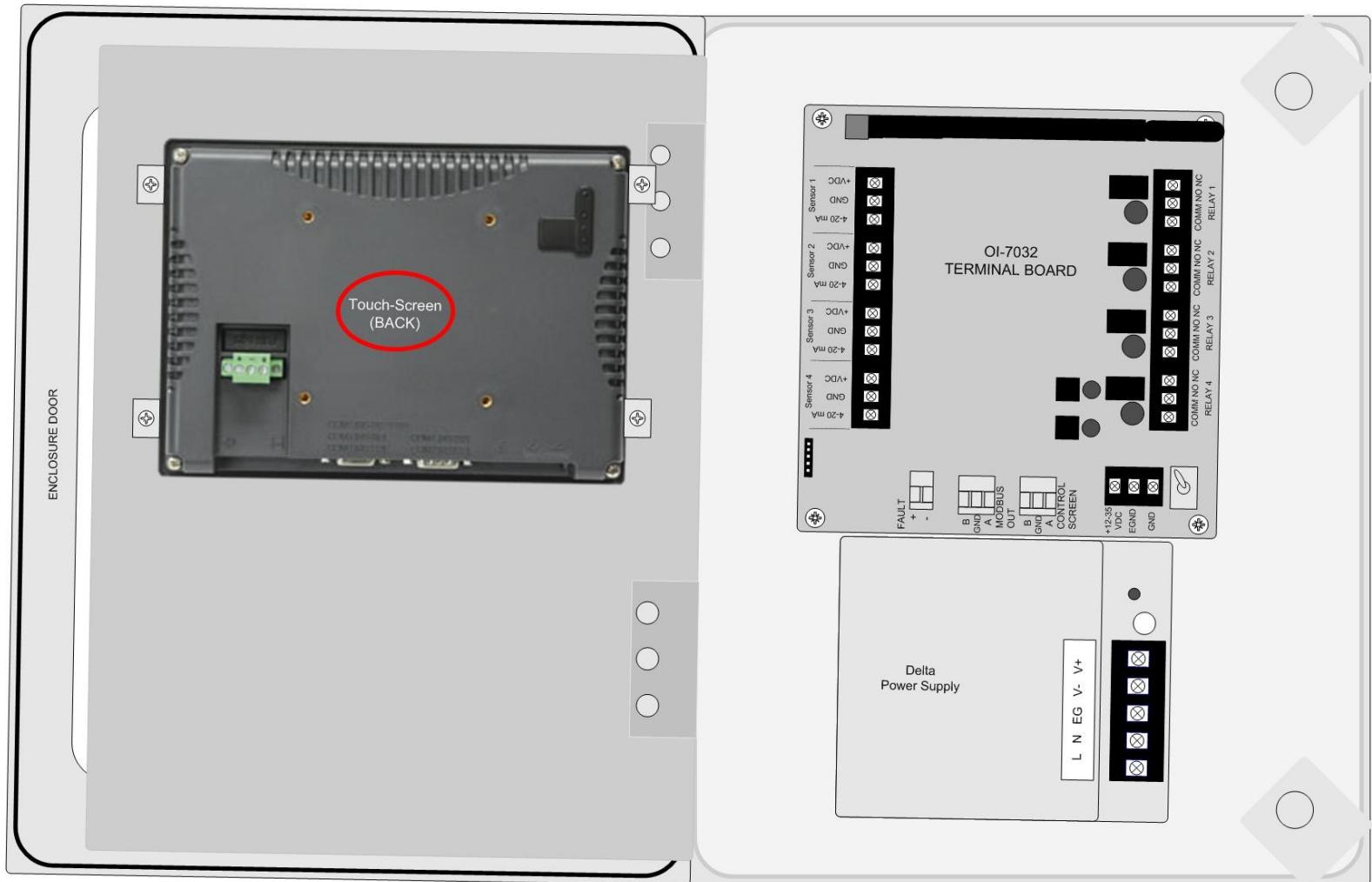

4. Locate the Touchscreen's Power Terminal.
5. Connect the positive DC Supply wire (red) to the terminal labeled “+”.
6. Connect the negative DC Supply wire (black) to the terminal labeled “-”.
7. Connect an earth ground wire (green) to the ground terminal.

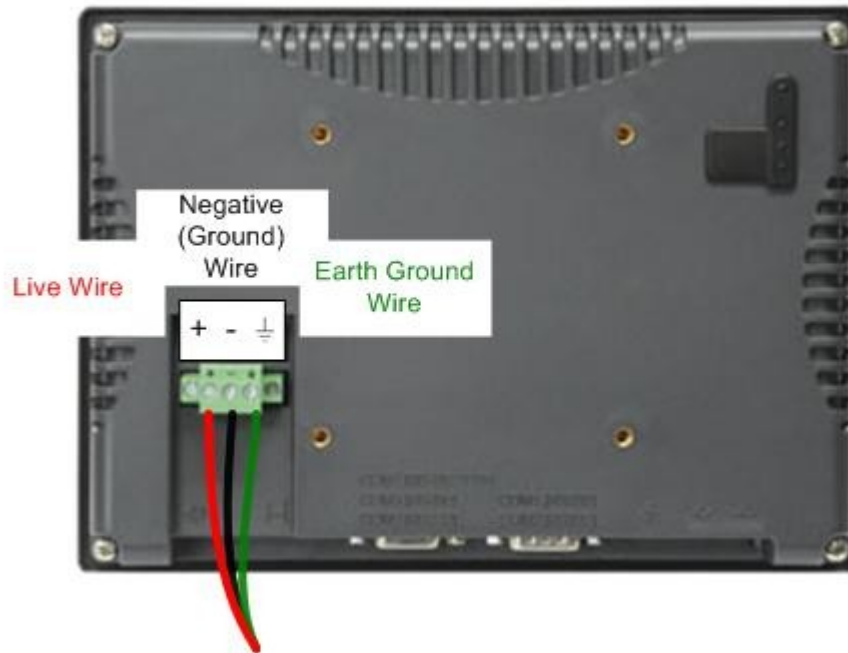

8. Locate the Power Supply Terminal Block on the Terminal Board.

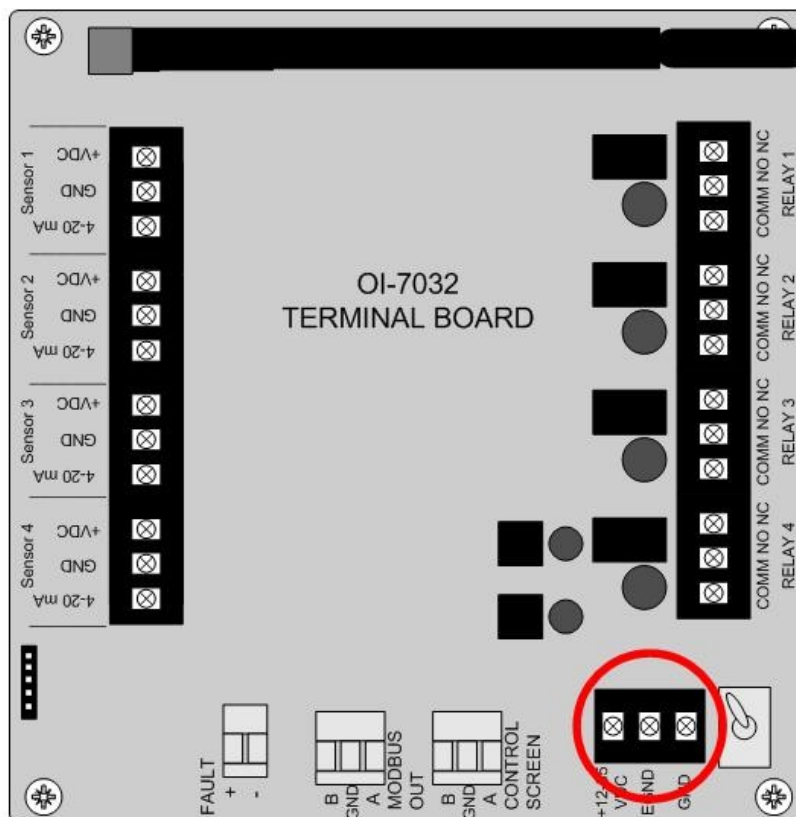

9. Connect the positive DC Supply wire (red) to the terminal labeled “12-32 VDC” on the Power Supply Terminal Block.
10. Connect the negative DC Supply wire (black) to the terminal labeled “GND” on the Power Supply Terminal Block.
11. Connect the earth ground wire (green) to the terminal labeled “EGND” on the Power Supply Terminal Block.

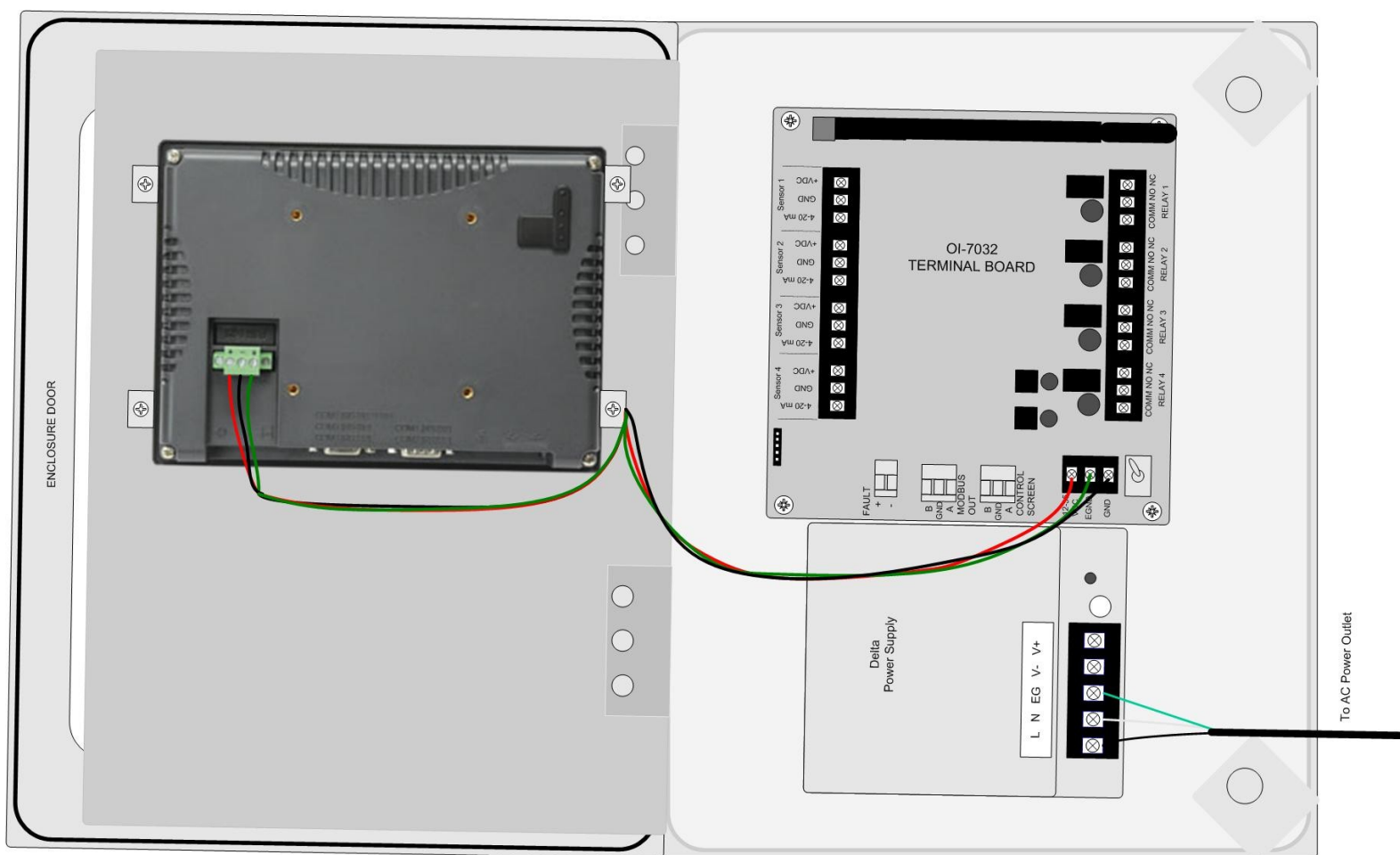

12. Close the Front Panel.
13. Screw in the thumb-screws.
14. Close the enclosure box.

Touchscreen Connection

NOTE: The OI-7032 Touchscreen will be pre-wired when the unit is shipped from Otis Instruments, Inc.

1. Open the enclosure box to expose the Front Panel.
2. Unscrew the two thumb-screws on the Front Panel.
3. Open the Front Panel so that the back of the Touchscreen is exposed.

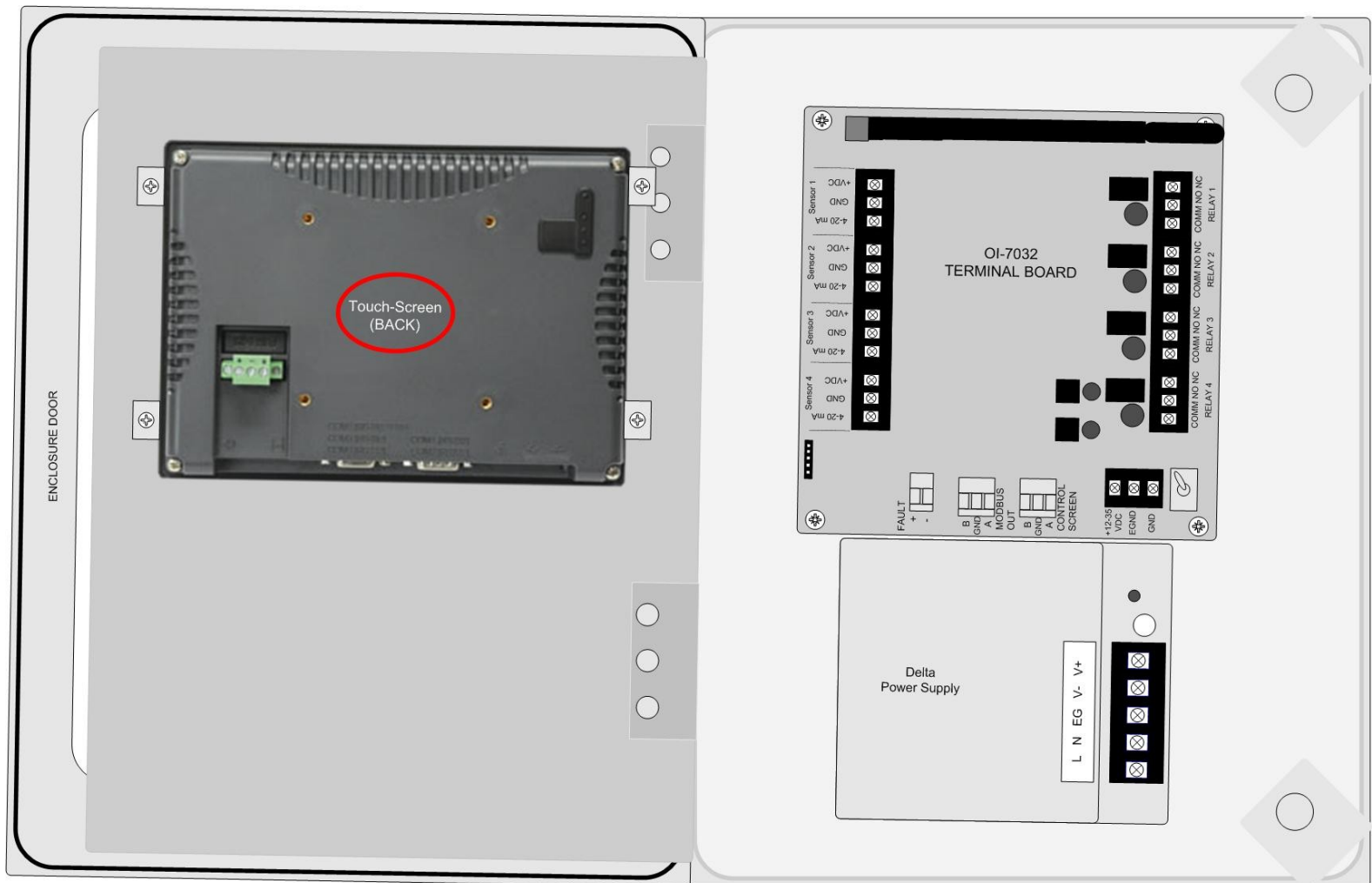

4. Locate the COM Port and the Control Screen Terminal Block.

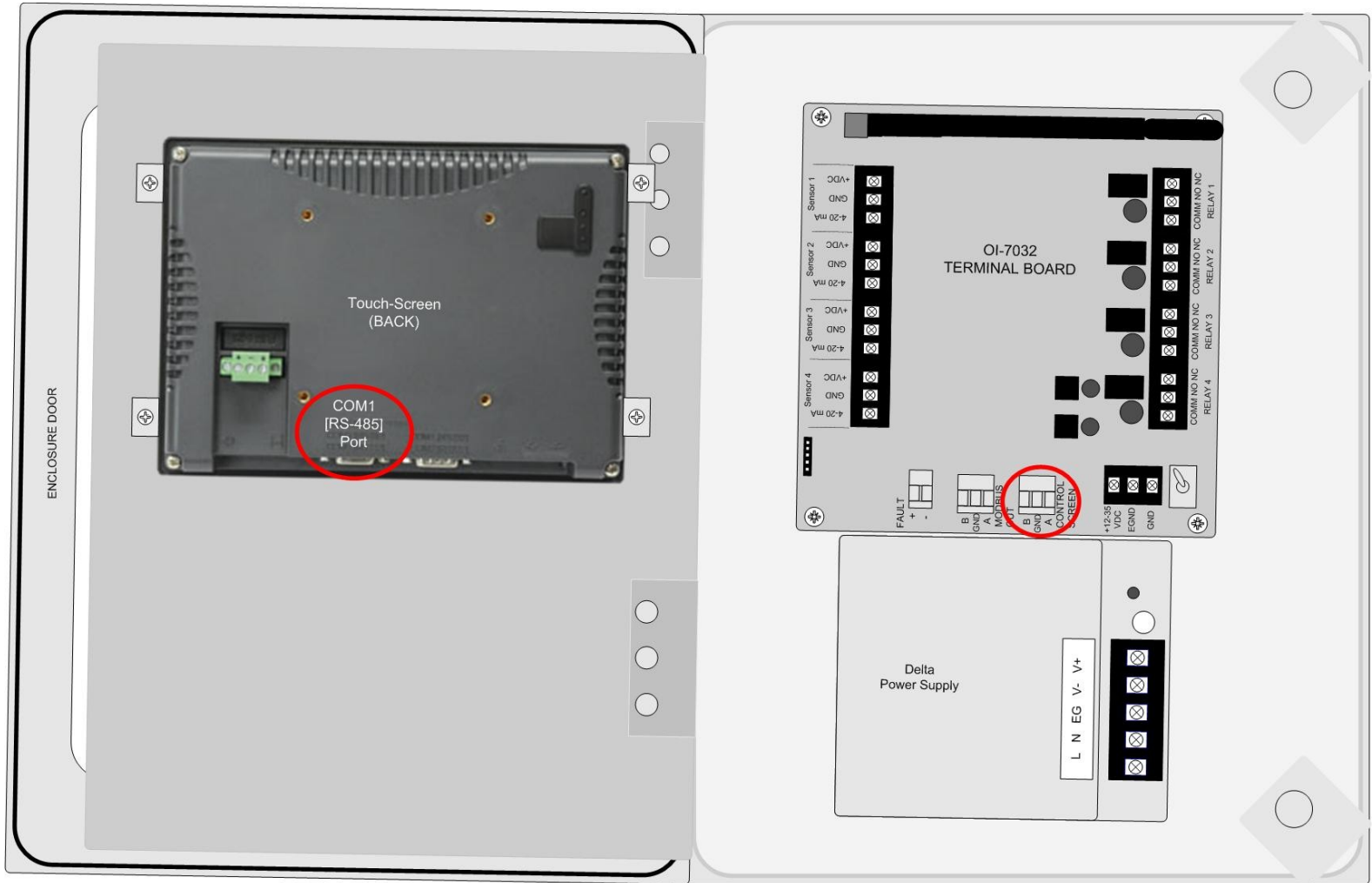

5. Plug the DB-9 connector into the COM1 Port.

6. Connect the yellow wire from the DB-9 connector to the terminal labeled “A” on the Control Screen Terminal Block.
7. Connect the white wire from the DB-9 connector to the terminal labeled “GND” on the Control Screen Terminal Block.
8. Connect the brown wire from the DB-9 connector to the terminal labeled “B” on the Control Screen Terminal Block.

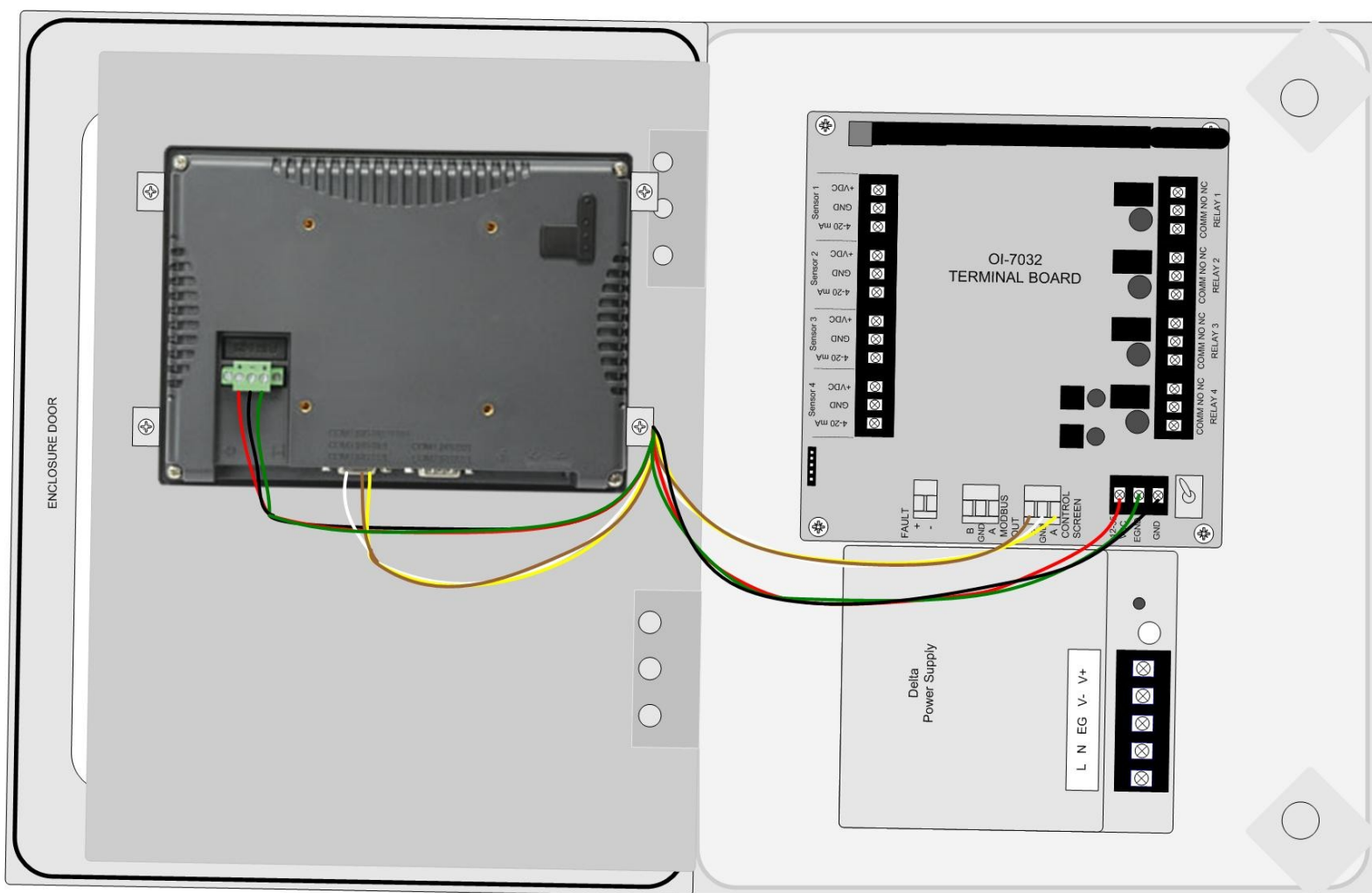

9. Close the Front Panel.
10. Screw in the thumb-screws.
11. Close the enclosure box.

Memory Installation

NOTE: The maximum memory card capacity is 2GB.

NOTE: The OI-7032 memory card will be pre-installed in the touch-screen when the unit is shipped from Otis Instruments, Inc.

- 1. Open the enclosure box to expose the Front Panel.
- 2. Unscrew the two thumb-screws on the Front Panel.
- 3. Open the Front Panel so that the back of the Touchscreen is exposed.

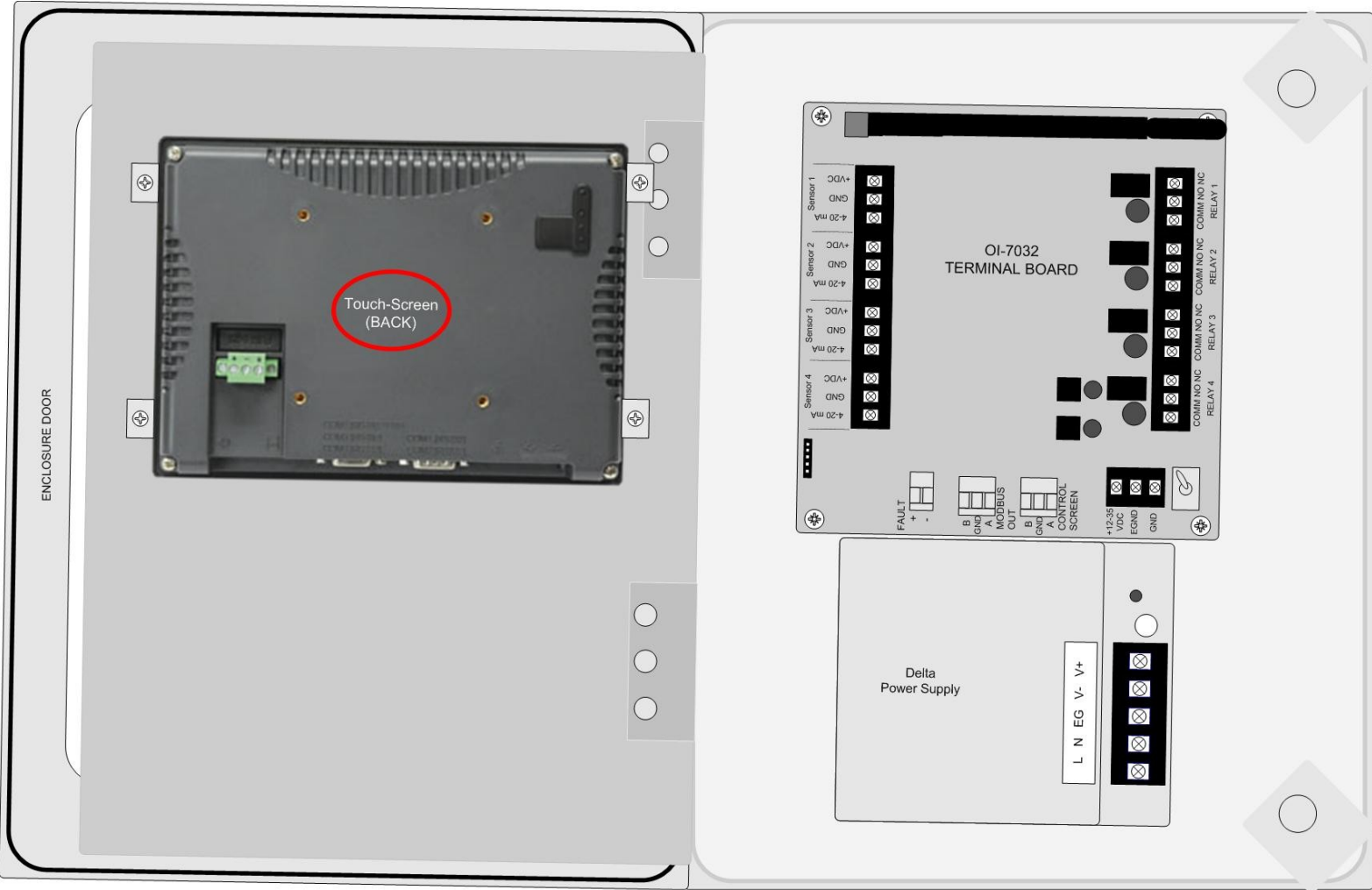

4. Locate the USB Port on the back of the Touchscreen.



5. Insert a USB-compatible memory card into the USB Port.

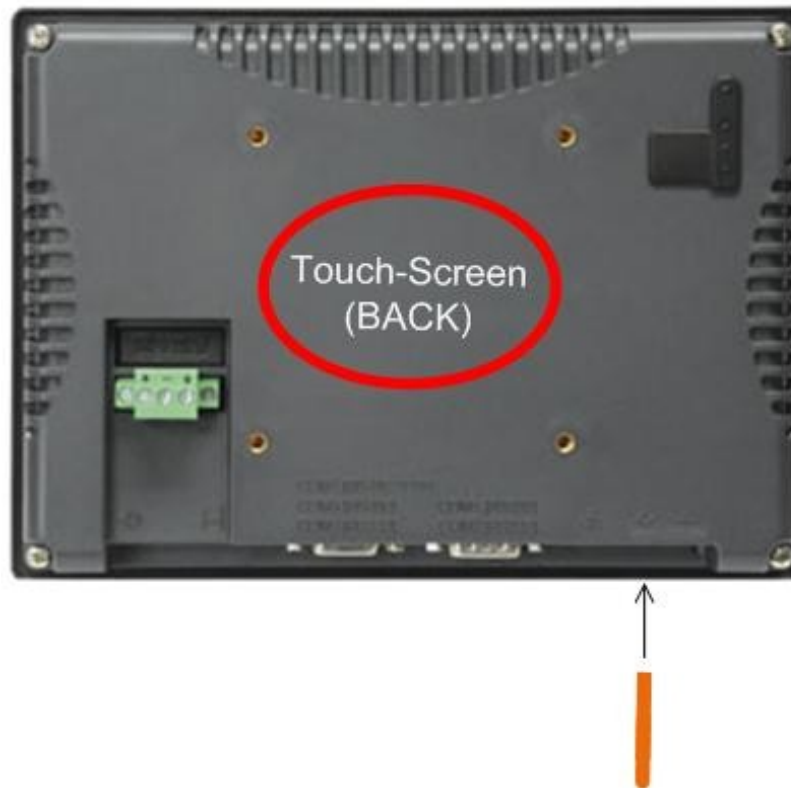

6. Close the Front Panel.
7. Screw in the thumb-screws.
8. Close the enclosure box.

Connecting Sensors

The OI-7032 is capable of monitoring up to four wired (4-20mA) sensors. Sensor connection should be completed according to the following instructions.

Connecting Sensor 1

1. Locate the Sensor 1 Terminal Block on the Terminal Board.

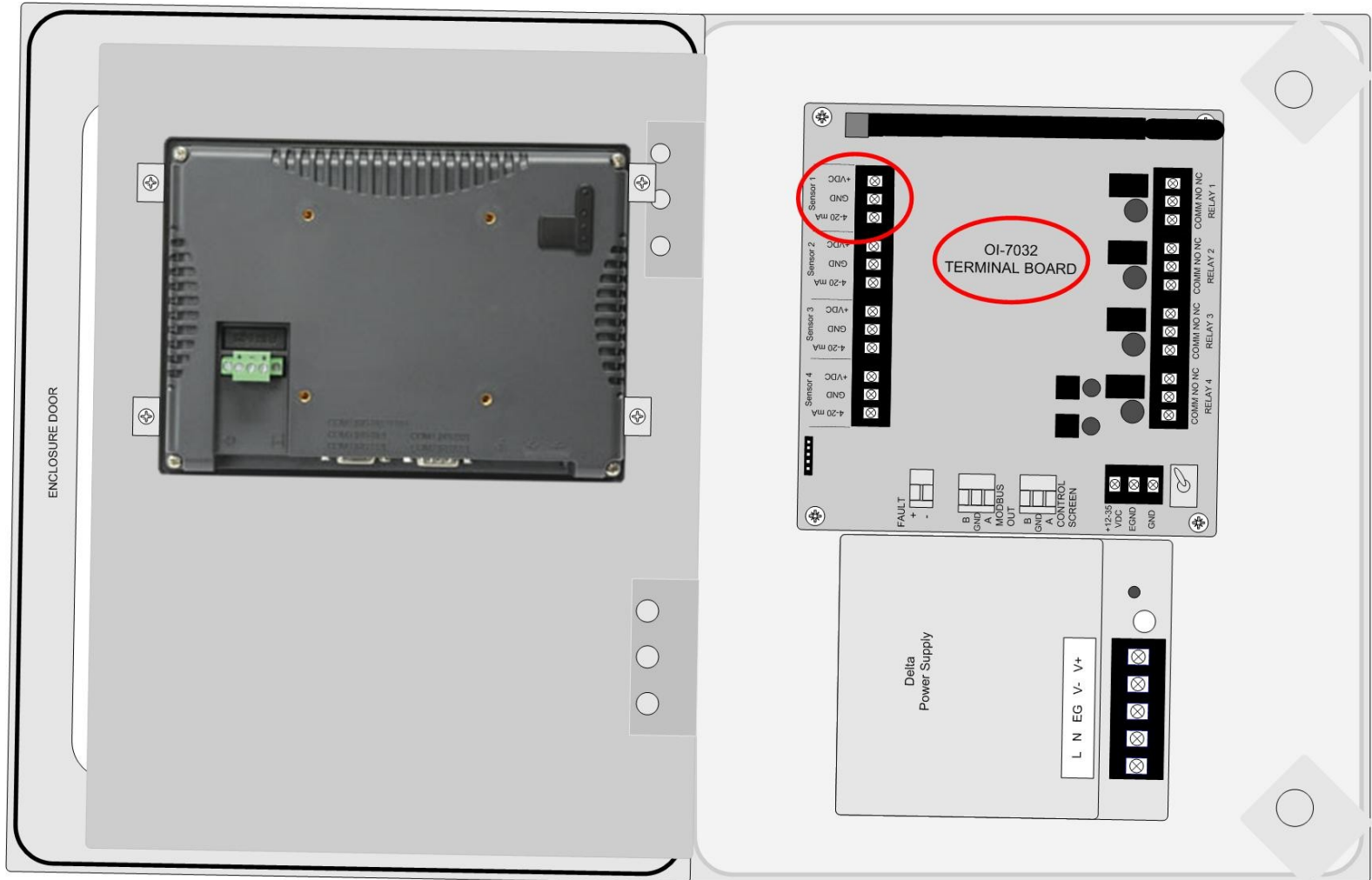

Connecting Sensor 1 cont...

- 2. Connect the positive (red) wire to the terminal labeled “+VDC”.
- 3. Connect the signal (green) wire to the terminal labeled “4-20mA”.
- 4. Connect the neutral (black) wire to the terminal labeled “GND”.

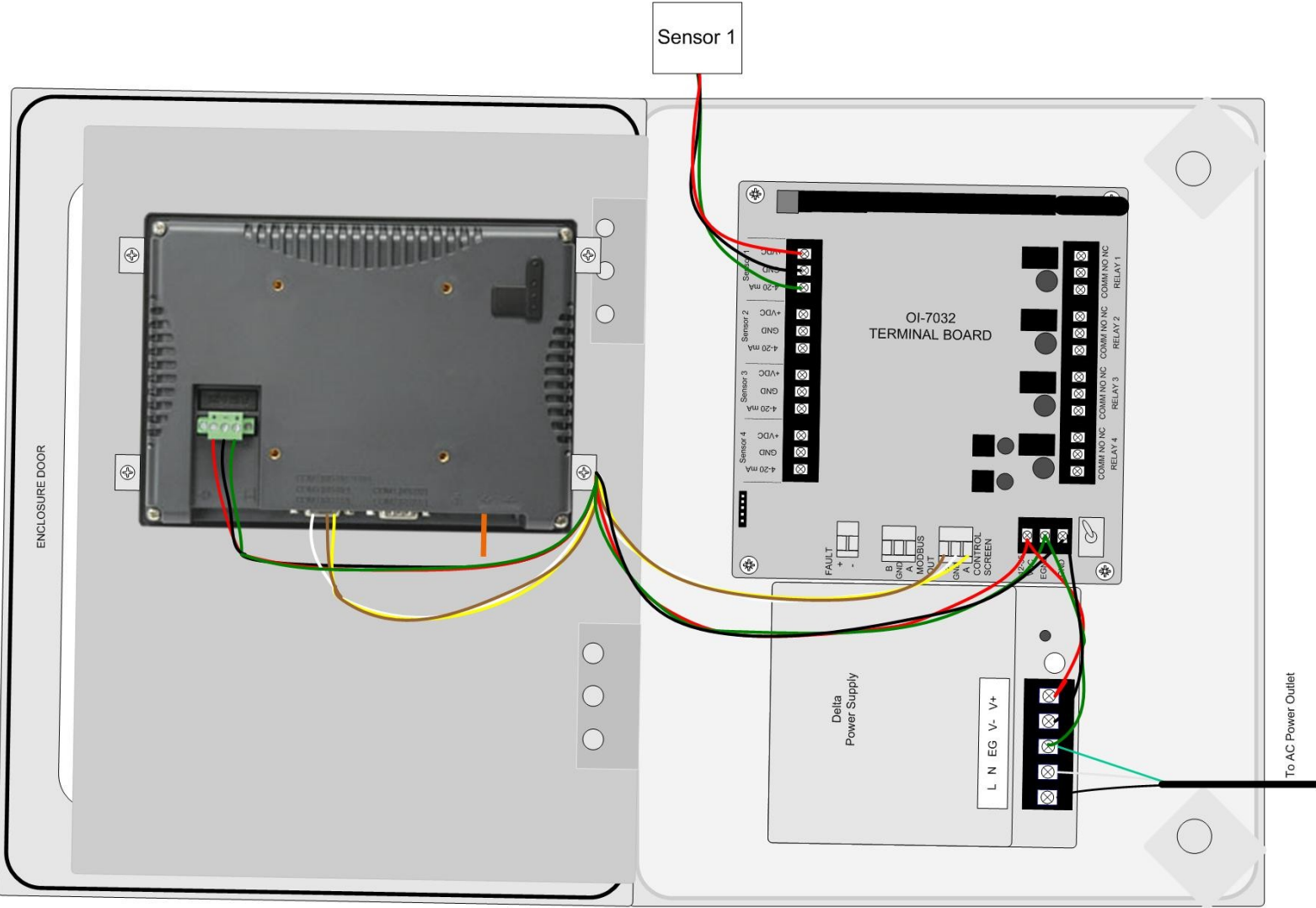

Connecting Sensor 2

- 1. Locate the Sensor 2 Terminal Block on the Terminal Board.

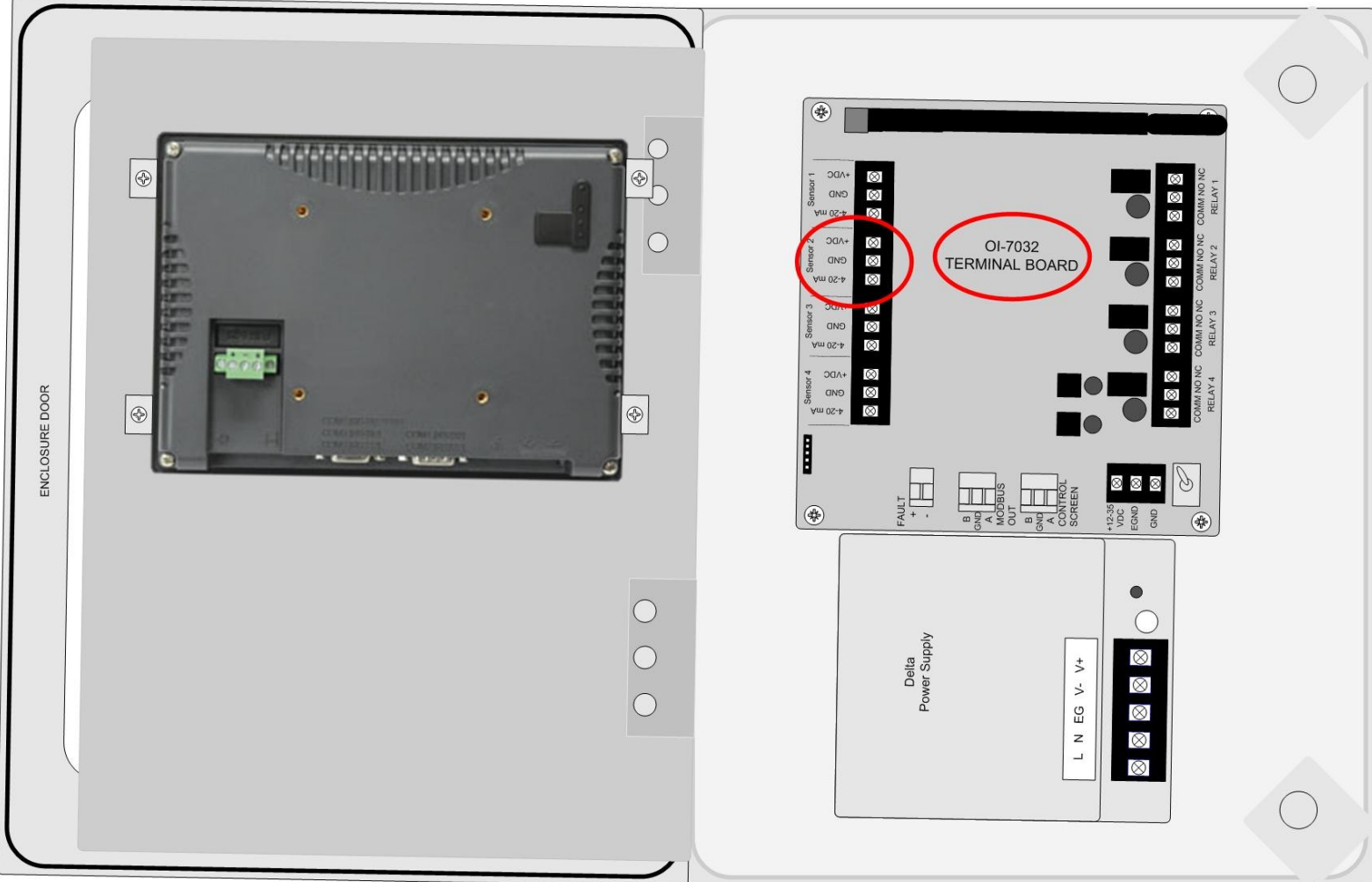

Connecting Sensor 2 cont...

- 2. Connect the positive (red) wire to the terminal labeled “+VDC”.
- 3. Connect the signal (green) wire to the terminal labeled “4-20mA”.
- 4. Connect the neutral (black) wire to the terminal labeled “GND”.

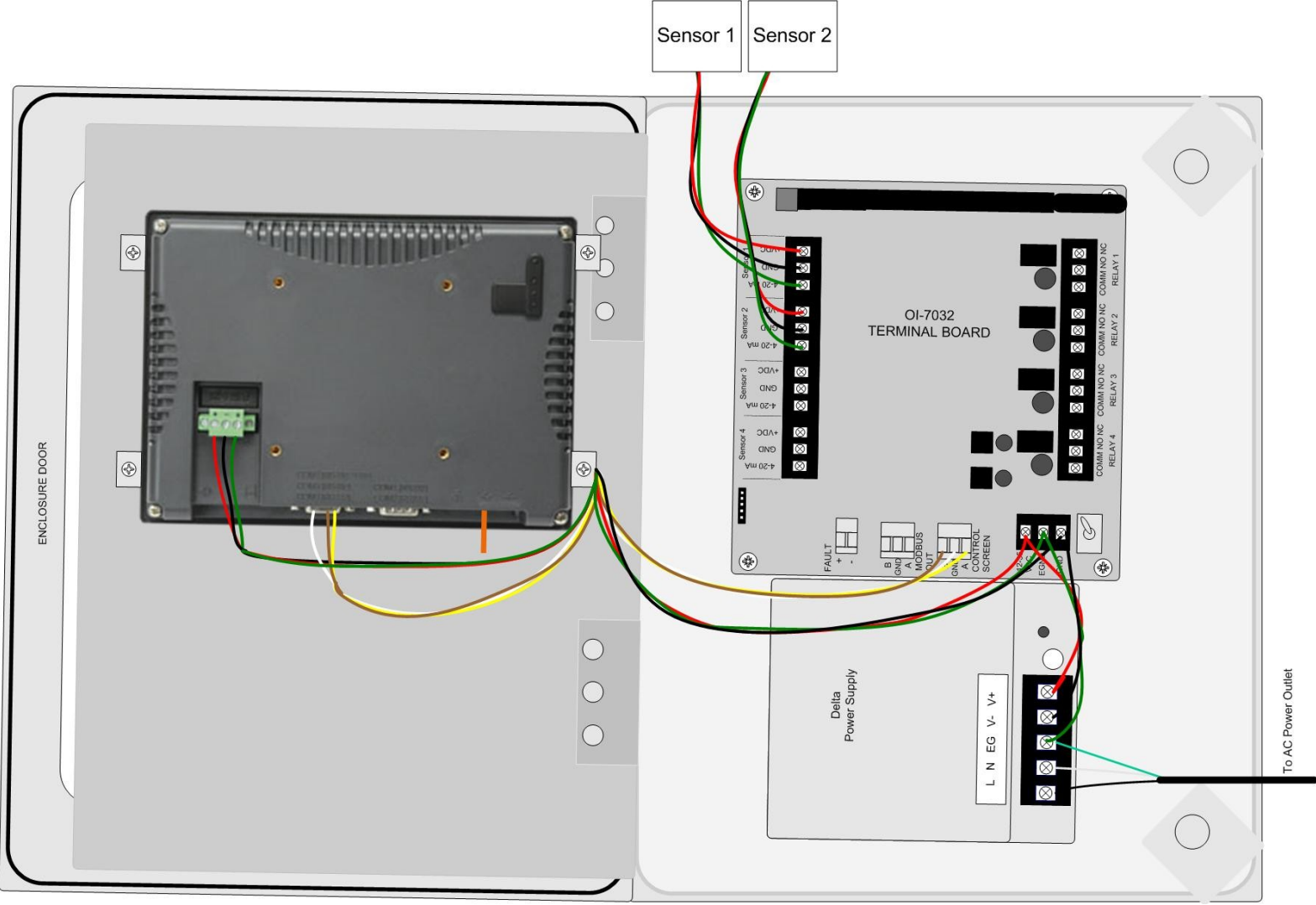

Connecting Sensor 3

- 1. Locate the Sensor 3 Terminal Block on the Terminal Board.

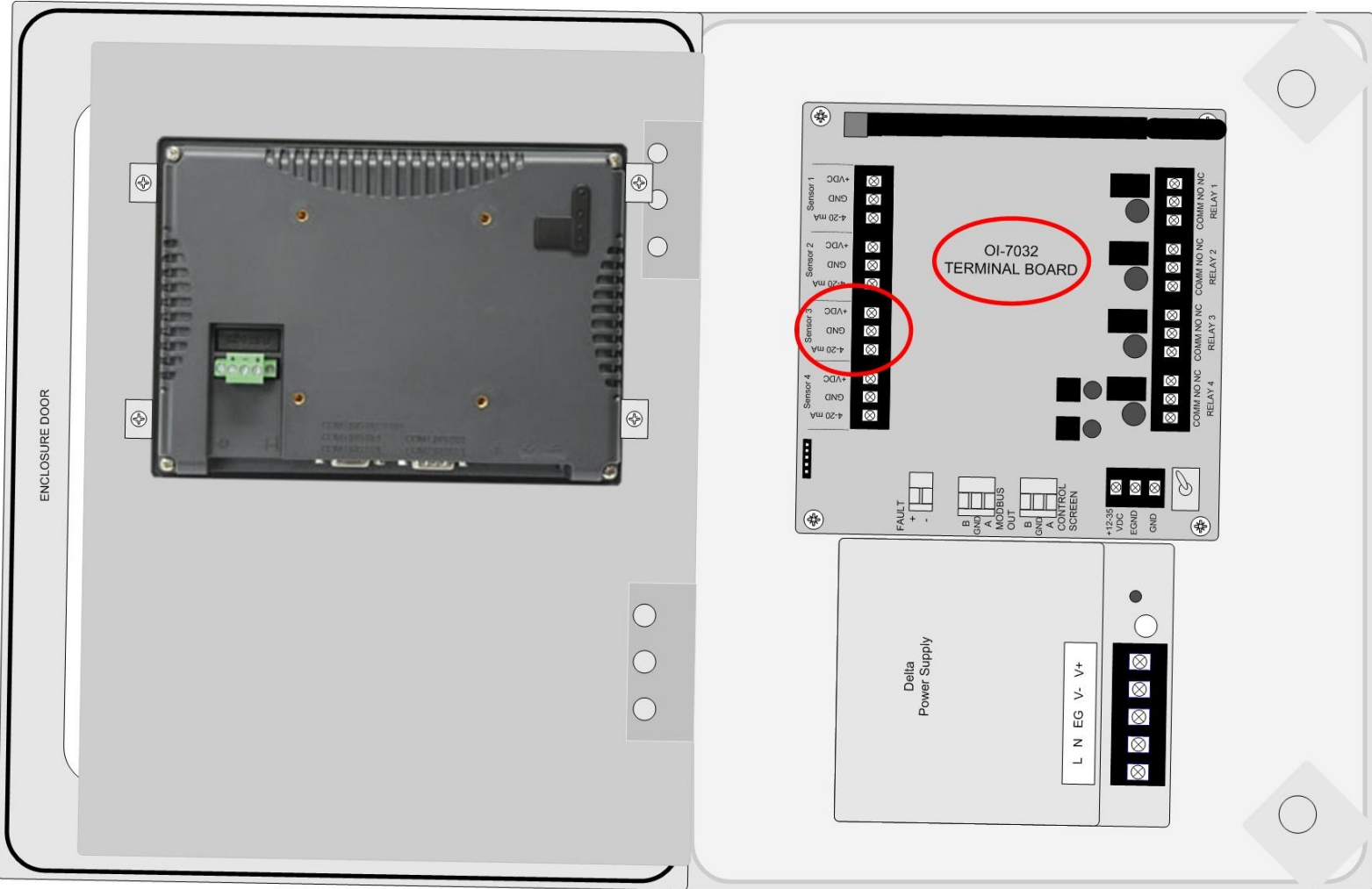

Connecting Sensor 3 cont...

- 2. Connect the positive (red) wire to the terminal labeled “+VDC”.
- 3. Connect the signal (green) wire to the terminal labeled “4-20mA”.
- 4. Connect the neutral (black) wire to the terminal labeled “GND”.

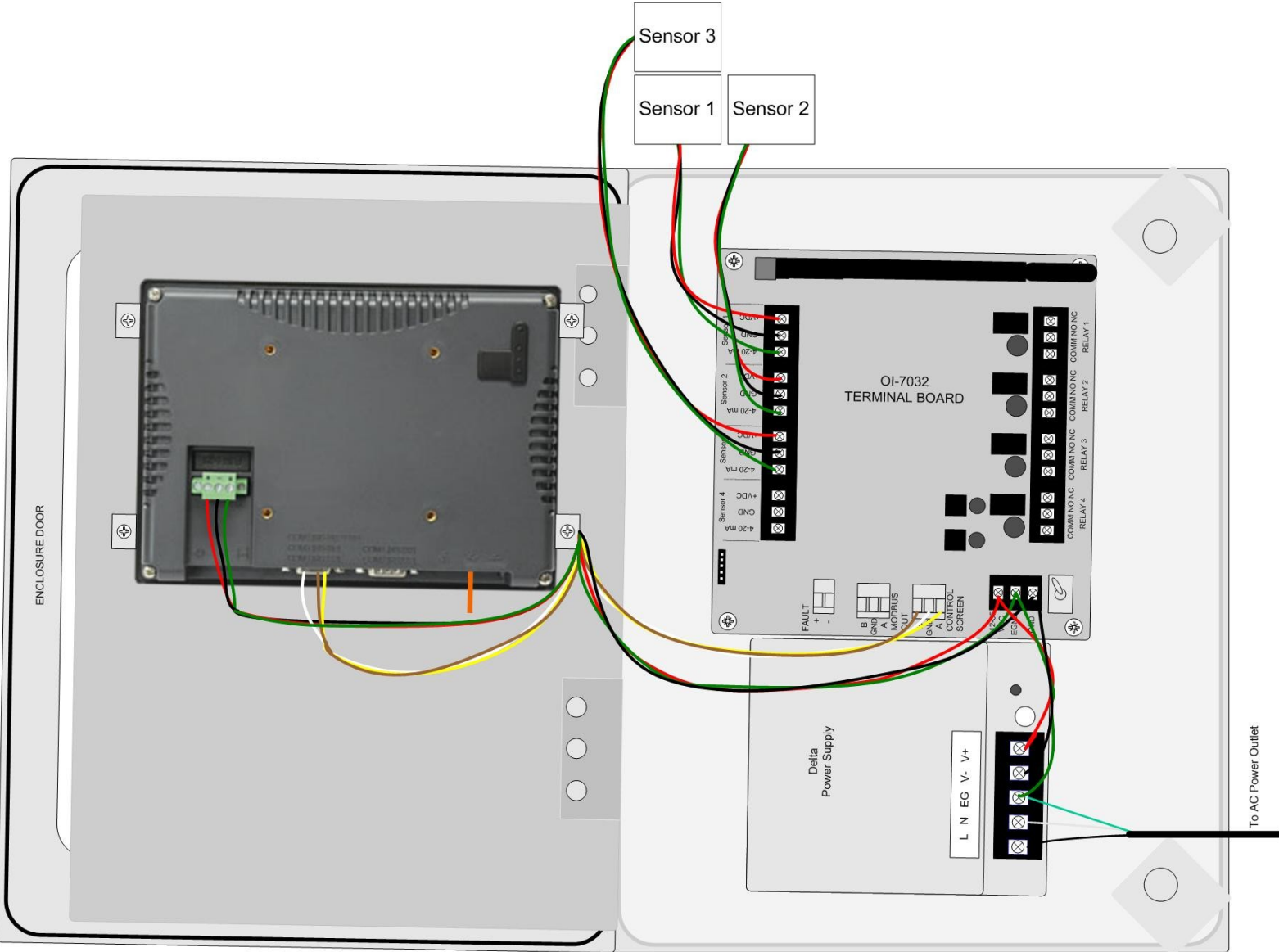

Connecting Sensor 4

- 1. Locate the Sensor 4 Terminal Block on the Terminal Board.

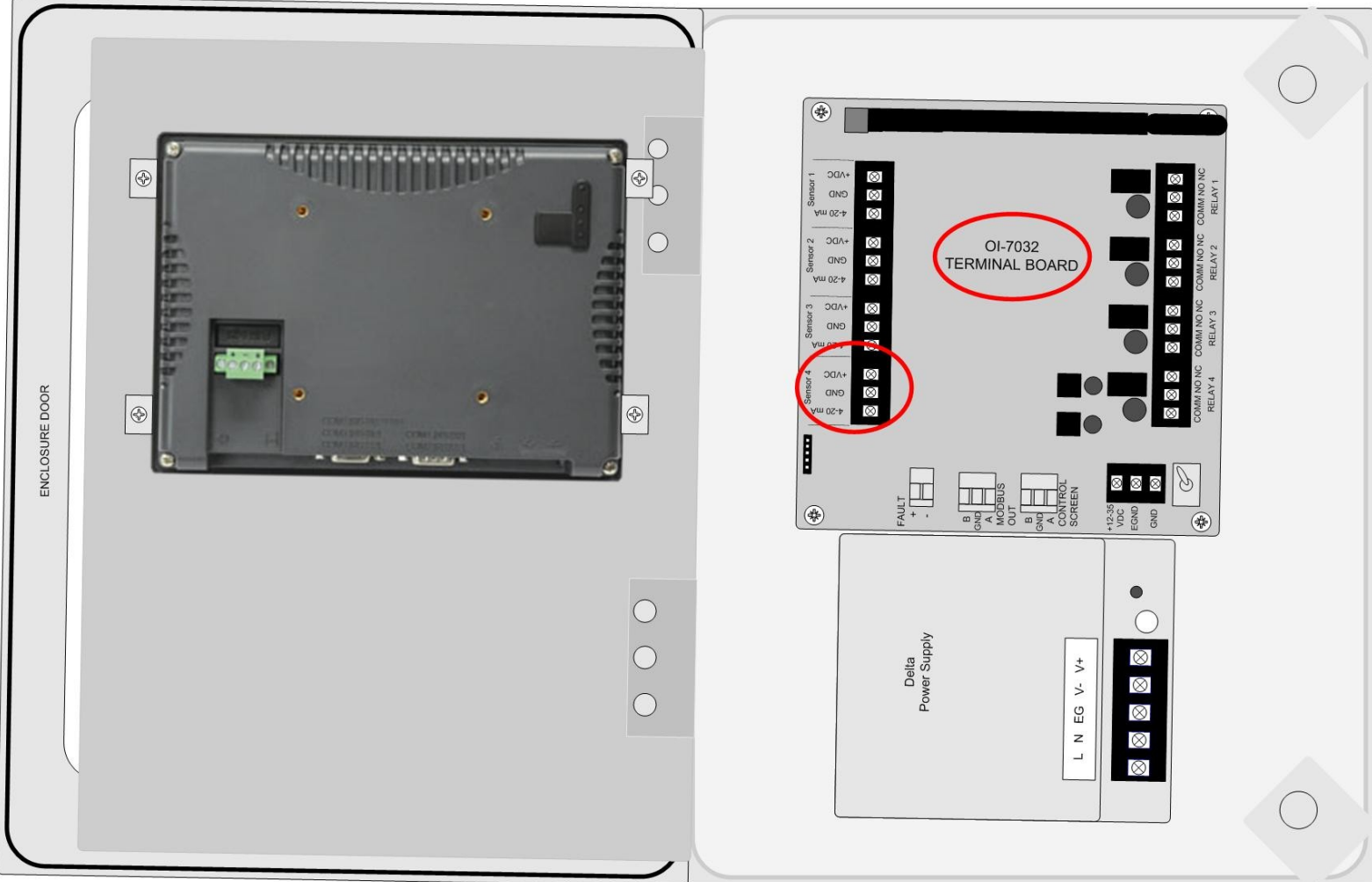

Connecting Sensor 4 cont...

- 2. Connect the positive (red) wire to the terminal labeled “+VDC”.
- 3. Connect the signal (green) wire to the terminal labeled “4-20mA”.
- 4. Connect the neutral (black) wire to the terminal labeled “GND”.

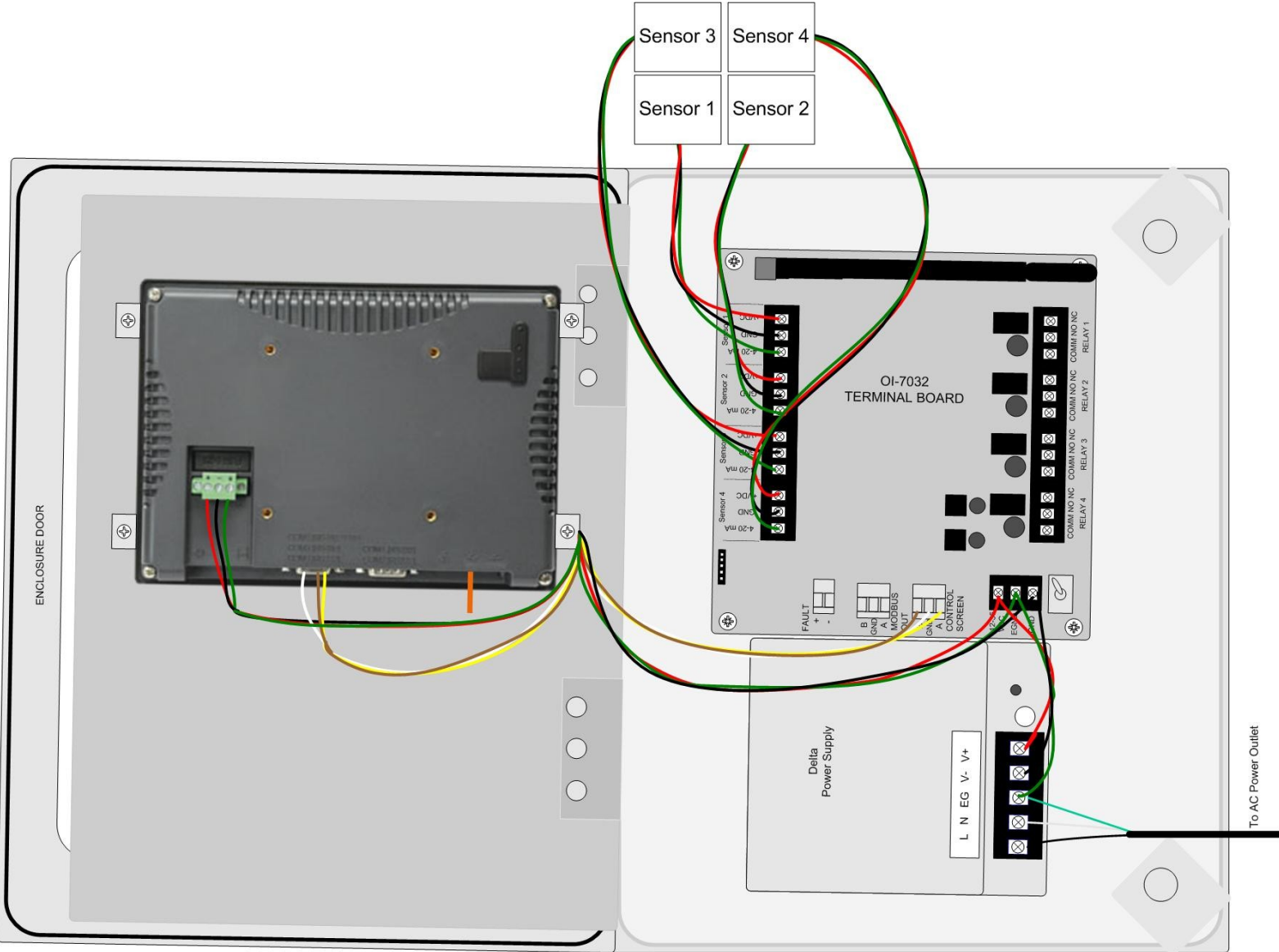

Relay Configurations

The OI-7032 offers four relays to be setup. Each of the four relays may be setup as Normal Open (NO) or Normally Closed (NC).

Connecting Relay 1

- 1. Locate the Relay 1 Terminal Block on the Terminal Board.

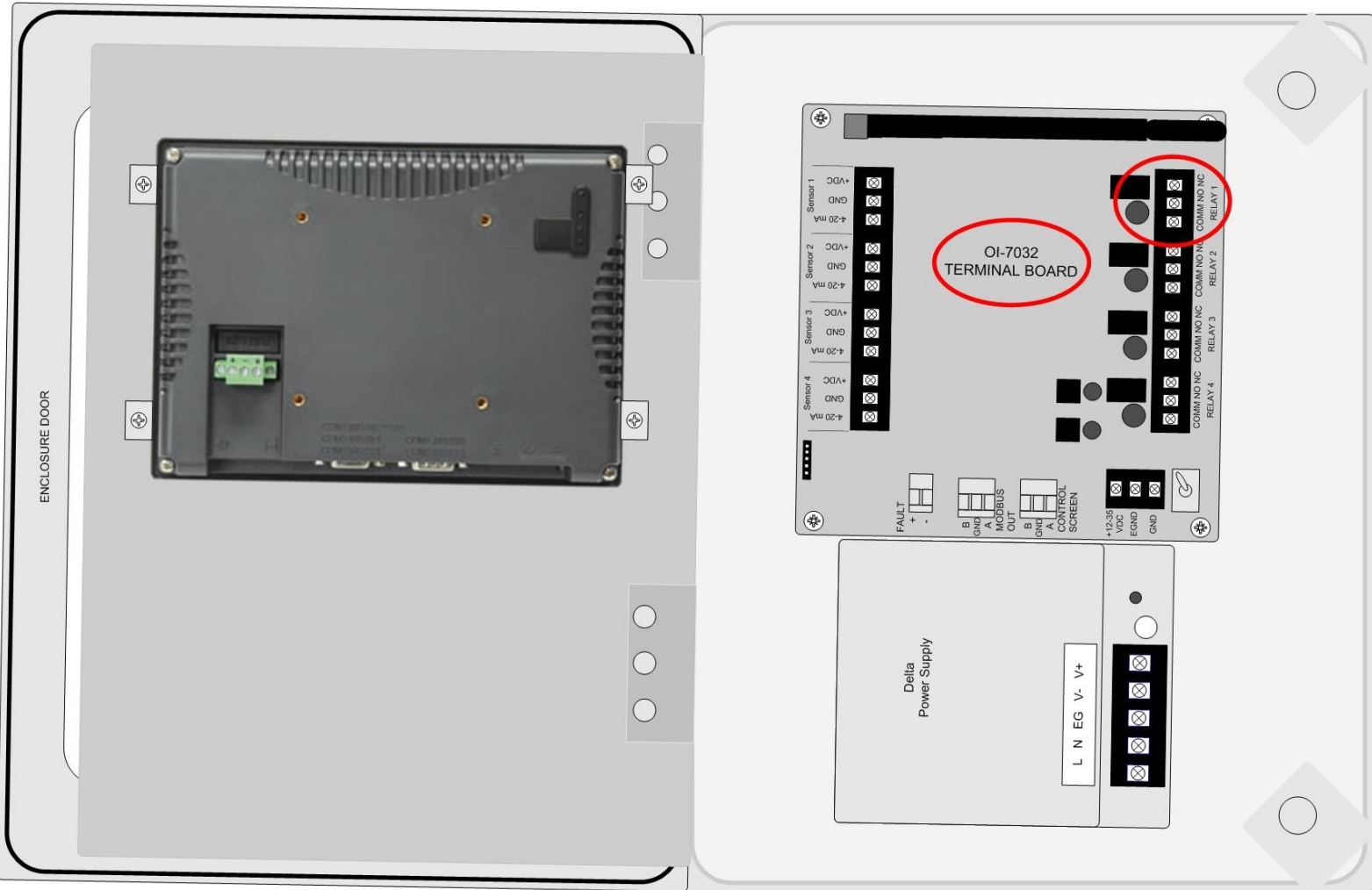

Connecting Relay 1 cont...

2. Connect the live wire (red) from the Relay 1 Alarm (light/horn) to the terminal labeled “NO” (or “NC”) on the Relay 1 Terminal Block.
3. Connect the neutral wire (black) from the Relay 1 Alarm (light/horn) to the terminal labeled “GND” on the DC Power Supply Terminal Block.
4. Connect the jumper wire (blue) from the terminal labeled “+12-35 VDC” on the DC Power Supply Terminal Block to the terminal labeled “COM” on the Relay 1 Terminal Block.

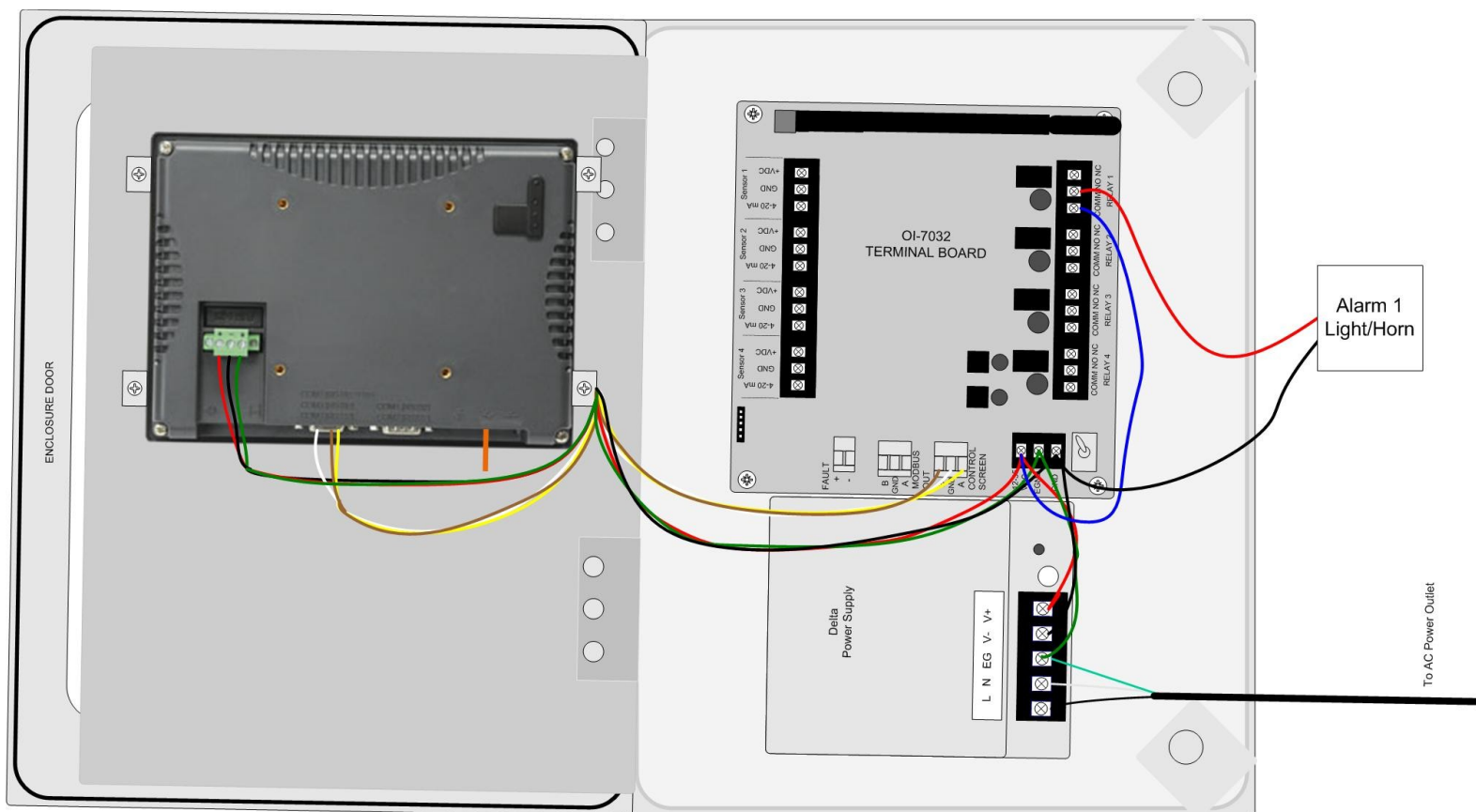

Connecting Relay 2

- 1. Locate the Relay 2 Terminal Block on the Terminal Board.

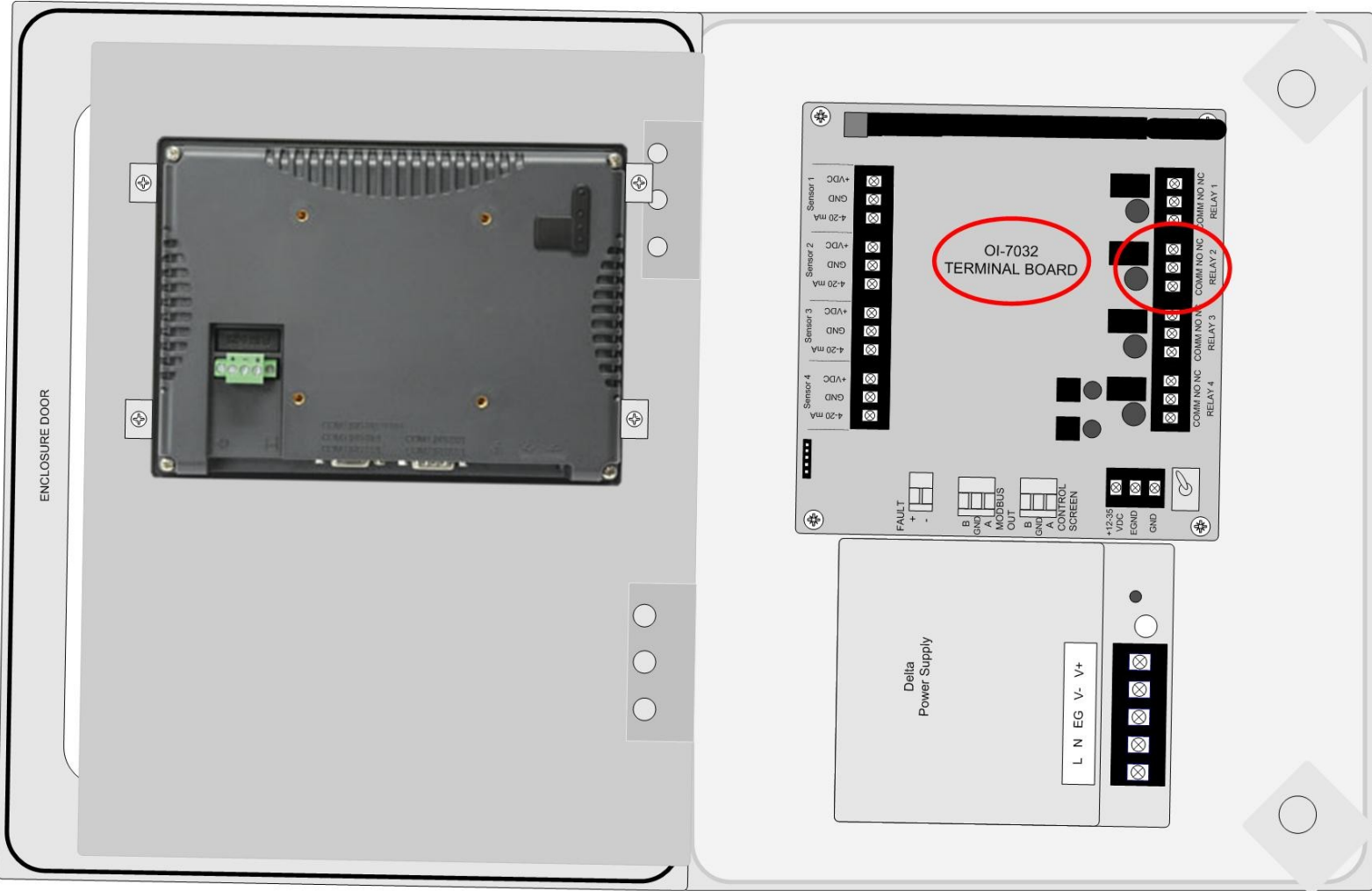

Connecting Relay 2 cont...

2. Connect the live wire (red) from the Relay 2 Alarm (light/horn) to the terminal labeled “NO” (or “NC”) on the Relay 2 Terminal Block.
3. Connect the neutral wire (black) from the Relay 2 Alarm (light/horn) to the terminal labeled “GND” on the DC Power Supply Terminal Block.
4. Connect a jumper wire (blue) from the terminal labeled “COM” on the Relay 1 terminal block to the terminal labeled “COM” on the Relay 2 terminal block.

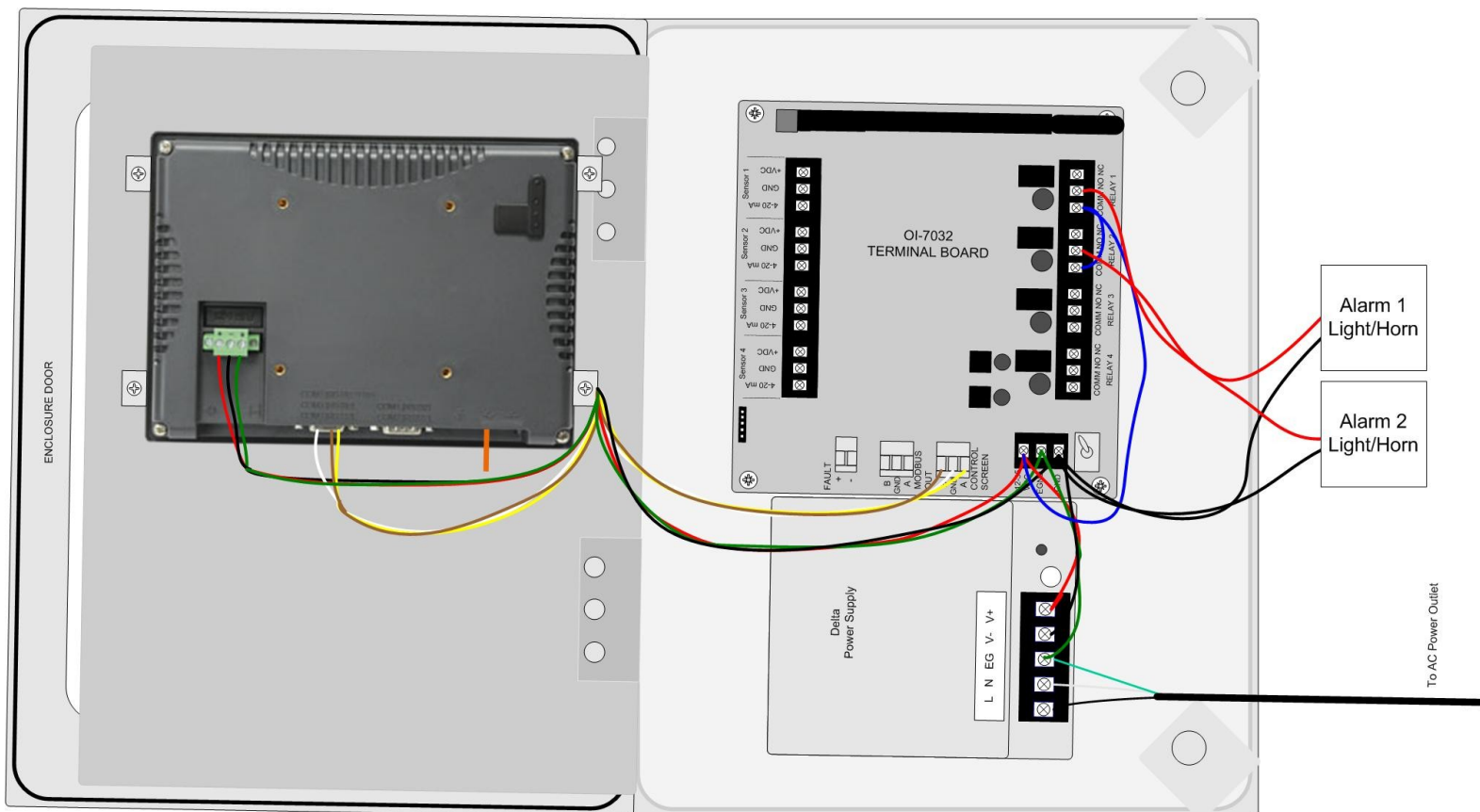

Connecting Relay 3

- 1. Locate the Relay 3 Terminal Block on the Terminal Board.

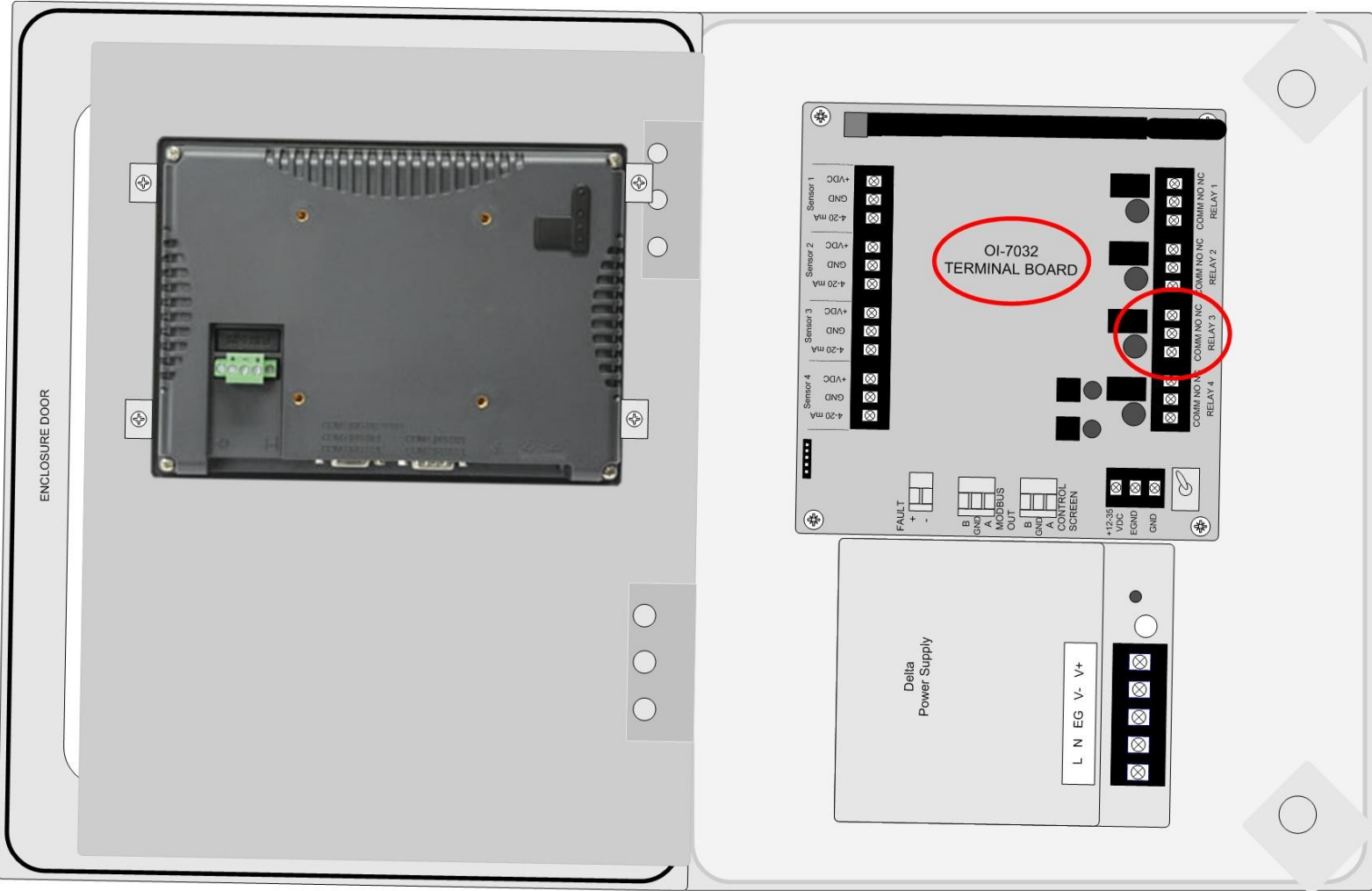

Connecting Relay 3 cont...

2. Connect the live wire (red) from the Relay 3 Alarm (light/horn) to the terminal labeled “NO” (or “NC”) on the Relay 3 Terminal Block.
3. Connect the neutral wire (black) from the Relay 3 Alarm (light/horn) to the terminal labeled “GND” on the DC Power Supply Terminal Block.
4. Connect a jumper wire (blue) from the terminal labeled “COM” on the Relay 2 terminal block to the terminal labeled “COM” on the Relay 3 terminal block.

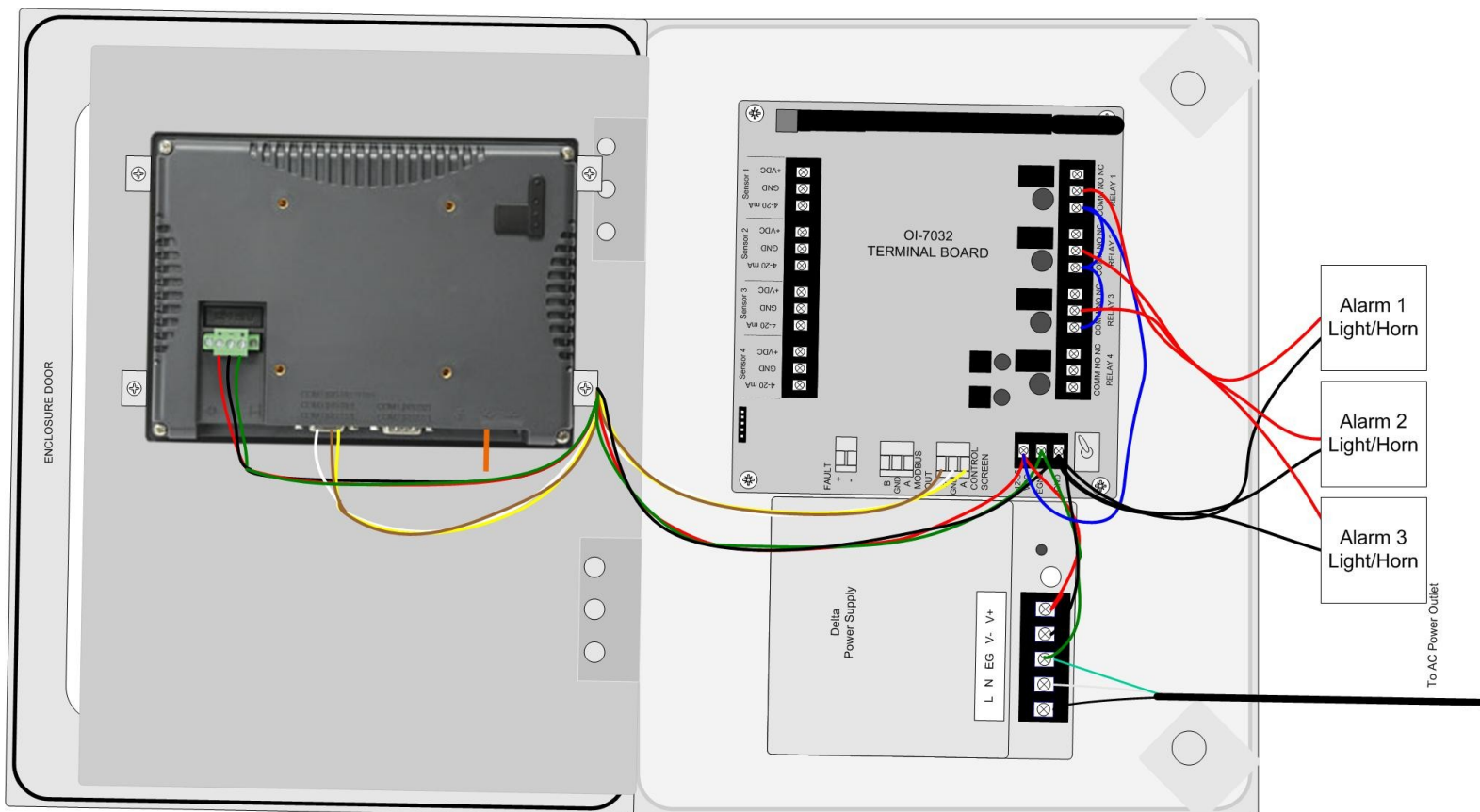

Connecting Relay 4

- 1. Locate the Relay 4 Terminal Block on the Terminal Board.

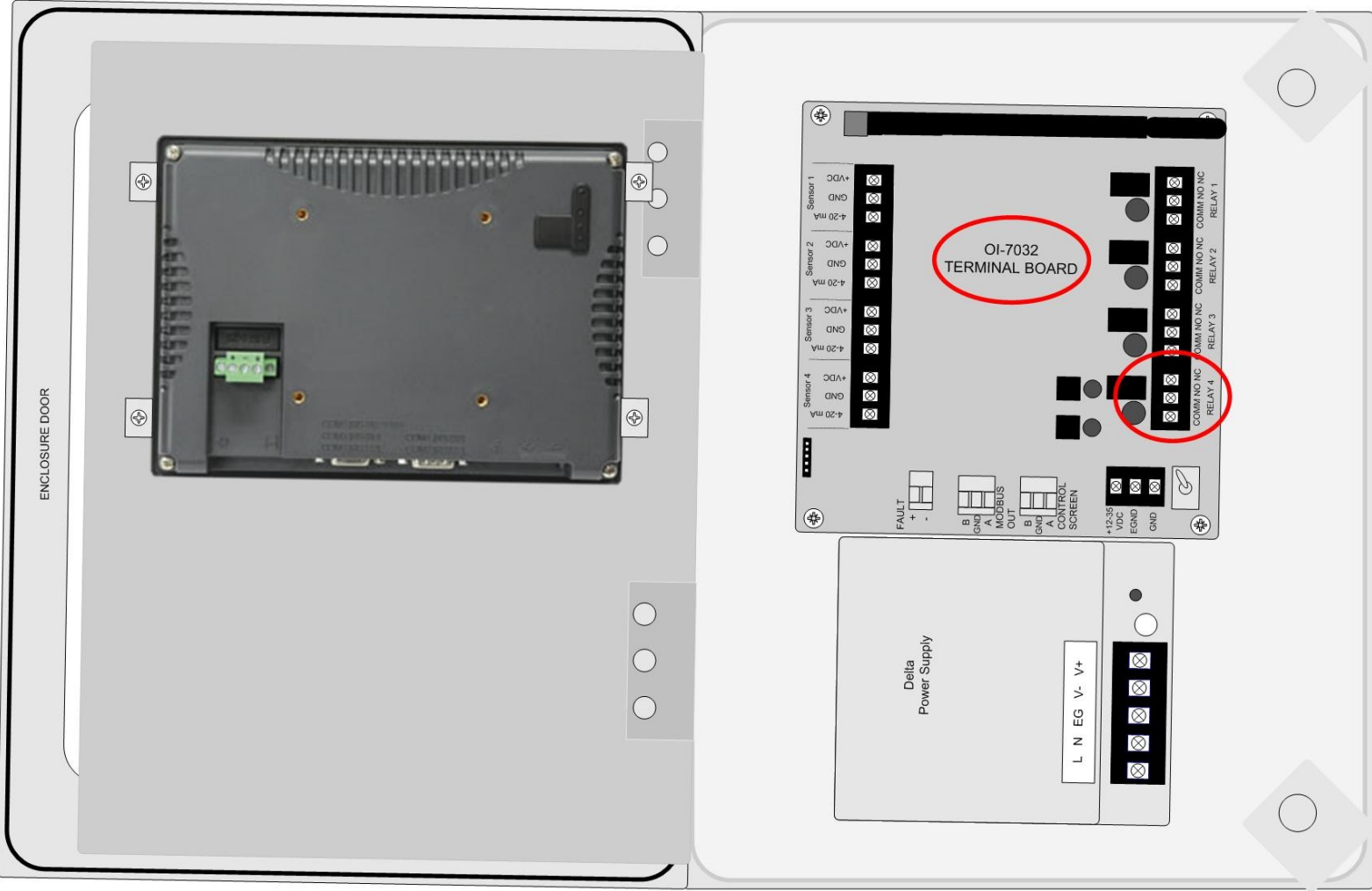

Connecting Relay 4 cont...

2. Connect the live wire (red) from the Relay 4 Alarm (light/horn) to the terminal labeled “NO” (or “NC”) on the Relay 3 Terminal Block.
3. Connect the neutral wire (black) from the Relay 4 Alarm (light/horn) to the terminal labeled “GND” on the DC Power Supply Terminal Block.
4. Connect a jumper wire (blue) from the terminal labeled “COM” on the Relay 3 terminal block to the terminal labeled “COM” on the Relay 4 terminal block.

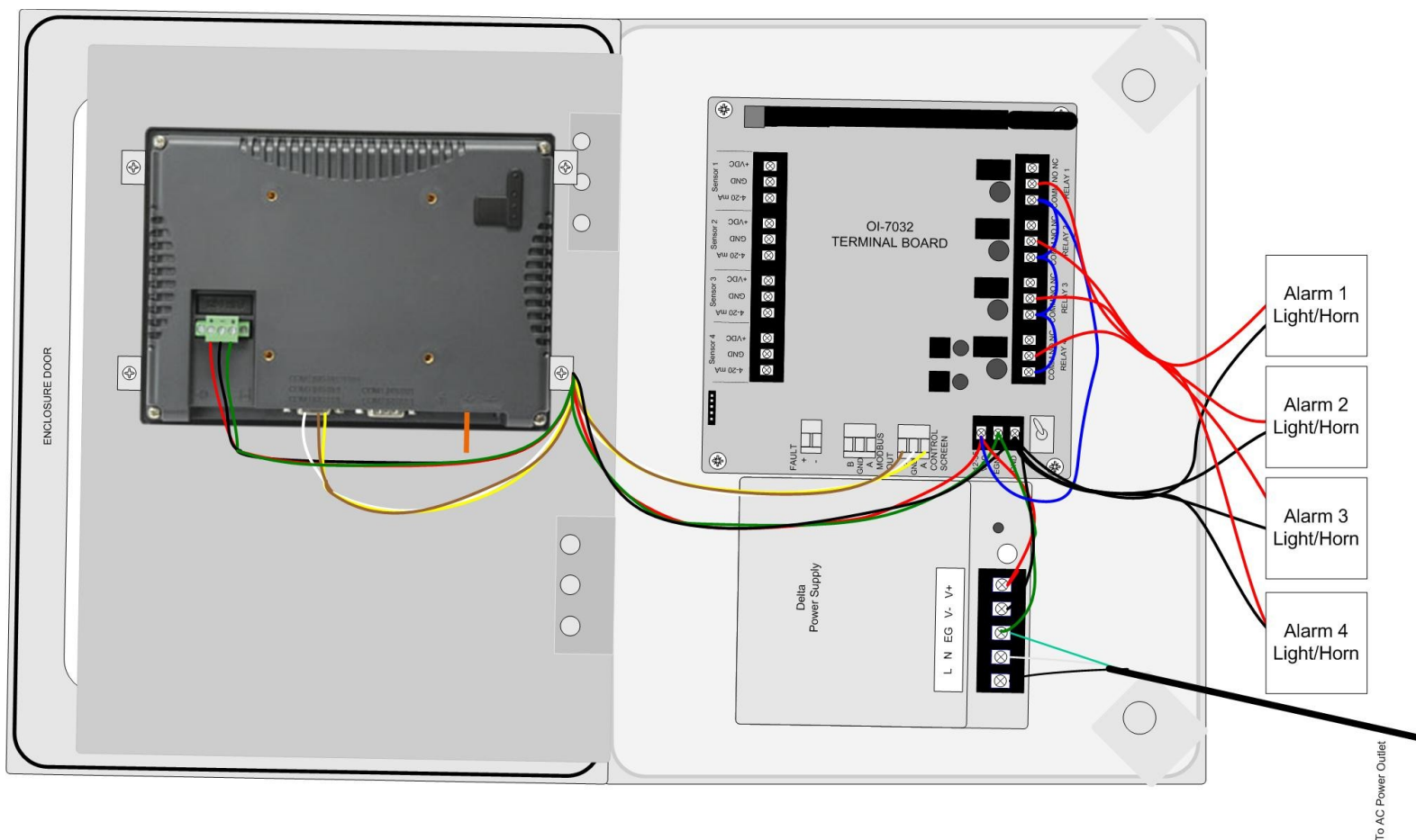

Power On/Off

Powering on the device activates its functions. When powered on, the device is fully functional and access to system and settings menus is allowed.

Once power is supplied to the OI-7032—by being plugged into an AC outlet or by being wired to a DC power supply—the Touchscreen will illuminate.

Basic Operation - Home Screen Navigation

The Home Screen is the Main Menu of the OI-7032, and should be used view indicators, as well as to enter the sub-menus.

NOTE: To return to the Home Screen at any time, press "HOME" on the upper right corner of the Touch Screen.



The options that are included on the Home Screen for direct navigation include:

- Trend Chart
- Real-Time Values
- Autoscroll Off/On
- Channel Configurations
- Fault
- Reset

Indicators that are included on the Home Screen for constant status-monitoring are:

- Relay 1
- Relay 2
- Relay 3
- Relay 4



OI-7032 Generation II Monitor



Software Version 1.0 Firmware Version 1.00.03					
Trend Chart	Real-Time Values	Autoscroll Off	Channel Config		
Relay 1	Relay 2	Relay 3	Relay 4	Fault	Reset

Trend Chart

The Trend Chart allows the user to view logged data for each channel. The Trend Chart menu allows the user to select a group of eight channels, and then view the trends for the selected set.

The trend chart will show data that was recorded over the past week. To view additional data (up to 2 months prior), use the USB that's connected to the back of the Touchscreen.

The Trend Chart screen should be entered from the Home Screen.

- 1. If the Touch Screen is not already displaying the Home Screen, press "Home".



- 2. Press "Trend Chart".



OI-7032 Generation II Monitor



Software Version 1.0 Firmware Version 1.00.03					
Trend Chart	Real-Time Values	Autoscroll Off		Channel Config	
Relay 1	Relay 2	Relay 3	Relay 4	Fault	Reset

The Touchscreen will show the following:

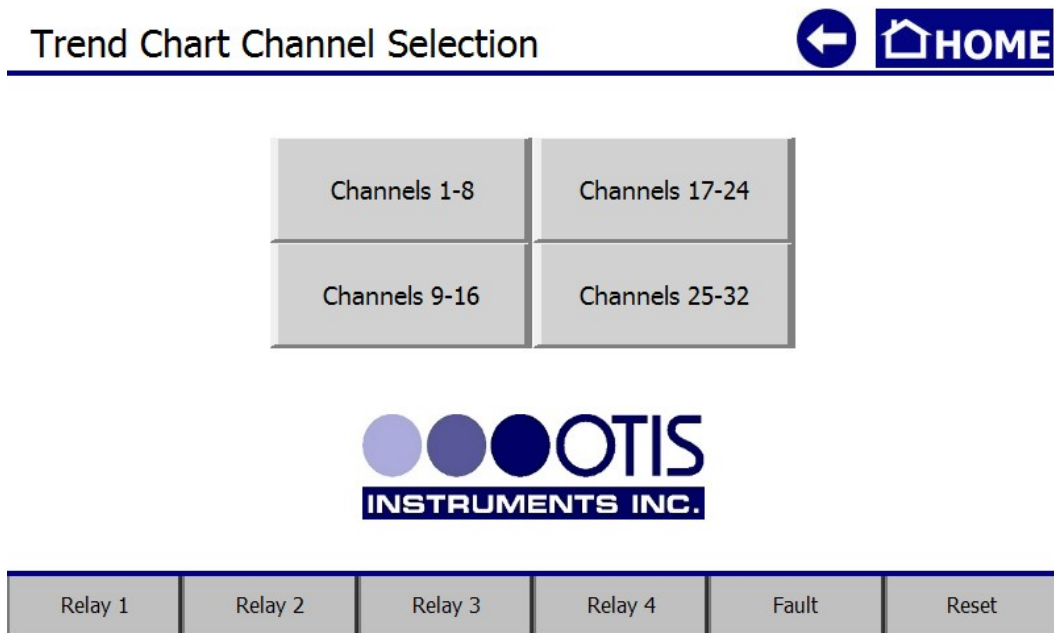

3. Select a channel group to view.

The Touchscreen will show the following (in this example, the group of “Channels 1-8” was chosen):

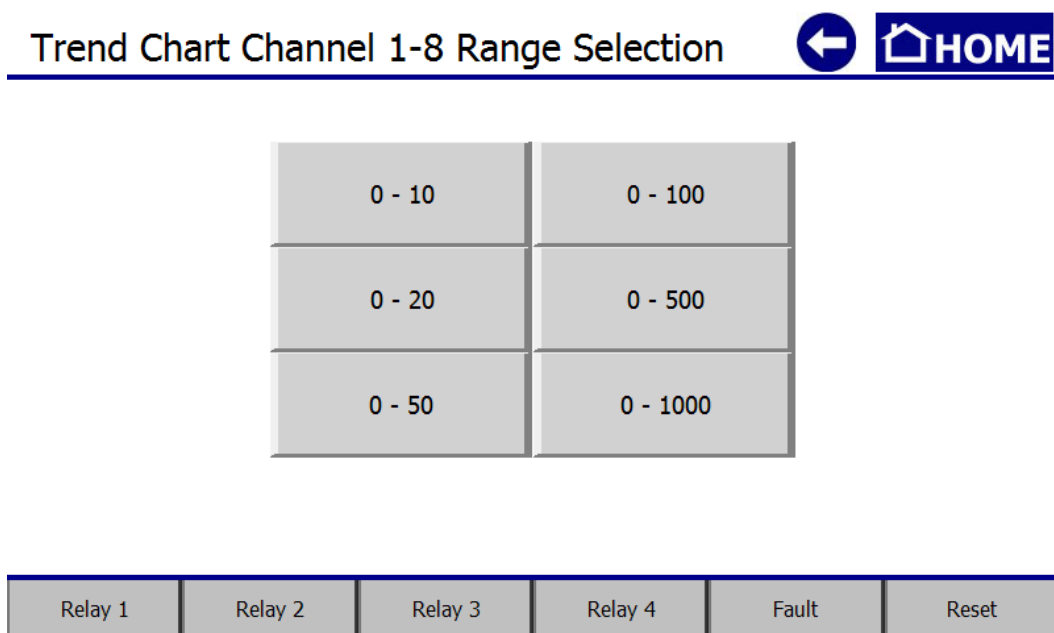

4. Select a range to view.

The Touchscreen will show the following (in this example, the range selection of 0-10 was chosen):

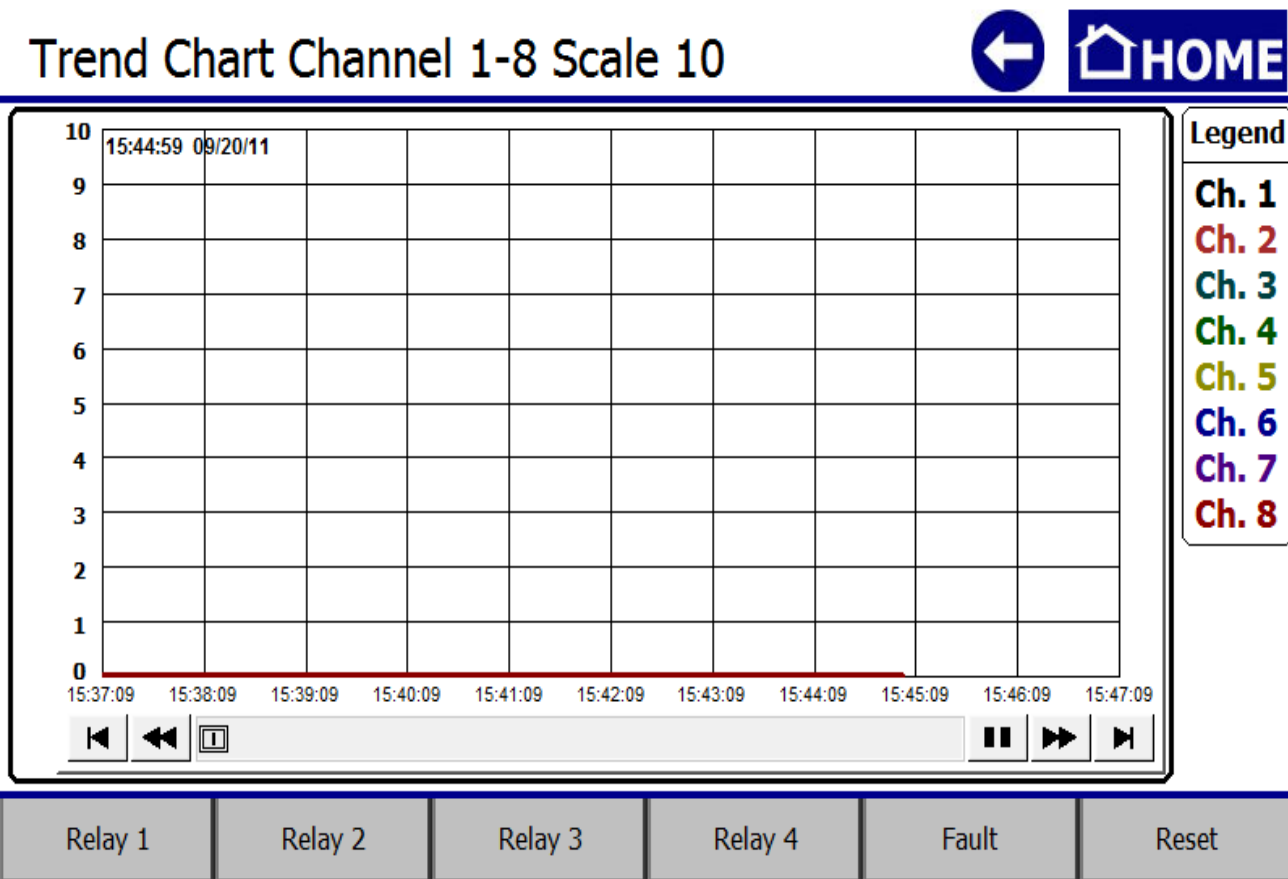

NOTE: Load-time will depend on the amount of recorded data. Please wait until all data has loaded before using the navigation arrows.

5. Use the control arrows along the bottom of the chart to view the available data.
6. Press "Home" to return to the Home Screen when finished viewing the data.

Real-Time Values

The Real-Time Values Screen allows the user to view the current status of each sensor. Status readings include:

- Sensor Location
- Reading
- Address
- Mode
- Battery
- TSLM
- Relays

The Real-Time Values Screen should be entered from the Home Screen.

1. If the Touch Screen is not already displaying the Home Screen, press “Home”.



2. Press “Real-Time Values”.

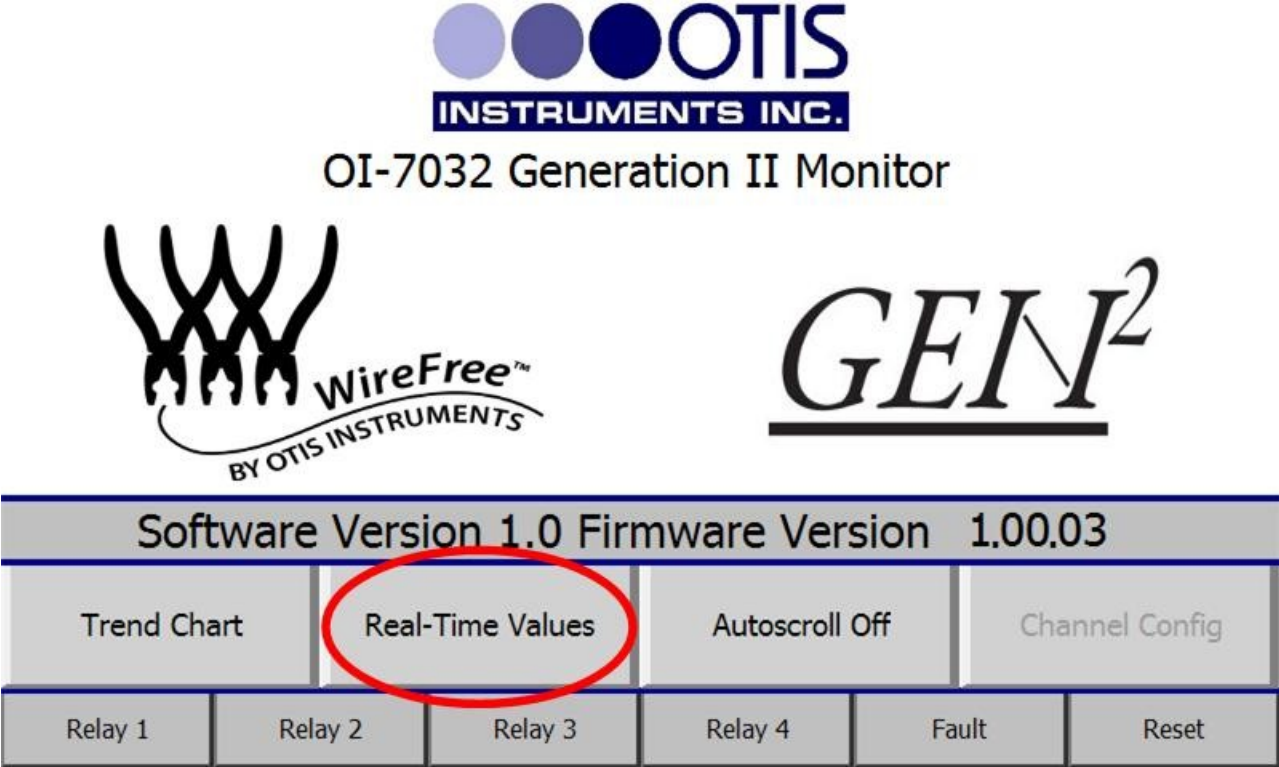

OTIS
INSTRUMENTS INC.
OI-7032 Generation II Monitor

WireFree™
BY OTIS INSTRUMENTS

GEN²

Software Version 1.0 Firmware Version 1.00.03

Trend Chart	Real-Time Values	Autoscroll Off	Channel Config		
Relay 1	Relay 2	Relay 3	Relay 4	Fault	Reset

The Touchscreen will show the following:

Real Time Value Channel Selection

HOME

Channels 1-8	Channels 17-24
Channels 9-16	Channels 25-32

Relay 1	Relay 2	Relay 3	Relay 4	Fault	Reset
---------	---------	---------	---------	-------	-------

3. Select a channel group to view.

The Touchscreen will show the following (in this example, the group of “Channels 25-32” was selected):

Real Time Value Channels 25 - 32

HOME



Channel Status	Sensor Location	Reading	Address	Mode	Battery	TSLM	Relays
Channel 25 On		0.000	25	Normal	0.00	-1	1 2 3 4
Channel 26 On		0.000	26	Normal	0.00	-1	1 2 3 4
Channel 27 On		0.000	27	Normal	0.00	-1	1 2 3 4
Channel 28 On		0.000	28	Normal	0.00	-1	1 2 3 4
Channel 29 On		0.000	29	Normal	0.00	-1	1 2 3 4
Channel 30 On		0.000	30	Normal	0.00	-1	1 2 3 4
Channel 31 On		0.000	31	Normal	0.00	-1	1 2 3 4
Channel 32 On		0.000	32	Normal	0.00	-1	1 2 3 4

Channels 17 - 24	Channels 1 - 8
------------------	----------------

Relay 1	Relay 2	Relay 3	Relay 4	Fault	Reset
---------	---------	---------	---------	-------	-------

- Real-Time Value Data may be viewed from this screen. To view data for additional channels, press either of the “Channels xx – xx” buttons on the lower left/right side of the Touch Screen.

Real Time Value Channels 25 - 32

Channel Status	Sensor Location	Reading	Address	Mode	Battery	TSLM	Relays
Channel 25 On		0.000	25	Normal	0.00	-1	1 2 3 4
Channel 26 On		0.000	26	Normal	0.00	-1	1 2 3 4
Channel 27 On		0.000	27	Normal	0.00	-1	1 2 3 4
Channel 28 On		0.000	28	Normal	0.00	-1	1 2 3 4
Channel 29 On		0.000	29	Normal	0.00	-1	1 2 3 4
Channel 30 On		0.000	30	Normal	0.00	-1	1 2 3 4
Channel 31 On		0.000	31	Normal	0.00	-1	1 2 3 4
Channel 32 On		0.000	32	Normal	0.00	-1	1 2 3 4

Channels 17 - 24

Channels 1 - 8

Relay 1	Relay 2	Relay 3	Relay 4	Fault	Reset
---------	---------	---------	---------	-------	-------

- Press “Home” to return to the Home Screen when finished viewing the data.

Time Since Last Calibration and Null

The Time Since Last Calibration and Null Screen allows the user to view the last time each sensor assembly was calibrated or nulled. The Time Since Last Calibration and Null Screen should be entered from the Real-Time Values Screen via the Home Screen.

The Time Since Last Calibration and Null is recorded every minute. A reading of “0” means the sensor assembly has never been calibrated before, or it has not been a complete day since the previous calibration.

- 1. If the Touch Screen is not already displaying the Home Screen, press “Home”.



- 2. Press “Real-Time Values”.



OI-7032 Generation II Monitor



Software Version 1.0 Firmware Version 1.00.03					
Trend Chart	Real-Time Values	Autoscroll Off	Channel Config		
Relay 1	Relay 2	Relay 3	Relay 4	Fault	Reset

The Touchscreen will show the following:

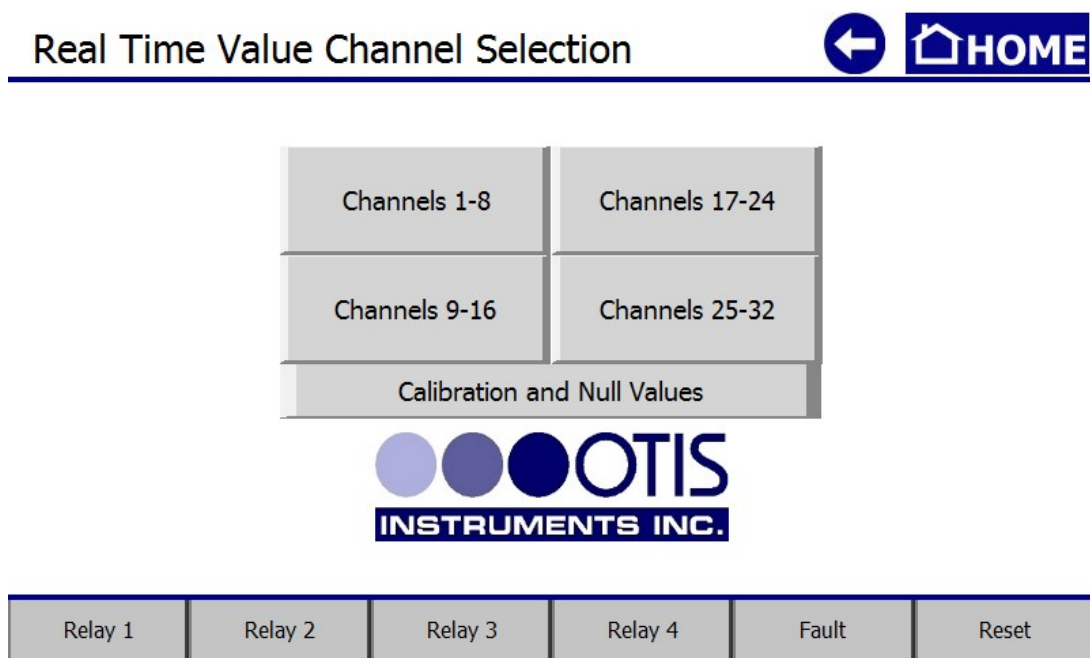

3. Press “Calibration and Null Values”.

The Touchscreen will show the following:

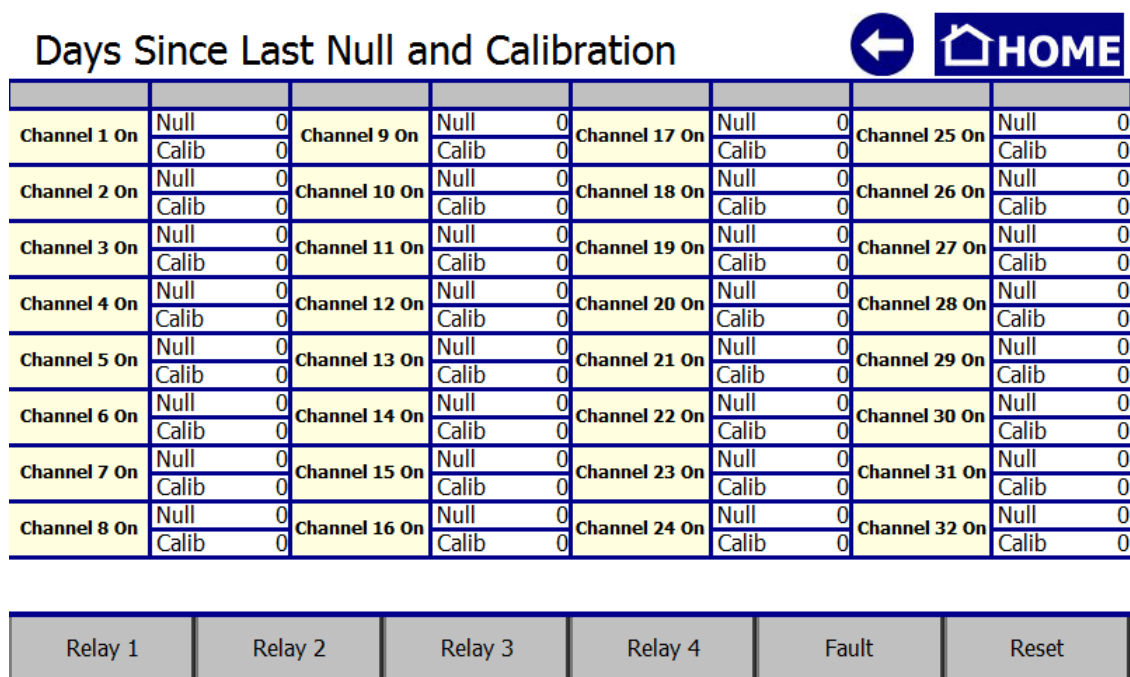

4. Press “Home” to return to the Home Screen when finished viewing the data.

Autoscroll On/Off

Autoscroll may be used to continuously scroll through the current state of each channel. To turn this feature On/Off, simply press “Autoscroll On/Off”.

NOTE: The unit will automatically Autoscroll after 20 seconds of Home Screen inactivity.

In this example, Autoscroll is Off.



OI-7032 Generation II Monitor



Software Version 1.0 Firmware Version 1.00.03

Trend Chart		Real-Time Values		Autoscroll Off		Channel Config	
Relay 1	Relay 2	Relay 3	Relay 4	Fault	Reset		

Channel Configuration

The following instructions should be consulted when configuring the channels for their corresponding sensor assemblies.

Once one channel is setup, these settings may be duplicated for all channels by pressing “Duplicate Setting” on the lower right side of the Touchscreen. Remember, though, that the duplicate settings feature will duplicate the settings for ALL successive channels.

If the settings of channels need to vary, the differing channels should be setup individually. For instances in which a minimal number of channel must vary, setup a channel to reflect the majority, then duplicate that channel's settings. Next, manually setup the few varying channels.

NOTE: The OI-7032 supports a maximum of 32 sensor assemblies. The OI-7032 supports up to 32 WireFree sensor assemblies; up to 4 wired (4-20mA) sensor assemblies may be setup in place of 4 of the 32 WireFree sensor assemblies (for a total of 28 WireFree and 4 Wired).

- 1. Press the WireFree logo to enable the “Channel Config.” button on the Home Screen.



OI-7032 Generation II Monitor



Software Version 1.0		Firmware Version 1.00.03	
Trend Chart	Real-Time Values	Autoscroll Off	Channel Config
Relay 1	Relay 2	Relay 3	Relay 4
		Fault	Reset

2. Press “Channel Config” to enter Channel Configuration Mode. The Touchscreen will show the following:

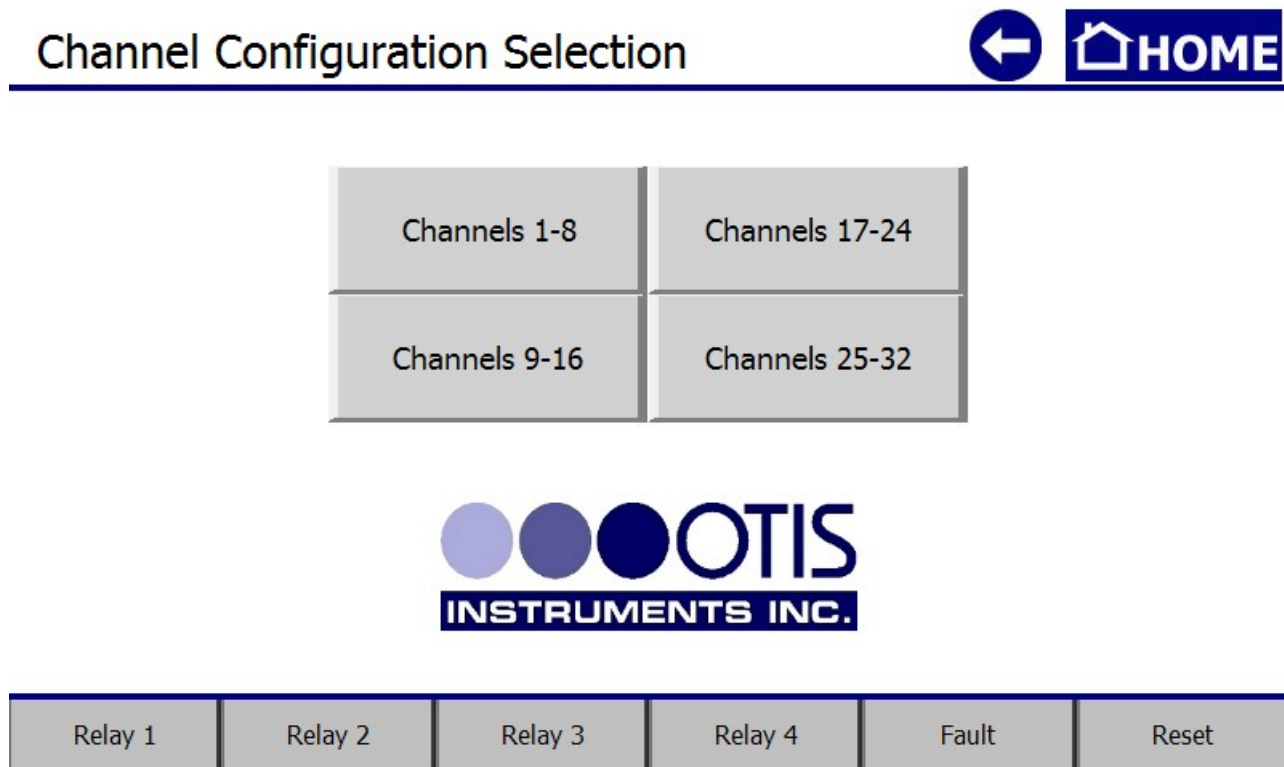

3. Choose a group of channels to configure. The Touchscreen will show the following (in this example, “Channel 1-8” was selected):

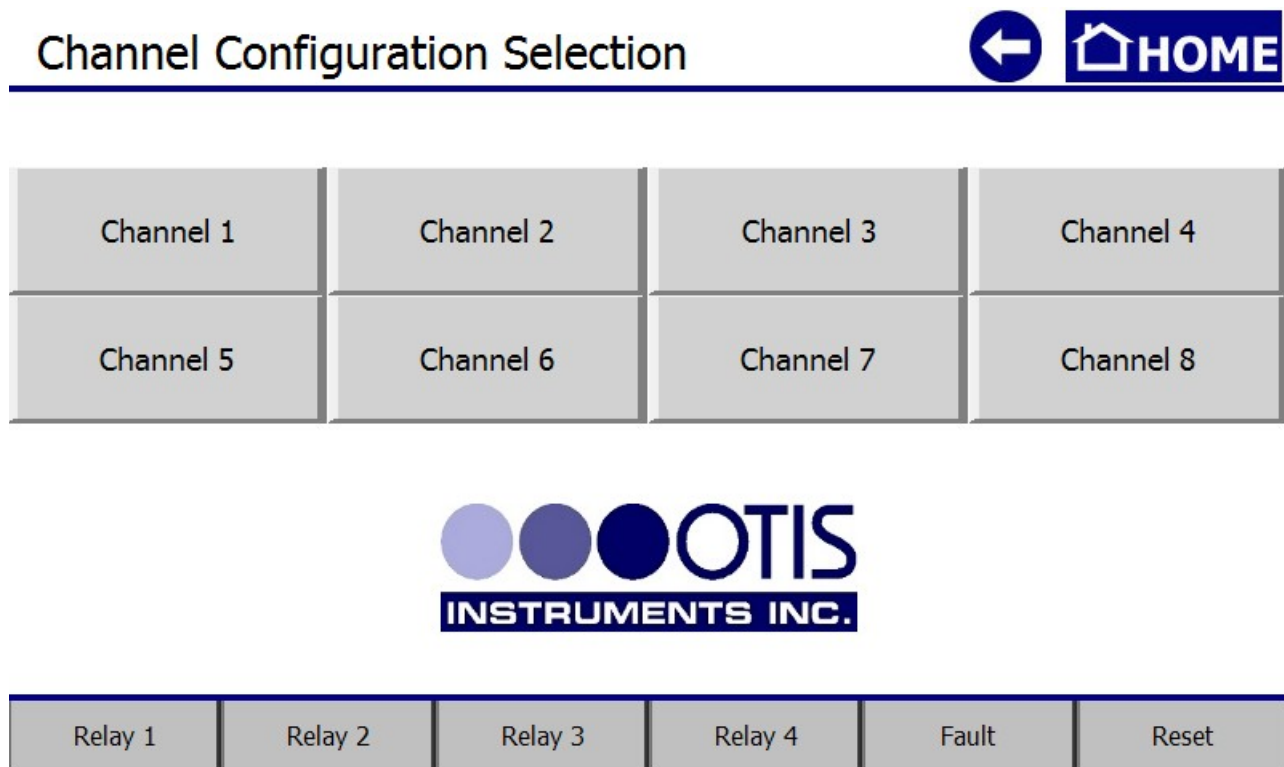

- Choose a channel to configure. The Touchscreen will show the following (in this example, "Channel 1" was selected):

Channel 1 Configuration

HOME

Channel On	Relay 1 On	Relay 2 On	Relay 3 On	Relay 4 On
	Alarm On Rising	Alarm On Rising	Alarm On Rising	Alarm On Rising
	Unlatching	Unlatching	Unlatching	Unlatching
Relay Values	10.000	15.000	20.000	25.000

Radio Address

1

Sensor Location _____

Duplicate Settings



Relay 1	Relay 2	Relay 3	Relay 4	Fault	Reset
---------	---------	---------	---------	-------	-------

- Touch the desired button on the Touchscreen to setup that specific aspect of the sensor assembly.
 - For options that require numbers be typed, a numeric keypad will appear when that option is selected.
 - For options that require letters be typed, an on-screen keyboard will appear when that option is selected.

The following sub-sections provide information and illustrations of options that may be setup in Channel Configuration Mode.

Set as Wired or WireFree (Channels 29-32 ONLY)

To begin configuring the channel, set the channel-type to Wired or WireFree.

Channel 29 Configuration



Channel On	Relay 1 On	Relay 2 On	Relay 3 On	Relay 4 On
	Alarm On Rising	Alarm On Rising	Alarm On Rising	Alarm On Rising
Wirefree	Unlatching	Unlatching	Unlatching	Unlatching
Relay Values	10.000	15.000	20.000	25.000

Address 29 Sensor Location _____ Duplicate Settings

Relay 1	Relay 2	Relay 3	Relay 4	Fault	Reset
---------	---------	---------	---------	-------	-------

Processing

When operations are confirmed, the Touchscreen may display that the operation is being processed. When the following is displayed, please wait until processing is complete (and the green box disappears) before pressing another button.

Channel 1 Configuration

Channel Off	Relay 1 On	Relay 2 On	Relay 3 On	Relay 4 On
Processing	Alarm On Rising	Alarm On Rising	Alarm On Rising	Alarm On Rising
	Unlatching	Unlatching	Unlatching	Unlatching
Relay Values	10.000	15.000	20.000	25.000

Radio Address 1 Sensor Location _____ Duplicate Settings

Relay 1	Relay 2	Relay 3	Relay 4	Fault	Reset
---------	---------	---------	---------	-------	-------

Relay Configuration

To setup the relays for Channel 1, complete the following steps.

1. Press “Relay 1” to turn Relay 1 On/Off. In this example, Relay 1 is On.

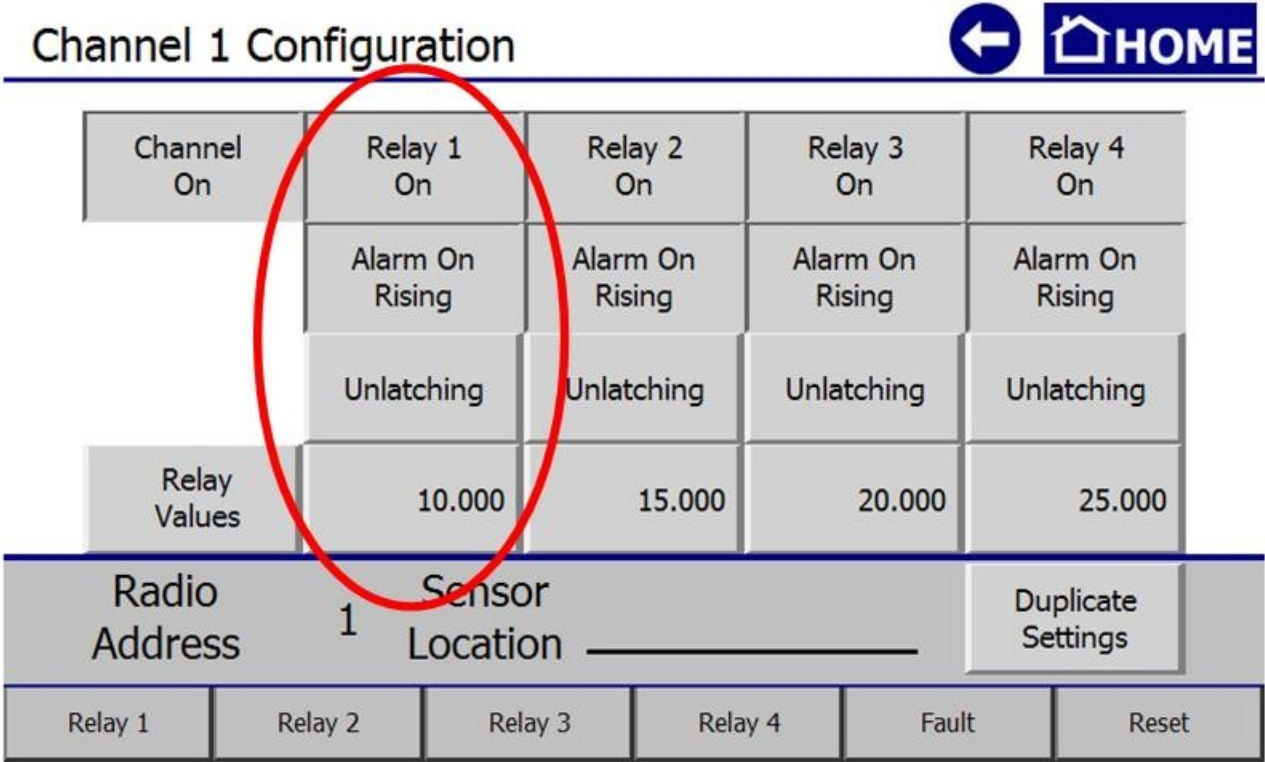

2. Press “Alarm On Rising” (or “Alarm On Falling”) to set Relay 1 as Rising or Falling. In the image above, Relay 1 is set as “Alarm On Rising”.
3. Press “Unlatching” (or “Latching”) in the Relay 1 column to set Relay 1 as Latching or Unlatching. In the image above, Relay 1 is set as Unlatching.
4. Press the value of Relay 1 to set Relay 1's value. In the image above, Relay 1's value is set as “10.000”.

NOTE: The range of values allowed for all relays is 0.001 to 65000. If a value that is outside this range is entered, the previously set value will be used.

5. To set the remaining three relays, simply repeat these steps for each relay. The image above illustrates how each of the relays might be setup in a four-relay application.

NOTE: If the fourth relay is being used as the FAULT relay, it will not be shown on the channel configuration screens.

Setting Radio Address (WireFree)

- 1. To set the radio address, touch the value next to “Radio Address” and wait for the numeric keypad to appear.
- 2. Type the desired address on the keypad, then press “ENT”.

NOTE: The range of available addresses is 1-255.

- *If a value that falls outside this range is entered, the previously set value will be used.*
- *If the user attempts to enter the same address for multiple channels, the next available value will be used.*

Channel 1 Configuration

Channel On	Relay 1 On	Relay 2 On	Relay 3 On	7	8	9	ESC
	Alarm On Rising	Alarm On Rising	Alarm On Rising	4	5	6	CLR
	Unlatching	Unlatching	Unlatching	1	2	3	ENT
				0			
Relay Values	10.000	15.000	20.000	25.000			
Radio Address	1	Sensor Location			Duplicate Settings		
Relay 1	Relay 2	Relay 3	Relay 4	Fault	Reset		

Setting Scale (Wired)

- 1. To set the scale, touch the value next to “Scale” and wait for the numeric keypad to appear.
- 2. Type the desired scale on the keypad, then press “ENT”.

NOTE: The range of available scales is 1 – 65000. If a value that falls outside this range is entered, the previously set value will be used.

Channel 29 Configuration

Channel On	Relay 1 On	Relay 2 On	Relay 3 On	7	8	9	ESC
	Alarm On Rising	Alarm On Rising	Alarm On Rising	4	5	6	CLR
				1	2	3	ENT
Wirefree	Unlatching	Unlatching	Unlatching	0			
Relay Values	10.000	15.000	20.000	25.000			

Scale 100 | **Sensor Location** Flarestack Duplicate Settings

Relay 1	Relay 2	Relay 3	Relay 4	Fault	Reset
---------	---------	---------	---------	-------	-------

Setting Sensor Location

- 1. To specify the sensor location, touch the space to the right of “Sensor Location” and wait for the on-screen keyboard to appear.
- 2. Type the desired sensor location name—up to ten characters—on the keypad, then press “ENT”.

NOTE: To enter lower-case letters, press “Shift”.

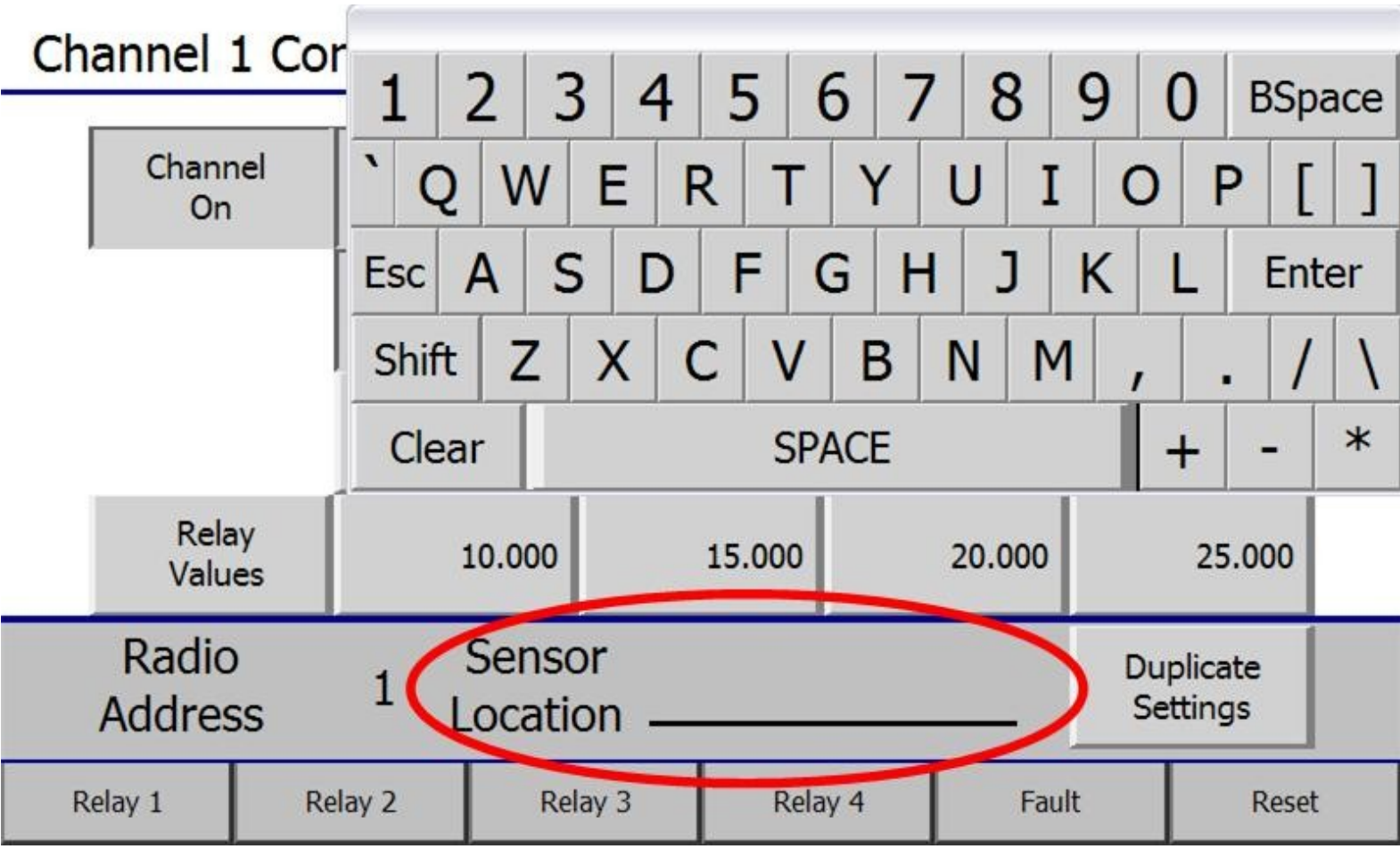



Duplicate Settings

Each channel may be setup individually, or one channel may be setup and then duplicated to all other channels. The “duplicate” feature will set all channels the same way as the one channel that was manually setup.

When the duplicate feature is used:

- The address value is incremented
- All relay settings are copied
- The “Location” is not copied—it must be individually set for each channel.

1. To duplicate the settings of a channel, press “Duplicate Settings”.

Channel 1 Configuration  

Channel On	Relay 1 On	Relay 2 On	Relay 3 On	Relay 4 On	
	Alarm On Rising	Alarm On Rising	Alarm On Rising	Alarm On Rising	
	Unlatching	Unlatching	Unlatching	Unlatching	
Relay Values	10.000	15.000	20.000	25.000	
Radio Address	1	Sensor Location	Duplicate Settings		
Relay 1	Relay 2	Relay 3	Relay 4	Fault	Reset

2. Once the “Duplicate Settings” button has been pressed, the Touchscreen will show the following:

Channel 1 Configuration



Channel On	Relay 1 On	Relay 2 On	Relay 3 On	Relay 4 On	
	Alarm On Rising	Alarm On Rising	Alarm On Rising	Alarm On Rising	
	Unlatching	Unlatching	Unlatching	Unlatching	
Relay Values	10.000	15.000			
Radio Address	1	Sensor Location			
Relay 1	Relay 2	Relay 3	Relay 4	Fault	Reset

Please confirm the operation

3. Press “Yes” to confirm, or “No” to decline, the Duplicate Settings operation.

Channel Off

1. To turn the channel off, press “Channel On”.

← HOME

Channel 1 Configuration

Channel On	Relay 1 On	Relay 2 On	Relay 3 On	Relay 4 On	
	Alarm On Rising	Alarm On Rising	Alarm On Rising	Alarm On Rising	
	Unlatching	Unlatching	Unlatching	Unlatching	
Relay Values	10.000	15.000	20.000	25.000	
Radio Address 1		Sensor Location _____		Duplicate Settings	
Relay 1	Relay 2	Relay 3	Relay 4	Fault	Reset

2. The button will then say “Channel Off”, as illustrated here:

← HOME

Channel 1 Configuration

Channel Off

				Duplicate Settings	
Relay 1	Relay 2	Relay 3	Relay 4	Fault	Reset

NOTE: The Channel On/Off state can be duplicated to all successive channels by pressing the “Duplicate Settings” button.

Configuration Menu Navigation

The Configuration Menu should be used to view/modify any of the following:

- Monitor Serial #
- Date Manufactured
- Calibration Mode
- Relay Tests
- OI-7032 Restart
- Modbus Output Settings (Address; Baud Rate)
- Radio Settings (Radio Timeout)
- Gen II Radio Settings (Network ID; Primary or Secondary Monitor)
- OI-7032 Reset to Factory Default
- Relay Settings (Relays 1-4 (failsafe); Fault Terminal (failsafe); Fault Relay Assign

NOTE: A Second-Level Configuration Menu must be activated to modify some options. For instructions on how to enter and navigate the Second-Level Configuration Menu, see the next section of this Operation Manual.

NOTE: To return to the Home Screen at any time, press "HOME" on the upper right corner of the Touch Screen.



OI-7032 Generation II Monitor



Software Version 1.0 Firmware Version 1.00.03					
Trend Chart	Real-Time Values	Autoscroll Off		Channel Config	
Relay 1	Relay 2	Relay 3	Relay 4	Fault	Reset

Entering Configuration Menu

To enter the Configuration Menu:

- Touch the WireFree logo, then
- Press and hold the GEN II logo until the Touchscreen shows the Configuration Menu.

The Touchscreen will show the following:

Configuration

HOME

Monitor Serial # G65000 Date Manufactured: 02/11/2011

Configuration Settings	Modbus Output Settings	Address	1	Relay Settings	
		Baud Rate	9600 ▼	Relay 1	Not Failsafe
Enter Calibration Mode	Radio Settings	Radio Timeout (Minutes)	10	Relay 2	Not Failsafe
				Relay 3	Not Failsafe
Test Relays	GEN II Radio Settings	Network ID	5	Secondary Monitor	Relay 4 Not Failsafe
				Fault	Failsafe
Restart OI-7032	Reset OI-7032 to Factory Defaults?		Yes	Relay 4 is Fault Relay	No

Relay 1

Relay 2

Relay 3

Relay 4

Fault

Reset

View Monitor Serial

The Monitor Serial # can be viewed on the upper left side of the Touchscreen while in the Configuration Menu.

Configuration HOME

Monitor Serial # **G65000** Date Manufactured: 02/11/2011

Configuration Settings	Modbus Output Settings	Address	1	Relay Settings	
		Baud Rate	9600	Relay 1	Not Failsafe
Enter Calibration Mode	Radio Settings	Radio Timeout (Minutes)	10	Relay 2	Not Failsafe
				Relay 3	Not Failsafe
Test Relays	GEN II Radio Settings	Network ID	5	Relay 4	Not Failsafe
			Secondary Monitor	Fault	Failsafe
Restart OI-7032	Reset OI-7032 to Factory Defaults?	Yes		Relay 4 is Fault Relay	No

Relay 1	Relay 2	Relay 3	Relay 4	Fault	Reset
---------	---------	---------	---------	-------	-------

View Date Manufactured

The Date Manufactured can be viewed on the upper right side of the Touchscreen while in the Configuration Menu.

Configuration HOME

Monitor Serial # G65000 **Date Manufactured: 02/11/2011**

Configuration Settings	Modbus Output Settings	Address	1	Relay Settings	
		Baud Rate	9600	Relay 1	Not Failsafe
Enter Calibration Mode	Radio Settings	Radio Timeout (Minutes)	10	Relay 2	Not Failsafe
				Relay 3	Not Failsafe
Test Relays	GEN II Radio Settings	Network ID	5	Relay 4	Not Failsafe
			Secondary Monitor	Fault	Failsafe
Restart OI-7032	Reset OI-7032 to Factory Defaults?	Yes		Relay 4 is Fault Relay	No

Relay 1	Relay 2	Relay 3	Relay 4	Fault	Reset
---------	---------	---------	---------	-------	-------

Calibration Mode

While in the Configuration Menu, press “Enter Calibration Mode” to put the OI-7032 in Calibration Mode.

Configuration
HOME

Monitor Serial # G65000 Date Manufactured: 02/11/2011

Configuration Settings	Modbus Output Settings	Address	1	Relay Settings	
		Baud Rate	9600	Relay 1	Not Failsafe
Enter Calibration Mode	Radio Settings	Radio Timeout (Minutes)	10	Relay 2	Not Failsafe
				Relay 3	Not Failsafe
Test Relays	GEN II Radio Settings	Network ID	5	Relay 4	Not Failsafe
			Secondary Monitor	Fault	Failsafe
Restart OI-7032	Reset OI-7032 to Factory Defaults?		Yes	Relay 4 is Fault Relay	No

Relay 1

Relay 2

Relay 3

Relay 4

Fault

Reset

While in Calibration Mode, the Touchscreen will show the following:

Configuration
HOME

Monitor Serial # G65000 Date Manufactured: 02/11/2011

Configuration Settings	Modbus Output Settings	Address	1	Relay Settings	
		Baud Rate	9600	Relay 1	Not Failsafe
Calibration Mode Active	Radio Settings	Radio Timeout (Minutes)	10	Relay 2	Not Failsafe
				Relay 3	Not Failsafe
Test Relays	GEN II Radio Settings	Network ID	5	Relay 4	Not Failsafe
			Secondary Monitor	Fault	Failsafe
Restart OI-7032	Reset OI-7032 to Factory Defaults?		Yes	Relay 4 is Fault Relay	No

CALIBRATION MODE

Reset

To exit Calibration Mode, touch “Calibration Mode Active” or “Reset”.

HOME

Configuration

Monitor Serial # G65000 Date Manufactured: 02/11/2011

Configuration Settings	Modbus Output Settings	Address	1	Relay Settings
		Baud Rate	9600	Relay 1 Not Failsafe
Calibration Mode Active	Radio Settings	Radio Timeout (Minutes)	10	Relay 2 Not Failsafe
				Relay 3 Not Failsafe
Test Relays	GEN II Radio Settings	Network ID	5	Secondary Monitor
				Relay 4 Not Failsafe
				Fault Failsafe
Restart OI-7032	Reset OI-7032 to Factory Defaults?	Yes		Relay 4 is Fault Relay No

OTIS INSTRUMENTS INC.

CALIBRATION MODE Reset

Relay Tests

While in the Configuration Menu, press “Test Relays”.

HOME

Configuration

Monitor Serial # G65000 Date Manufactured: 02/11/2011

Configuration Settings	Modbus Output Settings	Address	1	Relay Settings
		Baud Rate	9600	Relay 1 Not Failsafe
Enter Calibration Mode	Radio Settings	Radio Timeout (Minutes)	10	Relay 2 Not Failsafe
				Relay 3 Not Failsafe
Test Relays	GEN II Radio Settings	Network ID	5	Secondary Monitor
				Relay 4 Not Failsafe
				Fault Failsafe
Restart OI-7032	Reset OI-7032 to Factory Defaults?	Yes		Relay 4 is Fault Relay No

OTIS INSTRUMENTS INC.

Relay 1	Relay 2	Relay 3	Relay 4	Fault	Reset
---------	---------	---------	---------	-------	-------

When in Relay Test Mode, the Touchscreen will consecutively light each Relay (in red) every 5 seconds. To cancel the Relay Test, press “Testing Relays” or “Reset”. When all 4 relays have been tested (and passed), the Touchscreen will look like the following illustration (before automatically returning to the regular Configuration Menu view):



Monitor Serial # G65000		Date Manufactured: 02/11/2011		
Configuration Settings	Modbus Output Settings	Address Baud Rate	1 9600	
Enter Calibration Mode	Radio Settings	Radio Timeout (Minutes)	10	
			Relay 1	Not Failsafe
Testing Relays	GEN II Radio Settings	Network ID	5	
			Relay 2	Not Failsafe
Restart OI-7032	Reset OI-7032 to Factory Defaults?	Yes	Secondary Monitor	
			Relay 3	Not Failsafe
			Relay 4	Not Failsafe
			Fault	Failsafe
			Relay 4 is Fault Relay	No



Relay 1	Relay 2	Relay 3	Relay 4	Fault	Reset
---------	---------	---------	---------	-------	-------

OI-7032 Restart

While in the Configuration Menu, press “Restart OI-7032” to restart the Terminal Board. A pop-up will appear for action-confirmation. Press “Yes” to confirm, or “No” to decline.



Monitor Serial # G65000		Date Manufactured: 02/11/2011		
Configuration Settings	Modbus Output Settings	Address Baud Rate	1 9600	
Enter Calibration Mode	Radio Settings	Radio Timeout (Minutes)	10	
			Relay 1	Not Failsafe
Test Relays	GEN II Radio Settings	Network ID	5	
			Relay 2	Not Failsafe
Restart OI-7032	Reset OI-7032 to Factory Defaults?	Yes	Secondary Monitor	
			Relay 3	Not Failsafe
			Relay 4	Not Failsafe
			Fault	Failsafe
			Relay 4 is Fault Relay	No



Relay 1	Relay 2	Relay 3	Relay 4	Fault	Reset
---------	---------	---------	---------	-------	-------

VIEW Modbus Output Settings: Address

While in the Configuration Menu, the address can be viewed in the Modbus Output Settings box. To modify the Address, consult the next section of this Operation Manual “Second-Level Modifications – Configuration Menu”.



Configuration		Monitor Serial # G65000		Date Manufactured: 02/11/2011	
Configuration Settings	Modbus Output Settings	Address	1	Relay Settings	
		Baud Rate	9600	Relay 1	Not Failsafe
Enter Calibration Mode	Radio Settings	Radio Timeout (Minutes)	10	Relay 2	Not Failsafe
				Relay 3	Not Failsafe
Test Relays	GEN II Radio Settings	Network ID	5	Relay 4	Not Failsafe
			Secondary Monitor	Fault	Failsafe
Restart OI-7032	Reset OI-7032 to Factory Defaults?		Yes	Relay 4 is Fault Relay	No



Relay 1	Relay 2	Relay 3	Relay 4	Fault	Reset
---------	---------	---------	---------	-------	-------

VIEW Modbus Output Settings: Baud Rate

While in the Configuration Menu, the Baud Rate can be viewed in the Modbus Output Settings box. To modify the Baud Rate, consult the next section of this Operation Manual “Second-Level Modifications – Configuration Menu”.



Configuration		Monitor Serial # G65000		Date Manufactured: 02/11/2011	
Configuration Settings	Modbus Output Settings	Address	1	Relay Settings	
		Baud Rate	9600	Relay 1	Not Failsafe
Enter Calibration Mode	Radio Settings	Radio Timeout (Minutes)	10	Relay 2	Not Failsafe
				Relay 3	Not Failsafe
Test Relays	GEN II Radio Settings	Network ID	5	Relay 4	Not Failsafe
			Secondary Monitor	Fault	Failsafe
Restart OI-7032	Reset OI-7032 to Factory Defaults?		Yes	Relay 4 is Fault Relay	No



Relay 1	Relay 2	Relay 3	Relay 4	Fault	Reset
---------	---------	---------	---------	-------	-------

VIEW Radio Settings: Radio Timeout

While in the Configuration Menu, the Radio Timeout can be viewed in the Radio Settings box. To modify the Radio Settings, consult the next section of this Operation Manual “Second-Level Modifications – Configuration Menu”.



Monitor Serial # G65000		Date Manufactured: 02/11/2011		
Configuration Settings	Modbus Output Settings	Address	1	Relay Settings
		Baud Rate	9600	Relay 1 Not Failsafe
Enter Calibration Mode	Radio Settings	Radio Timeout (Minutes)	10	Relay 2 Not Failsafe
				Relay 3 Not Failsafe
Test Relays	GEN II Radio Settings	Network ID	5	Relay 4 Not Failsafe
			Secondary Monitor	Fault Failsafe
Restart OI-7032	Reset OI-7032 to Factory Defaults?		Yes	Relay 4 is Fault Relay No



Relay 1	Relay 2	Relay 3	Relay 4	Fault	Reset
---------	---------	---------	---------	-------	-------

VIEW Gen II Radio Settings: Network ID

While in the Configuration Menu, the Network ID can be viewed in the Gen II Radio Settings box. To modify the Gen II Radio Settings, consult the next section of this Operation Manual “Second-Level Modifications – Configuration Menu”.



Monitor Serial # G65000		Date Manufactured: 02/11/2011		
Configuration Settings	Modbus Output Settings	Address	1	Relay Settings
		Baud Rate	9600	Relay 1 Not Failsafe
Enter Calibration Mode	Radio Settings	Radio Timeout (Minutes)	10	Relay 2 Not Failsafe
				Relay 3 Not Failsafe
Test Relays	GEN II Radio Settings	Network ID	5	Relay 4 Not Failsafe
			Secondary Monitor	Fault Failsafe
Restart OI-7032	Reset OI-7032 to Factory Defaults?		Yes	Relay 4 is Fault Relay No



Relay 1	Relay 2	Relay 3	Relay 4	Fault	Reset
---------	---------	---------	---------	-------	-------

VIEW Gen II Radio Settings: Primary or Secondary Monitor

While in the Configuration Menu, the monitor can view the “Primary/Secondary Monitor” setting in the Gen II Radio Settings box. To modify the Gen II Radio Settings, consult the next section of this Operation Manual “Second-Level Modifications – Configuration Menu”.



Configuration		Monitor Serial # G65000 Date Manufactured: 02/11/2011			
Configuration Settings	Modbus Output Settings	Address	1	Relay Settings	
		Baud Rate	9600	Relay 1	Not Failsafe
Enter Calibration Mode	Radio Settings	Radio Timeout (Minutes)	10	Relay 2	Not Failsafe
				Relay 3	Not Failsafe
Test Relays	GEN II Radio Settings	Network ID	5	Relay 4	Not Failsafe
			Secondary Monitor	Fault	Failsafe
Restart OI-7032	Reset OI-7032 to Factory Defaults?		Yes	Relay 4 is Fault Relay	No



Relay 1	Relay 2	Relay 3	Relay 4	Fault	Reset
---------	---------	---------	---------	-------	-------

VIEW OI-7032 Reset to Factory Default

While in the Configuration Menu, the user can view the OI-7032 to the factory default settings in the Reset OI-7032 to Factory Defaults? box. To enable the Factory Default Yes/No button, consult the next section of this Operation Manual “Second-Level Modifications – Configuration Menu”.



Configuration		Monitor Serial # G65000 Date Manufactured: 02/11/2011			
Configuration Settings	Modbus Output Settings	Address	1	Relay Settings	
		Baud Rate	9600	Relay 1	Not Failsafe
Enter Calibration Mode	Radio Settings	Radio Timeout (Minutes)	10	Relay 2	Not Failsafe
				Relay 3	Not Failsafe
Test Relays	GEN II Radio Settings	Network ID	5	Relay 4	Not Failsafe
			Secondary Monitor	Fault	Failsafe
Restart OI-7032	Reset OI-7032 to Factory Defaults?		Yes	Relay 4 is Fault Relay	No



Relay 1	Relay 2	Relay 3	Relay 4	Fault	Reset
---------	---------	---------	---------	-------	-------

VIEW Relay Settings: Relays 1-4 (Failsafe)

While in the Configuration Menu, the user can view the Relay Failsafe (1-4) setting next to the corresponding relay number in the Relay 1, 2, 3 or 4 box. To modify the Relay Failsafe settings, consult the next section of this Operation Manual “Second-Level Modifications – Configuration Menu”.

HOME

Configuration

Monitor Serial # G65000 Date Manufactured: 02/11/2011

Configuration Settings	Modbus Output Settings	Address	1	Relay Settings
		Baud Rate	9600	Relay 1 Not Failsafe
Enter Calibration Mode	Radio Settings	Radio Timeout (Minutes)	10	Relay 2 Not Failsafe
				Relay 3 Not Failsafe
Test Relays	GEN II Radio Settings	Network ID	5	Relay 4 Not Failsafe
		Secondary Monitor		Fault Not Failsafe
Restart OI-7032	Reset OI-7032 to Factory Defaults?	Yes		Relay 4 is Fault Relay No

OTIS INSTRUMENTS INC.

Relay 1	Relay 2	Relay 3	Relay 4	Fault	Reset
---------	---------	---------	---------	-------	-------

VIEW Relay Settings: Fault Terminal

While in the Configuration Menu, the user can view the Fault Terminal Failsafe setting in the Fault box. To modify the Fault Terminal Failsafe setting, consult the next section of this Operation Manual “Second-Level Modifications – Configuration Menu”.

HOME

Configuration

Monitor Serial # G65000 Date Manufactured: 02/11/2011

Configuration Settings	Modbus Output Settings	Address	1	Relay Settings
		Baud Rate	9600	Relay 1 Not Failsafe
Enter Calibration Mode	Radio Settings	Radio Timeout (Minutes)	10	Relay 2 Not Failsafe
				Relay 3 Not Failsafe
Test Relays	GEN II Radio Settings	Network ID	5	Relay 4 Not Failsafe
		Secondary Monitor		Fault Failsafe
Restart OI-7032	Reset OI-7032 to Factory Defaults?	Yes		Relay 4 is Fault Relay No

OTIS INSTRUMENTS INC.

Relay 1	Relay 2	Relay 3	Relay 4	Fault	Reset
---------	---------	---------	---------	-------	-------

VIEW Relay Settings: Fault Relay Assign

While in the Configuration Menu, the user can view the Relay 4 Fault Relay setting in the “Relay 4 is Fault Relay” box. To modify the Relay 4 fault relay assignment, consult the next section of this Operation Manual “Second-Level Modifications – Configuration Menu”.

Configuration						
Monitor Serial # G65000		Date Manufactured: 02/11/2011				
Configuration Settings	Modbus Output Settings	Address	1	Relay Settings		
		Baud Rate	9600	Relay 1	Not Failsafe	
Enter Calibration Mode	Radio Settings	Radio Timeout (Minutes)	10	Relay 2	Not Failsafe	
				Relay 3	Not Failsafe	
Test Relays	GEN II Radio Settings	Network ID	5	Secondary Monitor	Relay 4	Not Failsafe
				Fault	Failsafe	
Restart OI-7032	Reset OI-7032 to Factory Defaults?		Yes	Relay 4 is Fault Relay	No	



Relay 1	Relay 2	Relay 3	Relay 4	Fault	Reset
---------	---------	---------	---------	-------	-------

Configuration Menu Modifications (Second-Level Configuration Menu)

To modify certain items in the Configuration Menu, the OI-7032 Terminal Board must be reset (while in the Configuration Menu). To reset the board, complete the following steps.

1. Press “Restart OI-7032”. The Touchscreen will show the following:

The screenshot shows a configuration menu for the OI-7032 terminal board. A pop-up window titled "OI-7032 no response" is displayed in the top left, with a yellow "Close" button. The background menu includes a "HOME" button in the top right, a "Date Manufactured: 02/11/2011" field, and a table of relay settings. The "Restart OI-7032" option is selected, leading to a confirmation dialog: "Reset OI-7032 to Factory Defaults?" with a "Yes" button. Below the menu is the OTIS INSTRUMENTS INC. logo and a row of buttons for "Relay 1", "Relay 2", "Relay 3", "Relay 4", "Fault", and "Reset".

00		Date Manufactured: 02/11/2011			
Address	1	Relay Settings			
Baud Rate	9600	Relay 1	Not Failsafe		
Enter Calibration Mode	Radio Settings	Radio Timeout (Minutes)	10	Relay 2	Not Failsafe
				Relay 3	Not Failsafe
Test Relays	GEN II Radio Settings	Network ID	5	Relay 4	Not Failsafe
		Secondary Monitor		Fault	Failsafe
Restart OI-7032	Reset OI-7032 to Factory Defaults?		Yes	Relay 4 is Fault Relay	No

OTIS
INSTRUMENTS INC.

Relay 1	Relay 2	Relay 3	Relay 4	Fault	Reset
---------	---------	---------	---------	-------	-------

2. Wait for the pop-up window to disappear and the grayed-out buttons to become black, then modify the options that are now available for changes (see the following sub-sections for specific instructions on how to modify items while in the Second-Level Configuration Menu).

NOTE: The OI-7032 will allow 30 seconds—starting from when the pop-up window disappears—to make any changes to the temporarily-enabled items.

NOTE: If additional time (beyond the 30 seconds) is needed, repeat the steps to reset the Terminal Board.

MODIFY Modbus Output Settings: Address

While in the Second-Level Configuration Menu, modify the address by touching the number next to the word “Address”. When the numeric keypad appears, type the desired address number and then press “ENT”.

NOTE: The acceptable values for this setting are 1-247. If a value that falls outside this range is entered, the previously entered value will be used.

Configuration

Monitor Serial # G65000		Date Manufactured: 02/11/2011	
Configuration Settings	Modbus Output Settings	Address 1	Relay Settings
		Baud Rate 9600	Relay 1 Not Failsafe
Enter Calibration Mode	Radio Settings	Radio Timeout (Minutes) 10	Relay 2 Not Failsafe
			Relay 3 Not Failsafe
Test Relays	GEN II Radio Settings	Network ID 5	Relay 4 Not Failsafe
		Secondary Monitor	Fault Failsafe
Restart OI-7032	Reset OI-7032 to Factory Defaults?	Yes	Relay 4 is Fault Relay No



Relay 1	Relay 2	Relay 3	Relay 4	Fault	Reset
---------	---------	---------	---------	-------	-------

MODIFY Modbus Output Settings: Baud Rate

While in the Second-Level Configuration Menu, modify the Baud Rate by pressing the arrow next to the current Baud Rate setting, and then choosing the desired option from the drop-down list.

Configuration HOME

Monitor Serial # G65000 Date Manufactured: 02/11/2011

Configuration Settings	Modbus Output Settings	Address	1	Relay Settings
		Baud Rate	9600	Relay 1 Not Failsafe
Enter Calibration Mode	Radio Settings	Radio Timeout (Minutes)	10	Relay 2 Not Failsafe
				Relay 3 Not Failsafe
Test Relays	GEN II Radio Settings	Network ID	5	Relay 4 Not Failsafe
			Secondary Monitor	Fault Failsafe
Restart OI-7032	Reset OI-7032 to Factory Defaults?	Yes		Relay 4 is Fault Relay No

Relay 1	Relay 2	Relay 3	Relay 4	Fault	Reset
---------	---------	---------	---------	-------	-------

MODIFY Radio Settings: Radio Timeout

While in the Second-Level Configuration Menu, adjust the Radio Timeout by touching the number next to “Radio Timeout (Minutes)”. When the numeric keypad appears, type the desired timeout time (in minutes) and then press “ENT”.

NOTE: The acceptable values for timeout is 6-255 minutes. If a value that falls outside of the range is entered, the previously entered value will be used.

Configuration HOME

Monitor Serial # G65000 Date Manufactured: 02/11/2011

Configuration Settings	Modbus Output Settings	Address	1	Relay Settings
		Baud Rate	9600	Relay 1 Not Failsafe
Enter Calibration Mode	Radio Settings	Radio Timeout (Minutes)	10	Relay 2 Not Failsafe
				Relay 3 Not Failsafe
Test Relays	GEN II Radio Settings	Network ID	5	Relay 4 Not Failsafe
			Secondary Monitor	Fault Failsafe
Restart OI-7032	Reset OI-7032 to Factory Defaults?	Yes		Relay 4 is Fault Relay No

Relay 1	Relay 2	Relay 3	Relay 4	Fault	Reset
---------	---------	---------	---------	-------	-------

MODIFY Gen II Radio Settings: Network ID

While in the Second-Level Configuration Menu, adjust the Network ID by touching the number under “Network ID”. When the numeric keypad appears, type the desired ID number and then press “ENT”.

NOTE: The values allowed for “Network ID” are 1-78. If a value that falls outside this range is entered, the previously entered value will be used.

NOTE: Setting the Network ID is only necessary when using a GenII radio.

Configuration				HOME	
Monitor Serial # G65000		Date Manufactured: 02/11/2011			
Configuration Settings	Modbus Output Settings	Address	1	Relay Settings	
		Baud Rate	9600	Relay 1	Not Failsafe
Enter Calibration Mode	Radio Settings	Radio Timeout (Minutes)	10	Relay 2	Not Failsafe
				Relay 3	Not Failsafe
Test Relays	GEN II Radio Settings	Network ID	5	Relay 4	Not Failsafe
			Secondary Monitor	Fault	Failsafe
Restart OI-7032	Reset OI-7032 to Factory Defaults?	Yes		Relay 4 is Fault Relay	No

Relay 1	Relay 2	Relay 3	Relay 4	Fault	Reset
---------	---------	---------	---------	-------	-------

MODIFY Gen II Radio Settings: Primary or Secondary Monitor

While in the Second-Level Configuration Menu, the monitor can be set as either a Primary or Secondary monitor by touching the “Primary/Secondary Monitor” button in the Gen II Radio Settings box.

Configuration				HOME	
Monitor Serial # G65000		Date Manufactured: 02/11/2011			
Configuration Settings	Modbus Output Settings	Address	1	Relay Settings	
		Baud Rate	9600	Relay 1	Not Failsafe
Enter Calibration Mode	Radio Settings	Radio Timeout (Minutes)	10	Relay 2	Not Failsafe
				Relay 3	Not Failsafe
Test Relays	GEN II Radio Settings	Network ID	5	Relay 4	Not Failsafe
			Secondary Monitor	Fault	Failsafe
Restart OI-7032	Reset OI-7032 to Factory Defaults?	Yes		Relay 4 is Fault Relay	No

Relay 1	Relay 2	Relay 3	Relay 4	Fault	Reset
---------	---------	---------	---------	-------	-------

MODIFY OI-7032 Reset to Factory Default

While in the Second-Level Configuration Menu, the user can reset the OI-7032 to the factory default settings by completing the following steps.

1. Press the “Yes” button in the “Reset OI-7032 to Factory Defaults?” box.

Configuration HOME

Monitor Serial # G65000 Date Manufactured: 02/11/2011

Configuration Settings	Modbus Output Settings	Address	1	Relay Settings
		Baud Rate	9600	Relay 1 Not Failsafe
Enter Calibration Mode	Radio Settings	Radio Timeout (Minutes)	10	Relay 2 Not Failsafe
				Relay 3 Not Failsafe
Test Relays	GEN II Radio Settings	Network ID	5	Relay 4 Not Failsafe
			Secondary Monitor	Fault Failsafe
Restart OI-7032	Reset OI-7032 to Factory Defaults?		Yes	Relay 4 is Fault Relay No

Relay 1	Relay 2	Relay 3	Relay 4	Fault	Reset
---------	---------	---------	---------	-------	-------

2. A pop-up will appear for action-confirmation. Press “Yes” to confirm, or “No” to decline.

MODIFY Relay Settings: Relays 1-4 (Failsafe)

While in the Second-Level Configuration Menu, set relays 1-4 to be failsafe (or not failsafe) by pressing the “Not Failsafe” (or “Failsafe”) button next to the desired relay in the Relay 1, 2, 3 or 4 box.

Configuration HOME

Monitor Serial # G65000 Date Manufactured: 02/11/2011

Configuration Settings	Modbus Output Settings	Address	1	Relay Settings
		Baud Rate	9600	Relay 1 Not Failsafe
Enter Calibration Mode	Radio Settings	Radio Timeout (Minutes)	10	Relay 2 Not Failsafe
				Relay 3 Not Failsafe
Test Relays	GEN II Radio Settings	Network ID	5	Relay 4 Not Failsafe
			Secondary Monitor	Fault Failsafe
Restart OI-7032	Reset OI-7032 to Factory Defaults?		Yes	Relay 4 is Fault Relay No

Relay 1	Relay 2	Relay 3	Relay 4	Fault	Reset
---------	---------	---------	---------	-------	-------

MODIFY Relay Settings: Fault Terminal

While in the Second-Level Configuration Menu, set the relays and fault terminal to be failsafe (or not failsafe) by pressing the “Failsafe” (or “Not Failsafe”) button in the Relay Settings box.

Configuration				HOME	
Monitor Serial # G65000		Date Manufactured: 02/11/2011			
Configuration Settings	Modbus Output Settings	Address	1	Relay Settings	
		Baud Rate	9600	Relay 1	Not Failsafe
Enter Calibration Mode	Radio Settings	Radio Timeout (Minutes)	10	Relay 2	Not Failsafe
				Relay 3	Not Failsafe
Test Relays	GEN II Radio Settings	Network ID	5	Relay 4	Not Failsafe
			Secondary Monitor	Fault	Failsafe
Restart OI-7032	Reset OI-7032 to Factory Defaults?	Yes		Relay 4 is Fault Relay	No

Relay 1	Relay 2	Relay 3	Relay 4	Fault	Reset
---------	---------	---------	---------	-------	-------

MODIFY Relay Settings: Fault Relay Assign

While in the Second-Level Configuration Menu, set relay 4 as the fault relay (or not the fault relay) by pressing the “Yes/No” button in the “Relay 4 is Fault Relay” box.

Configuration				HOME	
Monitor Serial # G65000		Date Manufactured: 02/11/2011			
Configuration Settings	Modbus Output Settings	Address	1	Relay Settings	
		Baud Rate	9600	Relay 1	Not Failsafe
Enter Calibration Mode	Radio Settings	Radio Timeout (Minutes)	10	Relay 2	Not Failsafe
				Relay 3	Not Failsafe
Test Relays	GEN II Radio Settings	Network ID	5	Relay 4	Not Failsafe
			Secondary Monitor	Fault	Failsafe
Restart OI-7032	Reset OI-7032 to Factory Defaults?	Yes		Relay 4 is Fault Relay	No

Relay 1	Relay 2	Relay 3	Relay 4	Fault	Reset
---------	---------	---------	---------	-------	-------

Relay Indicator

Indicators for all four relays remain along the bottom of the Touchscreen at all times. When a relay has been triggered, that relay indicator will turn red.

In the illustration below, all four relays are in alarm (in Relay Test Mode):

Configuration

🏠
HOME

Monitor Serial # G65000 Date Manufactured: 02/11/2011

Configuration Settings	Modbus Output Settings	Address	1	Relay Settings	
		Baud Rate	9600 ▼	Relay 1	Not Failsafe
Enter Calibration Mode	Radio Settings	Radio Timeout (Minutes)	10	Relay 2	Not Failsafe
				Relay 3	Not Failsafe
Testing Relays	GEN II Radio Settings	Network ID	5	Secondary Monitor	Relay 4
					Not Failsafe
				Fault	Failsafe
Restart OI-7032	Reset OI-7032 to Factory Defaults?		Yes	Relay 4 is Fault Relay	No



Relay 1	Relay 2	Relay 3	Relay 4	Fault	Reset
---------	---------	---------	---------	-------	-------

Fault Indicator

A button for fault indication remains along the bottom of the Touchscreen at all times. When a fault occurs, the fault button will turn orange.

Channel 29 Configuration



Channel On	Relay 1 On	Relay 2 On	Relay 3 On	Relay 4 On
	Alarm On Rising	Alarm On Rising	Alarm On Rising	Alarm On Rising
Wirefree	Unlatching	Unlatching	Unlatching	Unlatching
Relay Values	10.000	15.000	20.000	25.000

Scale				Sensor Location <u>Flarestack</u>		Duplicate Settings	
Relay 1	Relay 2	Relay 3	Relay 4	Fault	Reset		

Fault Status

To view the Fault Status, press the “Fault” button. The screen will show orange buttons for the channels that are in fault, as well as a description of the fault. The following illustration shows the Fault Status screen (without any faults):

Fault Status



Channel State	Fault	Channel State	Fault	Channel State	Fault	Channel State	Fault
Channel 1 On	No Faults	Channel 9 On	No Faults	Channel 17 On	No Faults	Channel 25 On	No Faults
Channel 2 On	No Faults	Channel 10 On	No Faults	Channel 18 On	No Faults	Channel 26 On	No Faults
Channel 3 On	No Faults	Channel 11 On	No Faults	Channel 19 On	No Faults	Channel 27 On	No Faults
Channel 4 On	No Faults	Channel 12 On	No Faults	Channel 20 On	No Faults	Channel 28 On	No Faults
Channel 5 On	No Faults	Channel 13 On	No Faults	Channel 21 On	No Faults	Channel 29 On	No Faults
Channel 6 On	No Faults	Channel 14 On	No Faults	Channel 22 On	No Faults	Channel 30 On	No Faults
Channel 7 On	No Faults	Channel 15 On	No Faults	Channel 23 On	No Faults	Channel 31 On	No Faults
Channel 8 On	No Faults	Channel 16 On	No Faults	Channel 24 On	No Faults	Channel 32 On	No Faults

Relay 1	Relay 2	Relay 3	Relay 4	Fault	Reset
---------	---------	---------	---------	-------	-------

Channel On Without Wired Sensor Connected (Fault)

Fault Status



Channel State	Fault	Channel State	Fault	Channel State	Fault	Channel State	Fault
Channel 1 On	No Faults	Channel 9 On	No Faults	Channel 17 On	No Faults	Channel 25 On	No Faults
Channel 2 On	No Faults	Channel 10 On	No Faults	Channel 18 On	No Faults	Channel 26 On	No Faults
Channel 3 On	No Faults	Channel 11 On	No Faults	Channel 19 On	No Faults	Channel 27 On	No Faults
Channel 4 On	No Faults	Channel 12 On	No Faults	Channel 20 On	No Faults	Channel 28 On	No Faults
Channel 5 On	No Faults	Channel 13 On	No Faults	Channel 21 On	No Faults	Channel 29 On	Wired Sensor Not Connected
Channel 6 On	No Faults	Channel 14 On	No Faults	Channel 22 On	No Faults	Channel 30 On	Wired Sensor Not Connected
Channel 7 On	No Faults	Channel 15 On	No Faults	Channel 23 On	No Faults	Channel 31 On	Wired Sensor Not Connected
Channel 8 On	No Faults	Channel 16 On	No Faults	Channel 24 On	No Faults	Channel 32 On	Wired Sensor Not Connected

Relay 1	Relay 2	Relay 3	Relay 4	Fault	Reset
---------	---------	---------	---------	-------	-------

F1: Check Sensor Cable

Fault Status



Channel State	Fault	Channel State	Fault	Channel State	Fault	Channel State	Fault
Channel 1 On	F1: Check Sensor Cable	Channel 9 Off	No Faults	Channel 17 Off	No Faults	Channel 25 Off	No Faults
Channel 2 Off	No Faults	Channel 10 Off	No Faults	Channel 18 Off	No Faults	Channel 26 Off	No Faults
Channel 3 Off	No Faults	Channel 11 Off	No Faults	Channel 19 Off	No Faults	Channel 27 Off	No Faults
Channel 4 Off	No Faults	Channel 12 Off	No Faults	Channel 20 Off	No Faults	Channel 28 Off	No Faults
Channel 5 Off	No Faults	Channel 13 Off	No Faults	Channel 21 Off	No Faults	Channel 29 Off	No Faults
Channel 6 Off	No Faults	Channel 14 Off	No Faults	Channel 22 Off	No Faults	Channel 30 Off	No Faults
Channel 7 Off	No Faults	Channel 15 Off	No Faults	Channel 23 Off	No Faults	Channel 31 Off	No Faults
Channel 8 Off	No Faults	Channel 16 Off	No Faults	Channel 24 Off	No Faults	Channel 32 Off	No Faults

Relay 1	Relay 2	Relay 3	Relay 4	Fault	Reset
---------	---------	---------	---------	-------	-------

F4: Check Sensor Board

Fault Status



Channel State	Fault	Channel State	Fault	Channel State	Fault	Channel State	Fault
Channel 1 On	F4: Check Sensor Board	Channel 9 Off	No Faults	Channel 17 Off	No Faults	Channel 25 Off	No Faults
Channel 2 Off	No Faults	Channel 10 Off	No Faults	Channel 18 Off	No Faults	Channel 26 Off	No Faults
Channel 3 Off	No Faults	Channel 11 Off	No Faults	Channel 19 Off	No Faults	Channel 27 Off	No Faults
Channel 4 Off	No Faults	Channel 12 Off	No Faults	Channel 20 Off	No Faults	Channel 28 Off	No Faults
Channel 5 Off	No Faults	Channel 13 Off	No Faults	Channel 21 Off	No Faults	Channel 29 Off	No Faults
Channel 6 Off	No Faults	Channel 14 Off	No Faults	Channel 22 Off	No Faults	Channel 30 Off	No Faults
Channel 7 Off	No Faults	Channel 15 Off	No Faults	Channel 23 Off	No Faults	Channel 31 Off	No Faults
Channel 8 Off	No Faults	Channel 16 Off	No Faults	Channel 24 Off	No Faults	Channel 32 Off	No Faults

Relay 1	Relay 2	Relay 3	Relay 4	Fault	Reset
---------	---------	---------	---------	-------	-------

Error Messages

The following section contains explanations, and corresponding illustrations, for error messages that may appear while using the OI-7032.

Double-Primary Error

Problem: There are two primary monitors in the network, which is not allowed.

NOTE: The Primary/Secondary setting ONLY applies to a GEN II network.

Reason 1: The OI-7032 was setup to be the primary monitor and it was turned off or reset, the secondary monitor became the primary monitor.

Reason 2: There was already a primary monitor setup when the OI-7032 was turned on, which conflicts with the OI-7032's default primary setting.

Solution: Set one of the monitors to be a primary and the other to be a secondary, or turn off the other monitor. To change the setting of the OI-7032, simply press the button beside "Make This Monitor:" (as illustrated below) to either "Primary" or "Secondary". Once the condition is resolved, the Home Screen will appear.

NOTE: It may take a few seconds for the change to be recognized before the Home Screen appears.



THERE IS ANOTHER
PRIMARY MONITOR

YOU CAN WAIT OR
CHANGE THIS ONE

Make This Monitor:			Primary		
Relay 1	Relay 2	Relay 3	Relay 4	Fault	Reset

Autoscroll Error

Problem: Autoscroll is turned on, but all channels are turned off.

Solution: Return to the Home Screen and activate all channels that are needed.



OI-7032 Generation II Monitor

**ALL CHANNELS TURNED OFF
PLEASE RETURN TO THE
HOME SCREEN AND ACTIVATE
NEEDED CHANNELS**



Relay 1

Relay 2

Relay 3

Relay 4

Fault

Reset

APPENDIX A: Software Installation

Installation

This section will detail how to set up the OI-7032 software.

HMI Software

1. Insert the provided CD into the CDROM drive of a computer. The following screen should automatically appear:

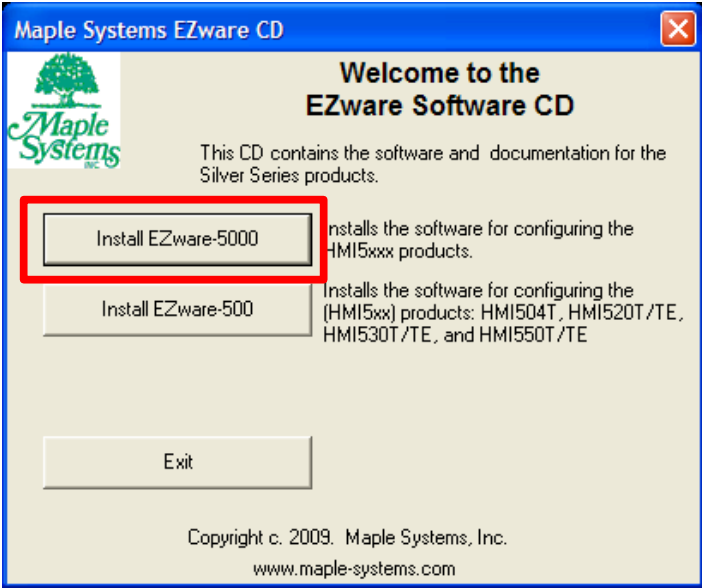

2. Select the top button “Install Ezware-5000”. The following window will appear:

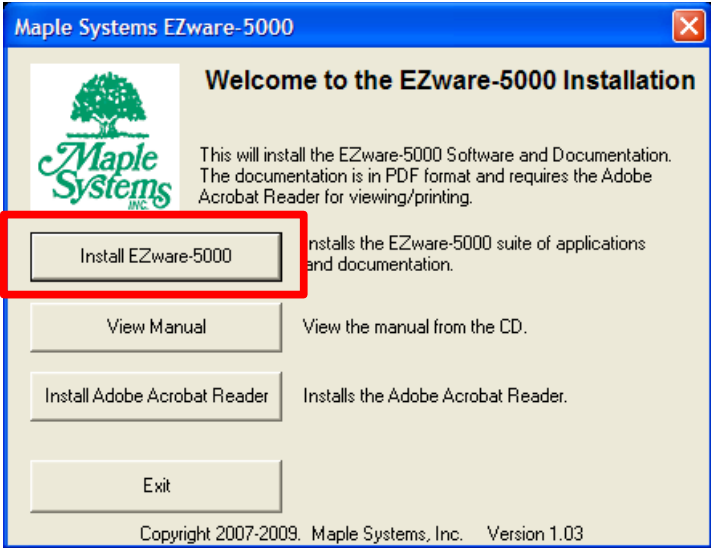

3. Select the top option again. The following notification will appear:

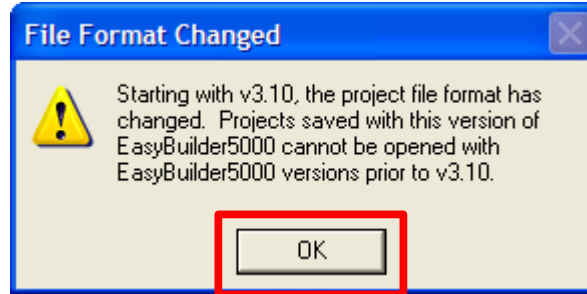

4. Press OK.

5. On the following screen, press "Next".

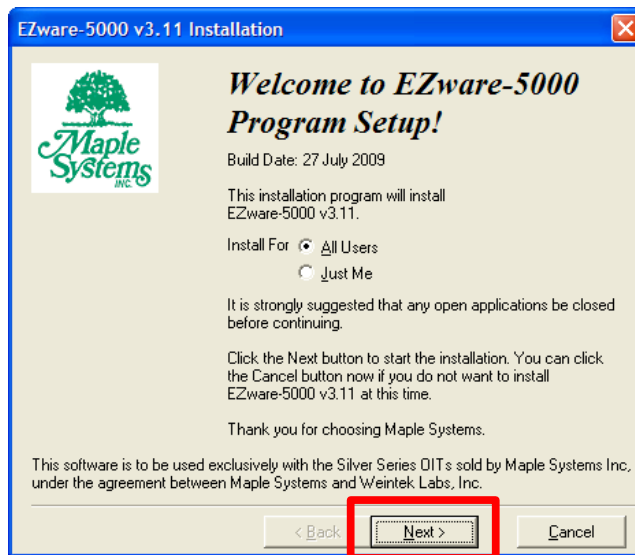

6. Press "Next" again.

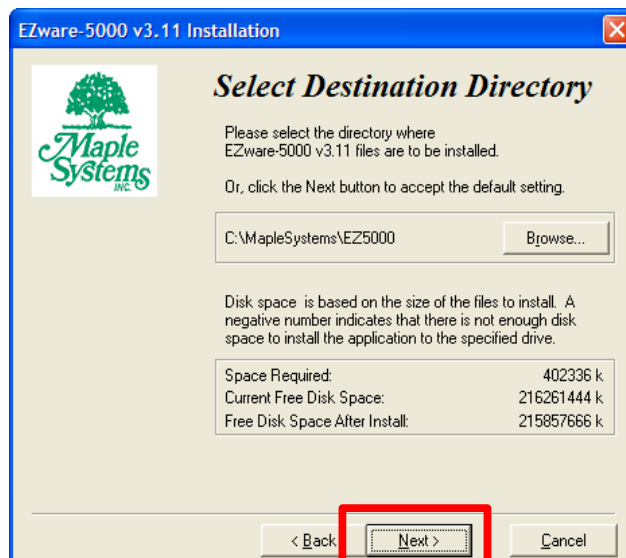

7. Press “Next” again.

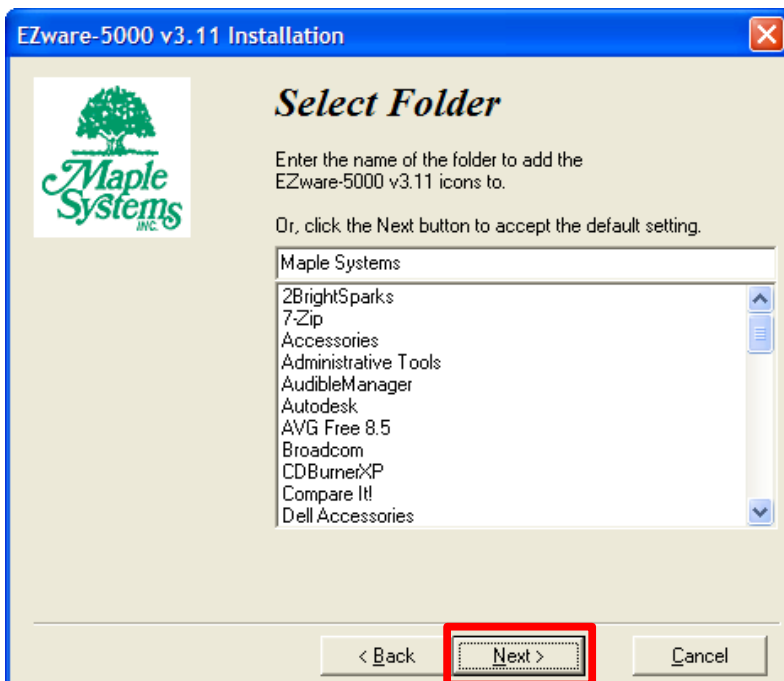

8. Press “Next” again to begin installation.

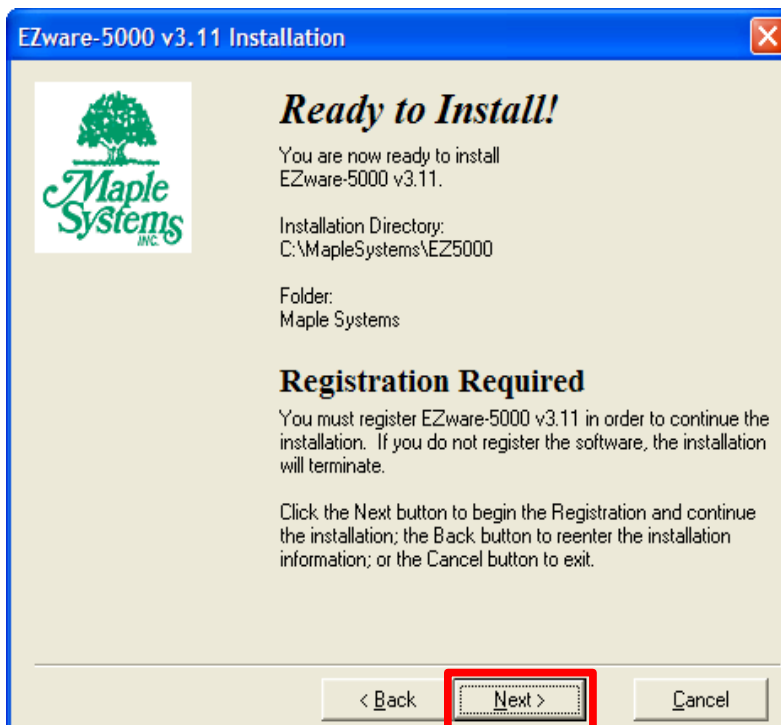

9. After the installation is complete, the following window will appear:

The image shows a registration window titled "Register Maple Systems' EZware-5000". The window has a blue header and a light beige background. The main text reads "Please register your software. Registration entitles you to Free technical support." Below this, there are three sections: "Contact Information (Required)", "Software Information (Required)", and "Optional".

Contact Information (Required)

Full Name
Company Name
Address
Address2
City
State/Province Zip/Postal Code
Country USA Email Address
Phone Fax
 Keep me informed about important software and product updates.

Software Information (Required)

Software EZware-5000 Version 3.11
Serial Number ? Purchased From

Optional

Please tell us a little about your application. You may use up to 250 characters.

At the bottom, there is a button with a question mark, a button that says "Maple Systems Respects Your Privacy!", and three buttons: "Register via Internet", "Cancel", and "Print Faxable Form".

10. Fill in the appropriate fields. The serial number can be found on the back of the plastic case that contained the CD. If a viable Internet connection is available, press the "Register via Internet" button now. If a viable Internet connection is not available, press "Print Faxable Form" and follow the subsequent instructions.

APPENDIX B: Reading USB Drive

USB Drive

The following instructions will advise the user on how to remove and read the USB Drive information.

Removing the USB Drive

1. Remove the USB drive from the OI-7032.
2. Plug the USB drive into your computer.

Reading the USB Drive

When looking at the contents of the USB drive, you will see the following:

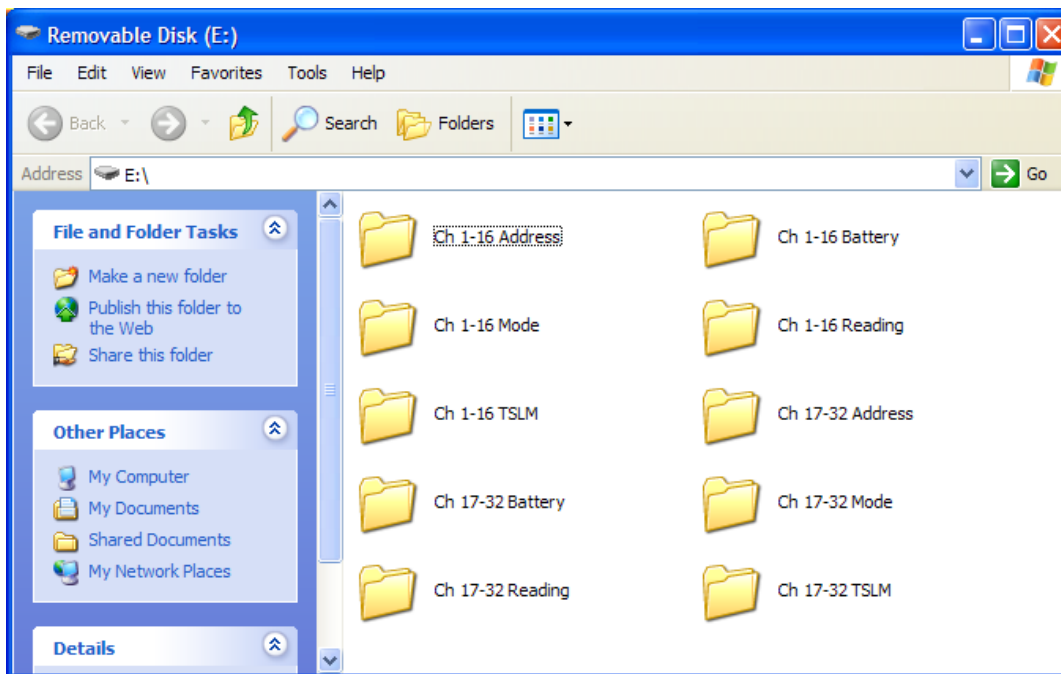

Opening the Datalog Files

Each folder is labeled. Inside each folder, there is a datalog file for each day. In order to open the datalog files, you must first convert them with the “Easy Converter” software that was installed with the CD provided.

Opening the Easy Converter Software

In order to open this software, complete the following.

1. Click on your Start Menu.
2. Click on “All Programs”.
3. Locate the folder labeled “Maple Systems”.

4. Open the folder within labeled “Ezware-5000”.
5. Open the shortcut called “Easy Converter”.
6. Once Easy Converter is opened, click the “open” button to locate the datalog file desired to convert.

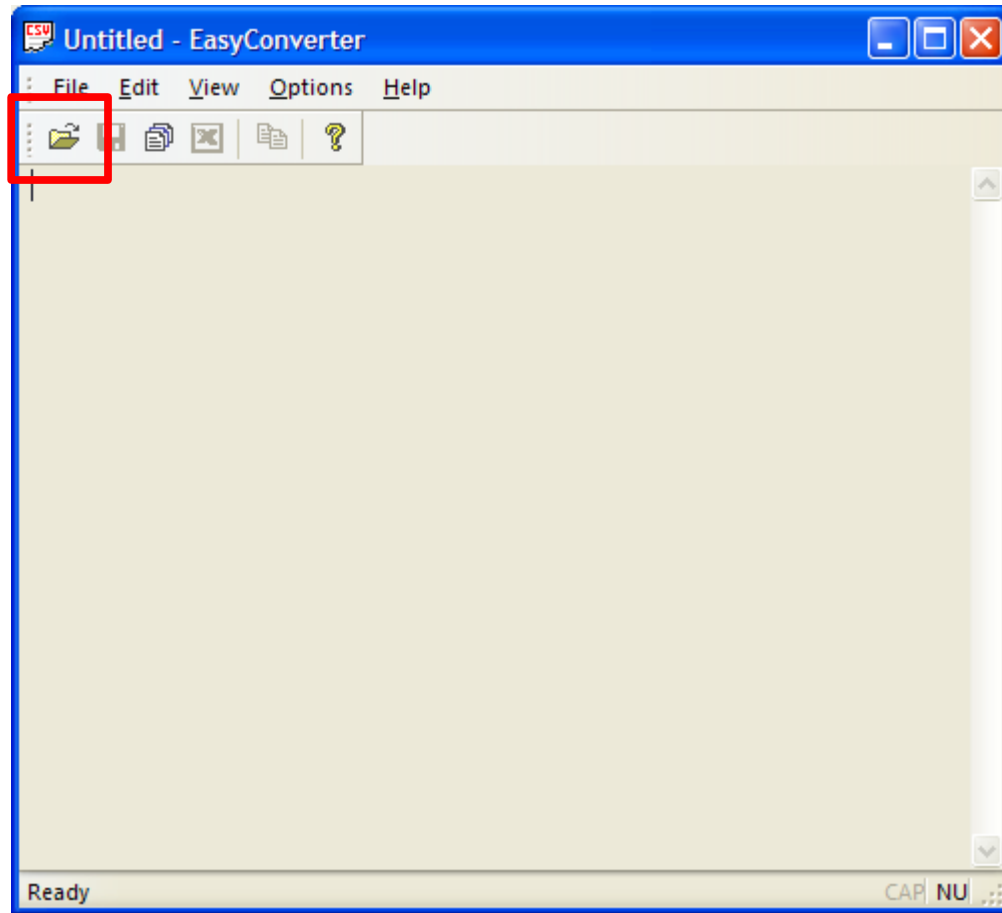

7. Once the file has been selected and “OK” is pressed, the following window will appear:

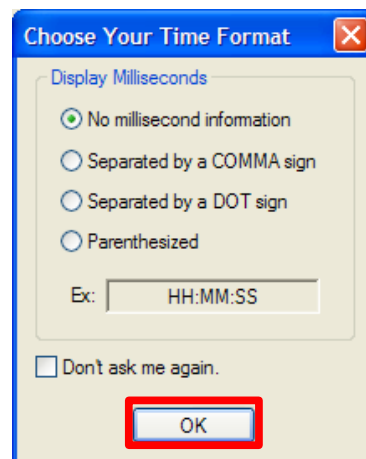

8. Press "OK" to proceed to the next window.
9. Press "OK" again.

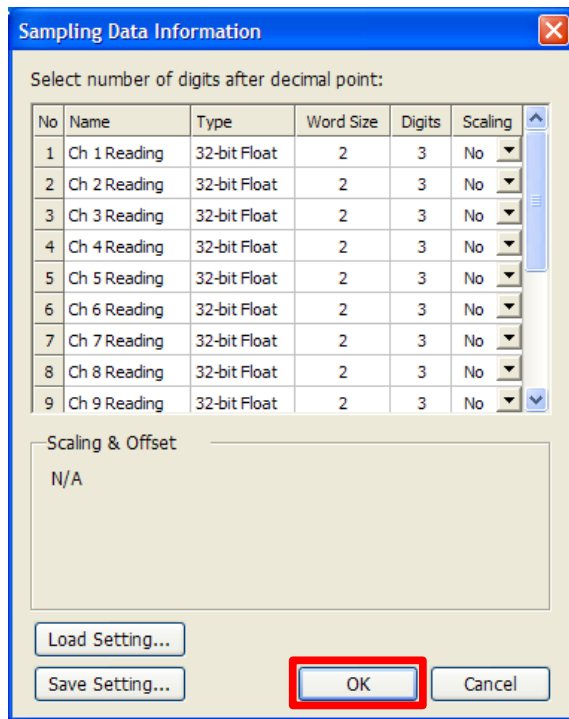

10. The following window will appear. The data may then be converted into an .xls (spreadsheet file).

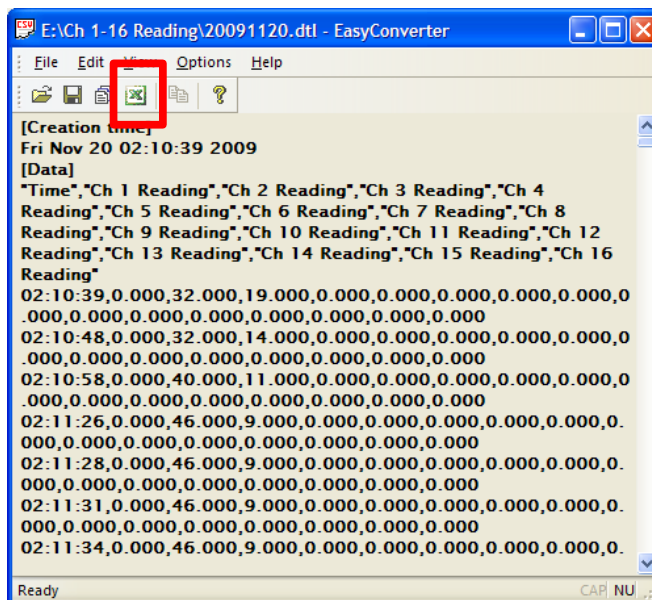

Converting the Datalog File to an .xls (spreadsheet) File

In order to convert the file to an .xls or spreadsheet file, complete the following instructions.

1. Press the “spreadsheet” button as seen in the diagram above.
2. The software will convert the file and save it in the same location as the datalog file. To view the file, complete the instructions in the following section.

Viewing the Datalog File

To view the file, open the folder on the USB drive that contains the datalog file.

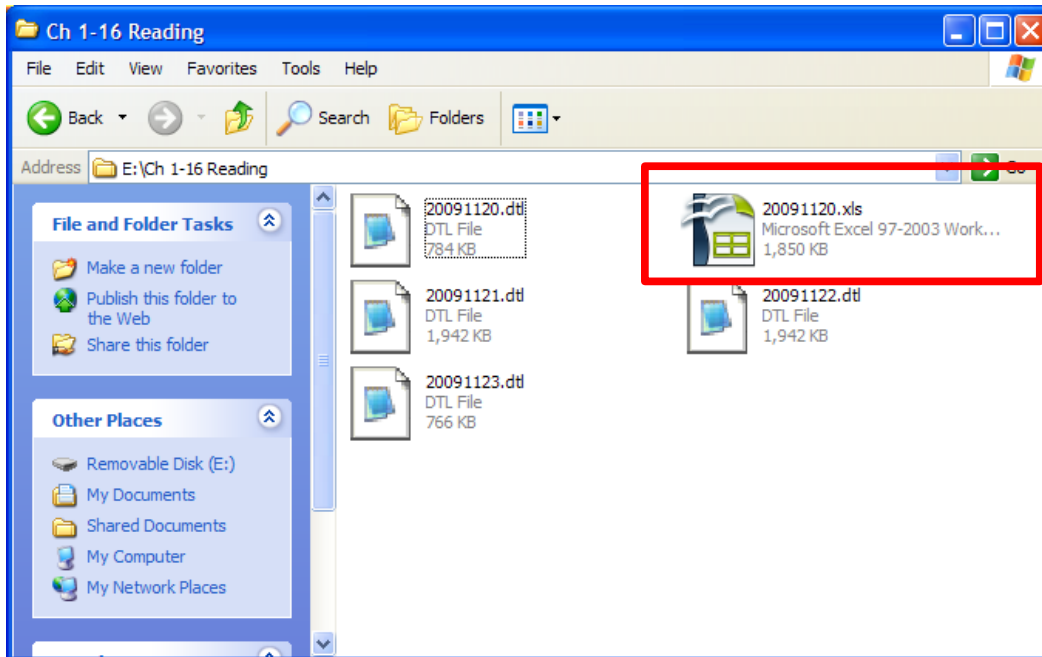

The data can be viewed in Microsoft Excel or any other compatible spreadsheet software.

When Finished Reading the USB Drive

When finished viewing the USB drive, complete the following instructions.

1. Insert the USB drive back into the OI-7032 Touchscreen. This should be done in the same manner as the removal was done.
2. On the screen that appears on the OI-7032, press “cancel”.
3. The OI-7032 will now resume saving the datalog files to the USB drive.

APPENDIX C: 4-20mA Loop Current Introduction

4-20mA Current Loop Introduction

This appendix is only an introduction. The information should serve as a brief overview of 4-20mA, and should not be considered a complete reference for proper implementation or use.

Prior knowledge of industry standards pertaining to 4-20mA specifically, and other aspects of electronics, are assumed to be known by the technician. For proper connection to a monitor or PLC, refer to the manufacturer's specific manual or instructions for that particular piece of hardware.

Overview

4-20mA ("four to twenty"), is an analog electrical transmission standard used by Otis Instruments for some of its ambient gas sensors and monitors. The signal is a current loop where 4mA represents zero percent signal, and 20mA represents 100 percent signal (full scale of the sensor assembly). The relationship between the current loop and the gas value is linear.

The 4mA allows the receiving monitor/PLC to distinguish between a zero signal, a broken wire, or a dead instrument. Benefits of 4-20mA convention are that it is: an industry standard, low-cost to implement, can reject some forms of electrical noise, and the signal does not change value around the "loop" (as apposed to a voltage). Only one current level can be present at any time; each device which operates via 4-20mA must to wired directly to the monitoring device.

Calculations

$$I_{(4-20)} = \left(\frac{16 \cdot \text{value}}{\text{scale}} \right) + 4$$

- $I_{(4-20)}$: current of loop, measured in mA
- value : PPM or %, of gas concentration
- scale : full scale of sensor (see below for usual ranges)

Target Gas	Range	Temp.
H2S = Hydrogen Sulphide	0-100 ppm	-20 to 50C
O2 = Oxygen	0-25 %	-30 to 55C
SO2 = Sulfur Dioxide	0-20 ppm	-20 to 50C
CL2 = Chlorine	0-10 ppm	-20 to 50C
H2 = Hydrogen	0-4 %	-20 to 40C
NH3 = Ammonia	0-100 ppm	-40 to 40C
CO = Carbon Monoxide	0-999 ppm	-20 to 50C
F2 = Florine	0-1 ppm	-10 to 40C
HF = Hydrogen Fluoride	0-10 ppm	-10 to 40C
H2S-2 = Hydrogen Sulphide (extended temp)	0-100 ppm	-40 to 50C

Table – Gas Sensor Details

Actual ranges may vary with our product. If unsure, confirm with the actual gas sensor assembly distributor, Otis Instruments sales representative, or call the main Otis Instruments office for more details.

Measuring Current

If the value measured is 0mA, then: the loop wires are broken, the sensor assembly is not powered up, the sensor assembly is malfunctioning, or the monitor is malfunctioning. A DMM (digital multi meter) or Current Meter may be used to test a 4-20mA signal. Place the DMM or Current Meter in line with the loop and measure current. The DMM/Current Meter may be used in conjunction with the normal monitoring device.

Specifications

Operating Voltage:	24 Volts DC (nominal; 22-26 Volts DC), 120/240 Volts AC
Compatibility:	Otis WireFree and wired (4-20mA input) sensor units
Channels:	32
Gases:	all that are supported by the sensor assemblies
Wired Output:	RS-485 Modbus
Relays:	four Dry-Contact (5 Amp) w/ 4 Amp Fuses
Protection:	power EMI filter, surge suppression, 4-20mA and RS-485 surge suppression
Current Draw:	300mA (typical, no wired sensor assemblies) 3A max (with 4-20mA input sensor assemblies)
Radio Options:	<ul style="list-style-type: none">· 900 MHz (Legacy Option), 100mW· 2.4 GHz ISM, 100mW· 900 MHz, 200mW
Display:	7.0 Inch 800x480 pixels resistive touchscreen
Temperature Range:	-20 to 122 degrees F
Enclosure:	Stahlin 12x10x6 fiberglass, clear window
Certifications:	NEMA 4 (enclosure only)
Warranty:	Hardware: 1 year (limited)

Warranty Statement for **WireFree Touchscreen Monitor OI-7032**

Hardware

Otis Instruments, Inc. (Manufacturer) warrants its products to be free of defects in workmanship and materials—under normal use and service—from the date of purchase from the manufacturer or from the product's authorized reseller. The hardware for this device is under a one-year limited warranty.

The manufacturer is not liable (under this warranty) if its testing and examination disclose that the alleged defect in the product does not exist or was caused by the purchaser's (or any third party's) misuse, neglect, or improper installation, testing or calibrations. Any unauthorized attempt to repair or modify the product, or any other cause of damage beyond the range of the intended use, including damage by fire, lightning, water damage or other hazard, voids liability of the manufacturer.

In the event that a product should fail to perform up to manufacturer specifications during the applicable warranty period, contact the product's authorized reseller or return the product directly to the manufacturer with a Return Material Authorization (RMA). This number will be assigned upon contacting customer service at 979.776.7700 or Otis@otisinstruments.com. The manufacturer will--at its option and expense--repair or replace the product, or deliver an equivalent product or part to the purchaser at no additional charge.

Any replaced or repaired product or part has either a 90-day warranty or the remainder of the initial warranty period (whichever is longer).



Otis Instruments, Inc.

Corporate Office
2200 E. Villa Maria Dr.
Bryan, TX 77802
979.776.7700
www.otisinstruments.com