

GEN<sup>2</sup>

Model OI-7543  
*WireFree Receiver*

Operation Manual

*Revision 2.0.1w*



# Product Overview

The GenII OI-7543 is a WireFree 4-channel receiver specifically designed for use in conjunction with Otis Instruments, Inc. GenII WireFree Sensor Assemblies.

The OI-7543 feature 3 relays, and can monitor up to four sensors. The ability to mount the device near the entrance of a site allows the technician to immediately determine if it is safe to enter the site, making this device incredibly useful in any environment hosting hazardous gas. The OI-7543 can be mounted as a traditional or self-contained system that requires 12-24 Volts DC or 120/240 Volts AC. The OI-7543 receives transmissions from WireFree sensors via an on-board 900MHz (expected release 2011) or 2.4GHz GenII radio.

---

## Table of Contents

<b>Product Overview</b> .....	<b>2</b>
<b>Introduction</b> .....	<b>3</b>
<b>Warnings</b> .....	<b>3</b>
<b>Recommendations</b> .....	<b>3</b>
<b>Complete System Diagrams</b> .....	<b>4</b>
<i>Complete System</i> .....	<i>4</i>
<i>Control Board</i> .....	<i>4</i>
<b>Power On</b> .....	<b>5</b>
<b>Power Off</b> .....	<b>6</b>
<b>Basic Configuration Menu: Individual Channel Setup</b> .....	<b>6</b>
<i>Channel Selection</i> .....	<i>6</i>
<i>Channel On/Off</i> .....	<i>7</i>
<i>Radio Address Setting</i> .....	<i>7</i>
<i>Relay On/Off</i> .....	<i>7</i>
<i>Relay Setting-Type (Rise/Fall)</i> .....	<i>8</i>
<i>Relay Value Setting</i> .....	<i>8</i>
<i>Relay Latching/Unlatching</i> .....	<i>8</i>
<i>Duplicate Channel</i> .....	<i>9</i>
<b>Advanced Configuration Menu (Global Settings)</b> .....	<b>9</b>
<i>Entering Advanced Configuration Menu</i> .....	<i>9</i>
<i>Adjusting LCD Contrast</i> .....	<i>9</i>
<i>Restore Factory Default Settings</i> .....	<i>10</i>
<i>Fault Relay Setup: Relay 3 Fault Relay</i> .....	<i>10</i>
<i>Fault Relay Setup: Latching or Unlatching</i> .....	<i>10</i>
<i>Relay Failsafe Setup: Relay 1 Failsafe (right)</i> .....	<i>11</i>
<i>Relay Failsafe Setup: Relay 2 Failsafe (below)</i> .....	<i>11</i>
<i>Relay Failsafe Setup: Relay 3 Failsafe (right)</i> .....	<i>11</i>
<i>Relay Failsafe Setup: Fault Terminal Failsafe (below)</i> .....	<i>11</i>
<i>Radio Timeout Setting</i> .....	<i>12</i>
<i>Network Channel Setting</i> .....	<i>12</i>
<i>Primary/Secondary Setting</i> .....	<i>12</i>
<b>Relay/Alarm Tests</b> .....	<b>13</b>
<i>Relay 1 (Low Alarm) Test</i> .....	<i>13</i>
<i>Relay 2 (High Alarm) Test</i> .....	<i>13</i>
<i>Relay 3 (Danger Alarm) Test</i> .....	<i>13</i>
<b>Antenna Replacement</b> .....	<b>14</b>
<b>APPENDIX A: AC Wiring Configurations</b> .....	<b>15</b>
<i>AC Power Supply Wiring Configurations</i> .....	<i>15</i>
<i>Relay 1 (Low Alarm) Wiring Configurations</i> .....	<i>16</i>
<i>Relay 2 (High Alarm)Wiring Configurations</i> .....	<i>18</i>
<i>Relay 3 (Danger Alarm) Wiring Configurations</i> .....	<i>19</i>
<b>APPENDIX B: DC Wiring Configurations</b> .....	<b>20</b>
<i>DC Power Supply Wiring Configurations</i> .....	<i>20</i>
<i>Relay 1 (Low Alarm) Wiring Configurations</i> .....	<i>21</i>
<i>Relay 2 (High Alarm) Wiring Configurations</i> .....	<i>23</i>
<i>Relay 3 (Danger) Wiring Configurations</i> .....	<i>24</i>
<b>APPENDIX C: OI-7543 Troubleshooting Guide</b> .....	<b>25</b>
<b>Specifications</b> .....	<b>27</b>

## Introduction

This document is an Operation Manual containing diagrams and step-by-step instruction for proper operation of the Otis Instruments, Inc. GenII WireFree OI-7543. This document should be read before initial operation of the product.

Should a question arise during the use of the product, this document will serve as a first reference for consultation. If further questions arise, or if the device is not working properly, please contact the sales representative of this product.

## Warnings

- ◆ To ensure technician safety, always wire the relays before supplying power to the device.
- ◆ Do not open the enclosure if an explosive gas atmosphere may be present.

## Recommendations

For optimal performance, the manufacturer recommends using a minimum of 22 gauge wire for all Wiring Configurations.

Different loads require different gauge wire. Use the appropriate wire size—depending on the voltage and current requirements.

---

# Complete System Diagrams

The following diagrams should be consulted for identification of the system and all parts that may be referred to in this Operation Manual.

## Complete System

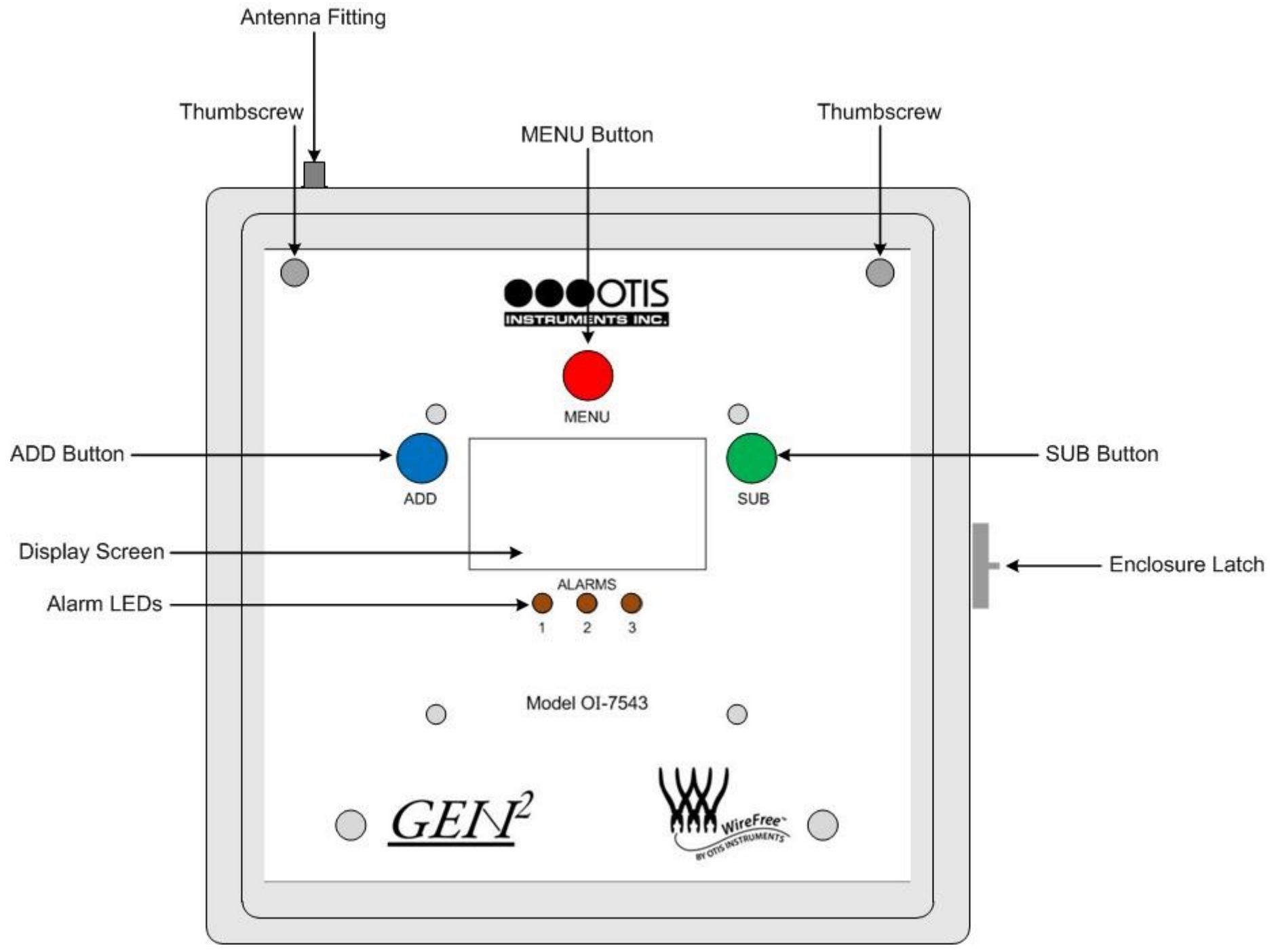

## Control Board

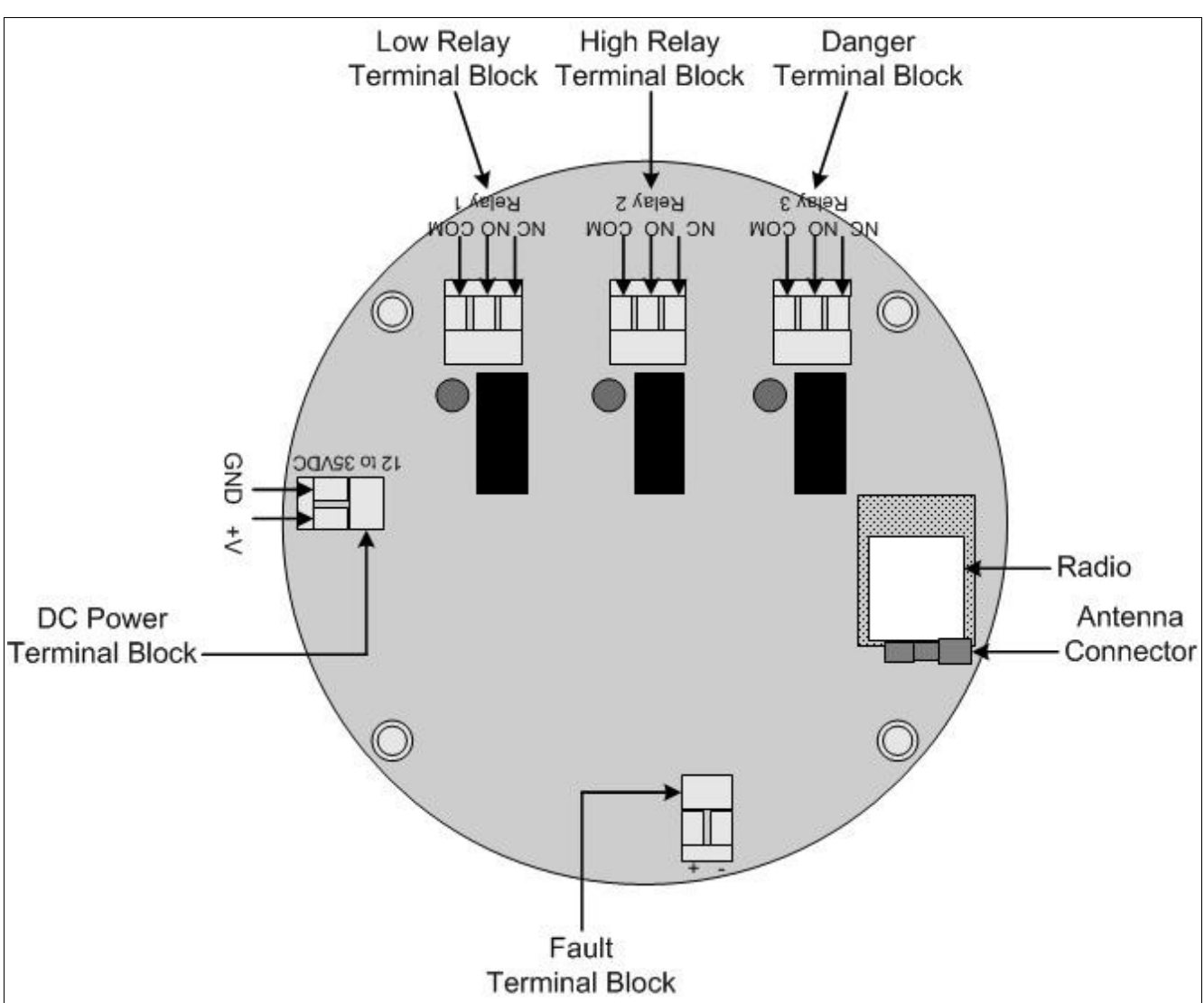

## Power On

Powering on the device activates its functions. When powered on, the device is fully functional and access to system and settings menus is allowed.

1. The OI-7543 will automatically Power On when the Power Wiring Configurations are complete and voltage is supplied to the unit.
2. The device will then count down from 10 to 0.
  - From 10 to 5, the Display Screen will show the Otis Instruments, Inc. logo.
  - From 5 to 0, the Display Screen should resemble the following illustration:

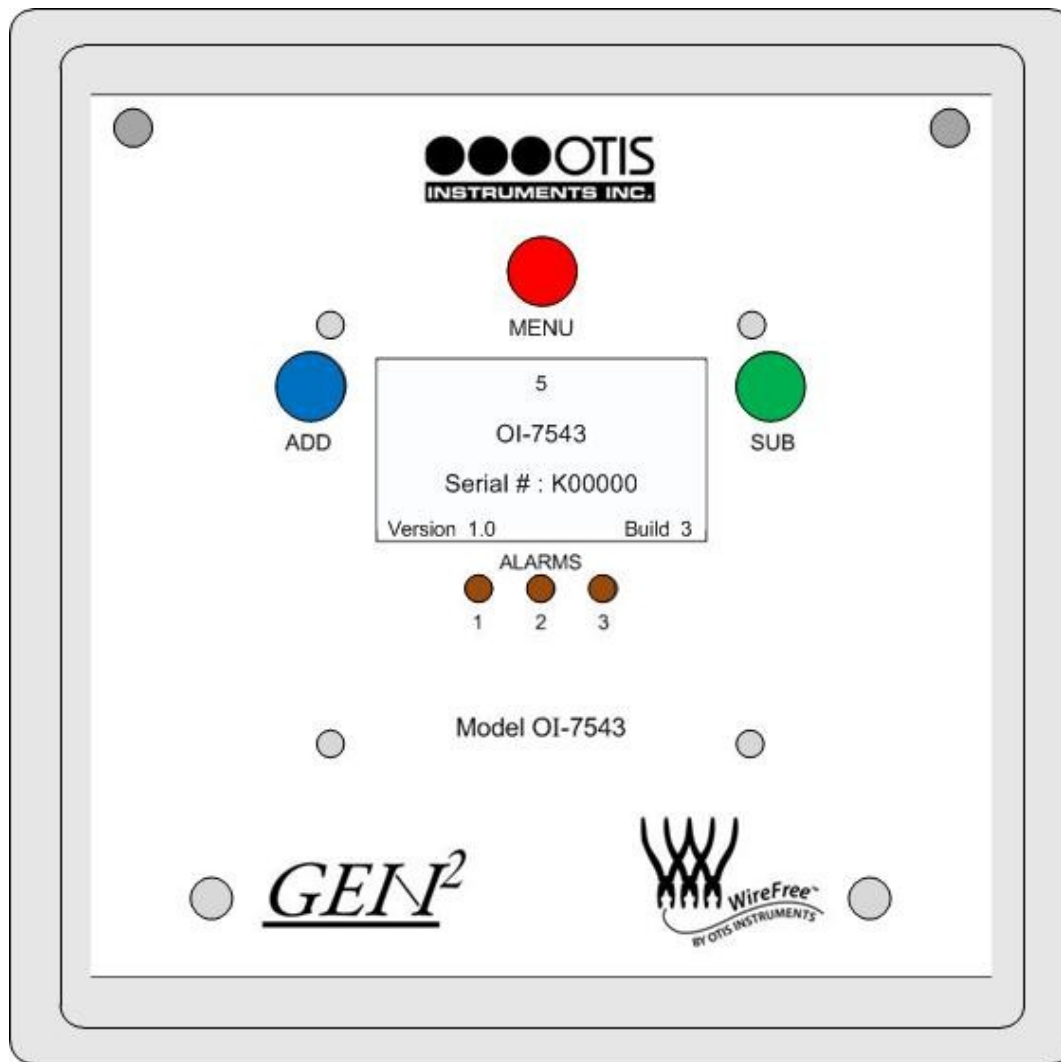

3. When the channel number is displayed, the device is in Normal Operating Mode and ready to operate. When in Normal Operating Mode, the display screen should resemble the following illustration:

*NOTE: If a channel is in Fault, the display screen will show F(#).*

*NOTE: If the relays for a channel are active, the display screen will show "1", "2", or "3" for the corresponding active relay; the corresponding active LED will also be illuminated.*

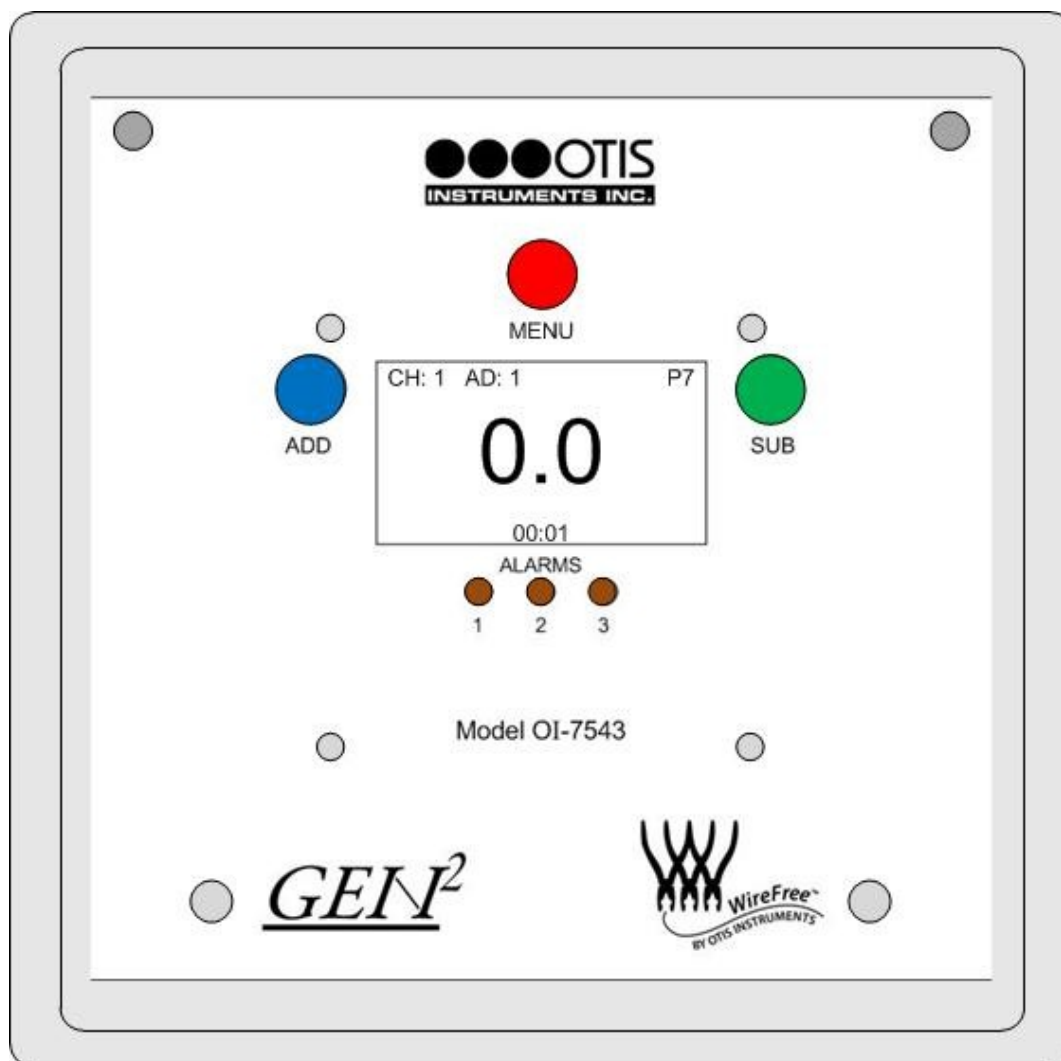

## Power Off

Powering off the device shuts down the system. When powered off, the device will no longer receive radio signals from the sensors.

The OI-7543 power is controlled by either an AC or DC power source; the OI-7543 will automatically Power Off when voltage is no longer supplied to the unit —by either turning off the voltage supply at the power source (DC power), or by unplugging the unit (AC power).

## Basic Configuration Menu: Individual Channel Setup

This feature should be used to setup all channels (and their corresponding relays). The Basic Configuration Menu includes: Channel Selection, Channel On/Off, Radio Address Setting, Relay On/Off, Relay Setting Type (Rise/Fall), Relay Value, and Relay Latching/Unlatching for each of the channels (and each of the 3 relays per channel) that the device will be monitoring (up to four). A Duplicate Channel feature is available at the end of each channel setup sequence; choosing “Yes” for the Duplicate Channel feature will duplicate all channels *after* the one that was just setup.

Each channel must be setup individually for each sensor. Therefore, Individual Channel Setup must be completed the same number of times that there are sensors being monitored.

*NOTE: To exit the Basic Configuration Menu at any time, touch ADD/SUB until you reach the Information Screen then hit MENU*

## Channel Selection

1. Open the enclosure door.
2. Press and hold *MENU* for five seconds.

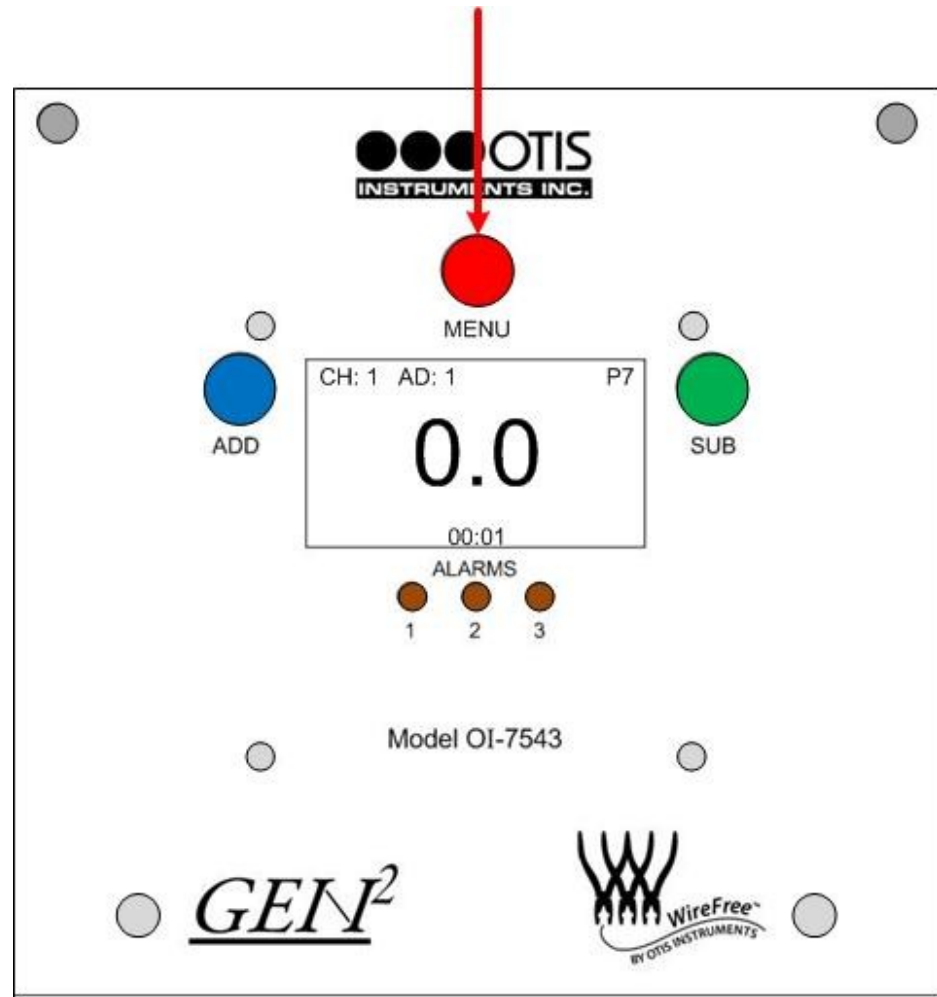

3. The display screen should resemble this illustration (right):
4. Touch *ADD* (increase) or *SUB* (decrease) to manipulate the Channel Selection setting (1-4).
5. Once the channel has been selected, proceed to the next step.

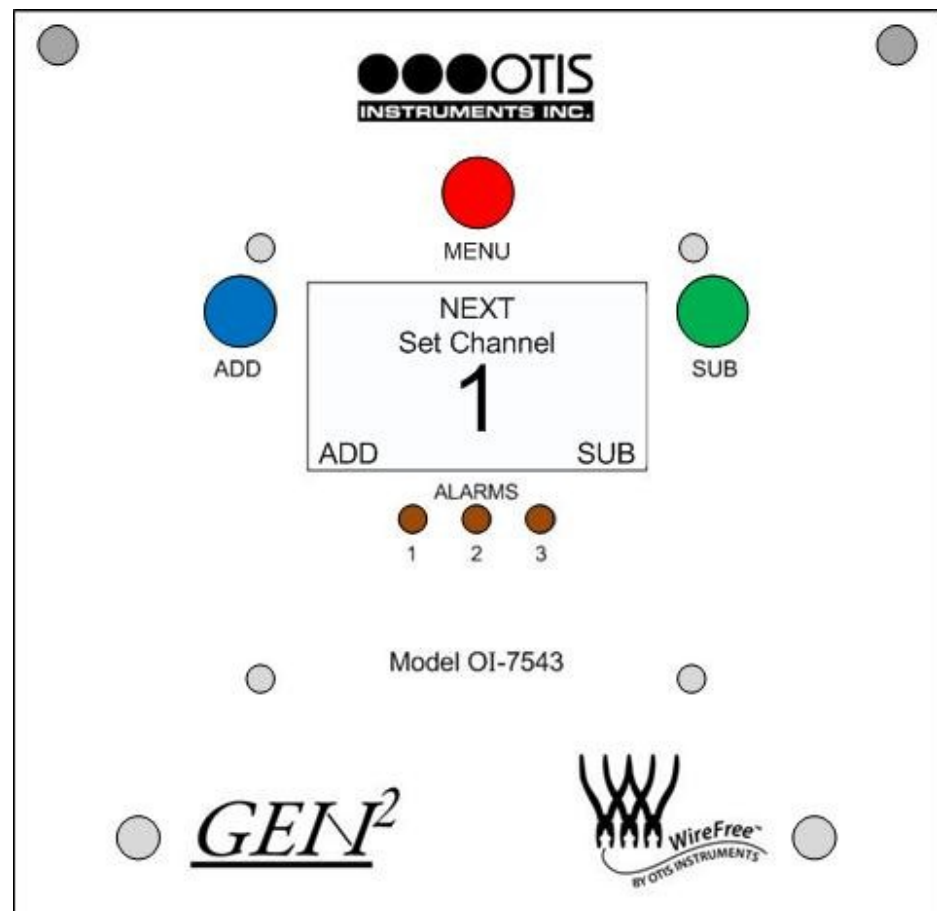

## Channel On/Off

*NOTE: When a channel is turned off, the unit will reset the channel readings and alarm settings.*

1. After the channel has been selected (see previous section), touch *MENU* once.
2. The display screen should resemble this illustration (right):
3. Touch ON (*ADD*) or OFF (*SUB*) to manipulate the Channel On/Off setting.
4. If the channel is set to “On”, proceed to the next step. If the channel is set to “Off”, proceed to the “Duplicate Channel” section on page 9 of this Operation Manual.

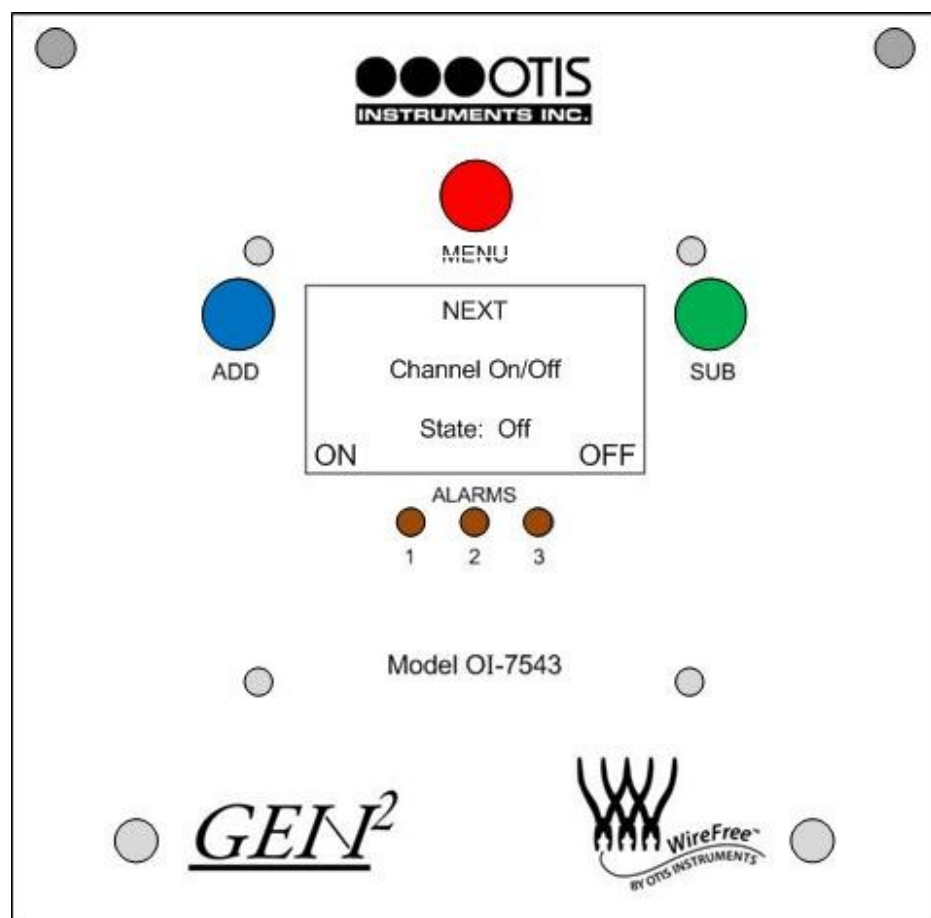

## Radio Address Setting

1. If the channel is set to “On” (see previous section), touch *MENU* once.
2. The display screen should resemble this illustration (right):
3. Touch *ADD* (increase) or *SUB* (decrease) to manipulate the Radio Address.
4. Once the Address is set, proceed to the next step.

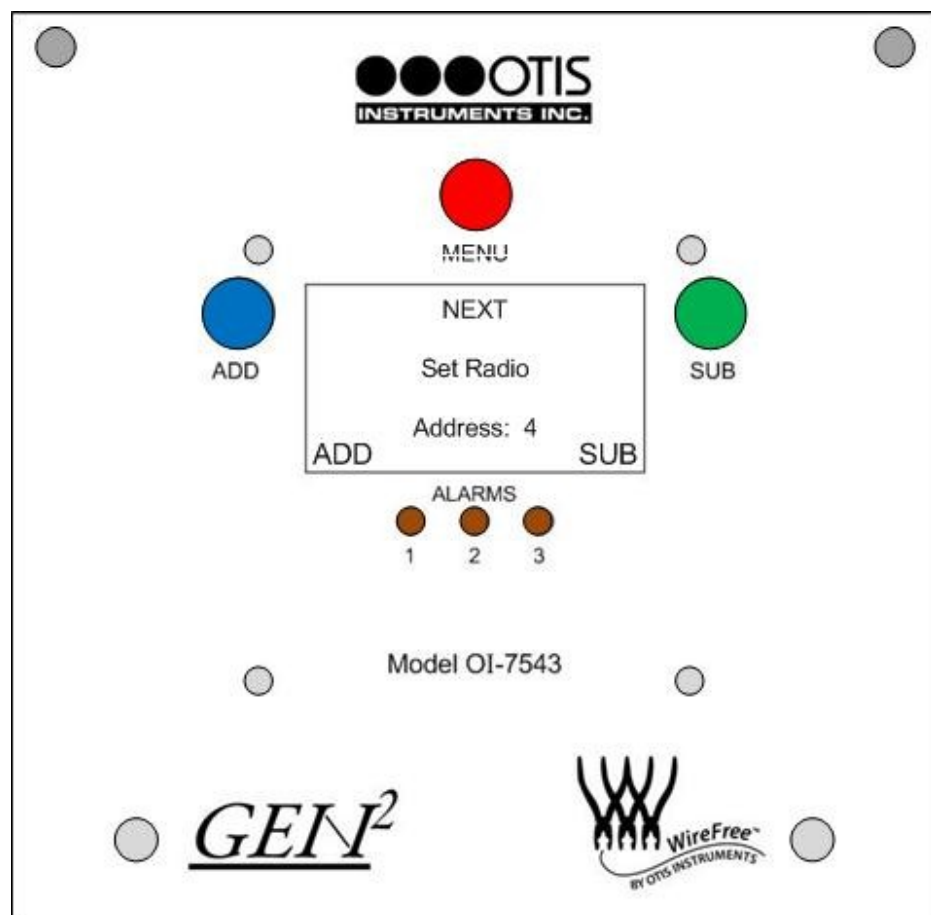

## Relay On/Off

1. After the address has been set (see previous section), touch *MENU* once.
2. The display screen should resemble this illustration (right):
3. Touch ON (*ADD*) or OFF (*SUB*) to manipulate the Relay On/Off setting.
4. If the relay is set to “On”, proceed to the next step. If the relay is set to “Off”, proceed to setting the next relays to On/Off. When setting the third relay to On/Off, if “Off” is selected, proceed to the “Duplicate Channel” section on page 9 of this Operation Manual.

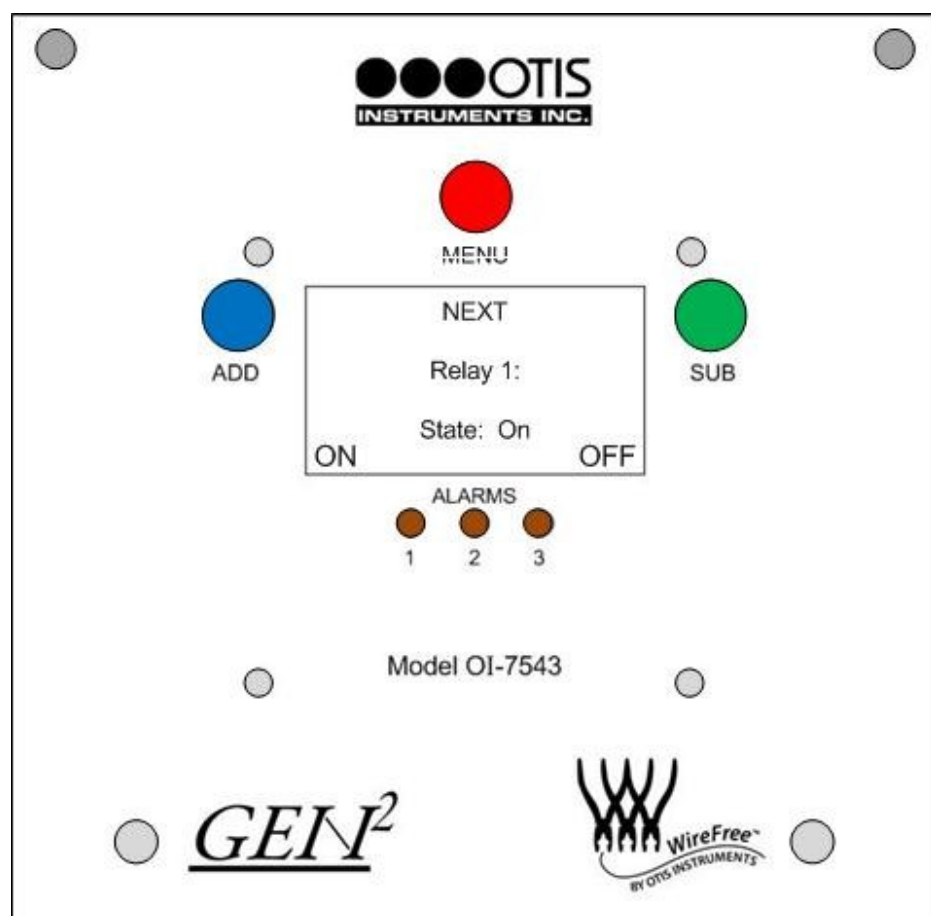

### Relay Setting-Type (Rise/Fall)

1. If the relay is set to “On” (as described in the previous section), touch *MENU* once.
2. The display screen should resemble this illustration (right):
3. Touch *RISE* (*ADD*) or *FALL* (*SUB*) to manipulate the setting type of the relay.
4. Once the Relay Setting-Type is set, proceed to the next step.

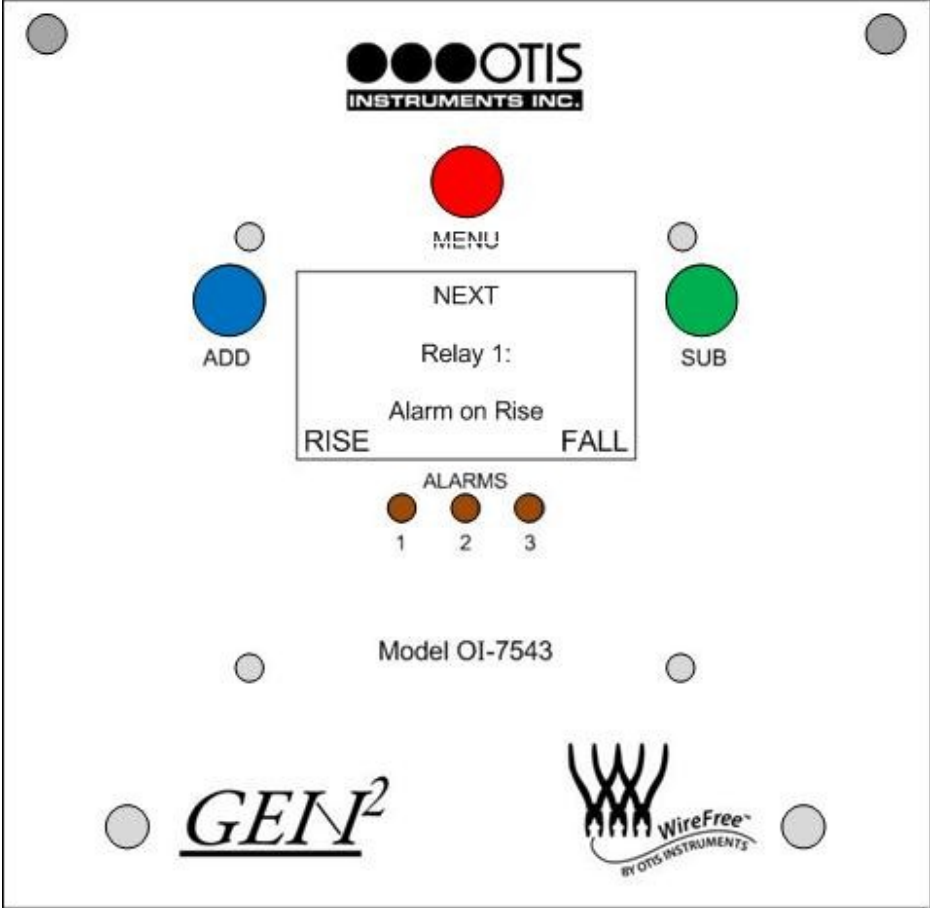

### Relay Value Setting

1. Once the Relay Setting-Type has been selected (see previous section), touch *MENU* once.
2. The display screen should resemble this illustration (right):
3. Touch *ADD* (increase) or *SUB* (decrease) to manipulate the Relay Value Setting.
4. Once the Relay Value Setting is selected, proceed to the next step.

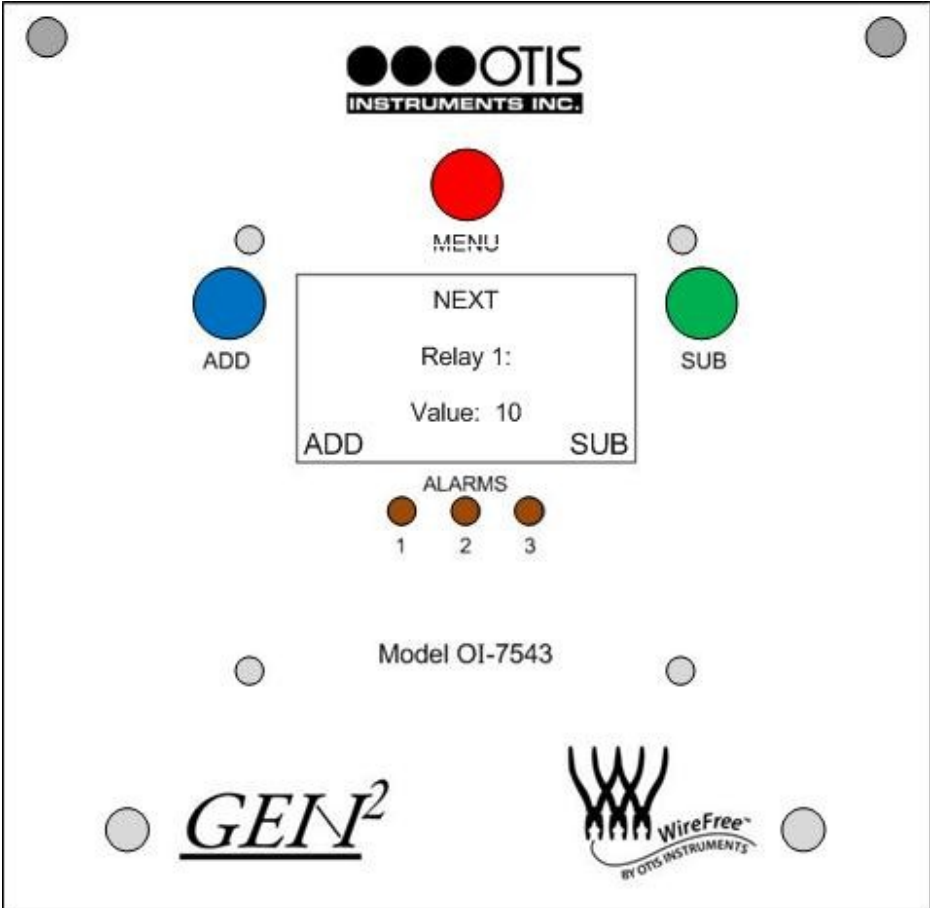

### Relay Latching/Unlatching

1. Once the Relay Value has been selected (see previous section), touch *MENU* once.
2. The display screen should resemble this illustration (right):
3. Touch *ADD* (increase) or *SUB* (decrease) to manipulate the Relay Latching/Unlatching Setting.
4. Once Relay is set to latching or unlatching, proceed to the next step.

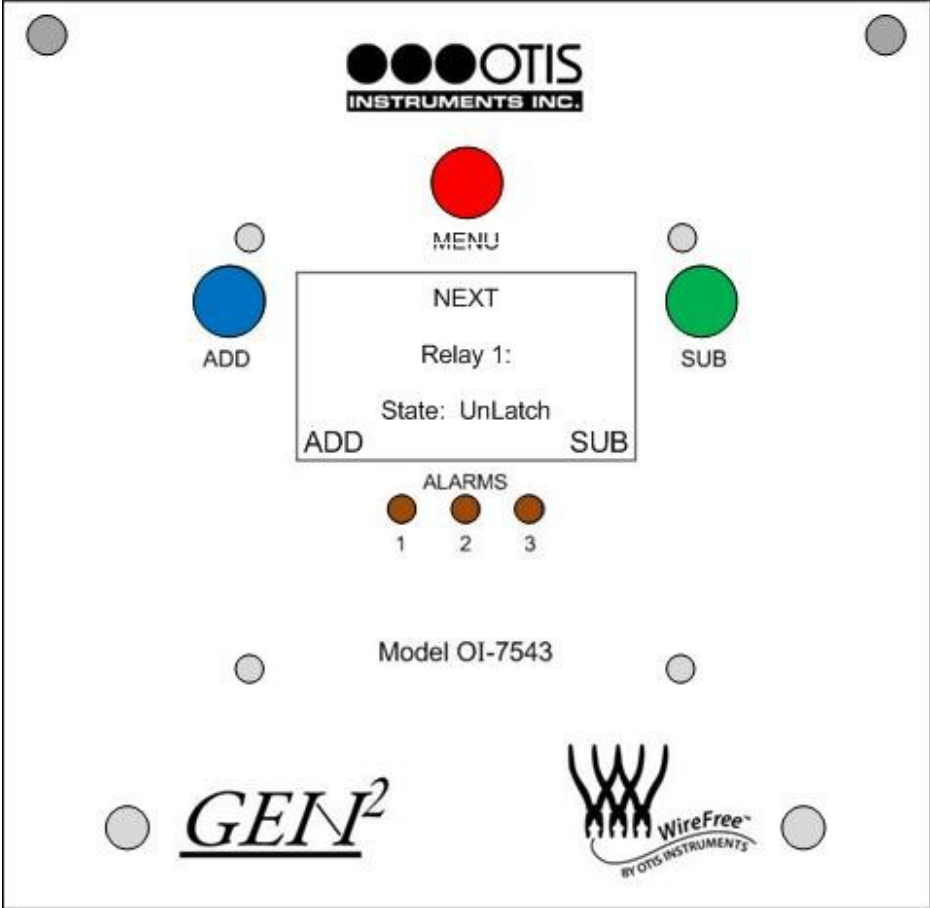

**RELAY SETUP MUST BE COMPLETED INDIVIDUALLY FOR EACH RELAY.  
 REPEAT THE RELAY SETUP STEPS (THE PREVIOUS FOUR SECTIONS) FOR EACH OF THE THREE RELAYS.  
 ONCE ALL THREE RELAYS HAVE BEEN SETUP, CONTINUE TO THE NEXT STEP.**



## Duplicate Channel

1. After the Channel has been setup (or turned off), touch *MENU* once.
2. The display screen should resemble the illustration to the right:
3. Touch YES (*ADD*) to duplicate the channel. Touch *MENU* to decline the duplication option and proceed to setup the next channel.

*NOTE: To exit the Basic Configuration Menu at any time, touch ADD/SUB until you reach the Information Screen and then touch MENU.*

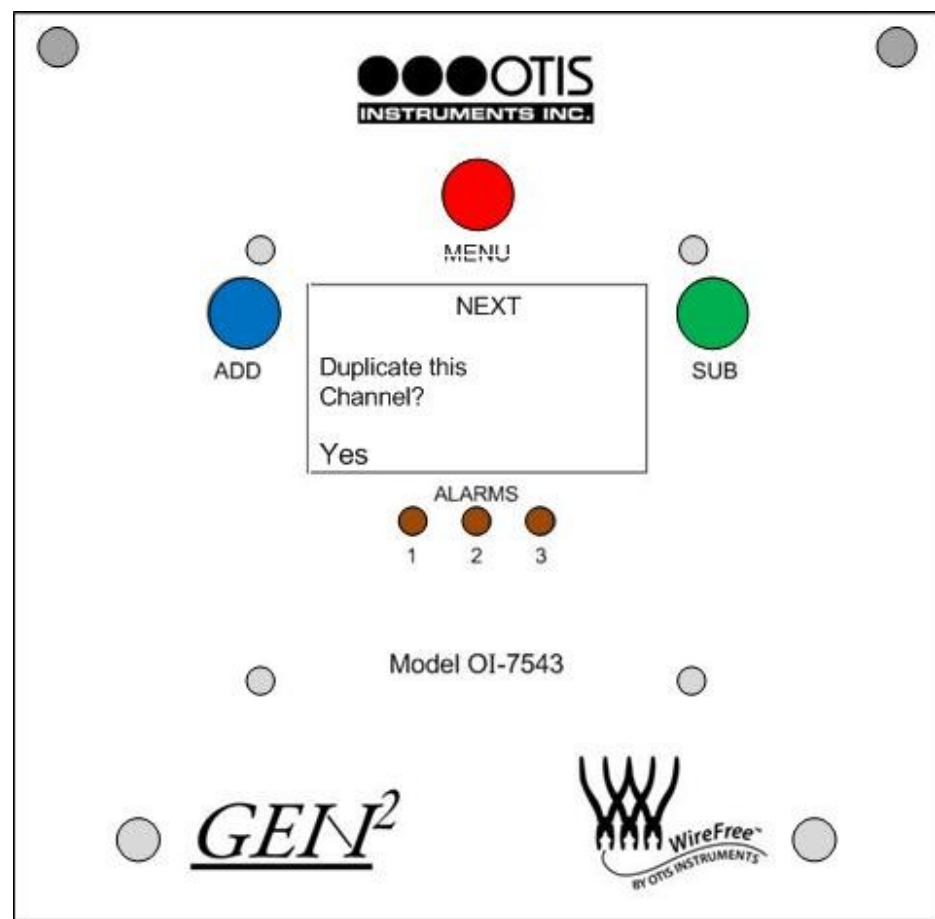

**CHANNEL SETUP MUST BE COMPLETED INDIVIDUALLY FOR EACH CHANNEL.  
REPEAT THE CHANNEL SETUP INSTRUCTIONS FOR EACH CHANNEL BEFORE USE.**

## Advanced Configuration Menu (Global Settings)

The Advanced Configuration Menu is used to manipulate global settings. To setup individual channels, use the Basic Configuration Menu.

*NOTE: To exit the Basic Configuration Menu at any time, touch ADD and then touch MENU.*

### Entering Advanced Configuration Menu

1. Cycle the unit's power (turn OFF, then ON). Power off the device by turning off the voltage supply at the power source (DC power), or by unplugging the unit (AC power). Power on the device by supplying voltage to the unit.
2. Open the enclosure box.
3. When the Otis Logo is shown on the Display Screen, press *MENU*.

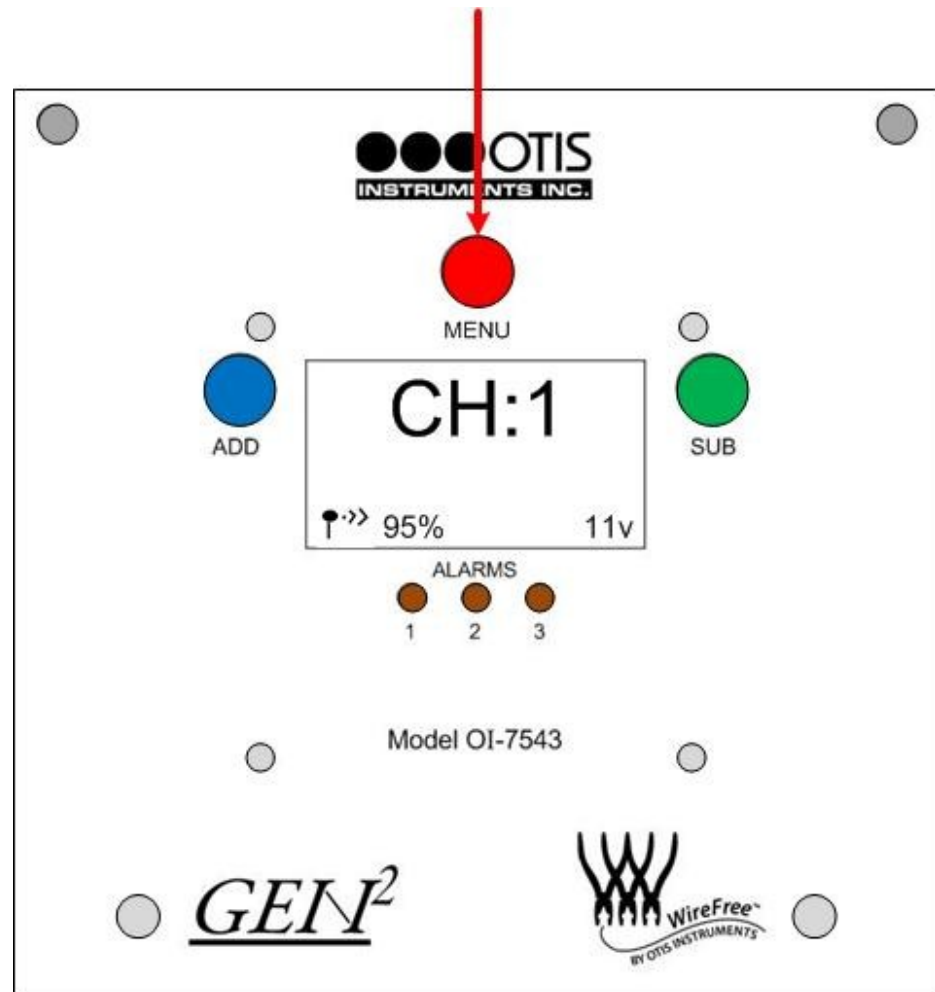

### Adjusting LCD Contrast

Press *ADD* (increase) or *SUB* (decrease) to manipulate the LCD contrast. Press *MENU* (Next) to confirm the setting.

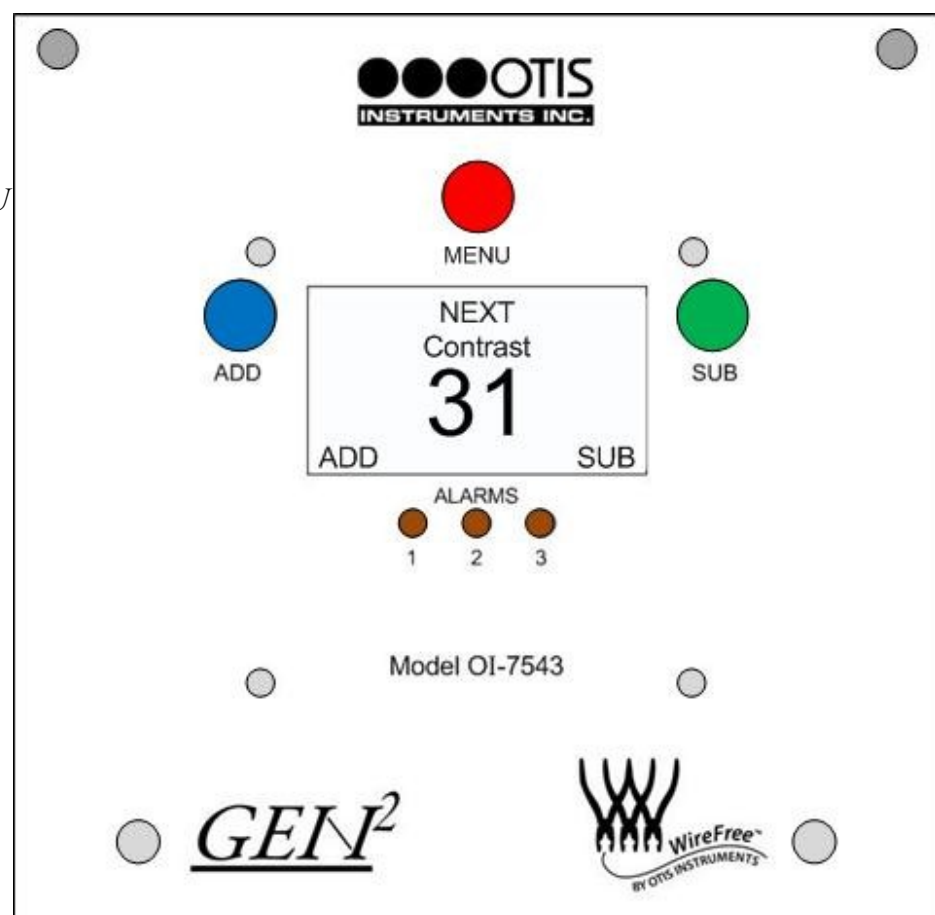

## Restore Factory Default Settings

Touch *ADD* or *SUB* (Yes/No—as indicated on the display screen) to set the unit back to the factory's default settings. Press *MENU* (Next) to confirm the setting.

Factory settings are:

- Channels 1-4 “On”
- All Relays set ”On” at 10, 15, 20; Unlatching; Rising
- Channel Addresses set to 1-4
- Network Channel set to 5
- Secondary Monitor
- Radio Timeout is 10 minutes

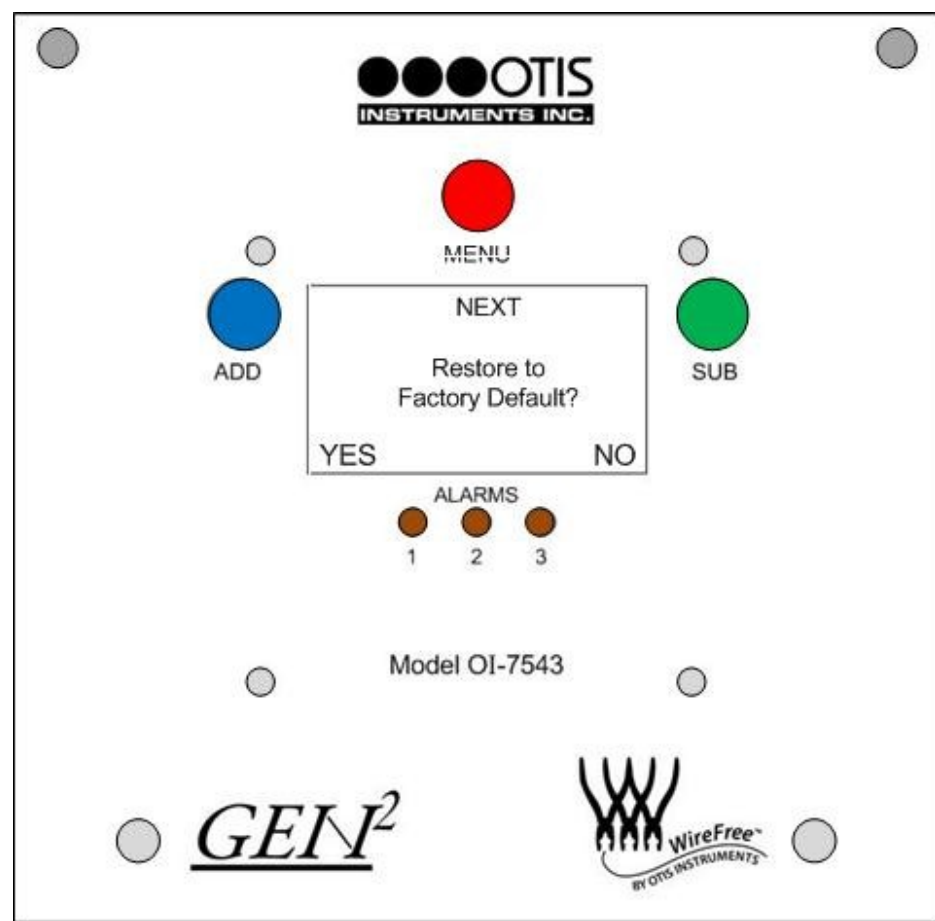

## Fault Relay Setup: Relay 3 Fault Relay

Touch *ADD* or *SUB* (Yes/No—as indicated on the display screen) to setup Relay 3 as the Fault Relay. Press *MENU* (Next) to confirm the setting.

*NOTE: With this feature enabled, if any Fault occurs (on any channel) the Fault Relay is engaged. In addition, Relay 3 is removed from all setup options.*

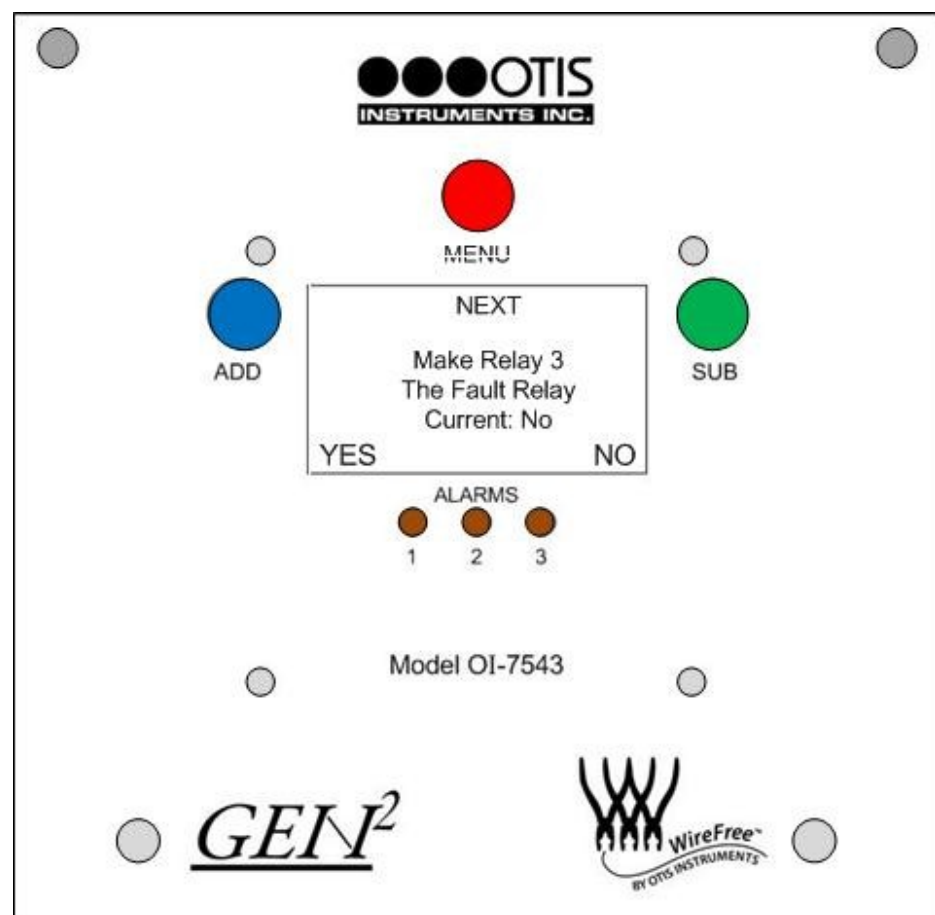

## Fault Relay Setup: Latching or Unlatching

*NOTE: This option will only appear if “Yes” is chosen on the previous option, setting Relay 3 as a Fault Relay. If “No” is chosen on the previous option, continue to the next step.*

Touch *ADD* or *SUB* (Yes/No—as indicated on the display screen) to set Relay 3 as Latching or Unlatching. Press *MENU* (Next) to confirm the setting.

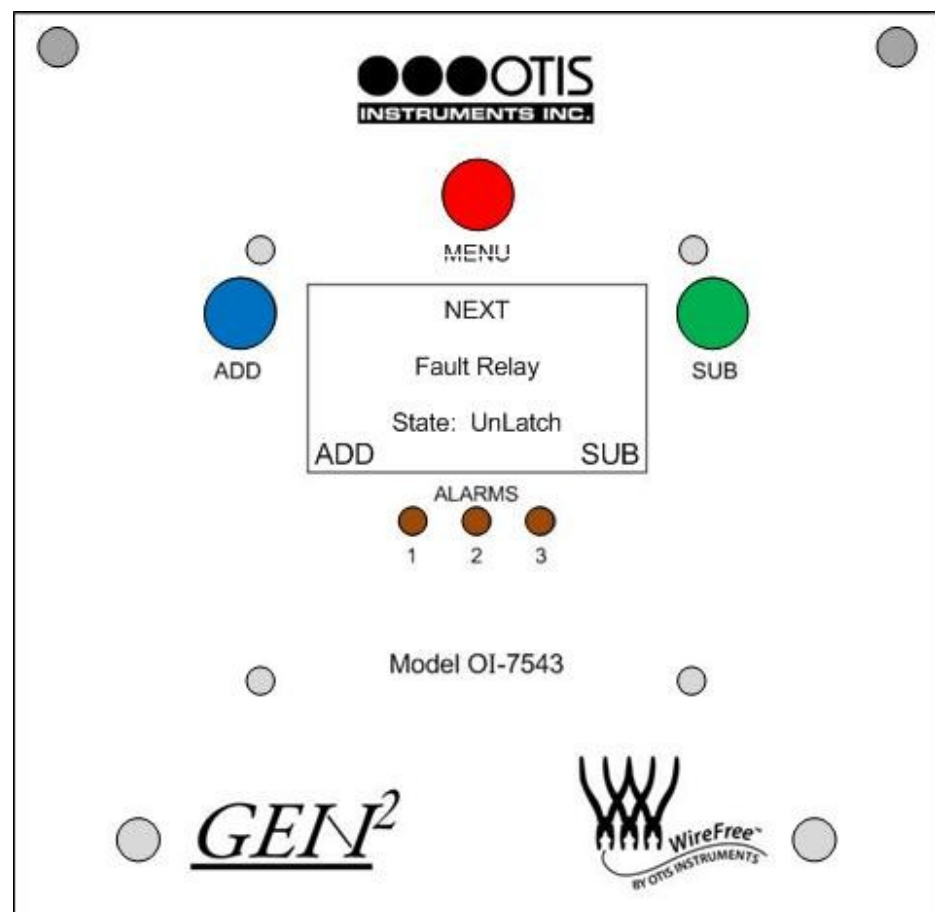

**Relay Failsafe Setup: Relay 1 Failsafe (right)**

Touch *ADD* or *SUB* (Yes/No—as indicated on the display screen) to set the Relay 1 Failsafe Setting. Press *MENU* (Next) to confirm the setting (right).

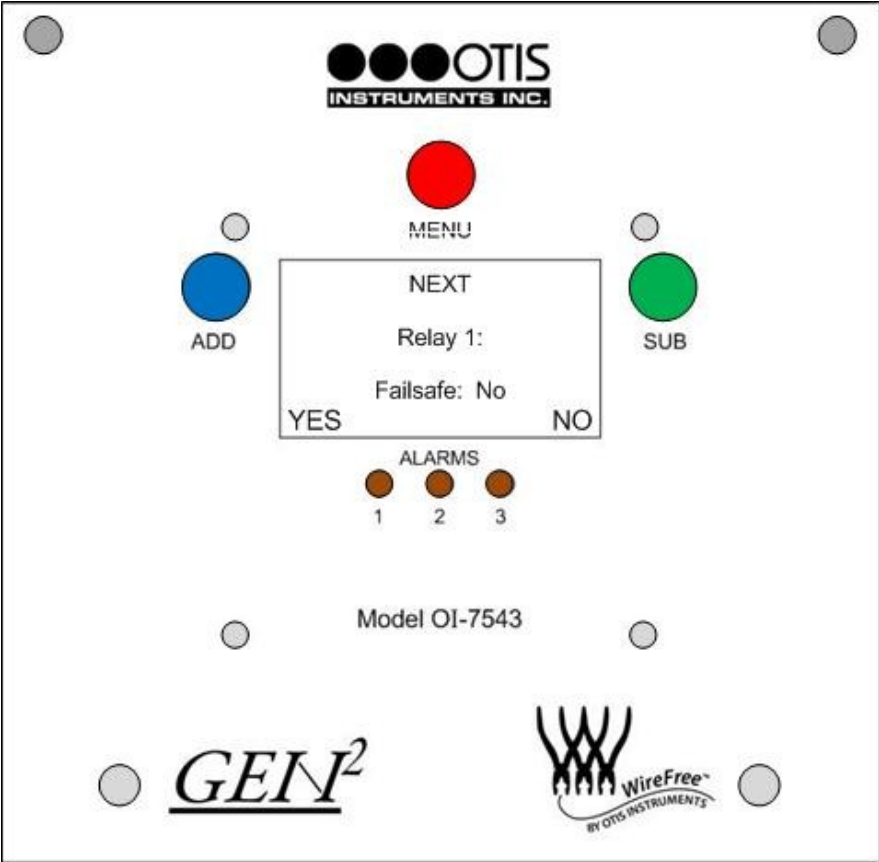

**Relay Failsafe Setup: Relay 2 Failsafe (below)**

Touch *ADD* or *SUB* (Yes/No—as indicated on the display screen) to set the Relay 2 Failsafe Setting. Press *MENU* (Next) to confirm the setting (below).

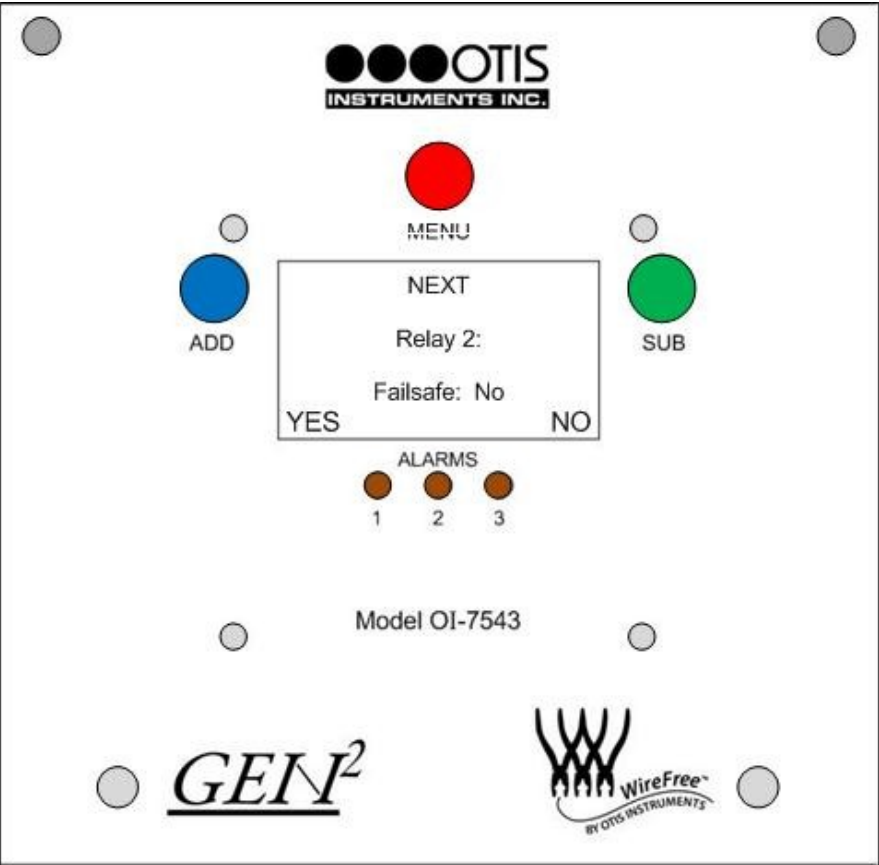

**Relay Failsafe Setup: Relay 3 Failsafe (right)**

Touch *ADD* or *SUB* (Yes/No—as indicated on the display screen) to set the Relay 3 Failsafe Setting. Press *MENU* (Next) to confirm the setting (right).

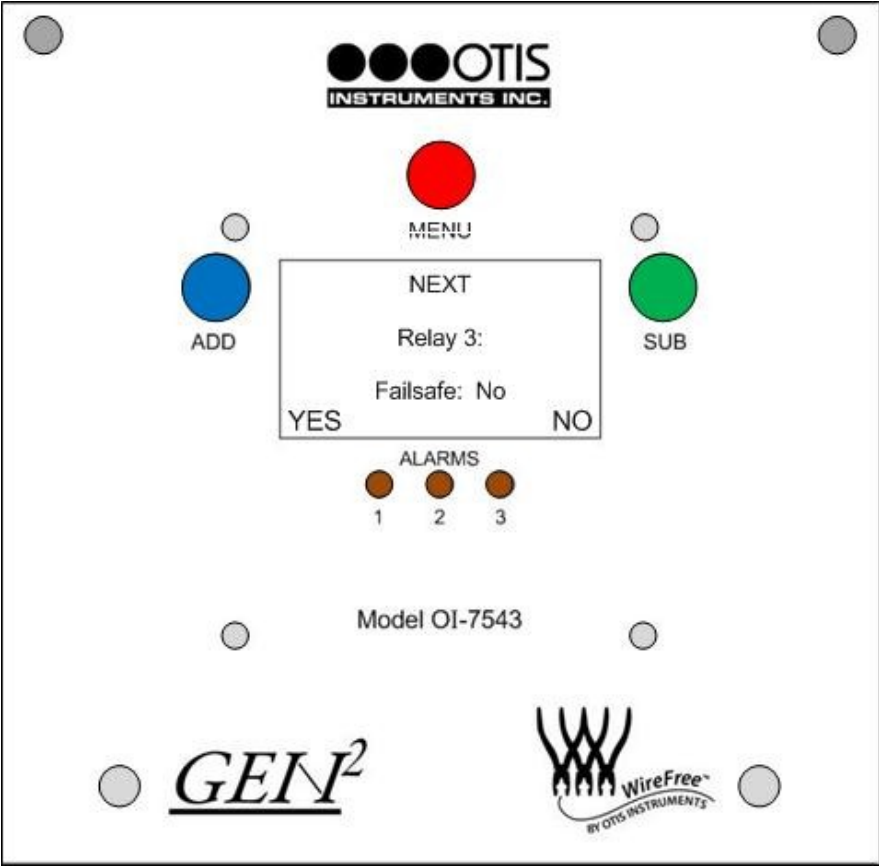

**Relay Failsafe Setup: Fault Terminal Failsafe (below)**

Touch *ADD* or *SUB* (Yes/No—as indicated on the display screen) to set the Fault Terminal Failsafe Setting. Touch *MENU* (Next) to confirm the setting (below).

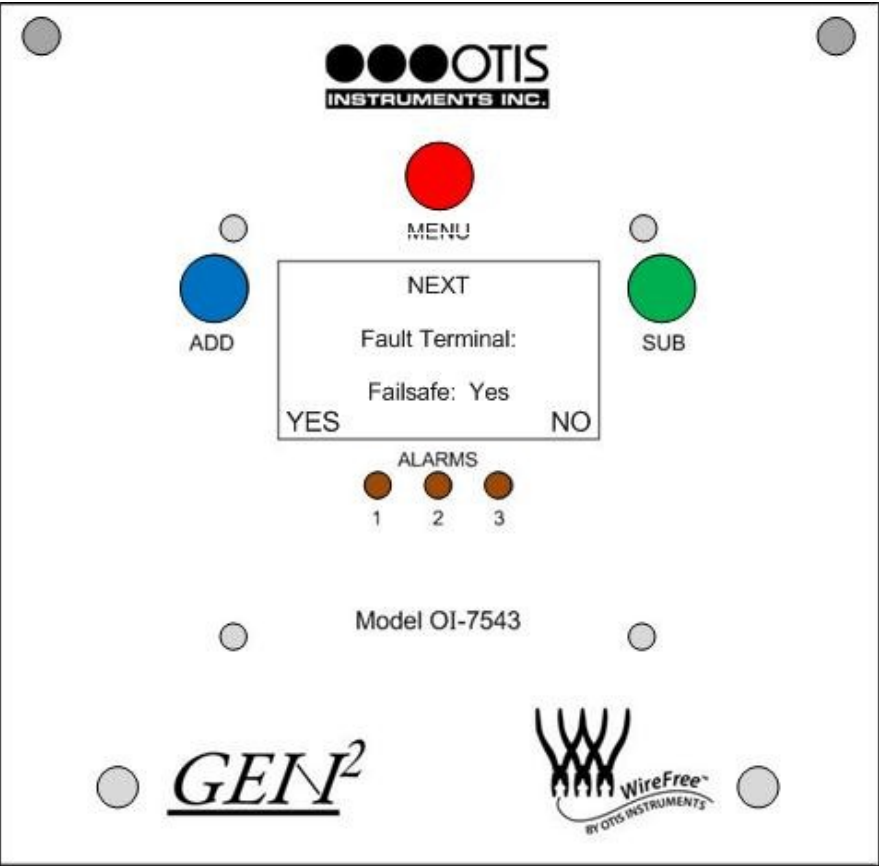

### Radio Timeout Setting

Press *ADD* (increase) or *SUB* (decrease) to manipulate the Radio Timeout Setting. Press *MENU* (Next) to confirm the setting.

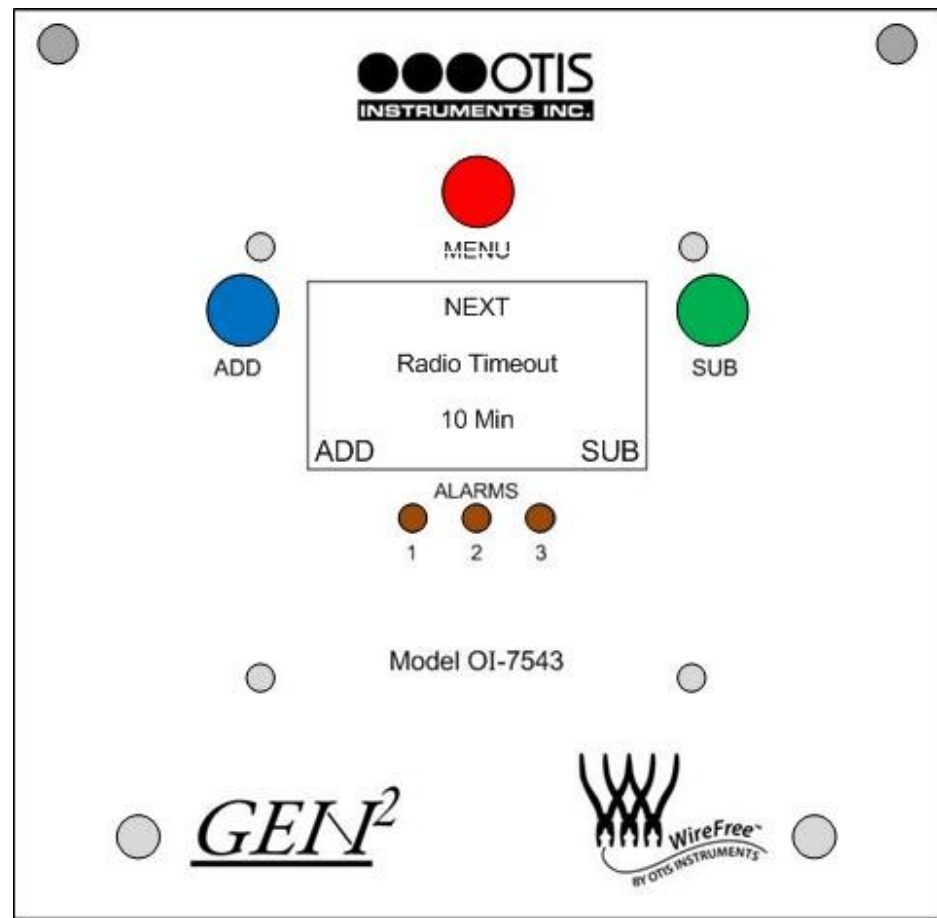

### Network Channel Setting

Touch *ADD* (increase) or *SUB* (decrease) to manipulate the Network Channel Setting. Press *MENU* (Next) to confirm the setting.

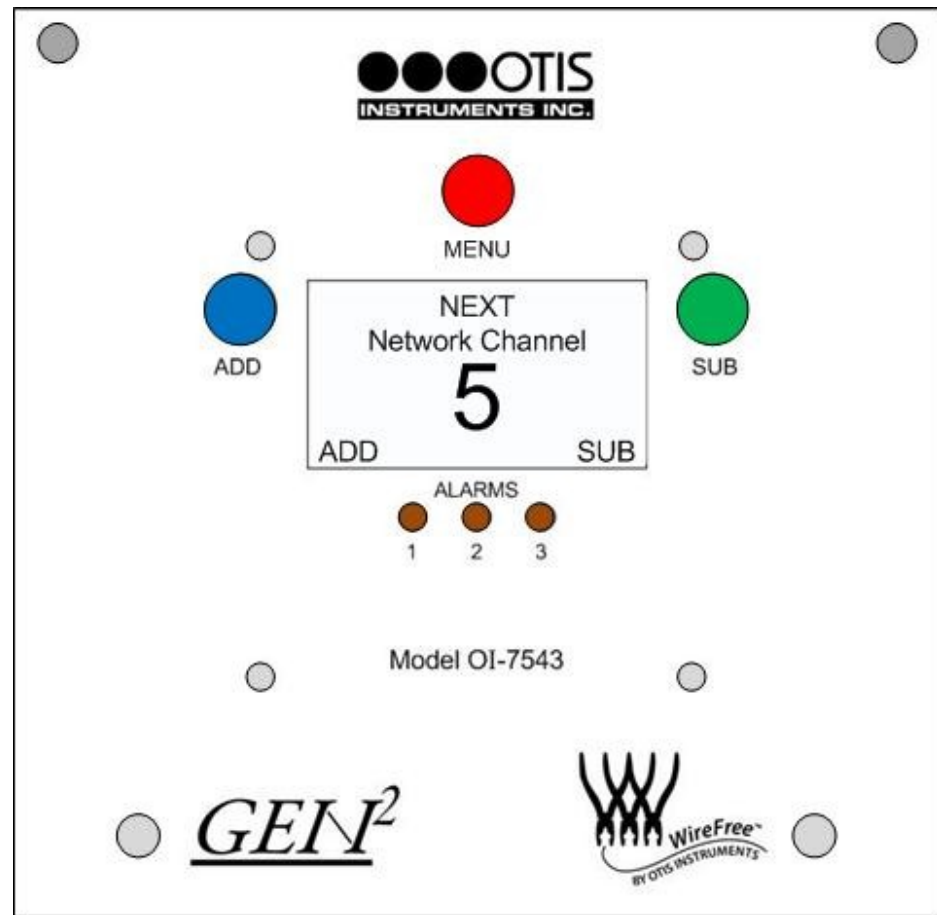

### Primary/Secondary Setting

Touch *ADD* (increase) or *SUB* (decrease) to toggle between “Primary” and “Secondary”. Touch *MENU* (Next) to confirm the setting and exit the Advanced Configuration Menu.

*NOTE: On each GenII network there can be only one “Primary” monitor—all other monitors must be setup as “Secondary” monitors.*

*NOTE: If the OI-7543 is set as a “Secondary” monitor when there is no “Primary” monitor, the OI-7543 will go into Fault 15.*

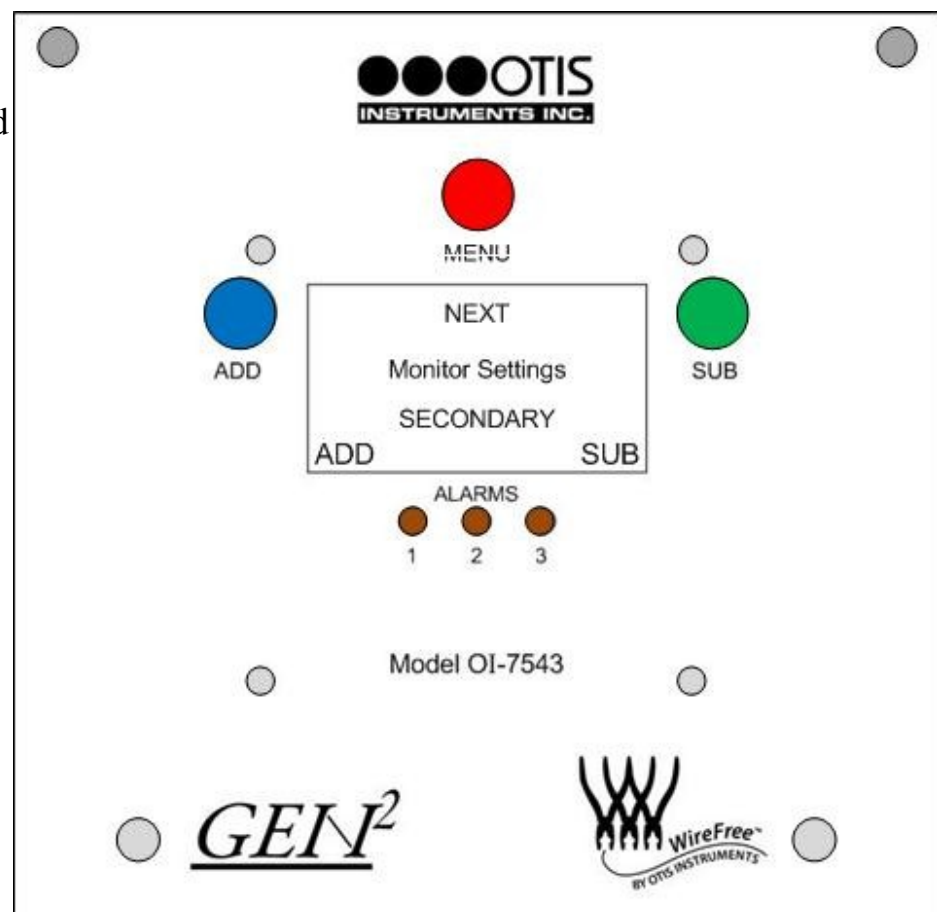

## Relay/Alarm Tests

When fully functional the OI-7543 is able to notify the user of gas presence at the sensor with a low, high, or danger alarm. To ensure that each of these features are working properly, the following tests should be run periodically. If a test is failed, the device may need to be repaired or replaced.

### Relay 1 (Low Alarm) Test

1. Press and hold *MENU* and *SUB* for five seconds to enter Alarm Test Mode.
2. To pass the Low Alarm Test the device must do the following:
  - LED “1” will illuminate
  - Any connected alarm will trigger
3. If the system passes the Low Alarm Test, proceed to the next test.

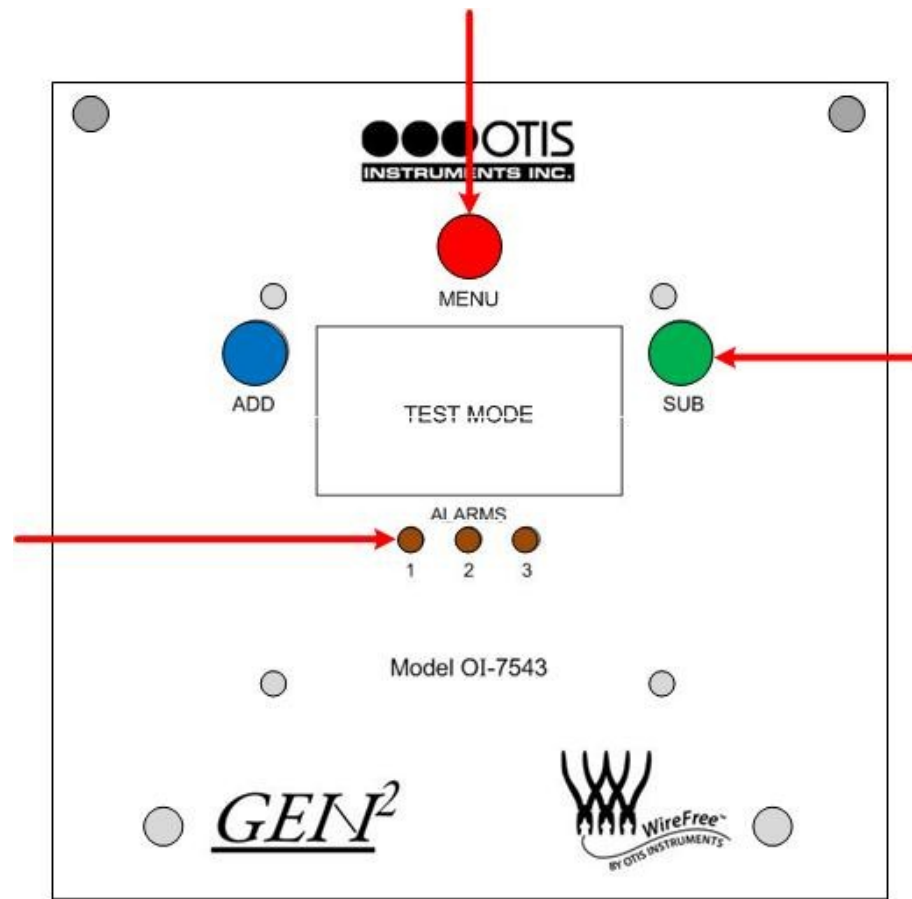

### Relay 2 (High Alarm) Test

1. Continue holding the magnets to *MENU* and *SUB* for an additional five seconds.
2. To pass the High Alarm Test the device must do the following:
  - LED “2” will illuminate
  - Any connected alarm will trigger
3. If the system passes the High Alarm Test, proceed to the next test.

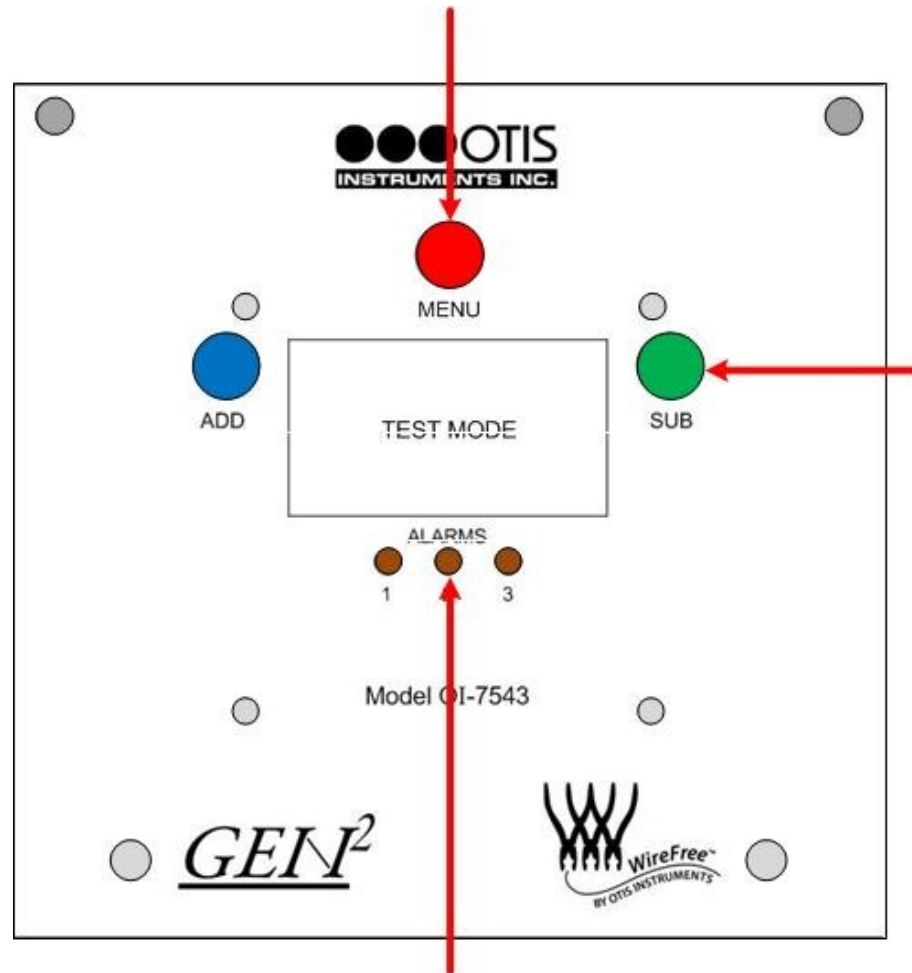

### Relay 3 (Danger Alarm) Test

1. Continue holding the magnets to *MENU* and *SUB* for an additional five seconds.
2. To pass the Danger Alarm Test the device must do the following:
  - LED “3” will illuminate
  - Any connected alarm will trigger
3. Once the Danger Alarm Test is complete, release the *MENU* and *SUB* buttons, then press *MENU* again to exit Alarm Test Mode.

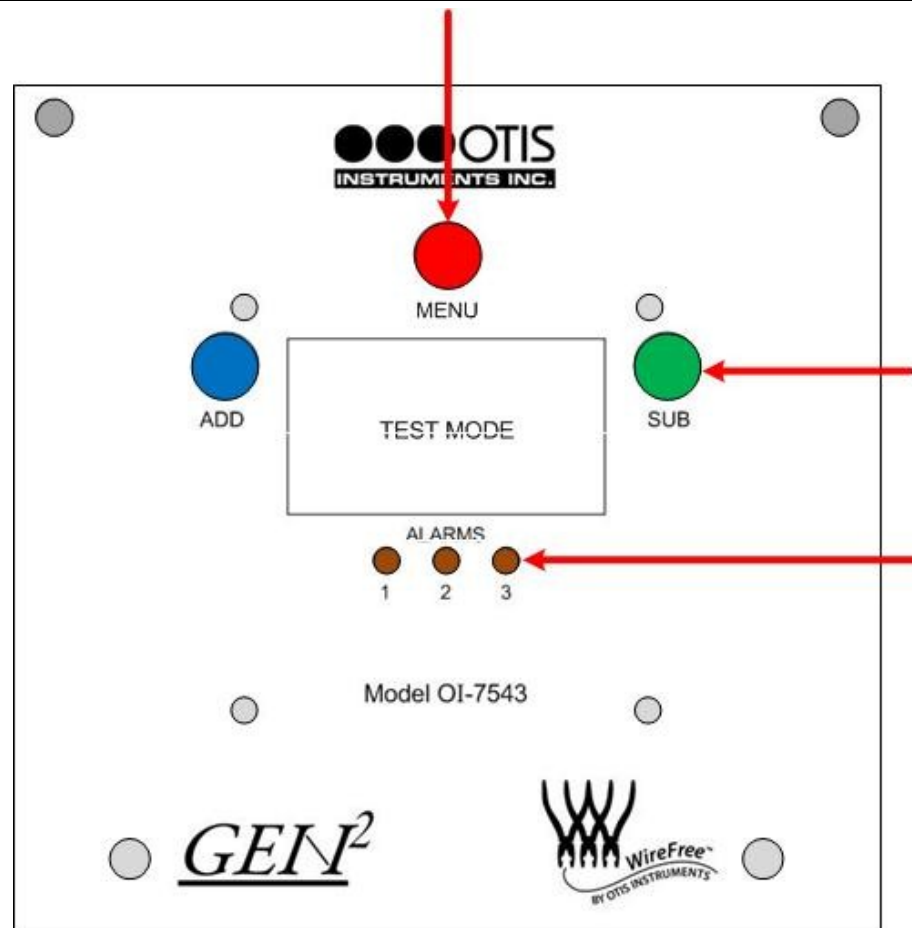

# Antenna Replacement

The antenna is used to aid in receiving clear and reliable radio signals from the sensors. The current antenna can be replaced with any Otis Instruments supplied antenna that is compatible with the radio frequency and antenna fitting on the enclosure.

1. Power off the device by turning off the voltage supply at the power source (DC power), or by unplugging the unit (AC power).
2. Unscrew the current Antenna from the Antenna Fitting.
3. Screw the new Antenna onto the Antenna Fitting.
4. Supply power to the unit to return to Normal Operating Mode.

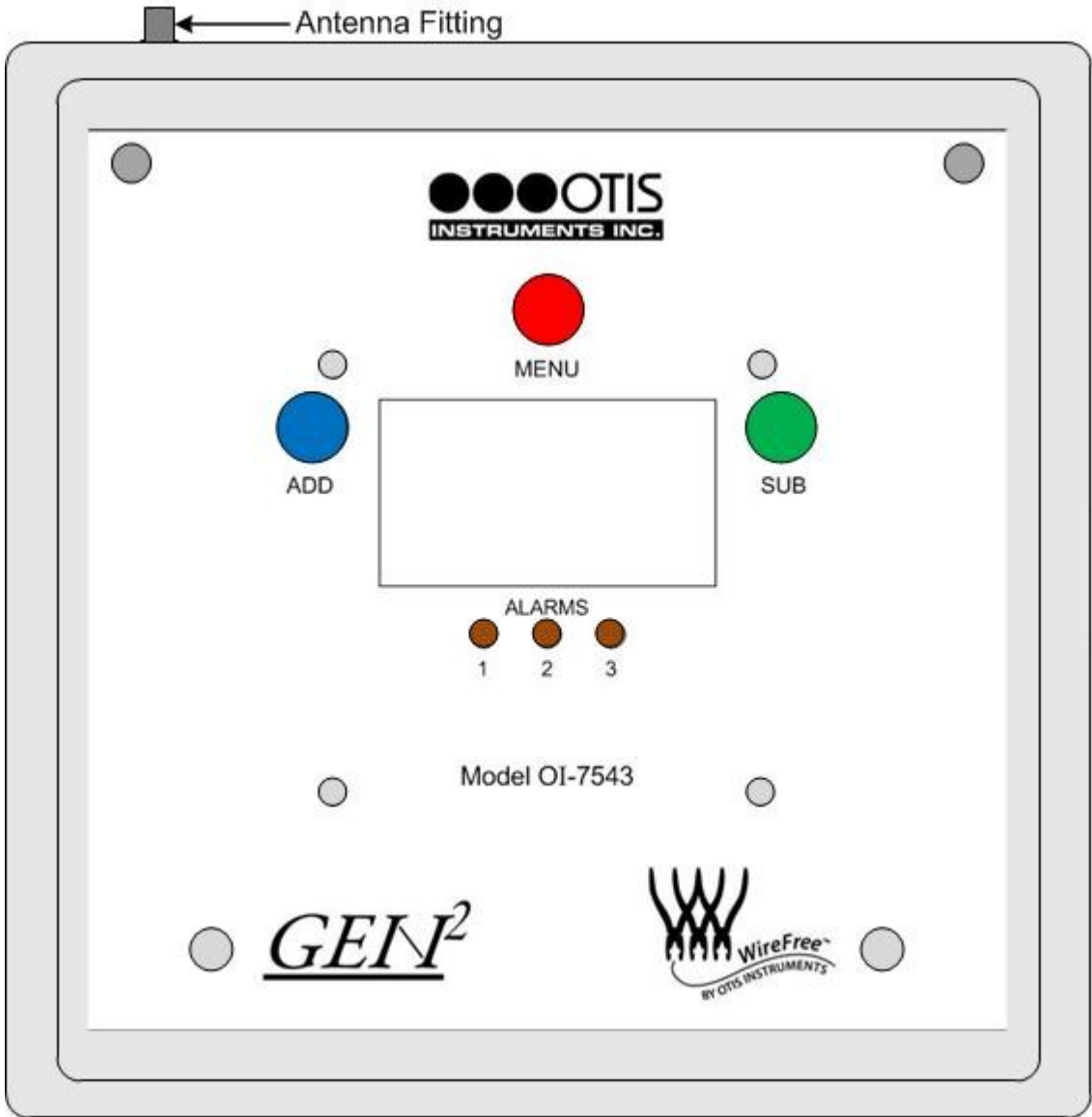

# APPENDIX A: AC Wiring Configurations

## AC Wiring Configurations

To ensure full-functionality, complete ALL of the following Wiring Configurations before installing the device in the field. *Please read all of the following items BEFORE wiring the device:*

- The relay outputs are Dry Contacts. The following relay wiring configurations are one example of a common wiring scenario. Wiring choices for certain applications may differ from what is described in this Operation Manual.
- Verify that there is no power being sent from the power supply while wiring the relays.
- Otis Instruments, Inc. recommends wiring the relays as “NO” for most applications. With a “NO” relay, the relay will only be triggered if gas is seen.
- The user may choose to wire the relays as “NC” if desired. To do so, connect the neutral wire from the power supply to the terminal labeled “NC” (Normally Closed) instead of the terminal labeled “NO” (Normally Open).
- The wire colors used in the following drawings are used for ease of displaying which wires go where. Although the wire colors used in these drawings are standard colors, not all applications will use the same wire colors.
- To ensure technician safety, always wire the relays BEFORE supplying power to the device.
- For optimal performance, the manufacturer recommends using a minimum of 22 gauge wire for all Wiring Configurations. Different loads require different gauge wire. Use appropriate wire size, depending on the voltage and current requirements.

## AC Power Supply Wiring Configurations

*NOTE: The unit will be wired for the power-type that is requested by the purchaser when shipped from Otis Instruments, Inc.*

*NOTE: To ensure technician safety, always wire the relays BEFORE supplying power to the device.*

1. Open the Enclosure Box.
2. Unscrew the two Thumbscrews.
3. Open the Front Panel.
4. Locate the “12 to 35VDC” Terminal Block on the back of the Terminal Board.
5. Locate the “-V” and “+V” terminals on the Delta Power Supply.

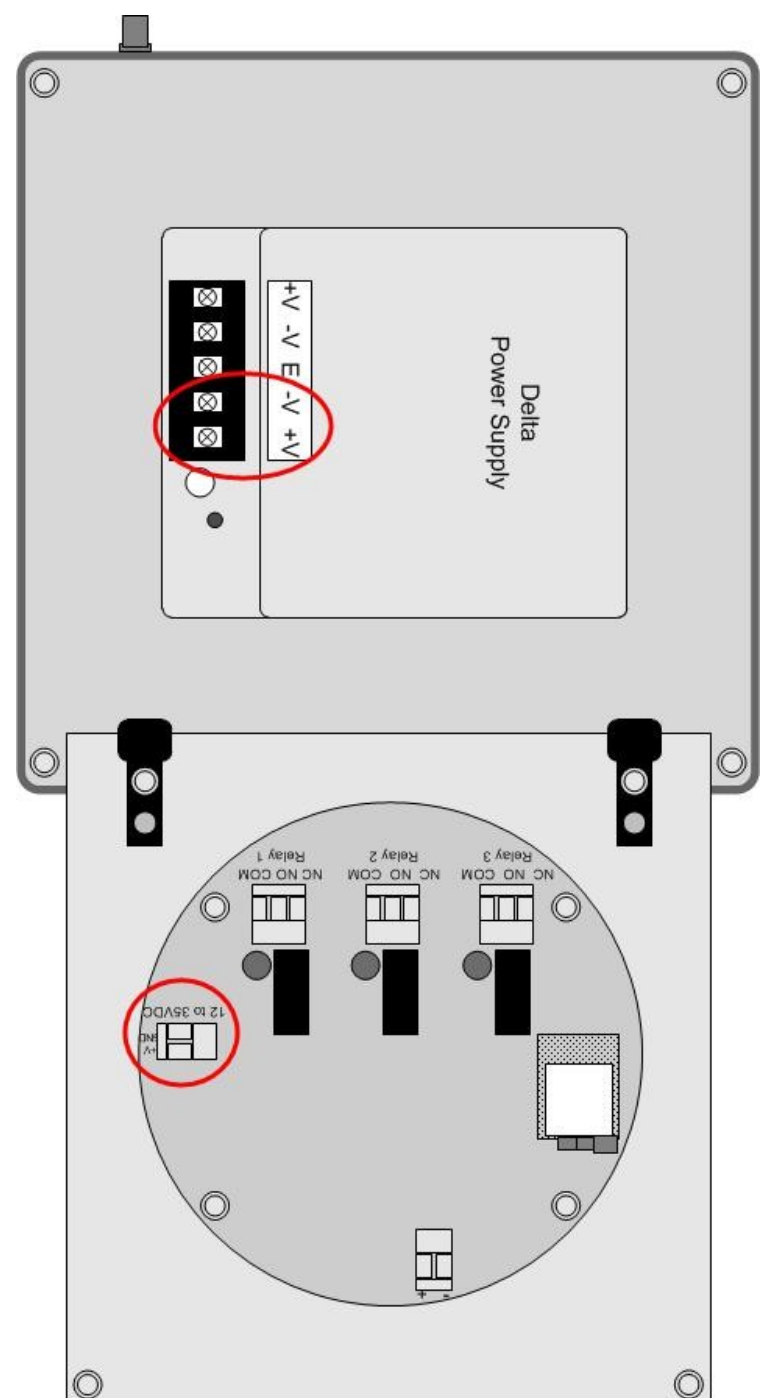

6. Connect a positive wire (red) to the terminal labeled "+V" on the Terminal Board's "12 to 35VDC" Terminal Block.
7. Connect the other end of that same positive wire (red) from the Terminal Board to the terminal labeled "+V" on the internal Delta Power Supply.
8. Connect a negative wire (black) from the terminal labeled "GND" on the Terminal Board's "12 to 35VDC" Terminal Block.
9. Connect the other end of that same negative wire (black) from the Terminal Board to the terminal labeled "-V" on the internal Delta Power Supply.
10. There will be three wires (black, white and green) pre-wired from the Delta power supply terminals to the internal AC Power Block terminals labeled: "L" (AC Load IN), "N" (AC Neutral IN), and "EG" (Chassis GND or Earth GND). This set of wires will be used to plug into an AC power outlet ONCE ALL WIRING CONFIGURATIONS ARE COMPLETE.

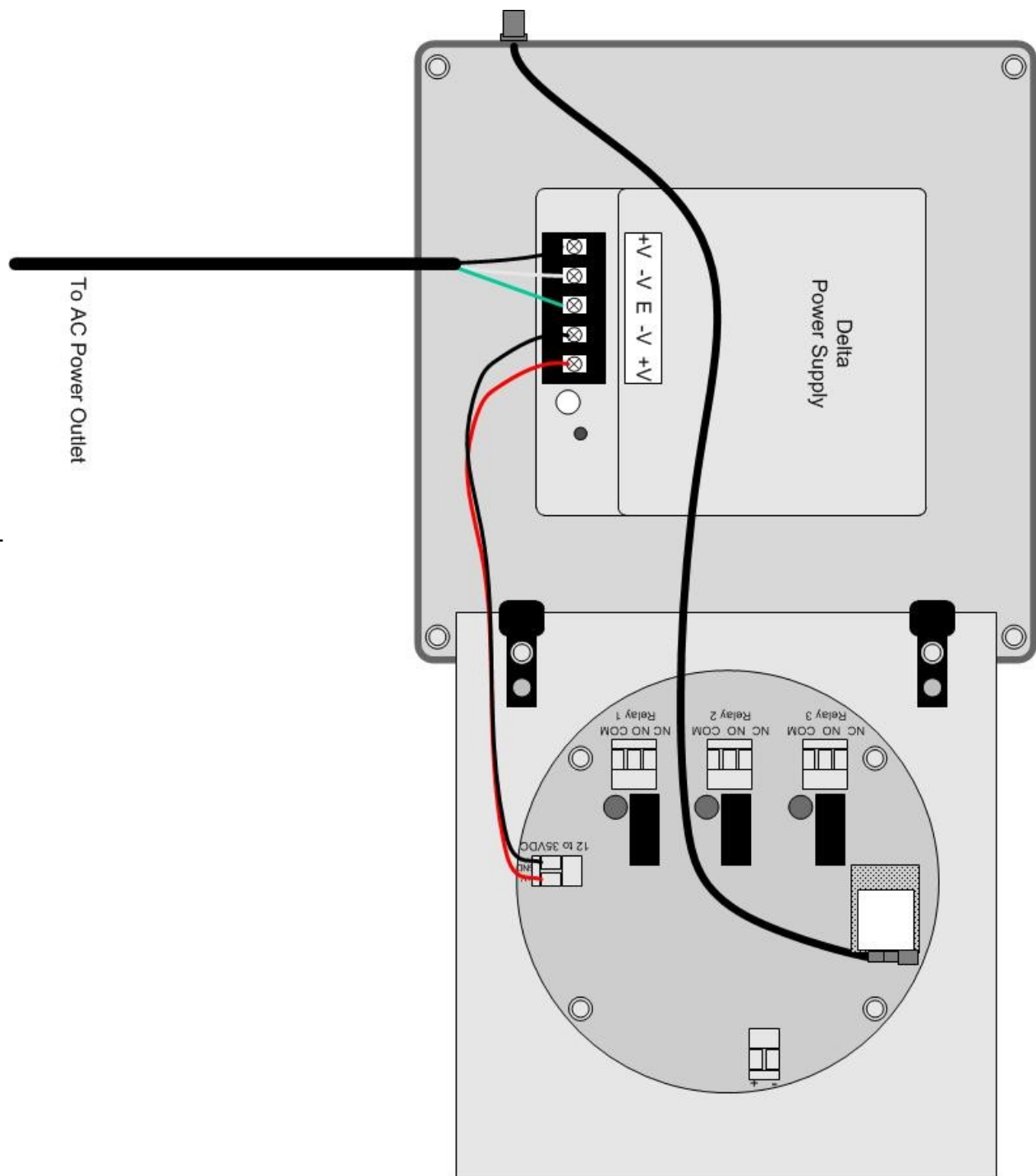

### Relay 1 (Low Alarm) Wiring Configurations

1. Open the Enclosure Box.
2. Unscrew the two Thumbscrews.
3. Open the Front Panel.
4. Using the handles on the Front Panel, lift the Front Panel completely out of the Adalet enclosure to expose the terminals on the back side of the Terminal Board.
5. Locate the Relay 1 terminal block on the back of the Terminal Board.

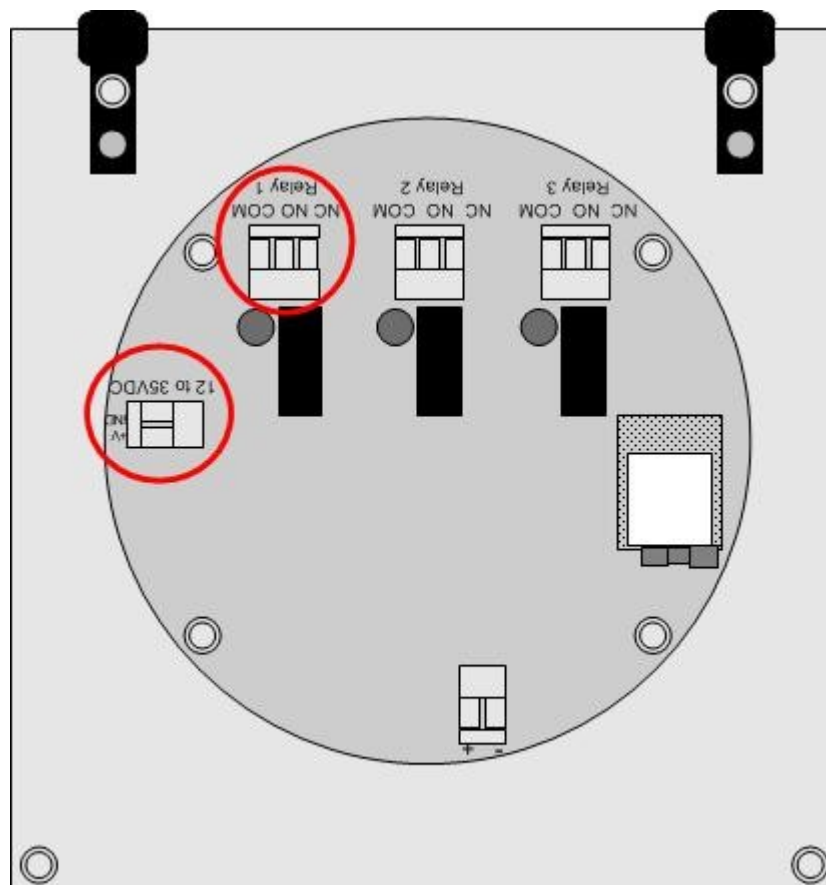



6. Connect a positive wire (red) from the terminal labeled "+V" on the Terminal Board's "12 to 35VDC" Terminal Block to the terminal labeled "COM" on the Relay 1 Terminal Block.
7. Connect the positive wire (red) from the Low Alarm to the terminal labeled "NO" (or "NC") on the Relay 1 Terminal Block.
8. Connect the neutral wire (black) from the Low Alarm to the terminal labeled "-V" on the internal Delta Power Supply.
9. Once the Relay 1 Wiring Configurations are complete, proceed to the next section.

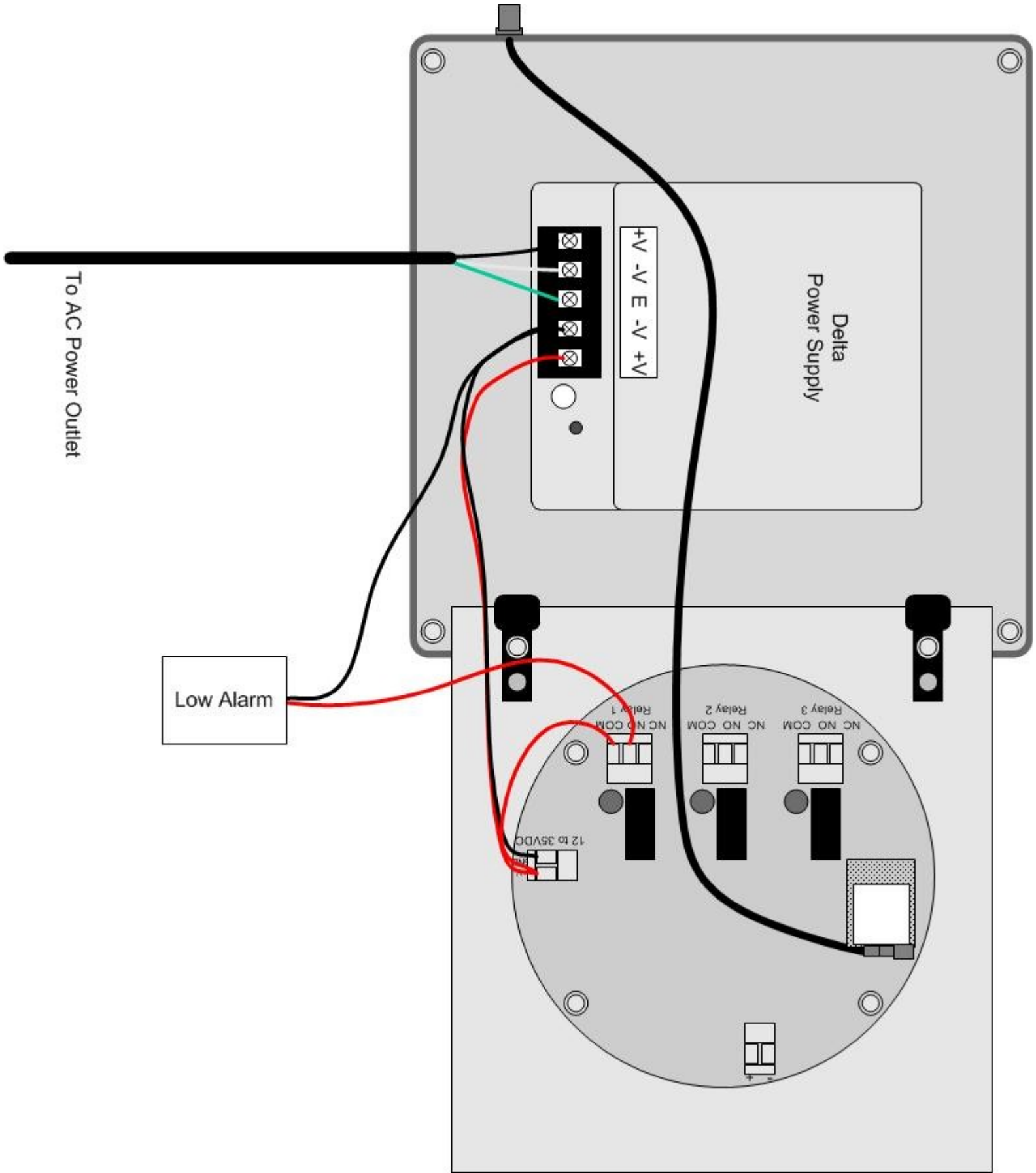

## Relay 2 (High Alarm) Wiring Configurations

1. After the Relay 1 Wiring Configurations have been completed (see previous section), locate the Relay 2 terminal block on the back of the Terminal Board.
2. Bring the two conductor cables from the High Alarm to the OI-7543 using the proper certified 3/4" NPT cable gland or conduit fitting.
3. Run the two conductor cables for Relay 2 from the High Alarm through the hub on the OI-7543 Enclosure.
4. Connect a jumper wire (blue) from the terminal labeled "COM" on the Relay 1 Terminal Block to the terminal labeled "COM" on the Relay 2 Terminal Block.
5. Connect the positive wire (red) from the High Alarm to the terminal labeled "NO" on the Relay 2 Terminal Block.
6. Connect the neutral wire (black) from the High Alarm to the terminal labeled "-V" on the internal Delta Power Supply.
7. Once the Relay 2 Wiring Configurations are complete, proceed to the next section.

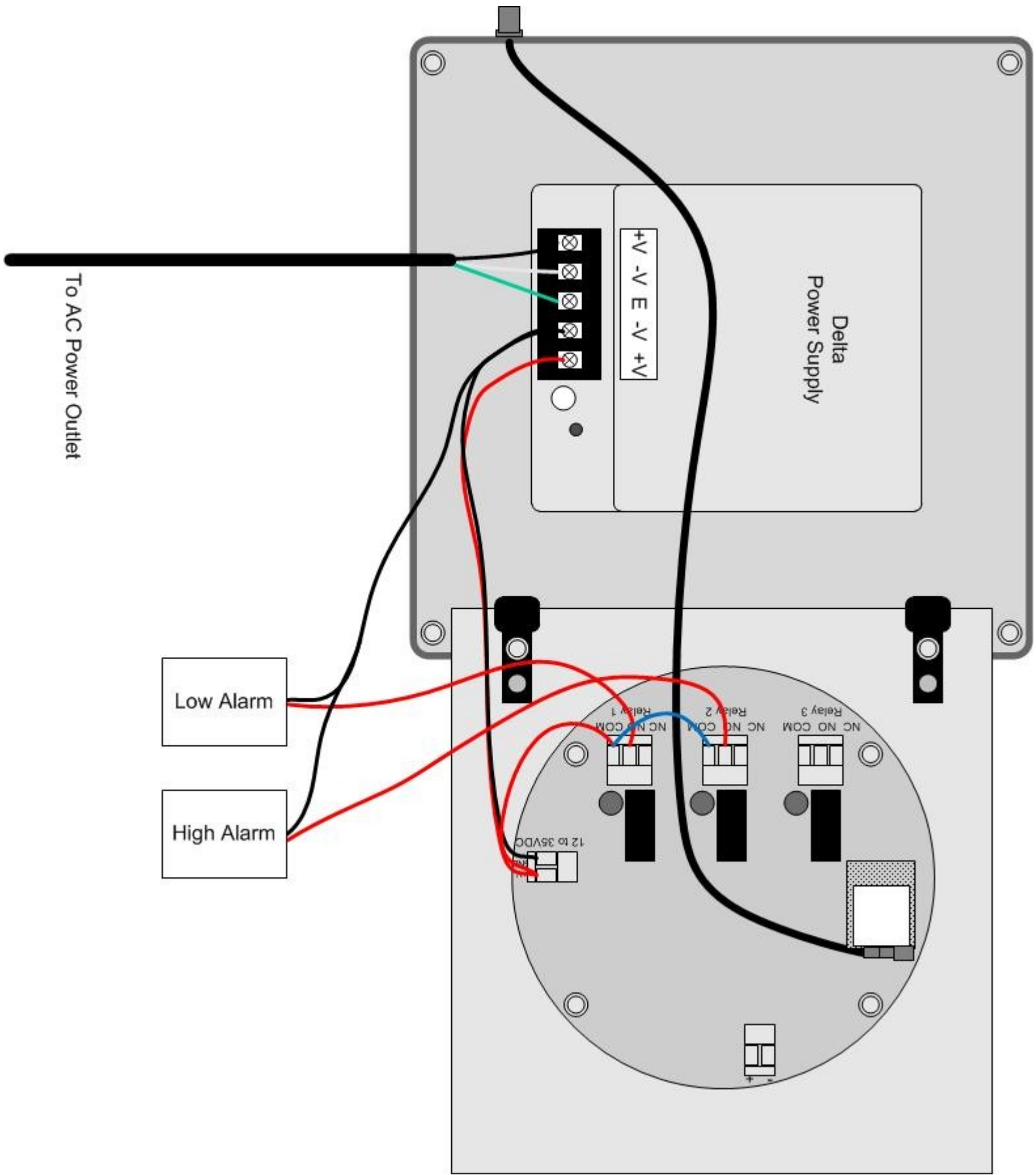
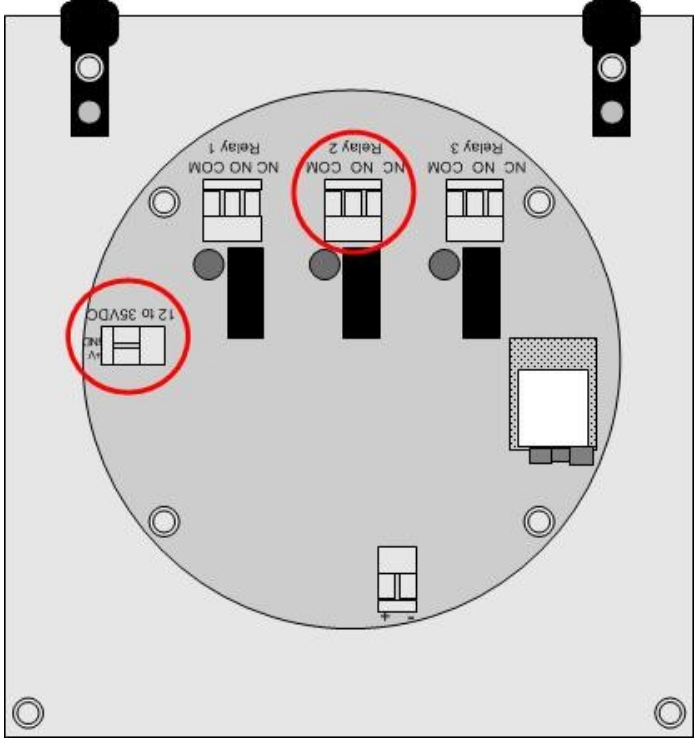

# Relay 3 (Danger Alarm) Wiring Configurations

1. After the Relay 2 Wiring Configurations have been completed (see previous section), locate the Relay 3 terminal block on the back of the Terminal Board.
2. Bring the two conductor cables from the Danger Alarm to the OI-7543 using the proper certified 3/4" NPT cable gland or conduit fitting.
3. Run the two conductor cables for Relay 3 from the Danger Alarm through the hub on the OI-7543 Enclosure.
4. Connect a jumper wire (blue) from the terminal labeled "COM" on the Relay 2 Terminal Block to the terminal labeled "COM" on the Relay 3 Terminal Block.
5. Connect the positive wire (red) from the Danger Alarm to the terminal labeled "NO" on the Relay 3 Terminal Block.
6. Connect the neutral wire (black) from the Danger Alarm to the terminal labeled "-V" on the internal Delta Power Supply.

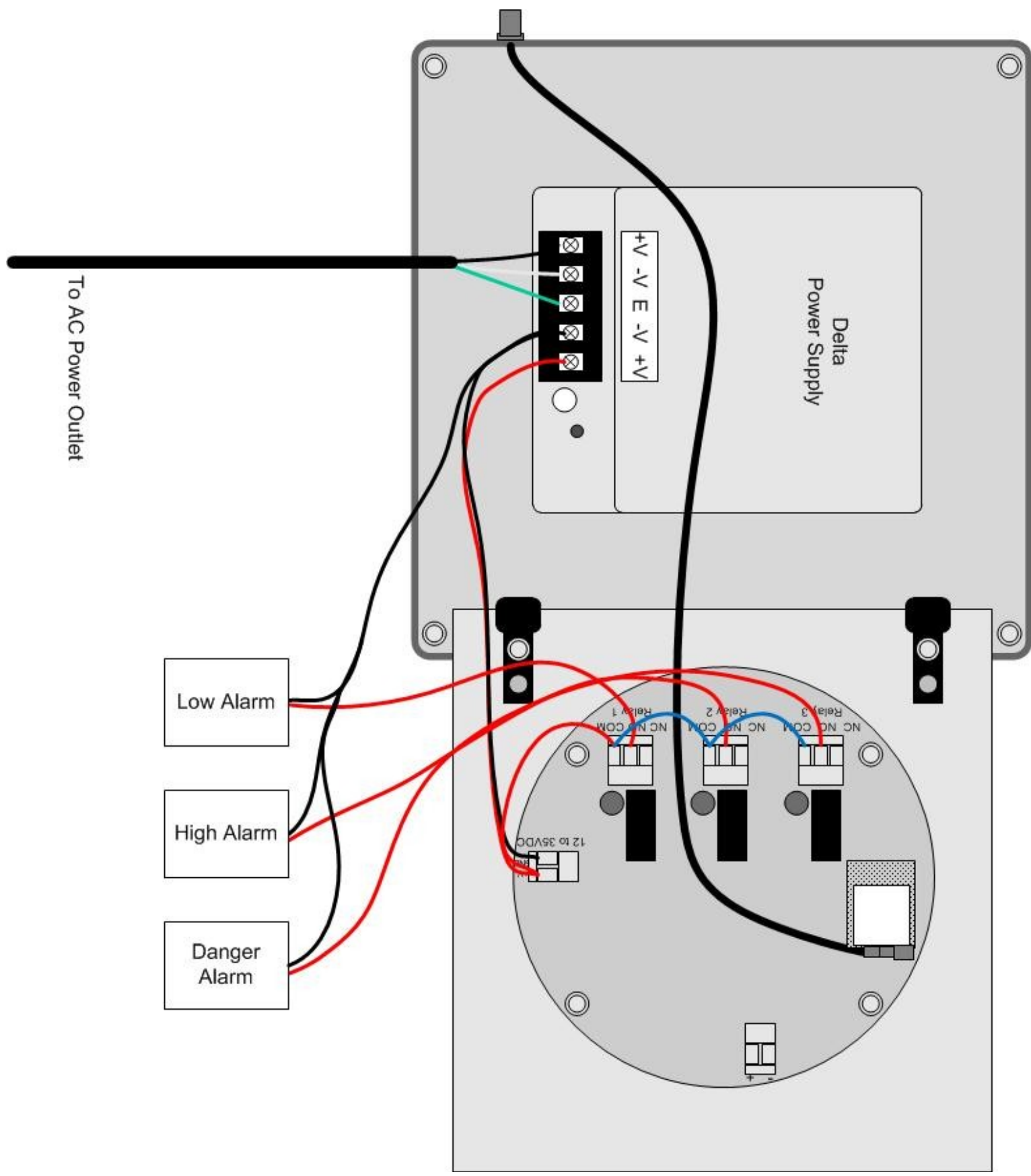
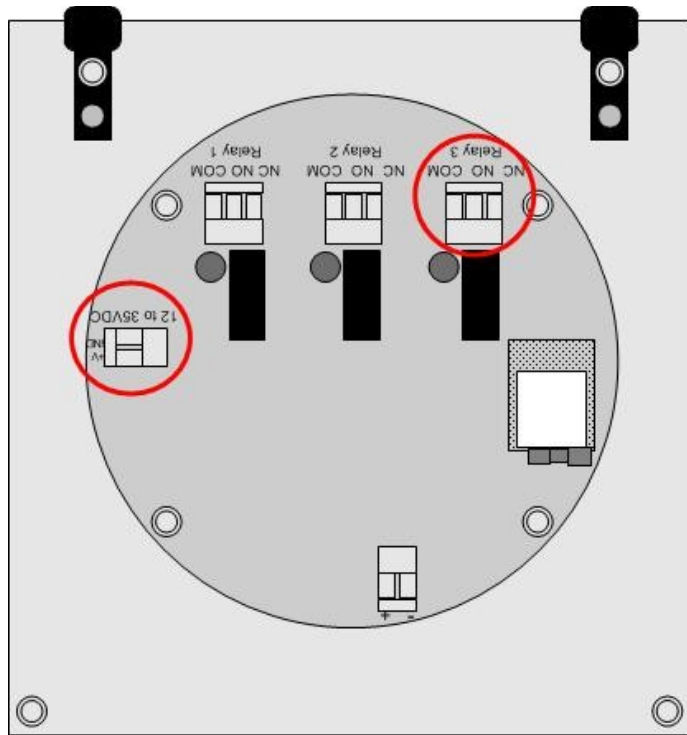

7. Close the Front Panel.
8. Screw in the Thumbscrews.
9. Close the Enclosure Box and Latch.
10. All AC Wiring Configurations are complete. Once power is supplied, the device will be fully functional and ready to operate.

## APPENDIX B: DC Wiring Configurations

### DC Wiring Configurations

To ensure full-functionality, complete ALL of the following Wiring Configurations before installing the device in the field. *Please read all of the following items BEFORE wiring the device:*

- The relay outputs are Dry Contacts. The following relay wiring configurations are one example of a common wiring scenario. Wiring choices for certain applications may differ from what is described in this Operation Manual.
- Verify that there is no power being sent from the power supply while wiring the relays.
- Otis Instruments, Inc. recommends wiring the relays as “NO” for most applications. With a “NO” relay, the relay will only be triggered if gas is seen.
- The user may choose to wire the relays as “NC” if desired. To do so, connect the neutral wire from the power supply to the terminal labeled “NC” (Normally Closed) instead of the terminal labeled “NO” (Normally Open).
- The wire colors used in the following drawings are used for ease of displaying which wires go where. Although the wire colors used in these drawings are standard colors, not all applications will use the same wire colors.
- To ensure technician safety, always wire the relays BEFORE supplying power to the device.
- For optimal performance, the manufacturer recommends using a minimum of 22 gauge wire for all Wiring Configurations. Different loads require different gauge wire. Use appropriate wire size, depending on the voltage and current requirements.

### DC Power Supply Wiring Configurations

*NOTE: The unit will be wired for the power-type that is requested by the purchaser when shipped from Otis Instruments, Inc.*

*NOTE: To ensure technician safety, always wire the relays BEFORE supplying power to the device.*

1. Open the Enclosure Box.
2. Unscrew the two Thumbscrews.
3. Open the Front Panel. Locate the “12 to 35VDC” Terminal Block on the back of the Terminal Board.

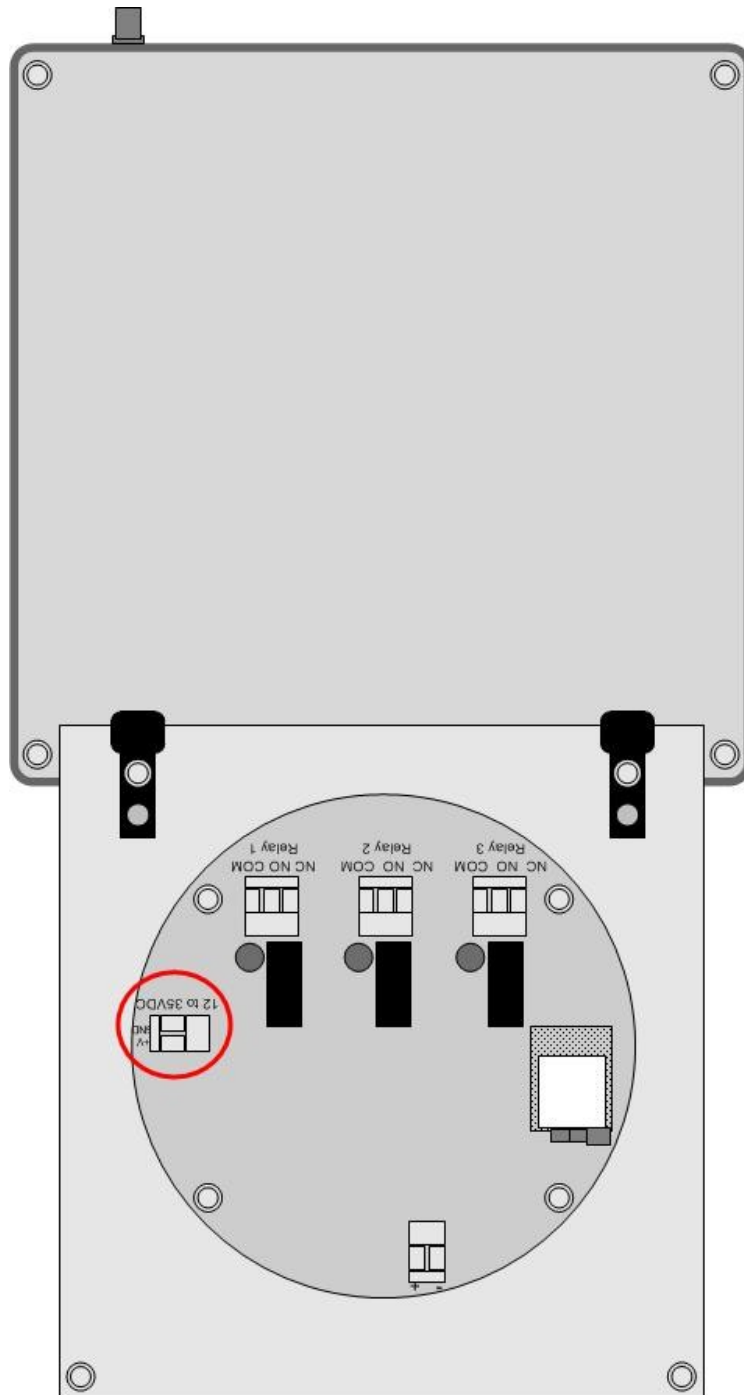

4. Connect a positive wire (red) to the terminal labeled “+V” on the Terminal Board's “12 to 35VDC” Terminal Block.
5. Connect the other end of the same positive wire (red) to a DC Power Supply.
6. Connect a negative wire (black) to the terminal labeled “GND” on the Terminal Board's “12 to 35VDC” Terminal Block.
7. Connect the other end of the same neutral wire (black) to the DC Power Supply.

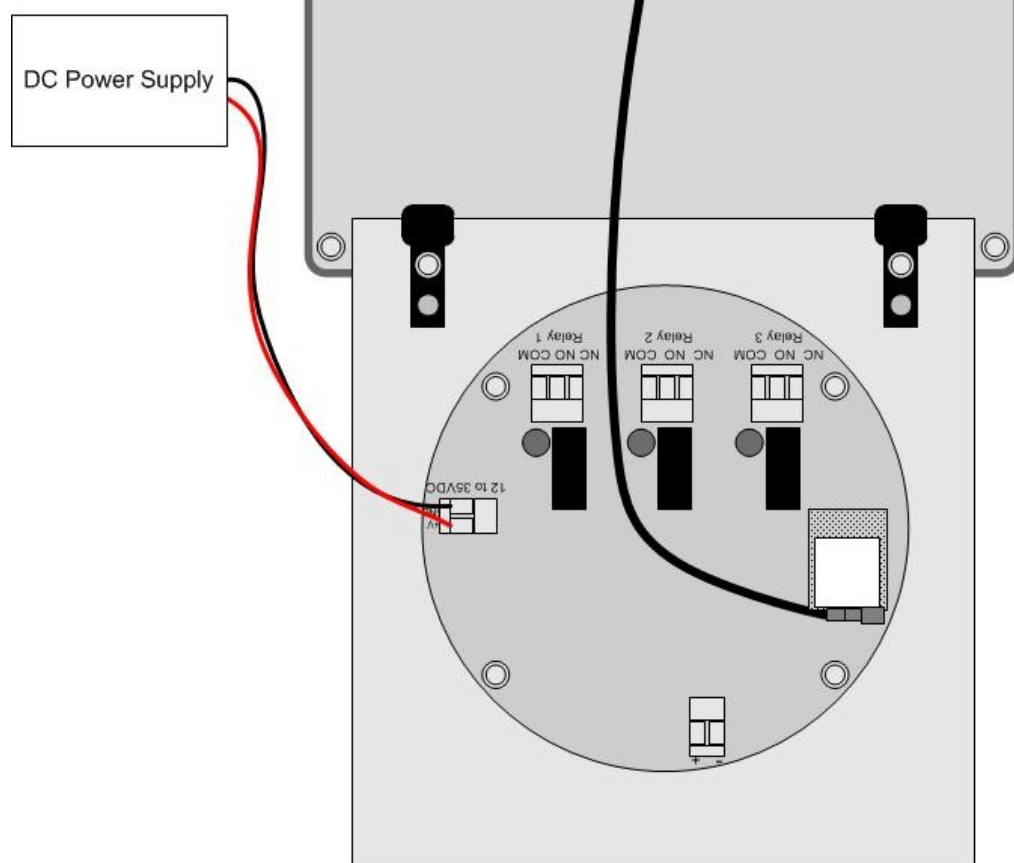

### Relay 1 (Low Alarm) Wiring Configurations

1. Locate the Relay 1 Terminal Block on the Terminal Board.

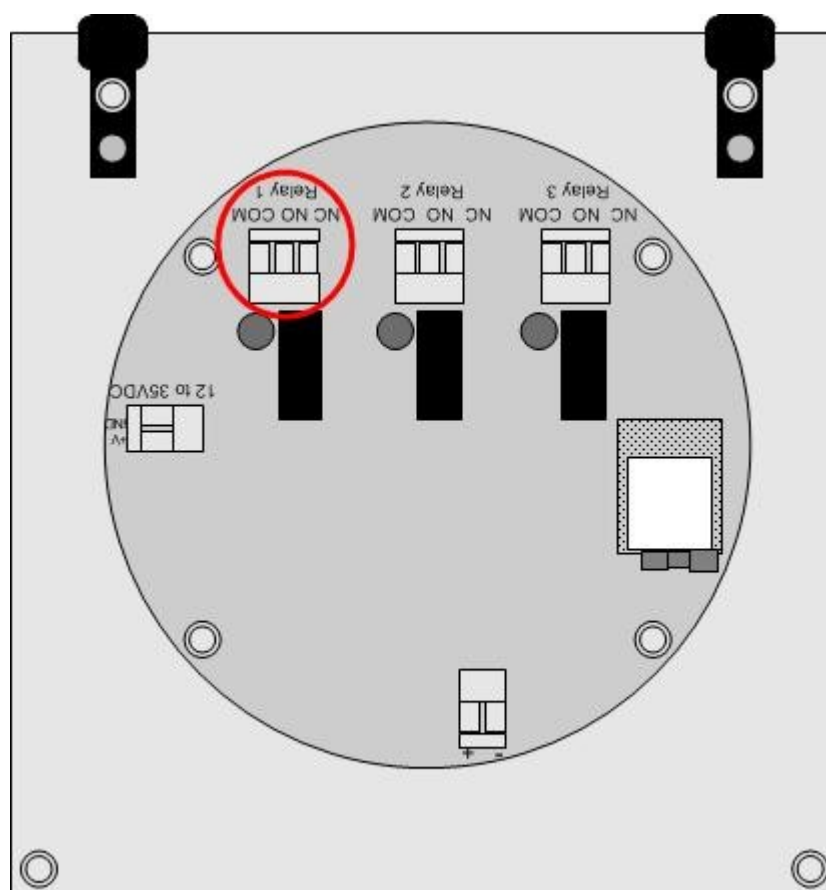

2. Connect a positive wire (red) from the terminal labeled "+V" on the Terminal Board's "12 to 35VDC" Terminal Block to the terminal labeled "COM" on the Relay 1 Terminal Block.
3. Connect the positive wire (red) from the Low Alarm to the terminal labeled "NO" (or "NC") on the Relay 1 Terminal Block.
4. Connect the neutral wire (black) from the Low Alarm to the DC Power Supply.
5. Once the Relay 1 Wiring Configurations are complete, proceed to the next section.

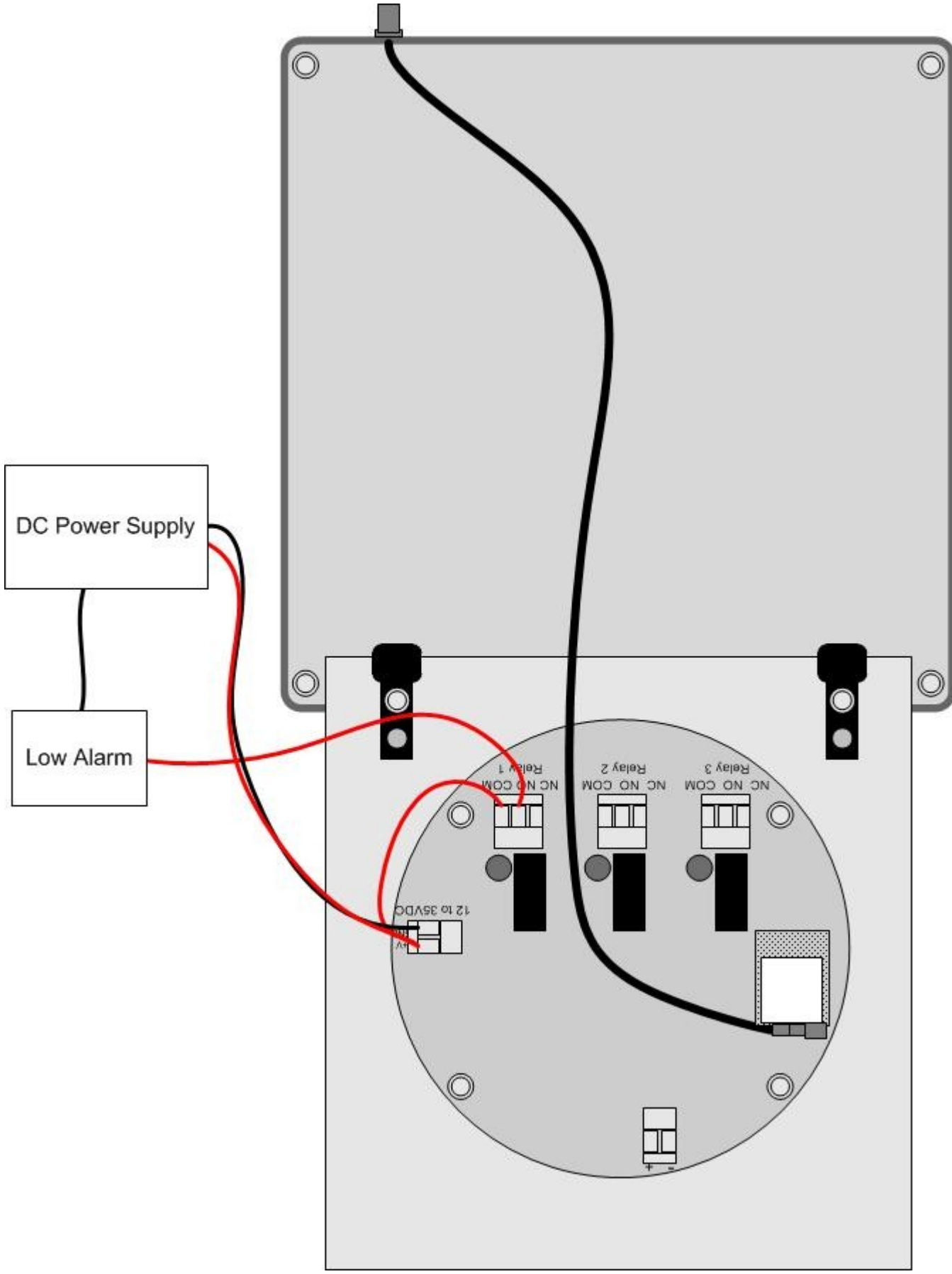

# Relay 2 (High Alarm) Wiring Configurations

- 1. After the Relay 1 Wiring Configurations have been completed (see previous section), locate the Relay 2 terminal block on the back of the Terminal Board.
- 2. Connect a jumper wire (blue) from the terminal labeled "COM" on the Relay 1 Terminal Block to the terminal labeled "COM" on the Relay 2 Terminal Block.
- 3. Connect the positive wire (red) from the High Alarm to the terminal labeled "NO" (or "NC") on the Relay 2 Terminal Block.
- 4. Connect the neutral wire (black) from the High Alarm to the DC Power Supply.
- 5. Once the Relay 2 Wiring Configurations are complete, proceed to the next section.

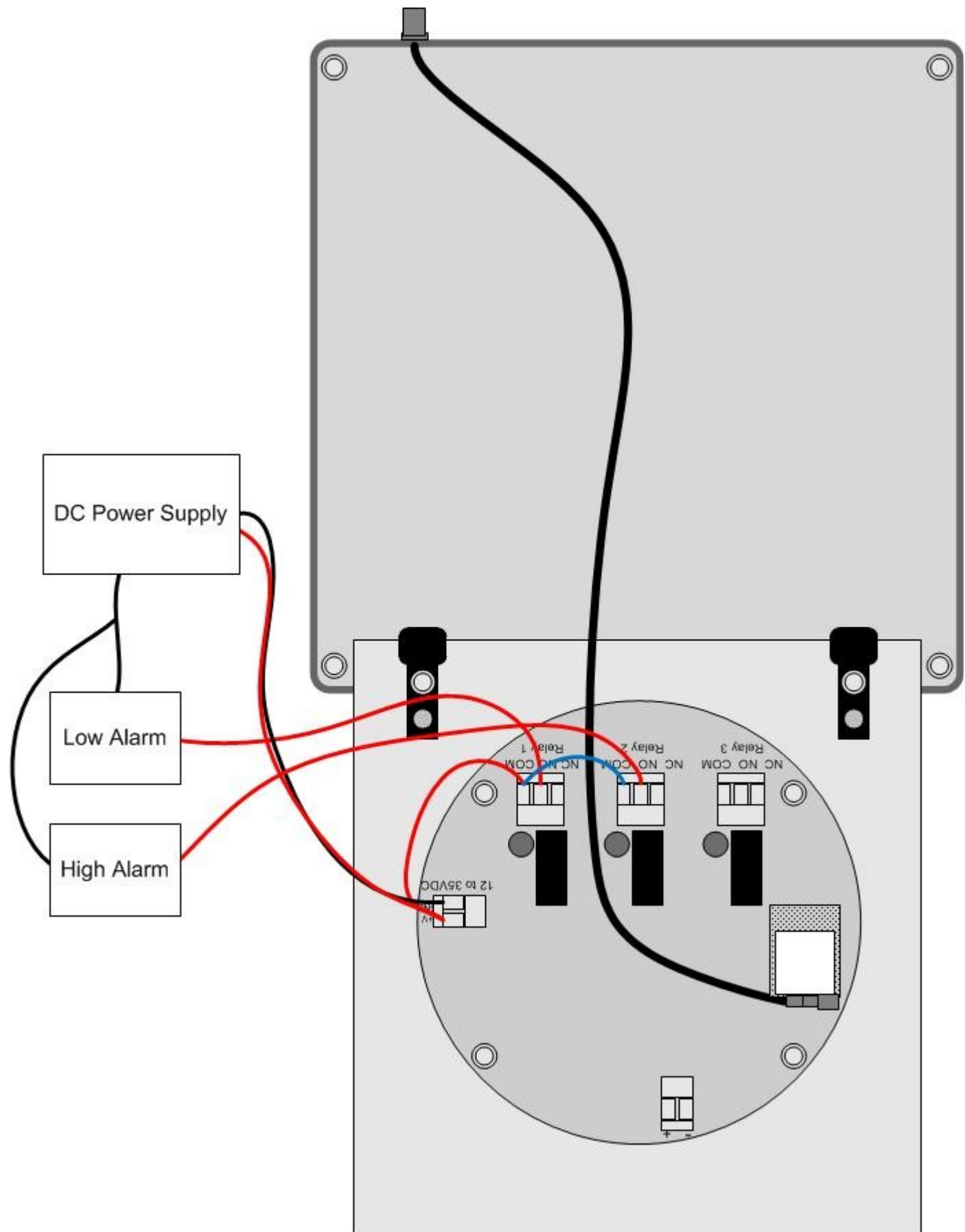
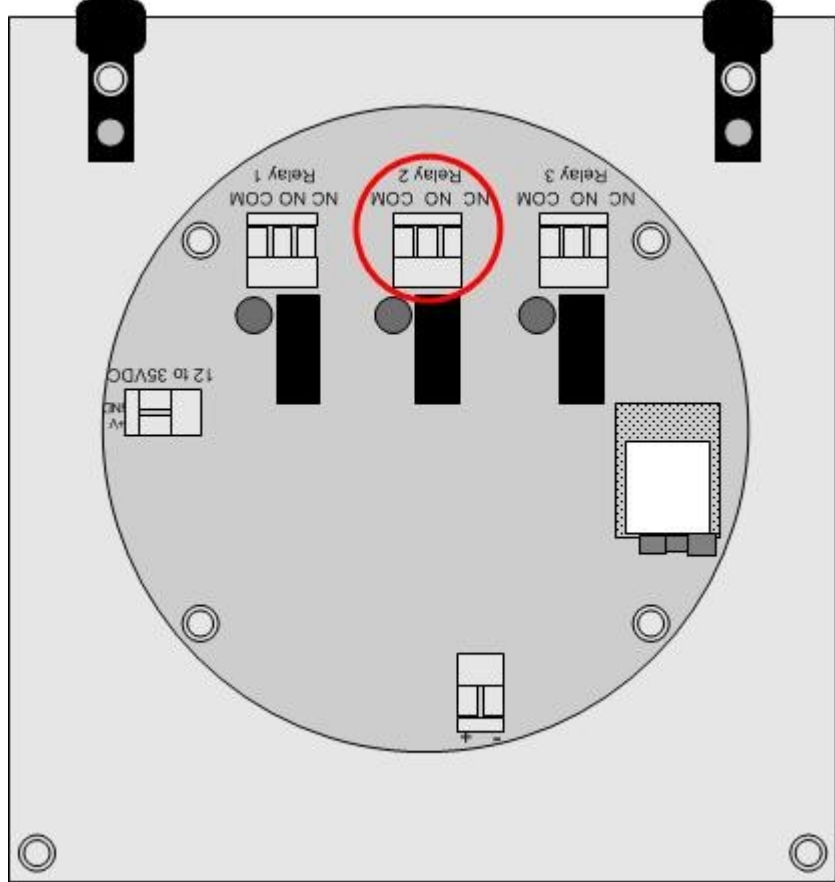

### Relay 3 (Danger) Wiring Configurations

1. After the Relay 2 Wiring Configurations have been completed (see previous section), locate the Relay 3 terminal block on the Terminal Board.
2. Connect a jumper wire (blue) from the terminal labeled “COM” on the Relay 2 Terminal Block to the terminal labeled “COM” on the Relay 3 Terminal Block.
3. Connect the positive wire (red) from the Danger Alarm to the terminal labeled “NO” (or “NC”) on the Relay 3 Terminal Block.
4. Connect the neutral wire (black) from the Danger Alarm to the DC Power Supply.
5. Close the Front Panel.
6. Screw in the Thumbscrews.
7. Close the Enclosure Box and Latch.
8. All DC Wiring Configurations are complete. Once power is supplied, the device will be fully functional and ready to operate.

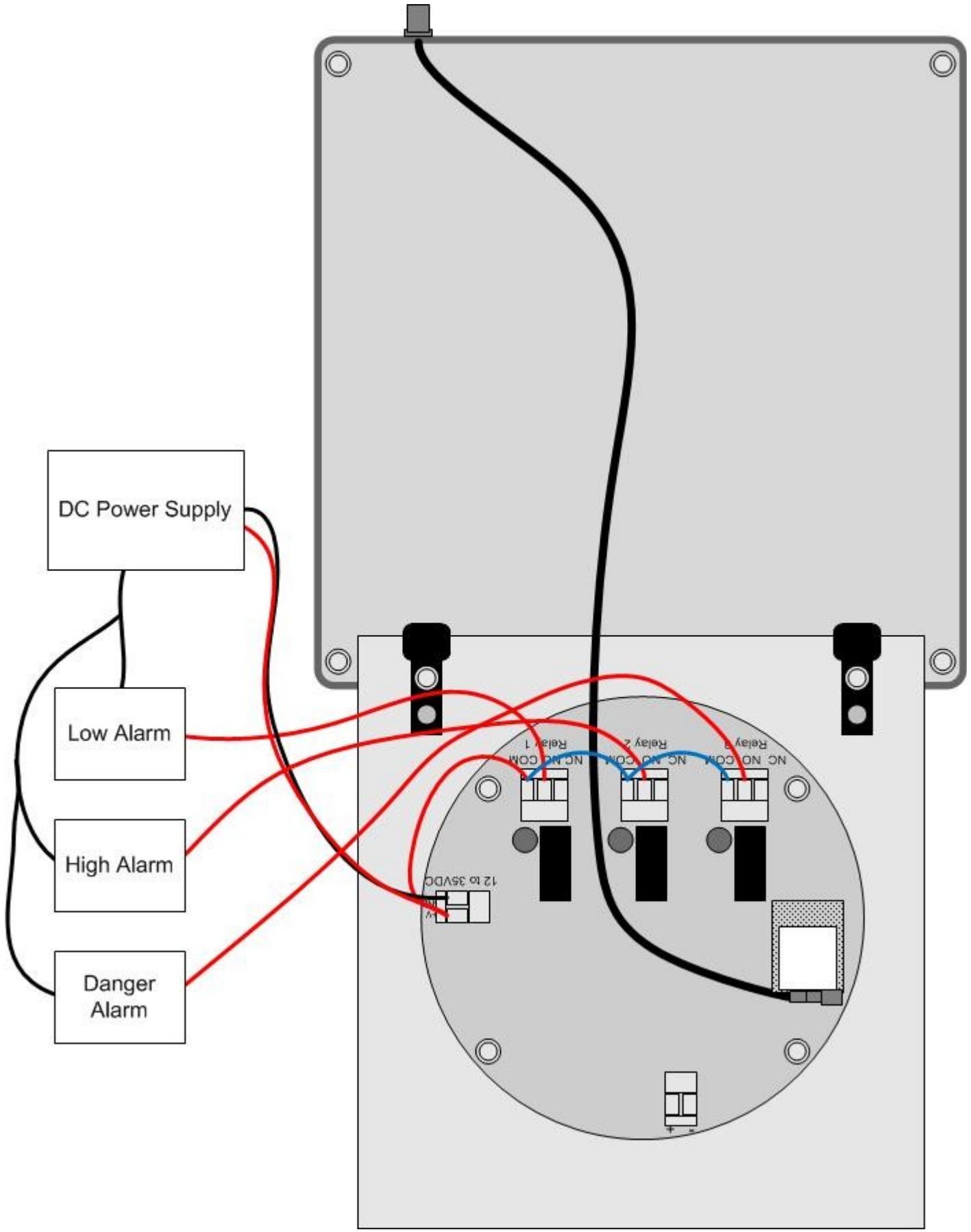
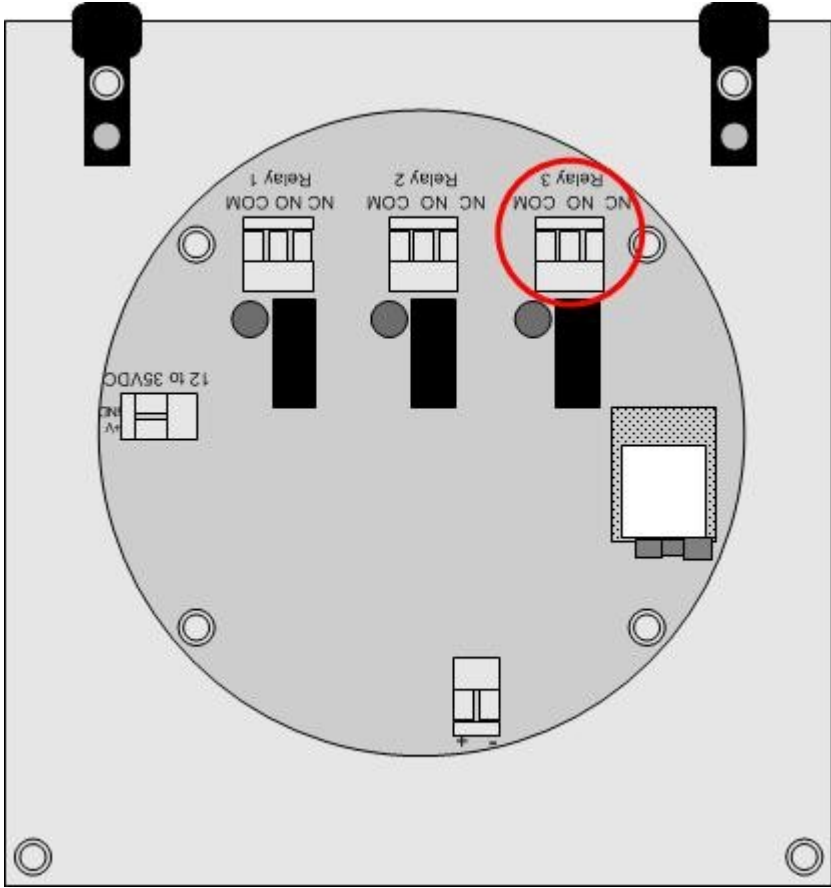



## APPENDIX C: OI-7543 Troubleshooting Guide

*NOTE: If a channel is in Fault, the display screen will show F(#).*

- Fault 1  
Indication: Sensor Housing Timeout  
Reason: OI-6000 digital sensor board problem  
Solution: Check connections; replace sensor housing if still in Fault

---

- Fault 4  
Indication: ADC Not Responding  
Reason: OI-6000 or OI-6900 analog sensor board not responding  
Solution: Ensure that the analog board is properly connected; replace analog sensor board if still in Fault

---

- Fault 8  
Indication: Two Sensors Same Add  
Solution: Check addresses of all sensors until the duplicate is found, then change the duplicated address

---

- Fault 9  
Indication: Sensor Radio Timeout  
Solution: Ensure that all WireFree sensors are in range and transmitting

---

- Fault 15  
Indication: Monitor Fault  
Reason: No Primary Monitor  
Solution: Set the OI-7543 (or another monitor) to be the Primary Monitor



## Specifications

<b>Supply Voltage:</b>	12-35 VDC or 120/240 Volts AC
<b>Temperature:</b>	-30 to 70° C
<b>Channels:</b>	4 channels w/ individually configurable set-points
<b>Relays:</b>	Three dry-contact (5 Amp) w/ 4 Amp fuses
<b>Radio Options:</b>	· 2.4 GHz ISM, 100mW · 900 MHz, 200mW
<b>Enclosure:</b>	8x8x4
<b>Warranty:</b>	Hardware: One year (Limited)

---

### Warranty Statement for The GenII WireFree OI-7543

#### Hardware

Otis Instruments, Inc. (Manufacturer) warrants its products to be free of defects in workmanship and materials—under normal use and service—from the date of purchase from the manufacturer or from the product's authorized reseller. The hardware for this device is under a one year limited warranty.

The manufacturer is not liable (under this warranty) if its testing and examination disclose that the alleged defect in the product does not exist or was caused by the purchaser's (or any third party's) misuse, neglect, or improper installation, testing or calibrations. Any unauthorized attempt to repair or modify the product, or any other cause of damage beyond the range of the intended use, including damage by fire, lightening, water damage or other hazard, voids liability of the manufacturer.

In the event that a product should fail to perform up manufacturer specifications during the applicable warranty period, contact the product's authorized reseller or return the product directly to the manufacturer with a Return Material Authorization (RMA). This number will be assigned upon contacting customer service at 979.776.7700 or [Otis@otisinstruments.com](mailto:Otis@otisinstruments.com). The manufacturer will--at its option and expense--repair or replace the product, or deliver an equivalent product or part to the purchaser at no additional charge.

Any replaced or repaired product or part has either a 90-day warranty or the remainder of the initial warranty period (whichever is longer).



**Otis Instruments, Inc.**

*Corporate Office*  
2200 E. Villa Maria Dr.  
Bryan, TX 77802  
979.776.7700  
[www.otisinstruments.com](http://www.otisinstruments.com)