

Use & Care Manual

Over The Range Convection Microwave Oven

Models **PCOR30B, PCOR30R, PCOR30S**



IMPORTANT INFORMATION

- ◆ Operation Instructions
- ◆ Cooking Guides
- ◆ Specifications

Please Read Before Using Your Microwave Oven

dacor[®]
The life of the kitchen™

FOR CUSTOMER ASSISTANCE

To aid in reporting this microwave oven in case of loss or theft, please record below the model number and serial number located on the unit. We also suggest you record all the information listed and retain for future reference.

MODEL NUMBER _____	SERIAL NUMBER _____
DATE OF PURCHASE _____	
DEALER _____	TELEPHONE _____
SERVICER _____	TELEPHONE _____

TO PHONE: 1(800)793-0093

TO WRITE: DACOR INC.
1440 Bridge Gate Drive
Diamond Bar, CA 91765

Please provide the following information when you write or call: model number, serial number, date of purchase, your complete mailing address (including zip code), your daytime telephone number (including area code) and description of the problem.

TO ACCESS INTERNET: www.dacor.com

PRECAUTIONS TO AVOID POSSIBLE EXPOSURE TO EXCESSIVE MICROWAVE ENERGY

- (a) Do not attempt to operate this oven with the door open since open-door operation can result in harmful exposure to microwave energy. It is important not to defeat or tamper with the safety interlocks.
- (b) Do not place any object between the oven front face and the door or allow soil or cleaner residue to accumulate on sealing surfaces.
- (c) Do not operate the oven if it is damaged. It is particularly important that the oven door close properly and that there is no damage to the: (1) door (bent), (2) hinges and latches (broken or loosened), (3) door seals and sealing surfaces.
- (d) The oven should not be adjusted or repaired by anyone except properly qualified service personnel.

CONTENTS

For Customer Assistance	2	Sensor Cook Chart	17
Precautions to Avoid Possible Exposure to Excessive Microwave Energy	2	Sensor Cook Recipes	18-19
Contents	3	Manual Convection /Automatic Mix Operation	20-24
Product Limited Warranty	4	Convection Cooking	20
Important Safety Instructions	5	To Cook with Convection	20
Unpacking Instructions	6	To Preheat and Cook with Convection	20
Grounding Instructions	6	To Broil	20
Information You Need to Know	7-9	To Slow Cook	21
About Your Oven	7	Automatic Mix Cooking	21
About Food	7	To Cook with Automatic Mix	21
About Microwave Cooking	8	To Preheat and Cook with Automatic Mix	21
About Safety	8	Convection Automatic Mix Operation	22-24
About Children and the Microwave	8	Auto Broil	22
About Utensils and Coverings	9	Auto Broil Chart	22
Part Names	10	Auto Roast	23
Control Panel	11	Auto Roast Chart	23
Before Operating	12	Auto Bake	24
To Set the Clock	12	Auto Bake Chart	24
Stop/Clear	12	Other Convenient Features	25-26
Manual Microwave Operation	12-13	Multiple Sequence Cooking	25
Turntable On/Off	12	More/Less Time Adjustment	25
Hood Light/Hood Fan	13	Kitchen Timer	25
Time Cooking Microwave	13	Easy Minute	25
Keep Warm	13	Demonstration Mode	25
To Set Power Level	13	Help	25
Microwave Features	14-19	Help Guide	26
Auto Defrost	14	1. Child Lock	26
Auto Defrost Chart	14	2. Audible Signal Elimination	26
Manual Defrost	15	3. Auto Start	26
Sensor Cooking	15	4. Language Selection	26
Instant Sensors	16	5. Weight/Temp Selection	26
Instant Sensor Reheat	16	Instant On	26
Instant Sensor Popcorn	16	Cleaning and Care	27-28
Popcorn Chart	16	Service Call Check	29
Instant Sensor Chart	16	Specifications	29
Sensor Cook	17	Quick Reference	30

INTERACTIVE COOKING SYSTEM

The Interactive Cooking System offers step-by-step instructions in the display for using the oven, from setting the clock to programming each feature. It also includes Help Guide for instructions on using Child Lock, Audible Signal Elimination, Auto Start and Help. There is a choice of English, Spanish or French and a choice of U.S. Customary Unit-pound or Metric-kilograms. Touch HELP GUIDE and follow the directions displayed or check page 26.

PRODUCT WARRANTY

WHAT IS COVERED

CERTIFICATE OF WARRANTIES

DACOR MICROWAVE OVEN

WITHIN THE FIFTY STATES OF THE U.S.A., THE DISTRICT OF COLUMBIA AND CANADA*:

FULL ONE YEAR WARRANTY

If your DACOR product fails to function within one year of the original date of purchase, due to a defect in material or workmanship, DACOR will remedy the defect without charge to you or subsequent users. The owner must provide proof of purchase upon request and have the appliance accessible for service.

* Warranty is null and void if non-CSA approved product is transported from the U.S.

OUTSIDE THE FIFTY STATES OF THE U.S.A., THE DISTRICT OF COLUMBIA AND CANADA:

LIMITED FIRST YEAR WARRANTY

If your DACOR product fails to function within one year of the original date of purchase, due to a defect in material or workmanship, DACOR will furnish a new part, F.O.B. factory, to replace the defective part. All delivery, installation and labor costs are the responsibility of the purchaser. The owner must provide proof of purchase upon request and have the appliance accessible for service.

WHAT IS NOT COVERED

- Failure of the product caused by faulty installation, improper usage, or neglect of required maintenance.
- Service calls to educate the customer in the proper use and care of the product.
- Failure of the product when used for commercial, business, rental or any application other than for residential consumer use.
- Replacement of house fuses or fuse boxes, or resetting of circuit breakers.
- Damage to the product caused by accident, fire, flood or other acts of God.
- Breakage, discoloration or damage to glass, metal surfaces, plastic components, trim, paint, porcelain or other cosmetic finish, caused by improper usage or care, abuse, or neglect.

THE REMEDIES PROVIDED FOR IN THE ABOVE EXPRESS WARRANTIES ARE THE SOLE AND EXCLUSIVE REMEDIES THEREFORE NO OTHER EXPRESS WARRANTIES ARE MADE, AND OUTSIDE THE FIFTY STATES OF THE UNITED STATES AND THE DISTRICT OF COLUMBIA, ALL IMPLIED WARRANTIES, INCLUDING BUT NOT LIMITED TO , ANY IMPLIED WARRANTY OF MERCHANTABILITY OR FITNESS FOR A PURCHASE. IN NO EVENT SHALL DACOR BE LIABLE FOR INCIDENTAL EXPENSE OR CONSEQUENTIAL DAMAGES NO WARRANTIES, EXPRESS OR IMPLIED, ARE MADE TO ANY BUYER FOR RESALE.

Some states do not allow limitations on how long an implied warranty lasts or do not allow the exclusion or limitation of incidental or consequential damages, so the above limitations or exclusions may not apply to you. This warranty gives you specific legal rights, and you may also have other rights that vary from state to state.

IMPORTANT SAFETY INSTRUCTIONS

When using electrical appliances basic safety precautions should be followed, including the following:

WARNING - To reduce the risk of burns, electric shock, fire, injury to persons or exposure to excessive microwave energy:

1. Read all instructions before using the appliance.
2. Read and follow the specific **“PRECAUTIONS TO AVOID POSSIBLE EXPOSURE TO EXCESSIVE MICROWAVE ENERGY”** on inside front cover.
3. This appliance must be grounded. Connect only to properly grounded outlet. See **“GROUNDING INSTRUCTIONS”** on page 6 and INSTALLATION INSTRUCTIONS.
4. Install or locate this appliance only in accordance with the provided installation instructions.
5. Some products such as whole eggs and sealed containers—for example, closed glass jars—may explode and should not be heated in this oven.
6. Stir liquids briskly before and after heating to avoid eruption.
7. Use this appliance only for its intended use as described in this manual. Do not use corrosive chemicals or vapors in this appliance. This type of oven is specifically designed to heat, cook or dry food. It is not designed for industrial or laboratory use.
8. As with any appliance, close supervision is necessary when used by children.
9. Do not operate this appliance if it has a damaged cord or plug, if it is not working properly or if it has been damaged or dropped.
10. This appliance should be serviced only by qualified service personnel. Contact nearest Dacor Authorized Servicer for examination, repair or adjustment.
11. Do not cover or block any openings on the appliance.
12. Do not store or use this appliance outdoors. Do not use this product near water—for example, near a kitchen sink, in a wet basement or near a swimming pool, and the like.
13. Do not immerse cord or plug in water.
14. Keep cord away from heated surfaces.
15. Do not let cord hang over edge of table or counter.
16. See door surface cleaning instructions on page 27.
17. To reduce the risk of fire in the oven cavity:
 - a. Do not overcook food. Carefully attend appliance if paper, plastic or other combustible materials are placed inside the oven to facilitate cooking.
 - b. Remove wire twist-ties from paper or plastic bags before placing bag in oven.
 - c. **If materials inside the oven should ignite, keep oven door closed, turn oven off and disconnect the power cord or shut off power at the fuse or circuit breaker panel.**
 - d. Do not use the cavity for storage purposes. Do not leave paper products, cooking utensils or food in the cavity when not in use.
18. Clean ventilation openings and grease filters frequently—Grease should not be allowed to accumulate on ventilation openings, hood (louver) or grease filters.
19. Use care when cleaning the louver and the grease filters. Corrosive cleaning agents, such as lye-based oven cleaners, may damage the louver and the grease filters.
20. When flaming food under the hood, turn the fan on.
21. This appliance is suitable for use above both gas and electric cooking equipment 36” wide or less.

SAVE THESE INSTRUCTIONS

UNPACKING INSTRUCTIONS

Unpacking and Examining Your Oven

Carefully remove oven from carton. **SAVE THE CARTON AS IT MAY MAKE INSTALLATION EASIER.**

Remove:

1. all packing materials from inside the oven cavity; however, **DO NOT REMOVE THE WAVEGUIDE COVER**, which is located on the ceiling in the oven cavity. Check to see that there are Installation Instructions, Wall Template and Top Template. Read enclosures and **SAVE** the Operation Manual.
2. the feature sticker from the outside of the door, if there is one.

Check the oven for any damage, such as misaligned or bent door, damaged door seals and sealing surfaces, broken or loose door hinges and latches and dents inside the cavity or on the door. If there is any damage, do not operate the oven and contact your dealer or **DACOR AUTHORIZED SERVICER**.

See Installation Instructions for more details.

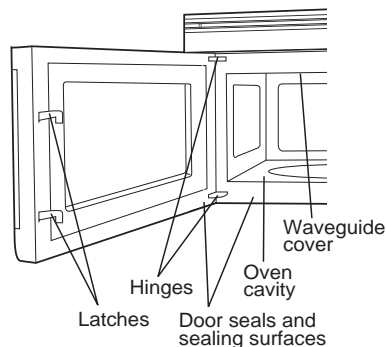

GROUNDING INSTRUCTIONS

This appliance must be grounded. This oven is equipped with a cord having a grounding wire with a grounding plug. It must be plugged into a wall receptacle that is properly installed and grounded in accordance with the National Electrical Code and local codes and ordinances. In the event of an electrical short circuit, grounding reduces risk of electric shock by providing an escape wire for the electric current.

WARNING – Improper use of the grounding plug can result in a risk of electric shock.

Electrical Requirements

Check Installation Instructions for proper location for the power supply.

The electrical requirements are a 120 volt 60 Hz, AC only, 15 amp. or more protected electrical supply. It is recommended that a separate circuit serving only the oven be provided.

The oven is equipped with a 3-prong grounding plug. It must be plugged into a wall receptacle that is properly installed and grounded. **DO NOT UNDER ANY CIRCUMSTANCES CUT OR REMOVE THE GROUNDING PIN FROM THE PLUG.**

Notes: 1. If you have any questions about the grounding or electrical instructions, consult a qualified electrician or service person.

2. Neither Dacor nor the dealer can accept any liability for damage to the oven or personal injury resulting from failure to observe the correct electrical connection procedures.

Radio or TV Interference

Should there be any interference caused by the microwave oven to your radio or TV, check that the microwave oven is on a different electrical circuit, relocate the radio or TV as far away from the oven as feasible or check position and signal of receiving antenna.

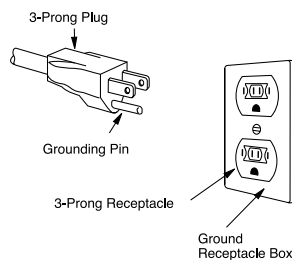

INFORMATION YOU NEED TO KNOW

ABOUT YOUR OVEN

This Operation Manual is valuable: read it carefully and always save it for reference.

A good microwave cookbook is a valuable asset. Check it for microwave cooking principles, techniques, hints and recipes.

NEVER use the oven without the turntable and support nor turn the turntable over so that a large dish could be placed in the oven. The turntable will turn both clockwise and counterclockwise. See page 12 for complete instructions.

ALWAYS have food in the oven when it is on to absorb the microwave energy.

When using the oven at power levels below 100%, you may hear the magnetron cycling on and off.

The fan will automatically start when heat rises from range surface units or burners and when convection, high mix, low mix or the broil settings are used.

Condensation is a normal part of microwave cooking. Room humidity and the moisture in food will influence the amount of moisture that condenses in the oven. Generally, covered foods will not cause as much condensation as uncovered ones. Ventilation openings must not be blocked.

The oven is for food preparation only. It should not be used to dry clothes or newspapers.

Your oven is rated 850 watts by using the IEC Test Procedure. In using recipes or package directions, check food a minute or two before the minimum time and add time accordingly.

ABOUT FOOD

FOOD	DO	DON'T
Eggs, sausages, fruits & vegetables	<ul style="list-style-type: none"> Puncture egg yolks before cooking to prevent "explosion". Pierce skins of potatoes, apples, squash, hot dogs and sausages so that steam escapes. 	<ul style="list-style-type: none"> Cook eggs in shells. Reheat whole eggs. Dry nuts or seeds in shells.
Popcorn	<ul style="list-style-type: none"> Use specially bagged popcorn for the microwave oven. Listen while popping corn for the popping to slow to 1 or 2 seconds or use special POPCORN pad. 	<ul style="list-style-type: none"> Pop popcorn in regular brown bags or glass bowls. Exceed maximum time on popcorn package.
Baby food	<ul style="list-style-type: none"> Transfer baby food to small dish and heat carefully, stirring often. Check temperature before serving. Put nipples on bottles after heating and shake thoroughly. "Wrist" test before feeding. 	<ul style="list-style-type: none"> Heat disposable bottles. Heat bottles with nipples on. Heat baby food in original jars.
General	<ul style="list-style-type: none"> Cut baked goods with filling after heating to release steam and avoid burns. Stir liquids briskly before and after heating to avoid "eruption". Use deep bowl, when cooking liquids or cereals, to prevent boilovers. 	<ul style="list-style-type: none"> Heat or cook in closed glass jars or air tight containers. Can in the microwave as harmful bacteria may not be destroyed. Deep fat fry. Dry wood, gourds, herbs or wet papers.

INFORMATION YOU NEED TO KNOW

ABOUT MICROWAVE COOKING

- Arrange food carefully. Place thickest areas towards outside of dish.
- Watch cooking time. Cook for the shortest amount of time indicated and add more as needed. Food severely overcooked can smoke or ignite.
- Cover foods while cooking. Check recipe or cookbook for suggestions: paper towels, wax paper, microwave plastic wrap or a lid. Covers prevent spattering and help foods to cook evenly.
- Shield with small flat pieces of aluminum foil any thin areas of meat or poultry to prevent overcooking before dense, thick areas are cooked thoroughly.
- Stir foods from outside to center of dish once or twice during cooking, if possible.
- Turn foods over once during microwaving to speed cooking of such foods as chicken and hamburgers. Large items like roasts must be turned over at least once.
- Rearrange foods such as meatballs halfway through cooking both from top to bottom and from the center of the dish to the outside.
- Add standing time. Remove food from oven and stir, if possible. Cover for standing time which allows the food to finish cooking without overcooking.
- Check for doneness. Look for signs indicating that cooking temperatures have been reached.

Doneness signs include:

- Food steams throughout, not just at edge.
- Center bottom of dish is very hot to the touch.
- Poultry thigh joints move easily.
- Meat and poultry show no pinkness.
- Fish is opaque and flakes easily with a fork.

ABOUT SAFETY

- Check foods to see that they are cooked to the United States Department of Agriculture's recommended temperatures.
- ALWAYS use potholders to prevent burns when handling utensils that are in contact with hot food. Enough heat from the food can transfer through utensils to cause skin burns.
- Avoid steam burns by directing steam away from the face and hands. Slowly lift the farthest edge of a dish's covering and carefully open popcorn and oven cooking bags away from the face.
- Stay near the oven while it's in use and check cooking progress frequently so that there is no chance of overcooking food.
- NEVER use the cavity for storing cookbooks or other items.
- Select, store and handle food carefully to preserve its high quality and minimize the spread of foodborne bacteria.
- Keep waveguide cover clean. Food residue can cause arcing and/or fires.
- Use care when removing items from the oven so that the utensil, your clothes or accessories do not touch the safety door latches.

TEMP	FOOD
160°F	... for fresh pork, ground meat, boneless white poultry, fish, seafood, egg dishes and frozen prepared food.
165°F	... for leftover, ready-to-reheat refrigerated, and deli and carry-out "fresh" food.
170°F	... white meat of poultry.
180°F	... dark meat of poultry.

To test for doneness, insert a meat thermometer in a thick or dense area away from fat or bone. NEVER leave the thermometer in the food during cooking, unless it is approved for microwave oven use.

ABOUT CHILDREN AND THE MICROWAVE

Children below the age of 7 should use the microwave oven with a supervising person very near to them. Between the ages of 7 and 12, the supervising person should be in the same room.

The child must be able to reach the oven comfortably; if not, he/she should stand on a sturdy stool.

At no time should anyone be allowed to lean or swing on the oven door.

Children should be taught all safety precautions: use potholders, remove coverings carefully, pay special attention to packages that crisp food because they may be extra hot.

Don't assume that because a child has mastered one cooking skill he/she can cook everything.

Children need to learn that the microwave oven is not a toy. See page 26 for Child Lock feature.

INFORMATION YOU NEED TO KNOW

ABOUT UTENSILS AND COVERINGS

It is not necessary to buy all new cookware. Many pieces already in your kitchen can be used successfully in your new microwave convection oven. The chart below will help you decide what utensils and coverings should be used in each mode.

UTENSILS AND COVERINGS	MICROWAVE ONLY	CONVECTION BROIL, SLOW COOK	HIGH MIX/ROAST LOW MIX/BAKE
Aluminum Foil	Yes Small flat pieces of aluminum foil placed smoothly on food can be used to shield areas from cooking or defrosting too quickly. Keep foil at least 1 inch from wall of oven.	Yes For shielding.	Yes For shielding.
Aluminum containers	Yes Can be used if 3/4 filled with food. Keep 1 inch away from walls and do not cover with lid.	Yes Broil - No cover.	Yes Can be used if 3/4 filled with food. Keep 1 inch away from walls and do not cover with foil.
Browning dish	Yes Do not exceed recommended preheating time. Follow manufacturer's directions.	No	No
Glass ceramic (Pyroceram®)	Yes Excellent.	Yes Excellent.	Yes Excellent.
Glass, heat-resistant	Yes Excellent	Yes Excellent	Yes Excellent
Glass, non-heat-resistant	No	No	No
Lids, glass	Yes	Yes Broil - No cover.	Yes
Lids, metal	No	Yes Broil - No cover.	No
Metal cookware	No	Yes	Yes Do not use metal coverings.
Metal, misc: dishes with metallic trim, etc. Metal twist-ties.	No	No	No
Oven cooking bags	Yes Good for large meats or foods that need tenderizing. DO NOT use metal twist ties.	Yes Broil - No	Yes Do not use metal coverings.
Paper plates	Yes For reheating.	No	No
Paper towels	Yes To cover for reheating and cooking. Do not use recycled paper towels which may contain metal filings.	No	No
Paper, ovenable	Yes	Yes For temperatures up to 400°F. Do not use for broiling.	Yes For temperatures up to 400°F.
Microwave-safe plastic containers	Yes Use for reheating and defrosting. Follow manufacturer's directions.	No	No
Plastic, Thermoset®	Yes	Yes Are heat resistant up to 425°F. Do not use for broiling.	Yes
Plastic wrap	Yes Use brands specially marked for microwave use. DO NOT allow plastic wrap to touch food. Vent so steam can escape.	No	No
Pottery, stoneware, porcelain	Yes Check manufacturer's recommendation for being microwave-safe.	Yes	Yes Must be microwave-safe and ovenable.
Styrofoam	Yes For reheating	No	No
Wax paper	Yes Good covering for cooking and reheating.	No	No
Wicker, wood, straw	Yes May be used for short periods of time. Do not use with high fat or high sugar content foods. Could char.	No	No

DISH CHECK. If you wish to check if a dish is safe for microwaving, place the empty dish in the oven and microwave on HIGH for 30 seconds. If the dish becomes very hot, DO NOT use it for microwaving.

ACCESSORIES There are many microwave accessories available for purchase. Evaluate carefully before you purchase so that they meet your needs. A microwave-safe thermometer will assist you in determining correct doneness and assure you that foods have been cooked to safe temperatures. Dacor is not responsible for any damage to the oven when accessories are used.

PART NAMES

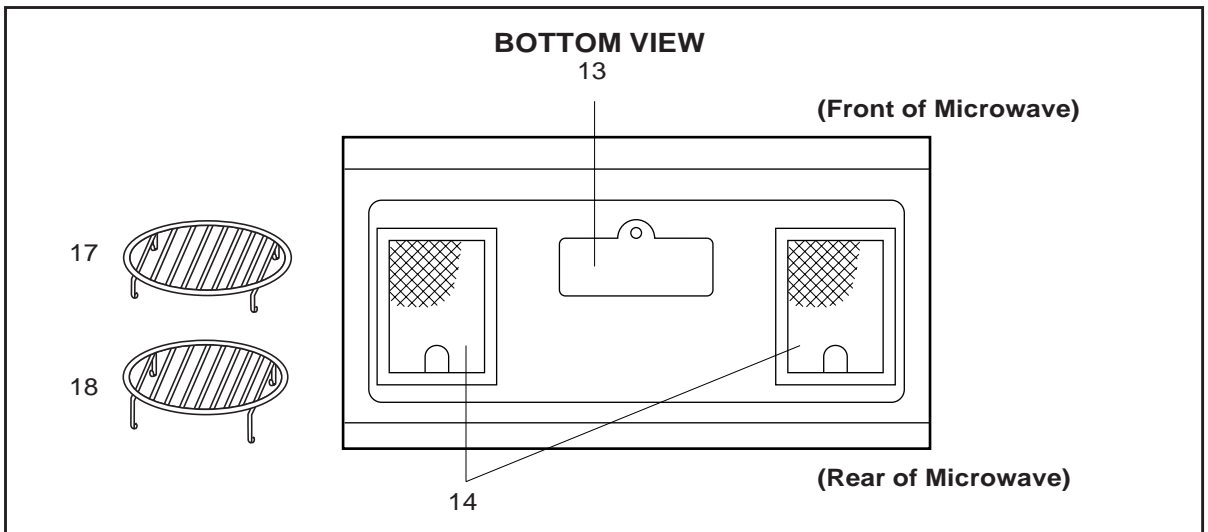
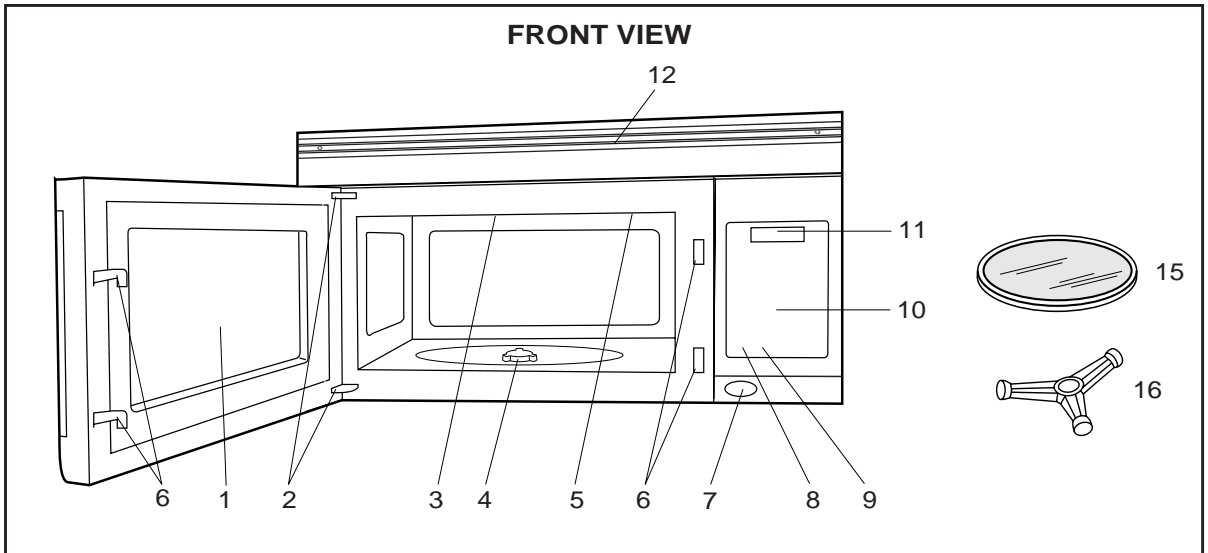

- | | |
|--|--|
| <ul style="list-style-type: none"> 1. Oven door with see-through window. 2. Door hinges. 3. Waveguide cover
DO NOT REMOVE. 4. Turntable motor shaft. 5. Oven light.
It will light when oven is operating or door is open. 6. Safety door latches.
The oven will not operate unless the door is securely closed. 7. One touch DOOR OPEN button.
Push to open door. 8. FAN HI / LO button.
Push for high/low/off. 9. LIGHT button.
Push for on/off. | <ul style="list-style-type: none"> 10. Auto-Touch control panel. 11. Time display: Digital display, 99 minutes 99 seconds. 12. Ventilation openings. 13. Light cover. 14. Grease filters. 15. Removable ceramic turntable.
The turntable will rotate clockwise or counterclockwise. Only remove for cleaning. 16. Removable turntable support.
Place the turntable support on the floor of the oven cavity and the turntable on the turntable support. 17. Removable low rack for broiling and meat and poultry roasting. 18. Removable high rack for two level baking. |
|--|--|

CONTROL PANEL

INTERACTIVE DISPLAY



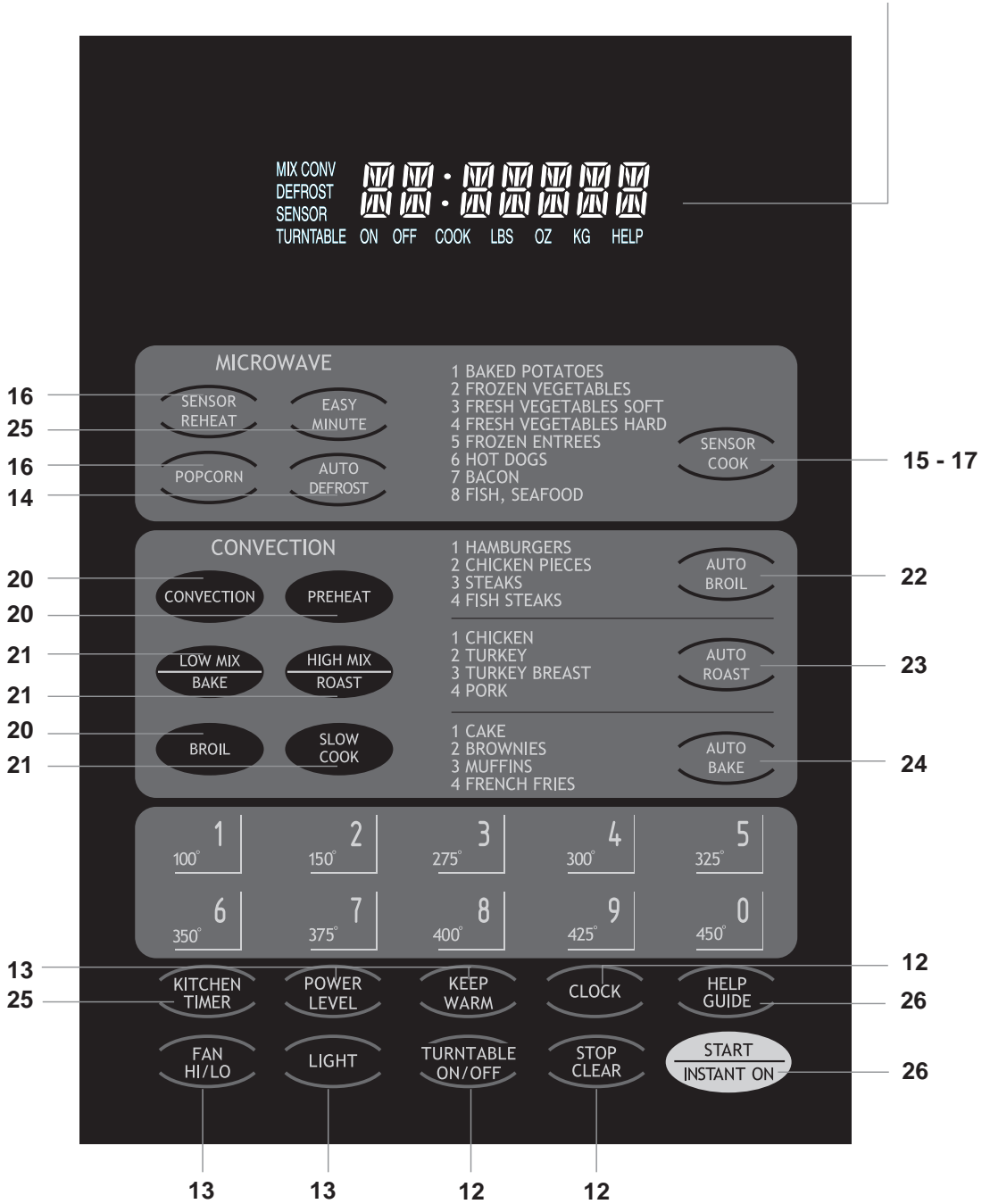



Words will light in the display to indicate features and cooking instructions.



Number next to the control panel illustration indicates page on which there are feature descriptions and usage information.







BEFORE OPERATING

- Before operating your new microwave oven make sure you read and understand this operation manual completely.
- Before the oven can be used, follow these procedures:

1. Plug in the oven. Close the door. The oven display will show    
 .
2. Touch the **STOP/CLEAR** pad.
 will appear.
3. Touch **CLOCK** and follow directions to set.

TO SET THE CLOCK

- Suppose you want to enter the correct time of day 12:30 (A.M. or P.M.).

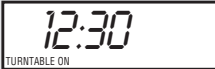
PROCEDURE	DISPLAY
1  Touch CLOCK pad.	 <small>TURNTABLE ON</small>  <small>TURNTABLE ON</small>
2     Enter the correct time of day by touching the numbers in sequence.	 <small>TURNTABLE ON</small>

3

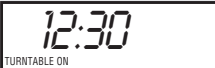

TURNTABLE ON

Touch **CLOCK** pad.

This is a 12 hour clock. If you attempt to enter an incorrect clock time,  will appear in the display. Touch the **STOP/CLEAR** pad and re-enter the time.

- If the electrical power supply to your microwave oven should be interrupted, the display will intermittently show  after the power is reinstated. If this occurs during cooking, the program will be erased. The time of day will also be erased. Simply touch **STOP/CLEAR** pad and reset the clock for the correct time of day.

NOTE: Your oven can be programmed with the door open except for **START/INSTANT ON**, **EASY MINUTE**, **SENSOR REHEAT** and **POPCORN**.

STOP/CLEAR

Touch the **STOP/CLEAR** pad to:













1. Erase if you make a mistake during programming.
2. Cancel kitchen timer.
3. Stop the oven temporarily during cooking.
4. Return the time of day to the display.
5. Cancel a program during cooking, touch twice.

MANUAL MICROWAVE OPERATION

TURNTABLE ON/OFF

For most cooking, the turntable should be on; however the turntable can be turned off so that it does not rotate when extra large dishes, such as the popular 13"x9"x2" glass utility casserole, are used. The casserole should be placed on the turntable so that it is level.

- Suppose you want to cook lasagna in a 13"x9"x2" casserole for 45 minutes on 40% power.

PROCEDURE	DISPLAY
1  Touch TURNTABLE ON/OFF pad and note TURNTABLE OFF in the display.	 <small>TURNTABLE OFF</small>
2     Enter cooking time.	 <small>TURNTABLE OFF</small>
3   Enter power level.	 <small>TURNTABLE OFF</small>
4  Touch START/INSTANT ON pad.	 <small>TURNTABLE OFF COOK</small>

NOTE:

The door can be opened for checking food and the turntable will stay in the off position. After checking, close door and touch **START/INSTANT ON**.

The turntable will stay off for one minute after door is opened when time-of-day appears in the display. It is possible to reprogram the oven during that minute without touching the **TURNTABLE ON/OFF** pad. The display always indicates whether the turntable is off or on.

THE TURNTABLE SHOULD ALWAYS BE ON WHEN USING THE SPECIAL FEATURES. On/Off function can be used with manual cooking modes and Sensor Reheat. Turntable off condition will automatically change to on condition when you select auto cooking except Sensor Reheat and Auto Bake.

When cooking large quantities of food which cannot be stirred, it is best to use a lower power level such as 40 or 50%. You may speed cooking of large amounts by programming 5 to 10 minutes on 100% power (HIGH) followed by the desired time on lower power. See page 25 for how to program multiple sequences. You may wish to reverse a large casserole once during cooking; simply open door, reposition casserole, close door and touch **START/INSTANT ON**.

MANUAL MICROWAVE OPERATION

HOOD LIGHT/ HOOD FAN

Your oven is equipped with a Hood Light and a Hood Fan which can be used whether the door is open or closed.

To turn the Hood Light on, touch the **LIGHT** pad once. To turn the Hood Light off, touch the **LIGHT** pad again.

To turn the Hood Fan on, touch the **FAN HI/LO** pad once for high speed. To turn the Hood Fan to low speed, touch pad twice and touch the pad three times to turn the fan off.

TIME COOKING - MICROWAVE

Your oven can be programmed for 99 minutes 99 seconds (99.99). Always enter the seconds after the minutes, even if they are both zeros.

- Suppose you want to cook for 5 minutes at 100%

PROCEDURE	DISPLAY
1 <input type="text" value="5"/> <input type="text" value="0"/> <input type="text" value="0"/> Enter cooking time.	
2 <input type="text" value="START"/> <input type="text" value="INSTANT ON"/> Touch START/INSTANT ON pad.	

KEEP WARM

KEEP WARM can only be programmed with manual cooking or as a separate program.

- Suppose you want to cook a baked potato for 4 minutes at 100% power and you want to keep it warm after cooking for 30 minutes.

PROCEDURE	
1 <input type="text" value="4"/> <input type="text" value="0"/> <input type="text" value="0"/>	Touch the desired cook time for 1 baked potato. (Ex: 4 minutes.)
2 <input type="text" value="KEEP WARM"/>	Touch KEEP WARM pad.
3 <input type="text" value="START"/> <input type="text" value="INSTANT ON"/>	Touch START/INSTANT ON pad.

At the end of cook time, KEEP WARM is displayed warming food until end of 30 minutes.

To use KEEP WARM as a separate program, touch **KEEP WARM** pad within 1 minute after cooking, closing the door or touching the **STOP/CLEAR** pad.

TO SET POWER LEVEL

There are eleven preset power levels.

Using lower power levels increases the cooking time which is recommended for foods such as cheese, milk and long slow cooking of meats. Consult cookbook or recipes for specific recommendations.

TOUCH POWER LEVEL PAD ONCE THEN TOUCH	APPROXIMATE PERCENTAGE OF POWER	COMMON WORDS FOR POWER LEVELS
POWER LEVEL	100%	High
9	90%	
8	80%	
7	70%	Medium High
6	60%	
5	50%	Medium
4	40%	
3	30%	Med Low/Defrost
2	20%	
1	10%	Low
0	0%	

- Suppose you want to defrost for 5 minutes at 30% with the turntable on.











PROCEDURE	DISPLAY
1 <input type="text" value="5"/> <input type="text" value="0"/> <input type="text" value="0"/> Enter defrosting time.	
2 <input type="text" value="POWER LEVEL"/> <input type="text" value="3"/> Touch POWER LEVEL pad. Enter power level.	
3 <input type="text" value="START"/> <input type="text" value="INSTANT ON"/> Touch START/INSTANT ON pad.	

MICROWAVE FEATURES

AUTO DEFROST

Auto Defrost automatically defrosts ground meat, steaks, chicken pieces.

- Suppose you want to defrost a 2.0 pound steak.

PROCEDURE	DISPLAY
<p>1    </p> <p>Touch AUTO DEFROST pad once. Then touch AUTO DEFROST pad two more times to select steak.</p>	 
<p>2  </p> <p>Enter weight by touching the number pads. (Ex. 2.0 lb)</p>	
<p>3 </p> <p>Touch START/INSTANT ON pad.</p> <p>The oven will stop and directions will be displayed. Follow the indicated message.</p>	

- 4** After the 1st stage, open the door. Turn steak over and shield any warm portions. Close the door.

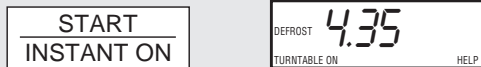

Touch **START/INSTANT ON** pad.

- After the 2nd stage, open the door. Shield any warm portions. Close the door.



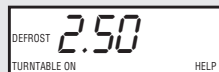



- 5** 



Touch **START/INSTANT ON** pad.

- 6** After defrost cycle ends, cover and let stand as indicated in chart below.

NOTE:

1. The weight can be entered in increments of 0.1 lb. If you attempt to enter more or less than the allowed amount     or   will appear in the display.
2. Auto Defrost can be programmed with More/Less Time Adjustment. See page 25.
3. To defrost other foods or foods above or below the weights allowed on Auto Defrost Chart, use time and 30% power. See Manual Defrost on page 15.

AUTO DEFROST CHART

TOUCH AUTO DEFROST PAD*	FOOD	FOR AMOUNT	PROCEDURE
once	Ground Meat	0.5 - 3.0 lb (0.2 - 1.4 kg)	Remove any thawed pieces after each stage. Let stand, covered, for 5 to 10 minutes.
twice	Steaks (chops, fish)	0.5 - 4.0 lb (0.2 - 1.8 kg)	After each stage of defrost cycle, rearrange and if there are warm or thawed portions, shield with small flat pieces of aluminum foil. Remove any meat or fish that is nearly defrosted. Let stand, covered, for 10 to 20 minutes.
3 times	Chicken Pieces	0.5 - 3.0 lb (0.2 - 1.4 kg)	After each stage of defrost cycle, if there are warm or thawed portions, rearrange or remove. Let stand, covered, for 10 to 20 minutes.

* Number of touches AFTER initial touch to access **AUTO DEFROST**.

- NOTE:** Check foods when oven signals. After final stage, small sections may still be icy. Let stand to continue thawing. Do not defrost until all ice crystals are thawed. Shielding prevents cooking from occurring before the center of the food is defrosted. Use small smooth strips of aluminum foil to cover edges and thinner sections of the food.

MANUAL DEFROST

If the food that you wish to defrost is not listed on the Auto Defrost Chart or is above or below the limits in the "Amount" column on the chart, you need to defrost manually.

You can defrost any frozen food, either raw or previously cooked, by using power level 3. Follow the exact 3-step procedure found under To Set Power Level on page 13. Estimate defrosting time and press 3 for 30% when you select the power level.

For either raw or previously cooked frozen food, the rule of thumb is approximately 5 minutes per pound. For example, defrost 5 minutes for 2-3 cups of casserole or 1 pound of frozen spaghetti sauce.

Always stop the oven periodically to remove or separate the portions that are defrosted. If food is not defrosted at the end of the estimated defrosting time, program the oven in 1 minute increments on power level 3 until totally defrosted.

When using plastic containers from the freezer, defrost only long enough to remove from the plastic in order to place food in a microwave-safe dish.

SENSOR COOKING

Dacor's Sensor is a semi-conductor device that detects the vapor (moisture and humidity) emitted from the food as it heats. The Sensor adjusts the cooking times and power level for various foods and quantities. It takes the guesswork out of microwave cooking.

Using Sensor Settings:

1. Room temperature should not exceed 95°F.
2. Be sure the exterior of the cooking container and the interior of the oven are dry. Wipe off any moisture with a dry cloth or paper towel.
3. Sensor cooking can only be entered within 1 minute after cooking, opening and closing the door or touching the **STOP/CLEAR** pad.

4. During the first part of sensor cooking, **SENSOR** will appear on display. Do not open oven door or touch **STOP/CLEAR** during this part of the cooking

REHEAT	POPCORN	REGULAR	SENSOR	BAKED
POTATO	FROZEN	VEG	SOFT	FRESH
VEG	HARD	FRESH	VEG	FROZEN
ENTREE	HOT	DOGS	BACON	or FISH

cycle. The measurement of vapor will be interrupted. If this occurs, **ERROR** will appear and sensor cooking will be interrupted. To continue cooking, touch the **STOP/CLEAR** pad and select cooking time and power. When sensor detects the vapor emitted from the food, remainder of cooking time will appear. Door may be opened when remaining cooking time appears on display. At this time, you may stir or season food, as desired.

5. Check food for doneness after cooking with sensor settings. If additional time is needed, continue to cook with variable power and time.
6. If the sensor does not detect vapor, **ERROR** will appear and the oven will shut off.
7. At the end of any cycle, open oven door or touch **STOP/CLEAR** pad. The time of day will reappear on the display.
8. Any sensor setting can be programmed with More or Less Time Adjustment. See page 25.

Selecting Foods:

1. The sensor works with foods at normal storage temperature. For example, foods for reheating would be at refrigerator temperature and potatoes for baking would be room temperature.
2. More or less food than the quantity listed in the charts should be cooked by time and variable power.

Covering Foods:

Some foods work best when covered. Use the cover recommended in the Sensor Cooking chart for these foods.

1. Casserole lid.
2. Plastic wrap: Use plastic wrap recommended for microwave cooking. Cover dish loosely; allow approximately 1/2 inch to remain uncovered to allow steam to escape. Plastic wrap should not touch food.
3. Paper towel: Use paper towels to absorb excess fat and moisture when cooking bacon and potatoes. Line the turntable when baking potatoes.
4. Wax paper: Cover dish completely; fold excess wrap under dish to secure. If dish is wider than paper, overlap two pieces at least one inch to cover.

MICROWAVE FEATURES

INSTANT SENSORS

Your oven has Instant Sensor Popcorn and Instant Sensor Reheat. To use any of the Instant Sensors, simply touch the chosen pad. The oven will start automatically. Any sensor setting can be programmed with More/Less Time Adjustment. See page 25.

INSTANT SENSOR REHEAT

Turntable on:

You can reheat many foods by touching just one pad. You don't need to calculate reheating time or power level. To reheat food with turntable on, simply touch the **SENSOR REHEAT** pad.

PROCEDURE

SENSOR REHEAT

Touch **SENSOR REHEAT** pad. (Note : Sensor Reheat can be programmed with turntable on or off).

SENSOR **REHEAT** will be displayed repeatedly. When sensor detects the vapor emitted from the food, remainder of cooking time will appear. After cooking, **LET** **STAND** **COVER** will be displayed.

Turntable off:

You may reheat using a 11"x8"x2" or 13"x9"x2" casserole with the turntable off. First touch **TURN-TABLE ON/OFF** and note indicator. Then touch **SENSOR REHEAT**. The display will indicate turntable off and oven will start automatically. After cooking, **LET** **STAND** **COVER** will be displayed.

INSTANT SENSOR POPCORN

- Suppose you want to pop a 3.5 oz bag of popcorn.

PROCEDURE

POPCORN

Touch **POPCORN** pad once. (Ex: Touch **POPCORN** once for regular size bag.)

SENSOR **POPCORN** **REGULAR** will be displayed repeatedly. After cooking, **END** will be displayed.

This sensor setting works well with most brands of microwave popcorn. You may wish to try several and choose your favorite. Pop only one bag at a time. Unfold the bag and place in oven according to directions.

POPCORN CHART

TOUCH POPCORN PAD FOR AMOUNT

once	3.0 and 3.5 oz bag (Regular size)
twice	1.5 and 1.75 oz bag (Snack size)

INSTANT SENSOR CHART

FOOD	AMOUNT	PROCEDURE
Leftovers such as rice, potatoes, vegetables casserole	4 - 32 oz	Place in dish or casserole slightly larger than amount to be reheated. Flatten, if possible. Cover with lid, plastic wrap or wax paper. Use covers such as plastic wrap or lids with larger quantities of more dense foods such as stews.
Soups	1 - 4 cups	After reheating, stir well, if possible. Foods should be very hot. If not, continue to heat with variable power and time. After stirring, recover and allow to stand 2 to 3 minutes.
Canned entrees and vegetables	4 - 16 oz	Use less Time Adjustment by touching POWER LEVEL pad twice for small quantities of canned vegetables.
Dinner Plate 1 plate	3-6 oz of meat plus vegetables and/or potato/rice	Use this pad to reheat precooked foods from the refrigerator. Place meaty portions and bulky vegetables to outside of plate. Cut large items like baked potatoes in smaller pieces. Flatten foods such as mashed potatoes and other dense foods. Cover with wax paper or plastic wrap. ONE PLATE ONLY . After cooking, check that food is very hot throughout and that the bottom center of the plate is very hot. If not, continue heating using time and power level. Allow to stand, covered, 2 to 3 minutes.
Popcorn	Only 1 package at a time	Use only popcorn packaged for microwave oven use. Try several brands to decide which you like best. Do not try to pop unpopped kernels. More/Less Time Adjustment can be used to provide adjustment needed for older popcorn or individual tastes.

MICROWAVE FEATURES

SENSOR COOK

- Suppose you want to cook a baked potato.

PROCEDURE	DISPLAY
1 SENSOR COOK Touch SENSOR COOK pad.	SELECT FOOD NUMBER
2 1 Select desired sensor setting. Touch 1 to cook baked potatoes.	BAKED POTATO PRESS START

3 Touch **START/INSTANT ON** pad. When sensor detects the vapor emitted from the food, the remainder of cooking time will appear.

LET **STAND**
COVER

Open oven door or touch **STOP/CLEAR** pad. The time of day will appear in the display.

SENSOR COOK CHART

FOOD	AMOUNT	PROCEDURE
1. BAKED POTATOES	1 - 6 medium	Pierce. Place on paper-towel-lined turntable. After cooking, remove from oven, wrap in aluminum foil and let stand 5 to 10 minutes.
2. FROZEN VEGETABLES	1 - 6 cups	Cover with lid or plastic wrap. After cooking, stir and let stand 3 minutes, covered.
3. FRESH VEGETABLES SOFT		Wash and place in casserole. Add no water if vegetables have just been washed. Cover with lid for tender vegetables. Use plastic wrap for tender-crisp vegetables. Stir before standing, if possible. After cooking, let stand, covered, 2 to 5 minutes.
Broccoli	0.25 - 2.0 lb	
Brussels sprouts	0.25 - 2.0 lb	
Cabbage	0.25 - 2.0 lb	
Cauliflower (flowerets)	0.25 - 2.0 lb	
Cauliflower (whole)	1 medium	
Spinach	0.25 - 1.0 lb	
Zucchini	0.25 - 2.0 lb	
Baked apples	2 - 4 medium	
4. FRESH VEGETABLES HARD		Place in casserole. Add 1-4 tbsp water. Cover with lid for tender vegetables. Use plastic wrap cover for tender-crisp vegetables. Stir before standing, if possible. After cooking, let stand, covered, 2 to 5 minutes.
Carrots, sliced	0.25 - 1.5 lb	
Corn on the cob	2 - 4 pcs	
Green beans	0.25 - 1.5 lb	
Winter squash: diced halves	0.25 - 1.5 lb 1 - 2	
5. FROZEN ENTREES	6 - 17 oz	Use for frozen convenience food. It will give satisfactory results for most brands. You may wish to try several and choose your favorite. Remove package from outer wrapping and follow package directions for covering. After cooking, let stand, covered, for 1 to 3 minutes.
6. HOT DOGS	1 - 4 servings	Place hot dog in bun and wrap in paper towel or paper napkin.
7. BACON	2 - 6 slices	Place bacon on paper plate, lined with paper towel. Bacon should not extend over the rim of plate. Cover with paper towel.
8. FISH, SEAFOOD	0.25 - 2.0 lb	Arrange in ring around shallow glass dish (roll fillet with edges underneath). Cover with vented plastic wrap. After cooking, let stand, covered, 3 minutes.

SENSOR COOK RECIPES

Cranberry Fluff

Makes 6 to 8 servings

- | | |
|---|---|
| 2 cups fresh cranberries | 1/2 pint whipping cream, whipped or |
| 1 cup water | 1 carton (8 ounces) non-dairy whipped topping |
| 3/4 cup sugar | |
| 1 carton (3 ounces) orange flavored gelatin | |

- 1 Combine cranberries, water and sugar in a 2-quart casserole. Cover with wax paper. Microwave using **SENSOR COOK** for Fresh Vegetables-soft. Drain cranberries and save liquid.
- 2 Add enough hot water to saved liquid to make 2 cups. Stir the gelatin into hot liquid until it dissolves. Cover with wax paper. Microwave using **SENSOR REHEAT**.
- 3 Add berries and cool. Refrigerate until thickened. Fold whipped cream into cooled cranberry mixture. Spoon into serving dishes and garnish with extra whipped cream. Refrigerate until ready to serve.

Curry Vegetable Chowder

Makes 4 servings

- | | |
|---|-------------------------------------|
| 6 slices bacon | 3/4 teaspoon salt |
| 1 can (10 3/4 ounces) chicken broth | 1/2 teaspoon curry powder |
| 3 medium potatoes, finely diced (about 2 cup) | 1/8 teaspoon pepper |
| 2 carrots, shredded (about 1 cup) | 1 can (12 ounces) evaporated milk |
| 1 small onion, chopped (about 1/2 cup) | 2 tablespoons chopped fresh parsley |

- 1 Layer 2 paper towels on a microwave-safe plate. Arrange bacon on the towels. Cover with another paper towel. Microwave using **SENSOR COOK** for Bacon. Crumble and save bacon.
- 2 Combine chicken broth, vegetables and seasonings in 4-quart casserole. Cover with vented plastic wrap. Microwave using **SENSOR COOK** for Baked potatoes. Vegetables should be tender.
- 3 Stir in evaporated milk. Re-cover with vented plastic wrap. Microwave using **SENSOR REHEAT** Less. Stir in parsley. Let stand, covered, 5 minutes.
- 4 Top each serving with crumbled bacon.

Glazed Apple Slices

Makes 6 to 8 servings

- | | |
|-----------------------------------|--|
| 1/4 cup brown sugar | 3/4 cup orange juice |
| 3 tablespoons margarine or butter | 1 tablespoon cornstarch |
| 2 tablespoons apricot preserves | 4 baking apples (about 1 1/2 pounds), peeled and sliced into 8 pieces each |
| 1/2 teaspoon ground nutmeg | 3 tablespoons chopped green pistachios |
| 1/4 teaspoon salt | |
| 1/2 cup sugar | |

- 1 Combine brown sugar, margarine and apricot preserves in a small bowl. Microwave at HIGH (100%) until margarine melts and preserves soften, 45 seconds to 1 minute. Stir in nutmeg, salt, sugar, orange juice and cornstarch. Microwave at HIGH (100%) until thickened, 4 to 6 minutes, stirring several times.
- 2 Arrange apple slices in a large microwave serving dish. Spread hot sauce over apples. Cover well with vented plastic wrap. Microwave using **SENSOR COOK** for Fresh vegetables-soft. Allow to cool 5 minutes before serving.
- 3 Sprinkle with pistachios. Serve alone or over vanilla ice cream or sponge cake.

MICROWAVE FEATURES

SENSOR COOK RECIPES (CONTINUED)

Mexican Seasoned Potatoes

Makes 6 to 8 servings

4 medium baking potatoes (8 ounces each)	1/2 teaspoon oregano leaves
1/4 cup olive oil	1/4 teaspoon ground cumin
1 tablespoon instant minced onion	1/2 teaspoon salt
1/2 teaspoon chili powder	

- 1 Cut each potato lengthwise into 4 equal wedges. Place potato wedges into 10-inch square casserole. Toss potatoes with oil to coat well.
- 2 In small bowl, combine remaining ingredients. Sprinkle over potatoes.
- 3 Cover potatoes with wax paper. Microwave using **SENSOR COOK** for Baked potatoes setting. Rearrange potatoes when time appears on display. Let stand, covered, 5 minutes.

Spiced Carrots

Makes 6 to 8 servings

3 cups sliced carrots, 1/4 inch thick	2 teaspoons vinegar
1/2 cup chopped green pepper, 1-inch cubes	1 teaspoon soy sauce
1/4 cup finely chopped onion	1/2 teaspoon salt
3 tablespoons water	1/2 teaspoon prepared mustard
1 can (7 3/4 ounces) semi-condensed tomato soup	1/8 teaspoon pepper
1/2 cup sugar	

- 1 In a 1 1/2-quart casserole, combine carrots, green pepper, onion and water. Cover with lid. Microwave using **SENSOR COOK** for Fresh vegetables-hard. Carrots should be tender-crisp. Drain.
- 2 Stir in remaining ingredients. Cover and microwave using **SENSOR REHEAT**.

Savory Flounder Fillets

Makes 4 servings

3/4 cup of corn flake crumbs	1/2 teaspoon paprika
3 tablespoons chopped parsley	1 pound flounder fillets
2 teaspoons grated lemon peel	1 egg, slightly beaten

- 1 On waxed paper, combine corn flake crumbs, parsley, lemon peel and paprika. Dip fillets in beaten egg, then coat with crumb mixture.
- 2 Place fish in a covered, microwave-safe, baking dish. Microwave using **SENSOR COOK** for Fish, seafood.
- 3 Serve with tartar or cocktail sauce or melted cheese.

Creole Corn

Makes 6 servings

2 teaspoons oil	1 teaspoon brown sugar
1/2 cup chopped celery	1/2 teaspoon onion powder
1/2 cup chopped green pepper	1/4 teaspoon garlic powder
16 ounce can tomatoes	salt and pepper to taste
4 ounce can mushroom stem and pieces, drained	1 package (16 ounces) frozen corn

- 1 In 2-quart casserole, combine oil, celery, green pepper, tomatoes, mushrooms, sugar, onion powder, garlic powder, salt and pepper.
- 2 Microwave using **SENSOR REHEAT**. Set aside.
- 3 In covered, 1-quart casserole, microwave corn using **SENSOR COOK** for Frozen vegetables. Drain.
- 4 Combine corn and vegetable-seasoning mixture. Stir and serve immediately.

MANUAL CONVECTION/AUTOMATIC MIX OPERATION

This section of the Operation Manual gives you specific cooking instructions and procedures. Please consult your Dacor Convection Microwave Cookbook for helpful hints for convection and combination cooking.

The oven should not be used without the turntable in place, and it should never be restricted so that it cannot rotate. You may remove the turntable when preheating the oven and when preparing food to be cooked directly on the turntable.

CONVECTION COOKING

During convection heating, hot air is circulated throughout the oven cavity to brown and crisp foods quickly and evenly. This oven can be programmed for ten different convection cooking temperatures for up to 99 minutes, 99 seconds.

TO COOK WITH CONVECTION

- Suppose you want to cook at 350°F for 20 minutes.

PROCEDURE	DISPLAY
1 CONVECTION Touch CONVECTION pad.	SELECT TEMP
2 Touch number pad for desired temperature. (Ex: Pad 6 for 350°F.)	350F ENTER COOKING TIME
3 Enter cooking time. (Ex: 2 0 0 0 min.)	20.00
4 START INSTANT ON Touch START/INSTANT ON pad.	

TO PREHEAT AND COOK WITH CONVECTION

Your oven can be programmed to combine preheating and convection cooking operations. You can preheat at the same temperature as the convection temperature or change it to a higher or lower temperature.

- Suppose you want to preheat until 350°F and then cook 25 minutes at 375°F convection.

PROCEDURE	DISPLAY
1 PREHEAT Touch PREHEAT pad.	SELECT PREHEAT TEMP

2 Touch number pad for desired temperature. (Ex: Pad 6 for 350°F.)	350F	PRESS
	START	OR
	PRESS	CONVECTION

3 Touch CONVECTION then touch number pad for temp. (Ex: 7 for 375°F)	SELECT	TEMP
	375F	ENTER
	COOKING	TIME

4 Enter number pads for cooking time. (Ex: 2 5 0 0)	25.00
---	-------

5 START INSTANT ON	PREHEAT
------------------------------	---------

Touch **START/INSTANT ON** pad.

When the oven reaches the programmed temperature, it will automatically hold at the preheat temperature for 30 minutes and then the display will change to time of day. Whenever **STOP/CLEAR** pad is touched during this 30 minute period, PRESS CONVEC or PRESS MIX will be displayed and cooking mode and time can be entered.

NOTE:

To preheat and cook with the same temperature, enter same temperature in steps 2 and 3.

TO BROIL

In the BROIL setting, preheating is automatic. Just enter the actual broiling time and wait for preheat to be over before adding food. (Preset 450°F). Oven temperature cannot be changed.

- Suppose you want to broil a ham steak for 15 minutes.

PROCEDURE	DISPLAY
1 BROIL Touch BROIL pad.	450F ENTER COOKING TIME

2 Touch number pads to enter cooking time. (Ex: 1 5 0 0)	PREHEAT
--	---------

3 START INSTANT ON	Touch START/INSTANT ON pad.
------------------------------	------------------------------------

MANUAL CONVECTION / AUTOMATIC MIX OPERATION

TO SLOW COOK

Slow Cook is a preset at 300°F. Slow Cook is programmed for 4 hours. Oven temperature can be changed to temperature below 300°F. Simply touch the **SLOW COOK** pad and touch the desired numbered pad with temperature below 300°F.

PROCEDURE	DISPLAY
1 <input type="button" value="SLOW COOK"/>	<input type="text" value="300F"/> <input type="text" value="4 HOURS"/>
Touch SLOW COOK pad.	<input type="button" value="PRESS"/> <input type="button" value="START"/>
2 <input type="button" value="START INSTANT ON"/>	Touch START/INSTANT ON pad. The oven begins counting and continues to 4 hours.

AUTOMATIC MIX COOKING

This oven has two pre-programmed settings that make it easy to cook with both convection heat and microwave automatically.

	OVEN TEMPERATURE	MICROWAVE POWER
HIGH MIX	325°F	30%
LOW MIX	325°F	10%

With the exception of those foods that cook best by convection heating alone, most foods are well suited to mix cooking using either LOW MIX/BAKE or HIGH MIX/ROAST.

The marriage of these two cooking methods produces juicy meats, moist and tender cakes and fine textured breads, all with just the right amount of browning and crispness.

The temperature can be changed; however, the microwave power cannot.

The oven temperature can be changed from 100°F to 450°F. To change the temperature, first touch **HIGH MIX** or **LOW MIX**, then touch the same pad again. When the display says , touch desired temperature pad. Ex: **HIGH MIX**, **HIGH MIX**, pad and **START/INSTANT ON**. The mix temperature will change automatically.

TO COOK WITH AUTOMATIC MIX

- Suppose you want to bake a cake at low mix for 20 minutes.

PROCEDURE	DISPLAY
1 <input type="button" value="LOW MIX BAKE"/>	<input type="text" value="325F"/> <input type="button" value="ENTER"/>
Touch LOW MIX/BAKE pad.	<input type="text" value="COOKING"/> <input type="text" value="TIME"/>
2 <input type="text" value="2"/> <input type="text" value="0"/> <input type="text" value="0"/> <input type="text" value="0"/>	<input type="text" value="20.00"/>
Touch number pads to select time.	<input type="button" value="PRESS"/> <input type="button" value="START"/>
At the end of the baking time, 1 long tone will sound and <input type="text" value="END"/> will be displayed.	

TO PREHEAT AND COOK WITH AUTOMATIC MIX

Your oven can be programmed to combine preheating and Automatic Mix cooking operations. You can preheat at the same temperature as the preset combination temperature or change it to a different temperature.

- Suppose you want to preheat until 350°F and then cook 25 minutes on 325°F Low Mix bake.

PROCEDURE	DISPLAY
1 <input type="button" value="PREHEAT"/>	<input type="button" value="SELECT"/> <input type="button" value="PREHEAT"/>
Touch PREHEAT pad.	<input type="text" value="TEMP"/>
2 Touch number pad for desired temperature (Ex: Pad <input type="text" value="6"/> for 350°F.)	<input type="text" value="350F"/> <input type="button" value="PRESS"/>
	<input type="text" value="START"/> <input type="text" value="OR"/>
	<input type="button" value="PRESS"/> <input type="text" value="CONVECTION"/>
3 <input type="button" value="LOW MIX BAKE"/>	<input type="text" value="325F"/> <input type="button" value="ENTER"/>
Touch LOW MIX/BAKE pad.	<input type="text" value="COOKING"/> <input type="text" value="TIME"/>
4 <input type="text" value="2"/> <input type="text" value="5"/> <input type="text" value="0"/> <input type="text" value="0"/>	<input type="text" value="25.00"/>
Touch number pads to select time.	<input type="button" value="PRESS"/> <input type="button" value="START"/>
5 <input type="button" value="START INSTANT ON"/>	<input type="text" value="PREHEAT"/>
Touch START/INSTANT ON pad.	
At the end of the baking time, 1 long tone will sound and <input type="text" value="END"/> will be displayed.	

CONVECTION AUTOMATIC MIX FEATURES

This section of the operation manual offers instructions for preparing 12 popular foods using Auto Broil, Auto Roast and Auto Bake.

























After selecting the desired feature, follow the directions indicated in the display.

For helpful hints, simply touch **HELP GUIDE** anytime **HELP** is lighted in the display.

AUTO BROIL

Auto Broil automatically broils hamburgers, chicken pieces, steaks and fish steaks.

- Suppose you want to broil 2 hamburgers.

PROCEDURE	DISPLAY
1  Touch AUTO BROIL pad.	  
2  Touch number pad. (Ex: for hamburgers, touch  .)	        
3  Touch number pad to enter quantity. (Ex:  .) Follow information in display for cooking information.	      

For well done or rare burgers, touch **POWER LEVEL** pad to select More for well done or Less for rare. See More/ Less Time Adjustment on page 25.





AUTO BROIL CHART

SETTING/FOOD	AMOUNT	PROCEDURE
1. HAMBURGERS	1 - 8 pieces 1/4 lb each	Use this setting to broil hamburger patties. Place on low rack.
2. CHICKEN PIECES	0.5 - 3.0 lb	Arrange pieces on low rack. After cooking, let stand, 3-5 minutes. Dark meat should be 180°F, and white meat should be 170°F.
3. STEAKS	0.5 - 2.0 lb	Use this setting to broil steaks from 3/4" to 1" thick. Individual boneless steaks broil evenly. Place steak on low rack. For well done, touch POWER LEVEL once; for rare, touch POWER LEVEL twice.
4. FISH STEAKS	0.5 - 2.0 lb	Use this setting to broil fish steak which is 3/4" to 1" thick. Place on low rack.

4 



Touch **START/INSTANT ON** pad.





















After broil preheat cycle ends, 4 long tones will sound.    
 will be displayed repeatedly. Open the door and place hamburgers into oven. Close the door.

5 

Touch **START/INSTANT ON** pad.

After broil cycle ends, 1 long tone will sound and  will be displayed.

NOTE:

1. Auto Broil can be programmed with More/Less Time Adjustment. See page 25.
2. If you attempt to enter more or less than the allowed weight     
 or    
  will appear in the display. If you enter more or less than the allowed number     or 
    will appear in the display.
3. To broil other foods or foods above or below the weight or number allowed on the chart below, follow instructions in the Dacor Convection Microwave Cookbook. See Broiling Chart.

CONVECTION AUTOMATIC MIX FEATURES

AUTO ROAST

Auto Roast automatically roasts chicken, turkey, turkey breast or pork.

- Suppose you want to roast a 2.5 pound chicken.

PROCEDURE	DISPLAY
1 AUTO ROAST Touch AUTO ROAST pad.	SELECT FOOD NUMBER
2 1 Touch number pad. (Ex: for chicken touch 1 .)	CHICKEN USE LOW RACK ENTER WEIGHT
3 2 5 Touch number pad to enter weight. (Ex: 2.5)	2.5 PRESS START

4

START
INSTANT ON

Touch **START/INSTANT ON** pad.

After AUTO ROAST cycle end, a long tone will sound. LET STAND COVERED FOR 5-10 MIN will be displayed.

NOTE:

1. Auto Roast can be programmed with More/Less Time Adjustment. See page 25.
2. If you attempt to enter more or less than the allowed weight, ERROR WEIGHT TOO LARGE PRESS CLEAR or ERROR WEIGHT TOO SMALL PRESS CLEAR will appear in the display.
3. To roast other food or foods above or below the weights allowed on the chart below, check the Dacor Convection Microwave Cookbook's Combination Roasting Chart.

AUTO ROAST CHART

SETTING FOOD	AMOUNT	RACK	PROCEDURE
1. CHICKEN	2.5 - 7.0 lb (1.2 - 3.1 kg)	Low	After the cycle ends, cover with foil and let stand for 5-10 minutes. Internal temperature of white meat should be 170°F and of dark meat, 180°F.
2. TURKEY (UNSTUFFED)	6.5 - 9.0 lb (3.0 - 4.0 kg)	Low	Season, as desired. Place on low rack. After the cycle ends, cover with foil and let stand 10 minutes. Internal temperature of white meat should be 170°F and of dark meat, 180°F.
3. TURKEY BREAST	3.0 - 6.0 lb (1.4 - 2.7 kg)	Low	Season, as desired. Place on low rack. After the cycle ends, cover foil and let stand 10 minutes. Internal temperature of white meat should be 170°F.
4. PORK	2.0 - 3.5 lb (0.9 - 1.5 kg)	Low	Boneless pork loin is recommended because it cooks evenly. Place on low rack. After cooking, remove from oven, cover with foil and allow to stand 5-10 minutes. Internal temperature should be 160°F.

CONVECTION AUTOMATIC MIX FEATURES

AUTO BAKE

Auto Bake automatically bakes cakes, brownies, muffins and French fries.

- Suppose you want to bake a 13"x9"x2" cake.

PROCEDURE	DISPLAY
1 AUTO BAKE Touch AUTO BAKE pad. Note: Turntable function is automatically turned OFF.	SELECT FOOD NUMBER
2 1 Touch number pad. (Ex: for cake, touch 1 .)	CAKE USE 13X9X2 INCH METAL PAN ON LOW RACK NO FOOD IN OVEN PRESS START

3

START
INSTANT ON



Touch **START/INSTANT ON** pad.

After Auto Bake preheat cycle ends, 4 tones will sound. The display will indicate PREHEAT OVER PLACE FOOD IN OVEN. Open door. Place the cake pan inside. Close door and touch **START/INSTANT ON**.

4

START
INSTANT ON

Touch **START/INSTANT ON** pad.

After AUTO BAKE cycle ends, 1 long tone will sound, and END will be displayed.

NOTE:

1. Auto Bake can be programmed with More/Less Time Adjustment. See page 25.
2. To bake other food, see the Dacor Convection Microwave Cookbook's Baking Section.

AUTO BAKE CHART

SETTING	FOOD	PAN SIZE/QTY	RACK	PROCEDURE
1. CAKE		13"x9"x2"	Low	Ideal for packaged cake mix or your own recipe for 13"x9"x2" pan. Prepare according to package or recipe directions and place in a greased and floured 13"x9"x2" baking pan. After the preheat is over, place pan in oven centered on low rack. Cool before frosting and serving.
2. BROWNIES		13"x9"x2"	Low	Ideal for packaged brownie mix or your own recipe for 13"x9"x2" pan. Prepare according to package or recipe directions and place in a greased and floured 13"x9"x2" baking pan. After the preheat is over, place pan in oven centered on low rack. Cool before cutting into serving pieces.
3. MUFFINS		12 cup Muffin pan	Low	Ideal for packaged muffin mix or your own recipe for 12 medium size muffins. Prepare according to package or recipe directions and place in one 12-cup muffin pan. After the preheat is over, place pan in oven centered on low rack.
4. FRENCH FRIES		3 to 24 oz Cookie sheet to hold	Low	Use frozen prepared French fries. No preheat is required for the French fries baking procedure. Place French fries on cookie sheet on low rack. For shoestring potatoes, touch POWER LEVEL pad twice to enter less time before touching START/INSTANT ON pad.

OTHER CONVENIENT FEATURES

MULTIPLE SEQUENCE COOKING

The oven can be programmed for up to 4 automatic cooking sequences for the microwave mode and 3 automatic cooking sequences for convection mode, switching from one setting to another automatically.

Sometimes cooking directions tell you to start on one power level and then change to a different power level. Your oven can do this automatically.

- Suppose you want to cook roast beef for 5 minutes at 90% and then continue to cook for 30 minutes at 50%.

PROCEDURE		
1	POWER LEVEL	Touch POWER LEVEL pad once.
2	9	Touch POWER LEVEL number. (Ex: 90%)
3	5 0 0	Enter cooking time. (Ex: 5 minutes.)
4	POWER LEVEL	Touch POWER LEVEL pad again.
5	5	Touch POWER LEVEL number. (Ex: 50%)
6	3 0 0 0	Enter cooking time. (Ex: 30 minutes.)
7	START INSTANT ON	Touch START/INSTANT ON pad.

NOTE:

1. If **POWER LEVEL** pad is touched twice, **HIGH** will be displayed.
2. If 100% is selected as the final sequence, it is not necessary to touch the **POWER LEVEL** pad.
3. If you wish to know power level, simply touch the **POWER LEVEL** pad. As long as your finger is touching the **POWER LEVEL** pad, the power level will be displayed.

MORE OR LESS TIME ADJUSTMENT

More : Should you discover that you like any of the AUTO DEFROST, AUTO ROAST, AUTO BAKE, AUTO BROIL, SENSOR COOK or INSTANT SENSOR settings slightly **more** done, touch the **POWER LEVEL** pad **once** after touching your choice of pads.

Less : Should you discover that you like any of the AUTO DEFROST, AUTO ROAST, AUTO BAKE, AUTO BROIL, SENSOR COOK or INSTANT SENSOR settings slightly **less** done, touch the **POWER LEVEL** pad **twice** after touching your choice of pads.

KITCHEN TIMER

- Suppose you want to time a 3 minute long distance phone call.

PROCEDURE		
1	KITCHEN TIMER	Touch KITCHEN TIMER pad.
2	3 0 0	Enter time.
3	START INSTANT ON	Touch START/INSTANT ON pad.

EASY MINUTE

Easy Minute allows you to cook for a minute at 100% by simply touching the **EASY MINUTE** pad. You can also extend cooking time in multiples of 1 minute by repeatedly touching the **EASY MINUTE** pad during manual cooking using microwave, convection, mix or broil.

- Suppose you want to heat a cup of soup for one minute.

PROCEDURE	
EASY MINUTE	Touch EASY MINUTE pad.

NOTE:

1. Touch **EASY MINUTE** pad within 1 minute after cooking, closing the door, touching the **STOP/CLEAR** pad or during cooking. Easy Minute cannot be used to start the oven if any program is on display.
2. Easy Minute cannot be used with Special Features.

DEMONSTRATION MODE

To demonstrate, touch **CLOCK**, **0** and **START/INSTANT ON** and hold for three seconds. **DEFRO** **ON** **DURING** **DEFRO** **NO** **OVEN** **POWER** and **DEFRO** will appear in the display. Cooking operations and special features can now be demonstrated with no power in the oven. For example, touch **EASY MINUTE**, and the display will show **1.00** and count down quickly to **0** and the **END**.

To cancel, touch **CLOCK**, the number **0** and **STOP/CLEAR**.

HELP

Each setting of Auto Defrost, Auto Broil, Auto Roast, Auto Bake and Sensor Cook has a cooking hint. If you wish to check, touch **HELP GUIDE** whenever HELP is lighted in the Interactive Display.

OTHER CONVENIENT FEATURES

HELP GUIDE

Help Guide provides 5 features which make using your oven easy because specific instructions are provided in the Interactive Display.

1. CHILD LOCK

The Child Lock prevents unwanted oven operation such as by small children. Note: Child Lock is not applicable to Hood Fan and Hood Light buttons.

The oven can be set so that the control panel is deactivated or locked. To set, touch **HELP GUIDE**, the number **1** and **START/INSTANT ON** pad. Should a pad be touched, **LOCK** will appear in the display.

To cancel, touch **HELP GUIDE**, the number **1** and **STOP/CLEAR**.

2. AUDIBLE SIGNAL ELIMINATION

If you wish to have the oven operate with no audible signal, touch **HELP GUIDE**, the number **2** and **STOP/CLEAR**.

To cancel and restore the audible signal, touch **HELP GUIDE**, the number **2** and **START/INSTANT ON**.

3. AUTO START

If you wish to program your oven to begin cooking automatically at a designated time of day, follow this procedure:

- Suppose you want to start cooking a stew for 20 minutes on 50% at 4:30. Before setting, check to make sure the clock is set correctly.

PROCEDURE		
1	HELP GUIDE	Touch HELP GUIDE pad.
2	3	Touch the number.
3	4 3 0	Enter the start time.
4	CLOCK	Touch CLOCK pad.
5	2 0 0 0	Enter cooking program.
6	START INSTANT ON	Touch START/INSTANT On pad.

NOTE:

1. Auto Start can be used for manual cooking, Auto Broil/Roast/Bake, if clock is set.
2. If the oven door is opened after programming Auto Start, it is necessary to touch the **START/INSTANT ON** pad for the time of day to appear in the readout so that the oven will automatically begin programmed cooking at the chosen Auto Start time.

3. Be sure to choose foods that can be left in the oven safely until the Auto Start time. Baked potatoes are often a good choice.

4. LANGUAGE SELECTION

The oven comes set for English language. To change, touch **HELP GUIDE** and the number **4**. Continue to touch the number **4** until your choice is selected from the table below. Then touch **START/INSTANT ON** pad.

NUMBER 4	LANGUAGE	DISPLAY
Once	English	ENGLISH
Twice	Spanish	ESPAÑOL
3 times	French	FR

5. WEIGHT/TEMP SELECTION

The oven comes set for U.S. Customary Unit-pounds. To change, touch **HELP GUIDE** and the number **5**. Continue to touch the number **5** until your choice is selected from the table below. Then, touch **START/INSTANT ON** pad.

NUMBER 5	STANDARD OF WEIGHT AND TEMPERATURE	DISPLAY
Once	Pound/Fahrenheit	LB F
Twice	Kilogram/Celsius	KG C

INSTANT ON

Instant On allows you to cook at 100% power by touching the **START/INSTANT ON** continuously. Instant On is ideal for melting cheese, bringing milk to just below boiling etc. The maximum cooking time is 3 minutes.

- Suppose you want to melt cheese on a piece of toast.

PROCEDURE	
1	START INSTANT ON Continuously touch START/INSTANT On pad. The cooking time will begin counting up.
2	When the cheese is melted to desired degree, remove finger from START/INSTANT On pad. Oven stops immediately.

NOTE:

1. Note time it takes for frequently used foods and program that time in the future.
2. Touch **INSTANT On** pad within 1 minute after cooking, opening and closing the door or touching the **STOP/CLEAR** pad.
3. **INSTANT ON** can only be used 3 times in a row. If more times are needed, open and close door or touch **STOP/CLEAR**.

CLEANING AND CARE

EXTERIOR

The outside surface is precoated metal and plastic. Clean the outside with mild soap and water; rinse and dry with a soft cloth. Do not use any type of household or abrasive cleaner.

DOOR

Wipe the window on both sides with a damp cloth to remove any spills or splatters. Metal parts will be easier to maintain if wiped frequently with a damp cloth. Avoid the use of harsh abrasives.

TOUCH CONTROL PANEL

Care should be taken in cleaning the touch control panel. If the control panel becomes soiled, open the oven door to inactivate the control panel before cleaning. Wipe the panel with a cloth dampened slightly with water only. Dry with a soft cloth. Do not scrub or use any sort of chemical cleaners. Avoid the use of excess water. Close door and touch **STOP/CLEAR**.

INTERIOR-AFTER MICROWAVE COOKING

The oven walls, ceiling and floor are stainless steel. Cleaning after microwave cooking is easy because no heat is generated to the interior surfaces; therefore, there is no baking and setting of spills or spattering. To clean the interior surfaces, wipe with a soft cloth and warm water. **DO NOT USE ABRASIVE OR HARSH CLEANERS OR SCOURING PADS.** For heavier soil, use mild soap; rinse thoroughly with hot water.

INTERIOR-AFTER CONVECTION, MIX OR BROIL COOKING

Spatters may occur because of moisture and grease. Wash immediately after use with hot, soapy water. Rinse and polish dry. Harder to remove spatters may occur if oven is not thoroughly cleaned or if there is long time/high temperature cooking. If so, you may wish to purchase an oven cleaner pad with liquid cleaner within it-not a soap filled steel pad-for use on stainless or porcelain surfaces. Follow manufacturer's directions carefully and be especially cautious not to get any of the liquid cleaner in the perforations on the wall or ceiling or any door surfaces. Rinse thoroughly and polish dry.

WAVEGUIDE COVER

The waveguide cover is located on the ceiling in the oven cavity. It is made from mica so requires special care. Keep the waveguide cover clean to assure good oven performance. Carefully wipe with a damp cloth any food spatters from the surface of the cover immediately after they occur. Built-up splashes may over-heat and cause smoke or possibly catch fire. **DO NOT REMOVE THE WAVEGUIDE COVER.**

ODOR REMOVAL

Occasionally, a cooking odor may remain in the oven. To remove, combine 1 cup water, grated peel and juice of 1 lemon and several whole cloves in a 2-cup glass

measuring cup. Boil for several minutes using 100% power. Allow to set in oven until cool. Wipe interior with a soft cloth.

TURNTABLE/TURNTABLE SUPPORT

The ceramic turntable and turntable support can be removed for easy cleaning. Wash them in mild, sudsy water; for stubborn stains use a mild cleanser and scouring sponge as described above. They are also dishwasher-safe using top rack.



OVEN RACKS

The high and low baking racks can be removed for easy cleaning and stored away from the microwave oven when racks are not needed. After each use, wash them in mild, sudsy water. For any stubborn stains, use a mild kitchen cleanser and scouring sponge as described above. They are dishwasher-proof.

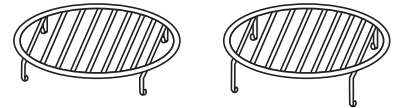

GREASE FILTERS

Filters should be cleaned at least once a month. Never operate the fan or oven without the filters in place.

1. Pull the tab toward the front of the oven, down slightly and remove the filter. Repeat for the other filter.
2. Soak the filters in a sink or dish pan filled with hot water and detergent. **DO NOT** use ammonia or other alkali; they will react with the filter material and darken it.
3. Agitate and scrub with a brush to remove embedded dirt.
4. Rinse thoroughly and shake dry.
5. Replace by fitting the filter back into the opening.

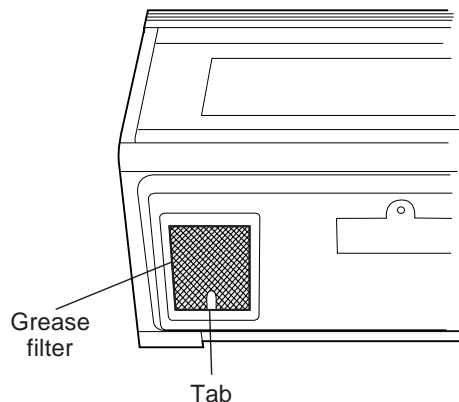

CLEANING AND CARE

FAN

The fan will automatically start when heat rises from range surface units or burners and when convection, high mix, low mix or the broil settings are used. This protects the microwave oven from excessive temperature rise. The fan will stay on until the temperature decreases. It cannot be turned off manually during this time.

For other uses, select either high or low speed.

PRECAUTIONS FOR PROPER USE:

1. DO NOT leave range unattended while using high temperatures. Automatic fan may start and provide excessive air to the surface units. This may cause spattering or boilover.
2. Avoid burning food.
3. Keep grease filters clean.

LIGHT

1. To replace light bulbs, first disconnect power to the oven at the circuit breaker panel or by unplugging.
2. To release cover remove the screw on the light cover. (See illustration.)
3. Replace bulbs only with 20 watt bulbs (part #RLMPTA068WRE0) available from a Dacor Authorized Servicer or parts distributor. Bulbs are also available at most hardware stores or lighting centers. DO NOT USE A BULB LARGER THAN 30 WATTS.
4. Close light cover and secure with screw removed in step 2.

CAUTION: Light cover may become very hot. Do not touch glass when light is on. Do not use light for long time use such as a night light.

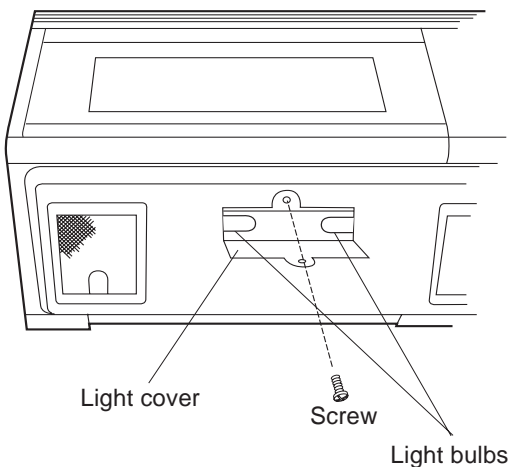

CHARCOAL FILTER

Charcoal Filter is used for No-vented, recirculated installation. The filter should be changed every 6 to 12 months depending on use.

1. Disconnect power to the oven at the circuit breaker panel or by unplugging.
2. Remove 3 screws that secure louver.
3. Pull the louver away from the oven.
4. Slide Charcoal Filter into position on support tabs.
5. Push louver back into place and gently snap tabs into place by hand and replace the 2 screws to secure louver.

OVEN LIGHT

Remove the louver per instructions 1-3 above and charcoal filter, if used.

4. Slide the light cover forward and lift up.
5. Remove old light bulb and replace only with 20 watt bulb (part #RLMPTA068WRE0) available from a Dacor Authorized Servicer or parts distributor. Bulbs are also available at most hardware stores or lighting centers. DO NOT USE A BULB LARGER THAN 30 WATTS.
6. Replace the oven light cover and charcoal filter, if used; push louver back in place and replace the louver mounting screws.

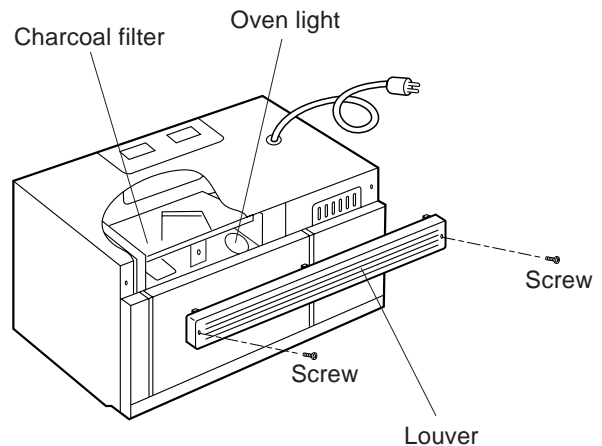

SERVICE CALL CHECK

Please check the following before calling for service:

- Place one cup of water in a glass measuring cup in the oven and close the door securely.
Operate the oven for two minutes at HIGH 100%.

- | | |
|---|--------------------|
| A. Does the light come on in the oven? | YES _____ NO _____ |
| B. Does the cooling fan work?
(Put your hand over the top ventilation openings.) | YES _____ NO _____ |
| C. Does the turntable rotate when the TURNTABLE ON/OFF pad is touched and TURNTABLE ON is in the display?
(It is normal for the turntable to turn in either direction when TURNTABLE ON is in the display.) | YES _____ NO _____ |
| D. Is the water in the oven warm? | YES _____ NO _____ |

- Remove the water from the oven and program: CONVECTION 450°F 5 0 0 START
INSTANT ON

- | | |
|---|--------------------|
| A. Do CONV and COOK light? | YES _____ NO _____ |
| B. After the oven shuts off, is the inside of the oven hot? | YES _____ NO _____ |

If "NO" is the answer to any of the above questions, please check electrical outlet, fuse and/or circuit breaker. If either or both are not functioning properly, CONTACT YOUR NEAREST DACOR AUTHORIZED SERVICER. A microwave oven should never be serviced by a "do-it-yourself" repair person.

NOTE: If time appearing in the display is counting down very rapidly, check Demonstration Mode on page 25 and cancel.

SPECIFICATIONS

PCOR30B / PCOR30R / PCOR30S

AC Line Voltage:	UL Rating	- Single phase 120V, 60Hz, AC only
	CSA Rating	- Single phase 116V, 60Hz, AC only
AC Power Required:	UL Rating	- 1600 W 13.2 amps.
	CSA Rating	- 1500 W 13.0 amps.
Output Power Microwave:	850 W* (IEC Test Procedure)	
Convection Heater:	1400 W	
Frequency:	2450 MHz	
Outside Dimensions:	29 15/16" (W) x 16 11/32" (H) x 15 9/32" (D)	
Cavity Dimensions:	17 1/8" (W) x 8 1/16" (H) x 13 13/16" (D)	
Oven Capacity:	1.1 cu. ft.	
Cooking Uniformity:	Turntable & Stirrer Fan	
Weight:	Approx. 71 lbs	

★ The International Electrotechnical Commission's standardized method for measuring output wattage. This test method is widely recognized.

In compliance with standards set by:

FCC – Federal Communications Commission Authorized.

DHHS – Complies with Department of Health and Human Services (DHHS) rule, CFR, Title 21, Chapter I, Subchapter J.



– This symbol on the nameplate means the product is listed by Underwriters Laboratories, Inc. for use in USA or Canada.

QUICK REFERENCE

For more complete information and safety precautions, refer to the inside instructions.

SET CLOCK

If *WELCOME PRESS CLEAR AND PRESS CLOCK* is in the display, first touch **STOP/CLEAR**.

1. Touch **CLOCK** pad.
2. Enter correct time of day by touching numbers in sequence. (Ex: 12:30)
3. Touch **CLOCK** pad again.

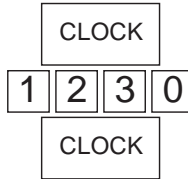

INSTANT SENSOR POPCORN

Touch **POPCORN** pad. Instant Once for regular size and twice for snack size. See page 16.



INSTANT SENSOR REHEAT

Touch **SENSOR REHEAT** once. The oven will start automatically. **SENSOR REHEAT** can be programmed with turntable on or off. See Instant Sensor Chart on page 16.



SENSOR COOK

1. Touch **SENSOR COOK** pad.
 2. Select desired **SENSOR COOK** setting. (Ex: **1**)
 3. Touch **START/INSTANT ON** pad.
- See Sensor Cook Chart, page 17.



1



TO PREHEAT AND COOK WITH CONVECTION

1. Touch **PREHEAT** pad.
2. Touch number pad for desired temperature. (Ex: touch pad **6** for 350°F.)
3. Touch **CONVECTION** pad.
4. Touch number pad for desired temperature. (Ex: **5** for 325°F.)
5. Enter cooking time by touching number pads. (Ex: **2****0****0****0**.)
6. Touch **START/INSTANT ON** pad.



When the oven reaches the programmed temp., it will automatically hold at the preheat temperature for 30 minutes and then the display will change to the time of day. Whenever **STOP/CLEAR** is touched during this 30 minute period, **PRESS CONVEC** or **PRESS MIX** will be displayed and cooking mode and time can be entered.

For more information on convection cooking, see pages 20 and 21.

MANUAL OPERATION

High Power Cooking

1. Enter cooking time by touching numbers pads. (Ex: 1 min. 30 sec.)
2. Touch **START/INSTANT ON** pad.

1 3 0



Variable Power Cooking

2. After Step 1 above, touch **POWER LEVEL** pad.
3. Select power level (Ex: 5 for 50%) and touch **START/INSTANT ON** pad.



EASY MINUTE

Touch **EASY MINUTE** for one minute at 100% power or to add additional minutes.



INSTANT ON

Continuously touch **START/INSTANT ON** for 100% power cooking. Remove finger and oven will stop instantly.



AUTO DEFROST

1. Touch **AUTO DEFROST** pad (Ex: three times for a steak).
2. Enter weight by touching number pad. (Ex: **2** and **0**.)



2 0

3. Touch **START/INSTANT ON** pad.



During defrosting, oven will stop. Check food. See Auto Defrost Chart on page 14.

AUTO ROAST

or Auto Bake or Auto Broil

1. Touch desired **AUTO** pad.
2. Select desired Auto setting. (Ex: Touch **1** for chicken.)
3. Touch number pad for weight or quantity.
4. Touch **START/INSTANT ON** pad.



1

2 5

See Auto Roast, Bake and Broil Charts on pages 22, 23 and 24.



TO COOK WITH AUTOMATIC MIX

Touch **LOW MIX/BAKE** pad, enter desired cooking time and touch **START/INSTANT ON** pad. Follow information on the display.

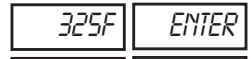

Your oven can be programmed to combine preheating and automatic mix cooking operations. See page 20 for information.

dacor

The life of the kitchen™

DACOR INC.

1440 Bridge Gate Drive, Diamond Bar, CA 91765
1-800-793-0093 • www.dacor.com

