

P3200 SERIES RANGE HOOD

Enhance ventilation and capture the ultimate chef's experience with our latest design, the P3200 series range hood.

Experience...

REMOTE CONTROL

- Easy to operate
- Optional automatic 5 minute shut off timer

EASY CLEANING

- Dishwasher safe commercial baffle filters
- Functional design is easy to clean. Eliminates grease traps
- No unsightly screws to clean around

QUIET OPERATION

- Rubber-mounted motor & large, squirrel-cage blowers reduce sound and vibration
- 3-speed motor control reduces blower and air movement sound
- Large, oversized filters reduce air movement sound

ENDURING QUALITY

- Internal motor models deliver 390 CFM (code compliant), 600 CFM, or 780 CFM
- Commercial grade stainless steel (#304 grade with #4 brush finish)
- Two oversized 15" x 14" stainless steel baffle filters improve performance; three on 48" model
- Two LED lights brighten cooking area; three on 48" model
- Performance tested for CFM

DISTINCTIVE DESIGN

- Style complements ALL kitchen designs
- Simplicity of design preferred by home owners and builders
- Recessed controls and LED lights. Buttons and light glare hidden from the front
- Electronic touch controls with blue LED back lighting, with NEW REMOTE CONTROL
- Trade-Wind® logo is discretely located on bottom of hood. Can be paired with ALL range models

EASY INSTALLATION

- Installs easily in standard size cabinet openings
- Exhausts out the top with a 7", 8", or 10" round discharge opening (size of ducting is dependent on blower CFM specification selected)
- For Installation Instructions, visit us on the web at www.t-wusa.com

P3200 SERIES

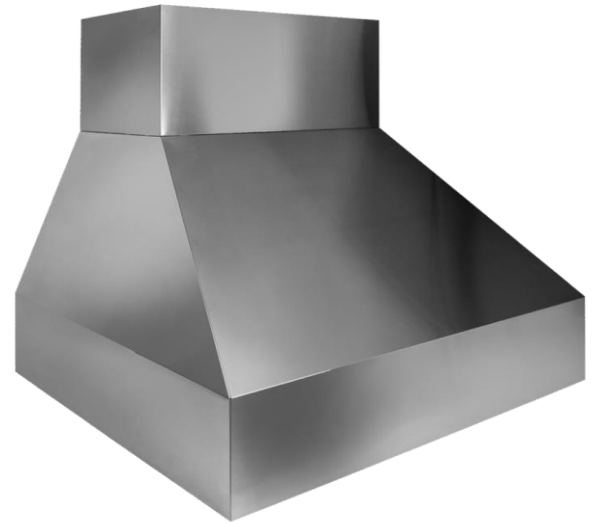

P3200 SERIES RANGE HOOD

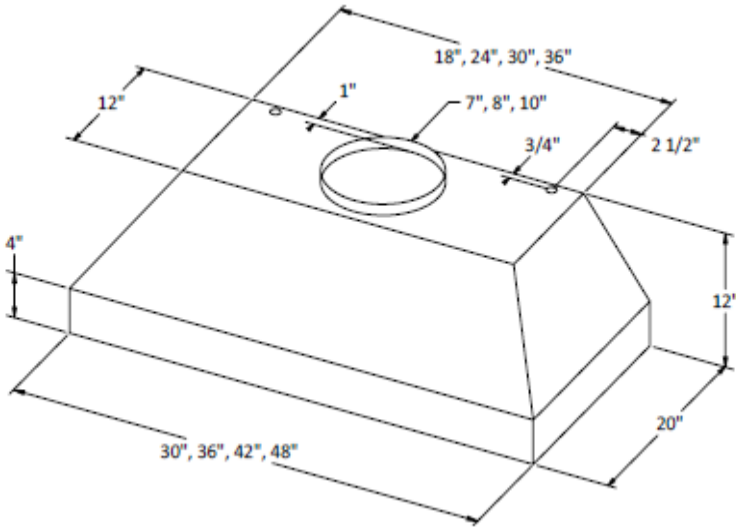

Duct Cover
(included for ceilings from 8' to 10')

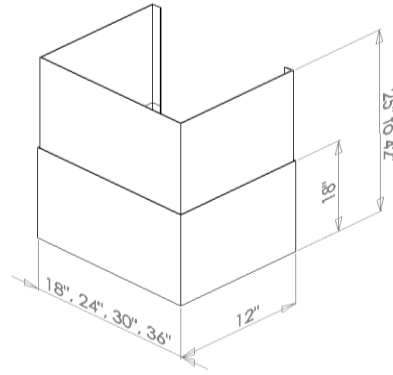

*Please note that measurements provided reflect the bottom of the hood being 30" above the stove.

Duct Cover
(sold separately for ceilings from 10' to 12')

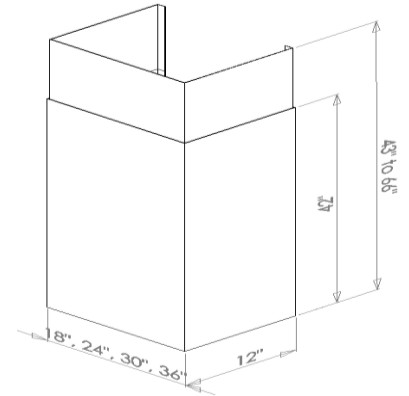

Dimensions			
Models	Width	CFM	Duct Opening
P32303RC	30"	390	7"
P32363RC	36"	390	7"
P32423RC	42"	390	7"

Dimensions			
Models	Width	CFM	Duct Opening
P32306RC	30"	600	8"
P32366RC	36"	600	8"
P32426RC	42"	600	8"
P32487RC	48"	780	10"

Note: Electrical access located on the top, right side as shown in the above dimensioned diagrams.

- All dimensions are nominal +/- 1/8"
- All models exhaust vertically through a 7", 8", or 10" round duct
(For rear discharge use a 90° elbow, not provided)

Trade-Wind Manufacturing, LLC® has a policy of continuous improvements and reserves the right to modify (at any time without notice) any or all of its products, features, designs, components and specifications. For further information on installation and wiring, see the installation instructions included with the product or visit us on the web.

- Optional Duct Covers**
- PDC3230- EXT KIT for P3230
 - PDC3236- EXT KIT for P3236
 - PDC3242- EXT KIT for P3242
 - PDC3248- EXT KIT for P3248

For more information, please contact your dealer or your Trade-Wind® representative.



800 West Grant Street, Phoenix, AZ 85007
1-800-955-5737
602-900-8500
t-wusa.com

