

# MONOGRAM 30" BUILT-IN ADVANTIUM® 120 ZSB9131NSS

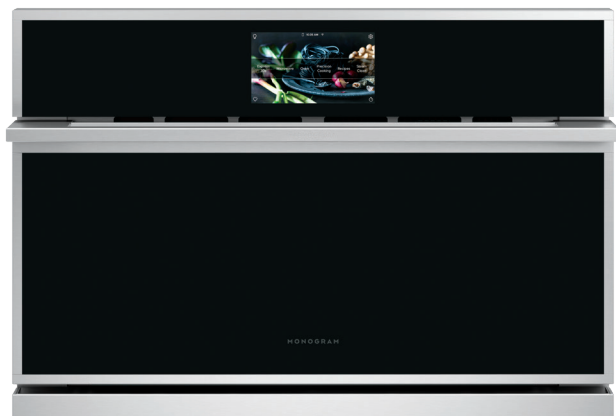

## THE MONOGRAM MINIMALIST COLLECTION

Streamlined design and precisely machined metals create a contemporary yet functional aesthetic

### 5-IN-1-OVEN

Experience exceptional flexibility and cooking results with this innovative five-in-one oven. Advantium® Technology enhanced, it can be used as a convection oven, toaster oven, warming/proofing oven, precision cook oven, and microwave

### POWERFUL PERFORMANCE

Oven-quality foods cook up to four times faster than a conventional oven, with no preheating required

### SPEEDCOOK TECHNOLOGY

Offering the ultimate in cooking speed and flexibility, the halogen-lighting system combines with microwave technology to Speedcook favorite foods to perfection in minutes, with no preheating

### SPACIOUS INTERIOR

Generous, 1.7-cu.-ft oven space with a large 16" turntable allows for full rotation of a 9" x 13" casserole dish; plus the removable oven rack offers the convenience of multi-level cooking

### PREPROGRAMMED RECIPES

Provide quick and easy programming of over 175 pre-set food selections and allows programming of up to 30 custom recipes

### INSTALLATION FLEXIBILITY

Ovens can be installed in 30" wall cabinet and can also be installed undercounter

### LCD CONTROLS

Allow you to adjust oven settings with little effort

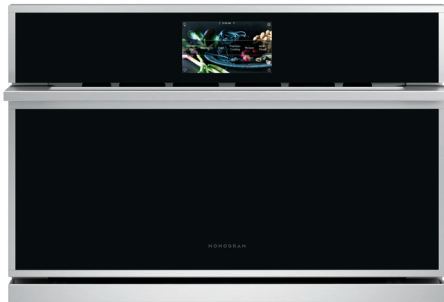

**SPECIFICATIONS**

Overall Width	29 3/4" (75.6 cm)
Overall Height	20 1/4" (51.4 cm)
Overall Depth	23" (58.4 cm)
Oven Door Clearance	13 1/4" (33.65 cm)
Overall Oven Interior Capacity	1.7 cu. ft.
Oven Interior Dimensions (W x H x D)	20 1/16" x 8 1/2" x 17" (51 cm x 21.6 cm x 43.2 cm)
Minimum Cabinet Width	30" (76.2 cm)
Minimum Cabinet Depth	21 1/2" (54.6 cm)
Minimum Base Support	130 lbs (59 kg)
Cutout Width	25 1/4" (64.1 cm)
Cutout Height	17 1/2" (44.5 cm)
Cutout Depth	21 1/2" (54.6 cm) Min
Volt/Hertz/Amps	120 VAC, 60 Hz, 15 Amps
Conduit Length	48 1/2" (123.2 cm)
Electrical Rating	1.8 kW at 120V
Total Amps	15 amps
Shipping Weight	92 lbs (41.7 kg)

**ATTENTION ELECTRICIAN:**

A 120V, 60Hz, 15 Amp circuit is required. An individual properly grounded branch circuit or circuit breaker is required. Hardware junction box is required for built-in product.

**OVERALL DIMENSIONS**

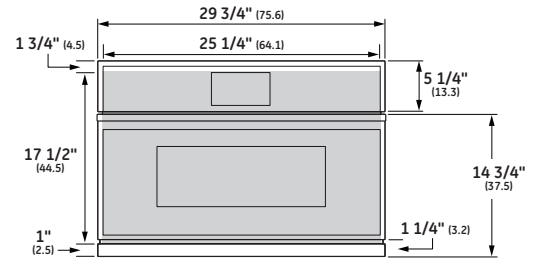

**FRONT VIEW (SHOWING CUTOUT OVERLAP)**

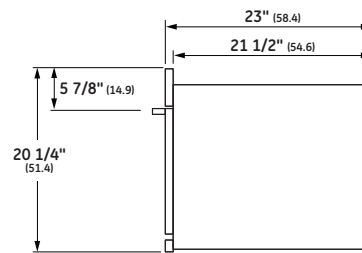

**SIDE VIEW**

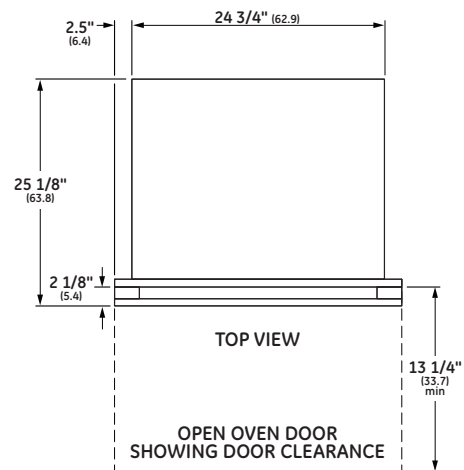

**TOP VIEW**

Dimensions in parentheses are in centimeters unless otherwise noted. Actual product dimensions may vary due to manufacturing tolerances.

## WALL INSTALLATION

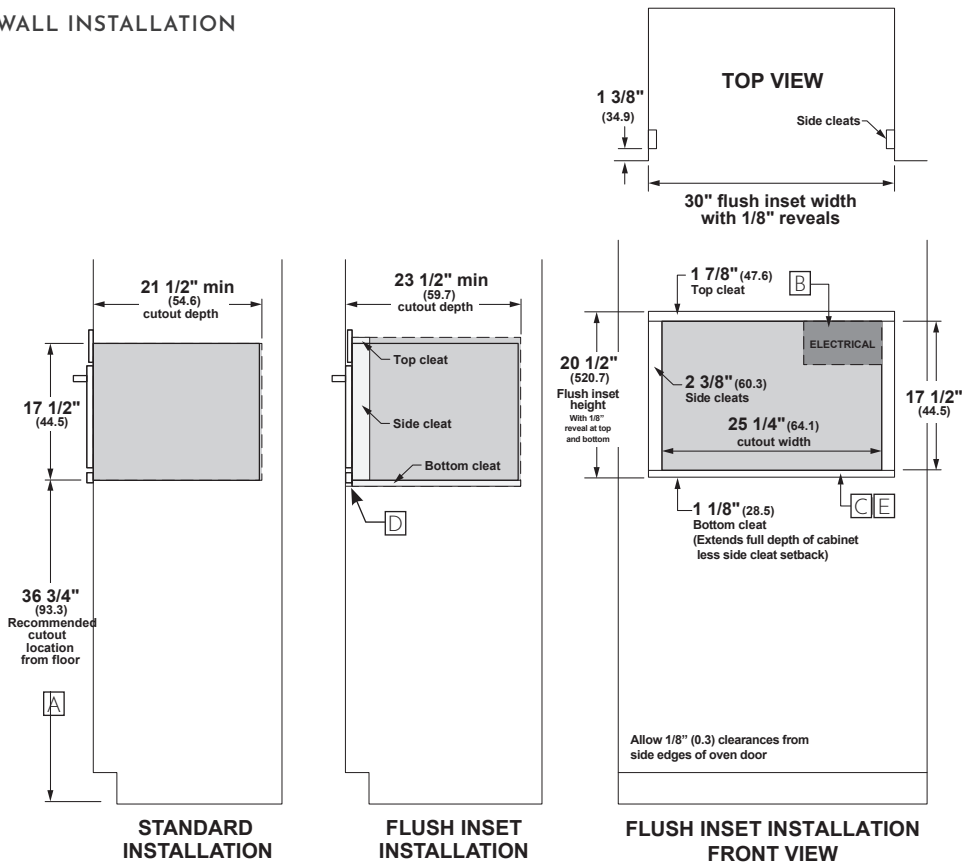

## HELPFUL TIPS

- A Based on a user height of 5' 6" to 5' 10"
- B Junction box location (May also be located in adjacent cabinet.)
- C Platform must be able to support 130 lbs (59 kg)
- D Top surface of cabinet must be an appearance finished surface for flush installation.
- E Cleats may be visible and should be finished to match cabinetry.
- F Maximum toe kick height of 4" when installed beneath a certified cooktop.

## UNDERCOUNTER INSTALLATION

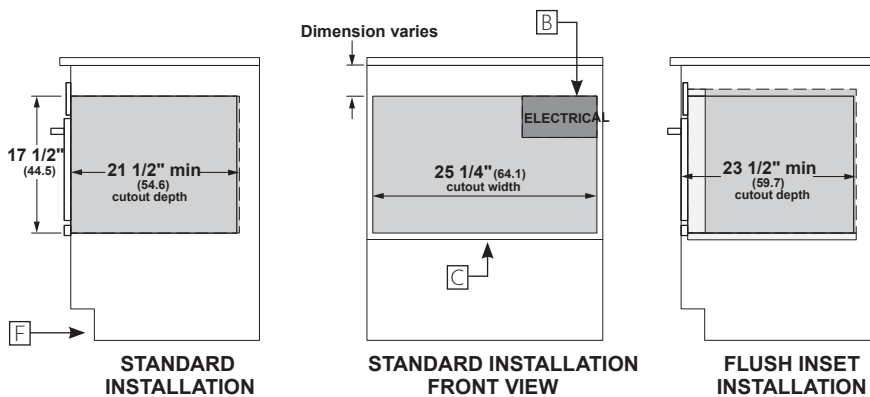

For more details, refer to the installation instructions for this product on Monogram.com. Dimensions in parentheses are in centimeters unless otherwise noted.