

MONOGRAM 30" BUILT-IN ADVANTIUM® 240 ZSB9231NSS

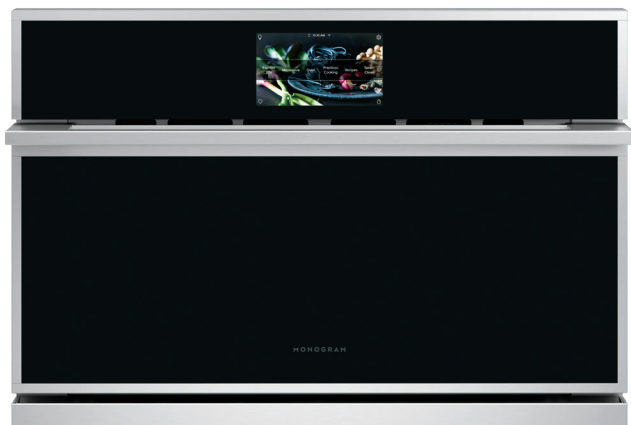

THE MONOGRAM MINIMALIST COLLECTION

Streamlined design and precisely machined metals create a contemporary yet functional aesthetic

5-IN-1-OVEN

Experience exceptional flexibility and cooking results with this innovative five-in-one oven. Advantium® Technology enhanced, it can be used as a convection oven, toaster oven, warming/proofing oven, precision cook oven, and microwave

POWERFUL PERFORMANCE

Oven-quality foods cook up to eight times faster than a conventional oven, with no preheating required

SPEEDCOOK TECHNOLOGY

Offering the ultimate in cooking speed and flexibility, the halogen-lighting system combines with microwave technology to Speedcook favorite foods to perfection in minutes, with no preheating

SPACIOUS INTERIOR

Generous, 1.7-cu.-ft oven space with a large 16" turntable allows for full rotation of a 9" x 13" casserole dish; plus the removable oven rack offers the convenience of multi-level cooking

PREPROGRAMMED RECIPES

Provide quick and easy programming of over 175 pre-set food selections and allows programming of up to 30 custom recipes

INSTALLATION FLEXIBILITY

Ovens can be installed in 30" wall cabinet and can also be installed undercounter

LCD CONTROLS

Allow you to adjust oven settings with little effort

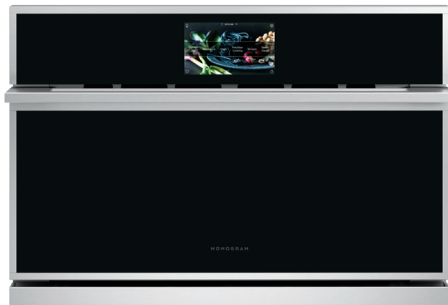

SPECIFICATIONS

| | |
|--------------------------------------|---|
| Overall Width | 29 3/4" (75.6) |
| Overall Height | 20 1/4" (51.4) |
| Overall Depth | 23" (58.4) |
| Oven Door Clearance | 13 1/4" (33.7) |
| Overall Oven Interior Capacity | 1.7 cu. ft. |
| Oven Interior Dimensions (W x H x D) | 20 1/16" x 8 1/2" x 17" (51 cm x 21.6 cm x 43.2 cm) |
| Minimum Cabinet Width | 30" (76.2) |
| Minimum Cabinet Depth | 21 1/2" (54.6) |
| Minimum Base Support | 130 lbs (59 kg) |
| Cutout Width | 25 1/4" (64.1) |
| Cutout Height | 17 1/2" (44.5) |
| Cutout Depth | 21 1/2" (54.6) Min |
| Volt/Hertz/Amps | 240/208 VAC, 60 Hz, 30A |
| Conduit Length | 48 1/2" (123.2) |
| Electrical Rating | 4.72 kW at 208V 6.3 kW at 240V |
| Total Amps | 30" (76.2) |
| Shipping Weight | 87 lbs (39.5 kg) |

ATTENTION ELECTRICIAN:

A 240/208V, 60Hz, 30 Amp circuit is required. An individual properly grounded branch circuit or circuit breaker is required. Hardware junction box is required for built-in product.

OVERALL DIMENSIONS

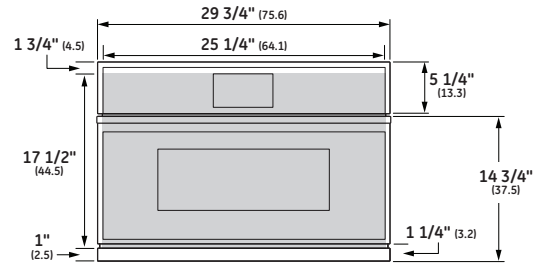

FRONT VIEW (SHOWING CUTOUT OVERLAP)

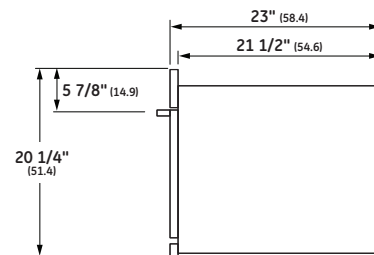

SIDE VIEW

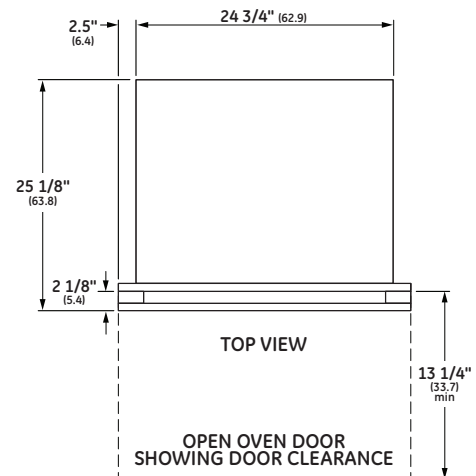

TOP VIEW

OPEN OVEN DOOR
SHOWING DOOR CLEARANCE

Dimensions in parentheses are in centimeters unless otherwise noted. Actual product dimensions may vary due to manufacturing tolerances.

WALL INSTALLATION

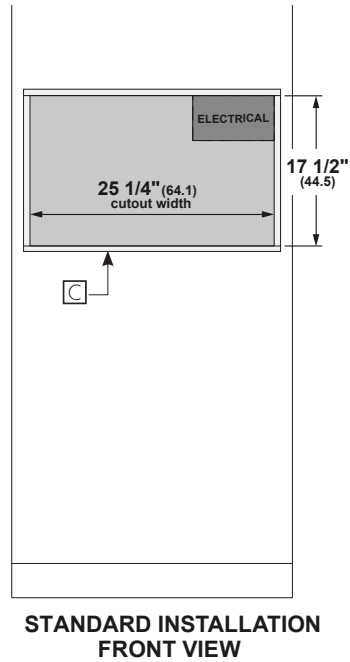
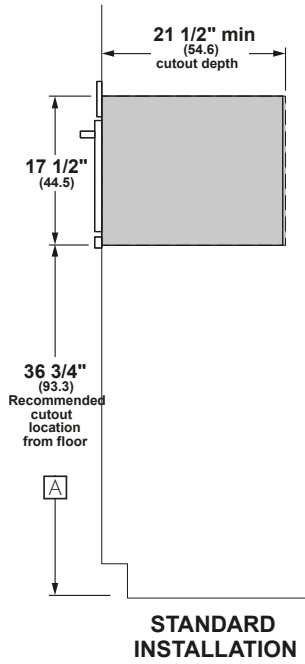

HELPFUL TIPS

- A** Based on a user height of 5' 6" to 5' 10"
- B** Junction box location (May also be located in adjacent cabinet.)
- C** Platform must be able to support 130 lbs (59 kg)

For more details, refer to the installation instructions for this product on Monogram.com. Dimensions in parentheses are in centimeters unless otherwise noted.