

# REF18WCPIXL

## 18" BUILT-IN WINE CELLAR COLUMN STAINLESS STEEL LEFT SWING DOOR



Preserve the character of your favorite wine and champagne as a result of zone dedicated evaporators, cork protecting humidity controls, UV light-shielding glass window and vibration-free variable speed compressor.

Enjoy ample and flexible storage of all type of bottles thanks to Bertazzoni's columns design featuring the most usable interior depth in the category.

Ensure the utmost in bottle storage with a precious wood shelf design anchored by a premium telescopic smooth motion glide system.

Access temperature, humidity and interior lighting settings for each zone through the intuitive digital touch-control interface.

Maintain the correct temperature in each zone when opening the door for reloading, thanks to the unique lateral side-to-side airflow circulation.

Create a truly flush front alignment with the adjacent cabinets and minimal clearance with the exclusive "lift & swing" door hinge.

Customize virtually any column combination suited for your kitchen layout. Single, double, triple and more configurations are possible.

Create a harmonized look throughout the kitchen selecting the handle style that matches your complete Bertazzoni appliances suite. Panel ready models provide the option to mount your own cabinet hardware.

Designed and manufactured with pride in Italy.

Have peace of mind with a standard full 2 years parts & labor warranty and 5 years warranty for the entire sealed system.

### PRODUCT FEATURES

Size	H: 84" W: 18" D: 24 3/8"
Refrigerator type	Built-in wine cellar column
Door finish	Stainless steel with glass
Interior finish	White aluminum
User interface	Digital touch control interface inside
Lighting	LED lights interior illumination
Wine racks	12 wooden wine racks
Cooling system	Two temperature zones
Modes	Humidity control, Sabbath mode
Open door alarm	Yes

### INTERIOR CAPACITY

Bottle capacity	52 bottles
-----------------	------------

### TECHNICAL SPECIFICATIONS

Electrical supply	115 V 60 HZ - 152 W 1.4 Amp
Power connection	NEMA 5-15P with 79" power cord
Energy consumption	390.0 kWh/yr
Certification	cUL
Warranty	2 years parts & labor Sealed system: 5 years labor
Packaging dimensions and weight	W 25 9/16" H 89" D 31 2/16" 324.08 lbs

### OPTIONAL ACCESSORIES

901560	42" Bridge toekick
901561	48" Bridge toekick
HERHKCOL	Handle kit for columns Heritage
MASHKCOL	Handle kit for columns Master
PROHKCOL	Handle kit for columns Professional

# REF18WCPIXL

18" BUILT-IN WINE CELLAR COLUMN  
STAINLESS STEEL LEFT SWING DOOR



## PRODUCT DIMENSIONS

SIDE VIEW

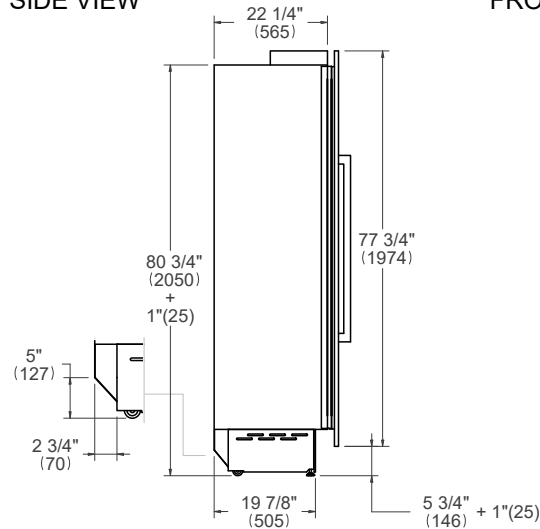

FRONT VIEW

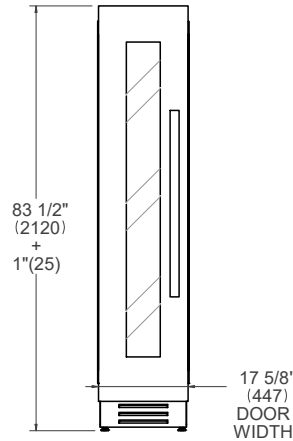

TOP VIEW

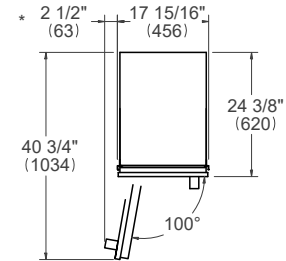

\* Maximum Overall Handle Dimension

## ELECTRICAL CONNECTION

TOP VIEW

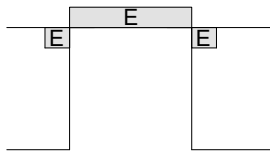

FRONT VIEW

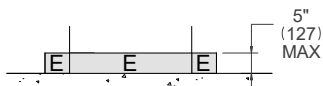

**E** A properly-grounded, horizontally-mounted electrical receptacle should be installed according to this drawing.

Connection(s) placement within the opening may require additional cabinet depth.

## INSTALLATION REQUIREMENTS

If the appliance(s) is not connected through the side profile trims to secured cabinetry anti-tip brackets must be installed.

## CUTOUT DIMENSIONS

TOP VIEW

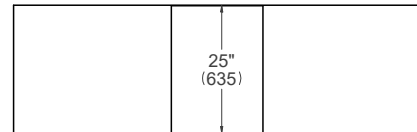

SIDE VIEW

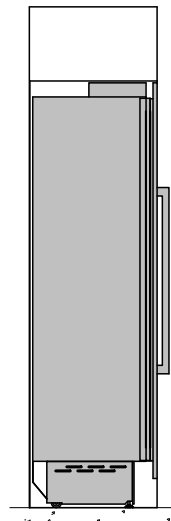

FRONT VIEW

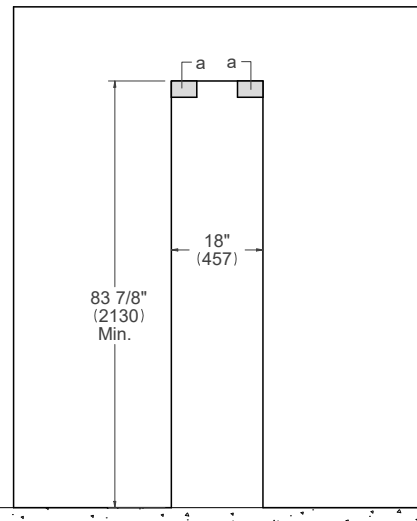

(a) Area to be left clear for the anti-tipping brackets – 3 1/2x5" (82x127mm)

For installation of multiple products in combination, refer to the Built-in Food Preservation Design Guide at [us.bertazzoni.com](http://us.bertazzoni.com) or [ca.bertazzoni.com](http://ca.bertazzoni.com)

**Disclaimer:** while every effort has been made to ensure the accuracy of the information contained in this document, Fratelli Bertazzoni reserves the right to change it at any time without notice. For detailed installation instructions, consult the installation manual. Fratelli Bertazzoni, Bertazzoni and the winged wheel brand icon are registered trademarks of Bertazzoni Spa.