



Read and Save These Instructions
All Hoods Must Be Installed By A Qualified Installer

INSTALLATION INSTRUCTIONS

ISLAND LINER INSERT

Read All Instructions Thoroughly Before Beginning Installation

WARNING - TO REDUCE THE RISK OF FIRE, ELECTRIC SHOCK, OR INJURY TO PERSONS, OBSERVE THE FOLLOWING:

- A. Installation work and electrical wiring must be done by qualified person(s) in accordance with all applicable codes and standards, including fire-rated construction. Switch power off at service panel and lock the service disconnecting means to prevent power from being switched on accidentally during installation.**
- B. When cutting or drilling into wall or ceiling, do not damage electrical wiring and other hidden utilities.**
- C. Ducted fans must always be vented to the outdoors.**
- D. Sufficient air is needed for proper combustion and exhausting of gases through the flue (chimney) of fuel burning equipment to prevent back drafting. Follow the heating equipment manufacturer's guideline and safety standards such as those published by the National Fire Protection Association (NFPA), and the American Society for Heating, Refrigeration and Air Conditioning Engineers (ASHRAE), and local code authorities.**
- E. ASHRAE residential ventilation standard 62.2 limits exhaust fans (total) to a maximum of 15 CFM per 100 square feet of occupiable space, unless a back drafting test is performed or make-up air is provided. Consult a local HVAC engineer for make-up air evaluation.**

WARNING - TO REDUCE THE RISK OF FIRE, USE ONLY METAL DUCTWORK

Vent-A-Hood®

Ducting Do's and Don'ts

NEVER restrict the duct size. The island dual blower unit (T200) requires 8" round duct or equivalent (50 square inches). The island cluster blower unit (T400) requires 12" round or equivalent (113 square inches). When combining ducts together, the square inch area must reflect the total square inch area of the ducts being combined. Using the included Vent-A-Hood transition(s) will ensure proper efficiency.

Blower	Duct Size	Sq. Inch Area	Vent-A-Hood Transition
Island Dual (T200)	8" round or equivalent	50"	VP565 (Included)
Island Cluster Blower (T400)	12" round or equivalent	113"	VP564 (Included)

Do not use flexible or corrugated duct. This type of duct will restrict airflow and reduce performance. Only use smooth, galvanized, metal duct. Observe local codes regarding special duct requirements and placement of duct against combustibles. Make the duct run as short and as straight as possible with as few turns as possible. Avoid sharp-angled turns. Instead, use smooth, gradual turns such as adjustable elbows or 45 degree angled turns. For duct runs over 20 feet, increase the duct diameter by one inch for every ten feet of duct. A 90 degree elbow is equal to 5 feet of duct. Using Vent-A-Hood roof jacks or wall louvers (back page) will ensure proper efficiency. Airflow must not be restricted at the end of the duct run. Do not use screen wire or spring-loaded doors on wall louvers or roof jacks. Do not terminate venting into an attic or chimney. Where possible, seal joints with duct tape. The hood must be ducted to the outdoors without restrictions.

YES



Smooth Duct

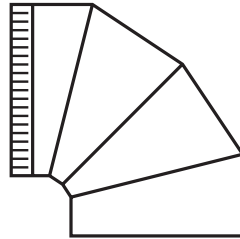

Smooth Gradual Turn

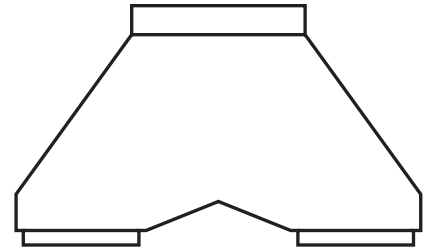

Proper Combining of Two Ducts

NO

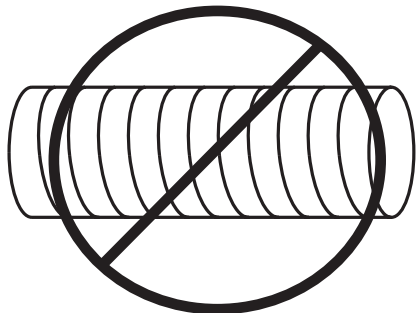

Flexible Duct

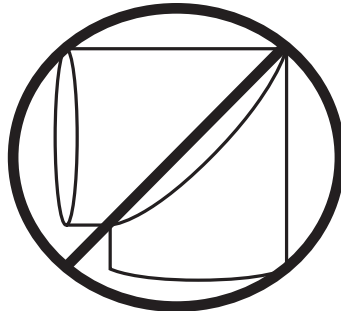

Sharp Angled Turns

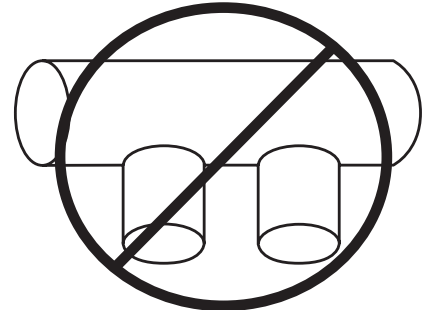

Improper Combining of Two Ducts

Vent-A-Hood®

Installation Details

- 1) Read all instructions thoroughly before beginning installation. Note: These instructions apply to standard hoods only. Custom hoods may require additional specification consideration.
- 2) When installing the TSLE/TPSLE island liner, it is recommended that the bottom edge of the liner be located no more than 30" from the cooking surface. For custom liners, the recommended height off the cooking surface is dependent on the depth of the liner. In general, the deeper the custom liner, the higher off the cooking surface it can be, up to a maximum recommended height of 30". Exceeding recommended mounting height may compromise performance.

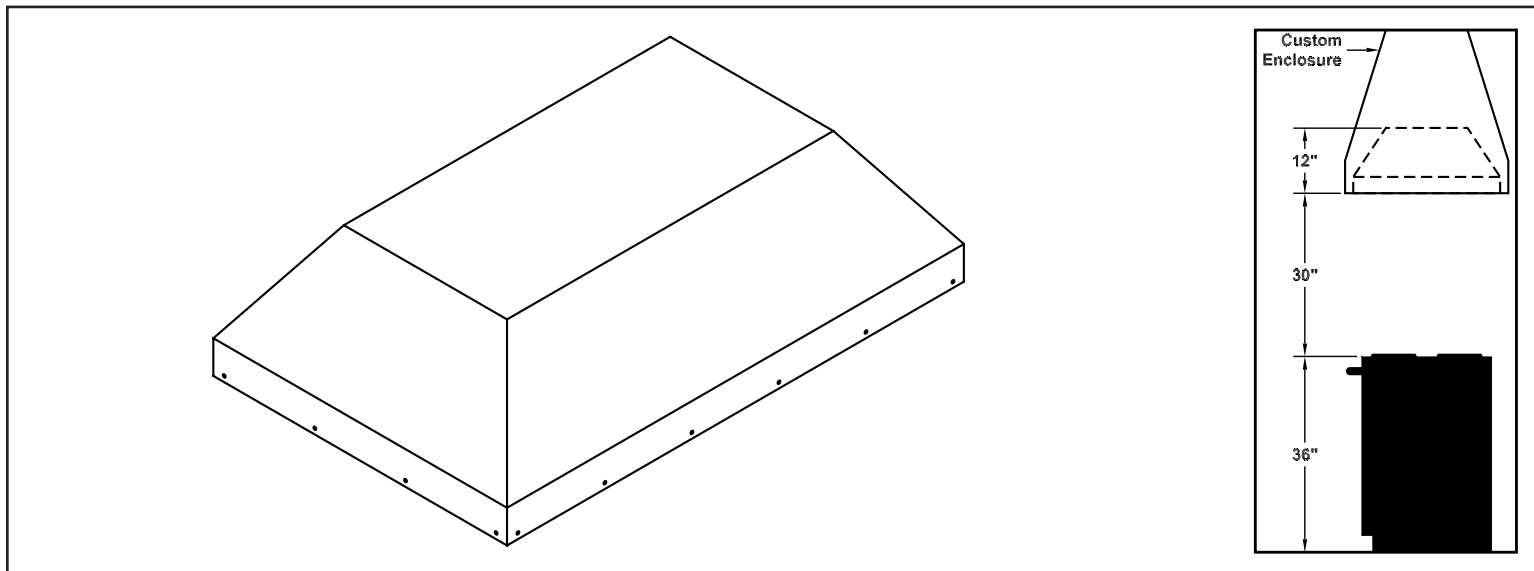

- 3) Install the duct from the outside of the home down to the location of the exhaust outlet on the top of the transition plus 1". This will allow the transition to engage 1" inside the duct. Consult the connection diagrams (on next page) for further details on exhaust outlet placement.

Use duct tape to seal all joints. A complete listing of available Vent-A-Hood ducting materials is included on the back page of this instruction sheet.

Transition heights are as follows:

Island Dual Blower (T200): 8" round duct connects to 9" tall VP565 transition (included).

Island Cluster Blower (T400): 12" round duct connects to 11 1/4" tall VP564 transition (included).

- 4) Remove the liner from its packaging and place it on the floor or countertop for access to the inside of the liner. Remove, open, and save the liner trim kit from the packaging. The liner trim kit will be used later in Step 10.
- 5) Remove the blower shields (A) by loosening the two brass screws on the bottom of the shield. Gently close the back draft dampers from the top side of the hood. To remove the blower housings, unsnap the suitcase latches (B) (one on each side of the housing). The housings should be pulled forward and gently "tipped" to clear the blower wheels and then out of the hood.

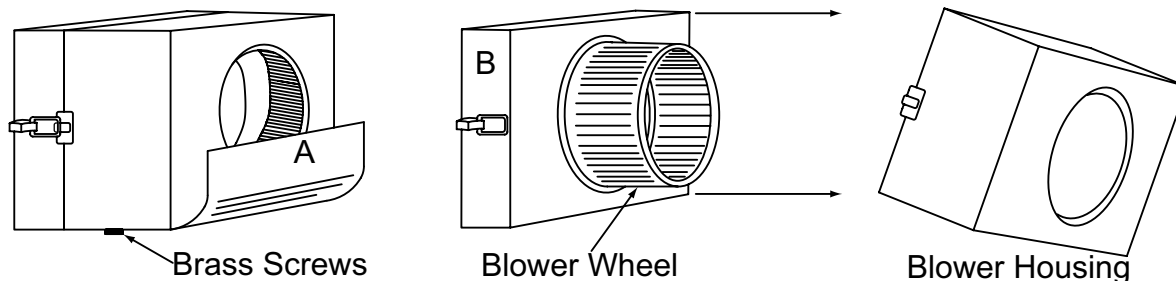

Vent-A-Hood®

Installation Details Continued

- 6) Remove the three screws retaining the blower motor(s). Unplug and remove the motor(s), taking care not to damage the blower wheel(s). It is not necessary to remove the blower wheel from the motor.

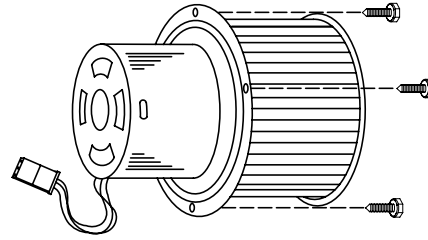

TSLE Connection Diagram (36" - 48" Widths)

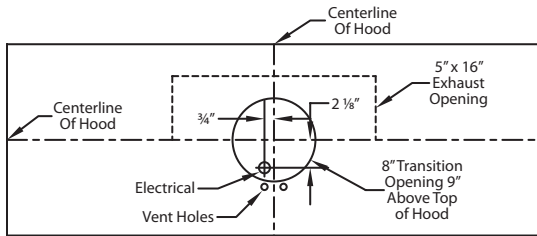

**550 CFM T200 Dual Blower
(Top View)**

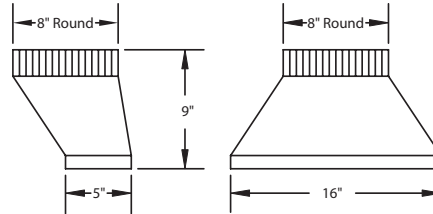

**VP565 Transition
(Included)**

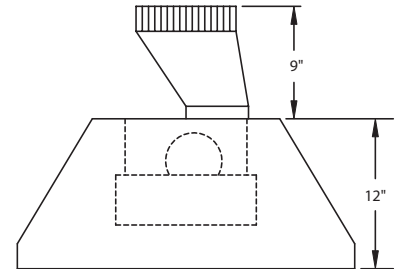

**Transition Installed
(Side View)**

TPSLE Connection Diagram (48" - 66" Widths)

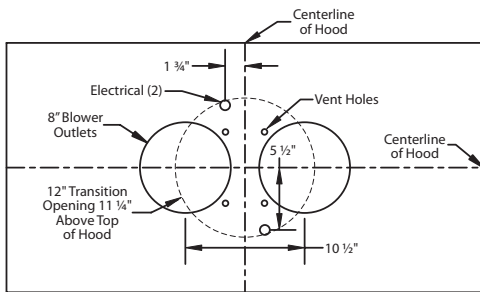

**1100 CFM T400 Cluster Blower
(Top View)**

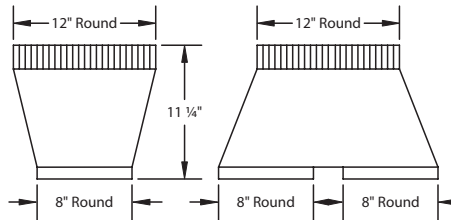

**VP564 Transition
(Included)**

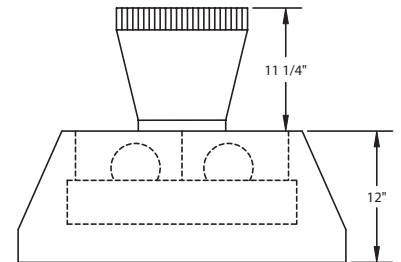

**Transition Installed
(Side View)**

Warning: Make sure power is off and locked at the service disconnecting means on the service panel during installation.

- 7) Install an appropriate 1/2" UL listed electrical wire clamp through each motor box electrical opening on the top of the liner. Install electrical wiring from the service panel to the liner location for each motor box. Consult the connection diagrams (above) for further details on electrical placement.

Model	Volts	Amps*	Hz	RPM	CFM SP@0.0"	Equivalent CFM*	CFM SP@0.1"	CFM SP@0.2"	CFM SP@0.3"	Minimum Round Duct Size	Sones#
T200 Island Dual	115	2.9	60	1550	550	900	507	471	431	8" (50 in. ²)	6.0
T400 Island Cluster	115	5.8	60	1550	1100	1800	998	855	774	12" (13 in. ²)	6.4

* Add 0.5 amp for each halogen light.
 # Because the Magic Lung® blower uses centrifugal filtration rather than conventional baffle or mesh filters, the Magic Lung® blower can handle cooking equipment with higher cubic feet per minute (CFM) requirements and can deliver equivalent CFM much more efficiently than other than other filtration systems. When comparing the Magic Lung® with other blower units made by other manufacturers, use the "Equivalent CFM".
 # Ratings in accordance with the Standard Test Code by the Energy Systems Laboratory of the Texas Engineering Experiment Station.

- 8) Extend wires to the liner and insert them into the electrical wire clamp on each motor box. Tighten the wire clamp(s). From inside the liner, using UL listed wire nuts, attach the "neutral" wire(s) to the white lead(s), the "hot" wire(s) to the black lead(s), and the ground wire(s) to the green lead(s) inside the motor box(es).

Warning: Do not operate hood without proper ground connection.

Vent-A-Hood®

Installation Details Continued

- 9) Install transition in the exhaust collar(s). Seal connection with duct tape. Note: The transition must engage inside the exhaust collar. While aligning the duct connection and guiding the wires, lift the liner up into the enclosure flushing the bottom edges of the liner and the enclosure. Duct and transition should connect together as the liner is raised into place. Wood strips may be necessary to fill any gaps between the opening and the liner if the opening in the wood surround is larger than the liner.
- 10) Install a wood screw with a countersunk washer and a flat washer into each mounting hole along the bottom edge of the liner. Note: The hardware used in this step can be found in the liner trim kit that was previously removed from the packaging in Step 4.
- 11) Install the trim piece for the back and front of the liner (provided in the liner trim kit) by hooking one side under the bottom edges of the back countersunk washers. Snap the trim piece over the top of the countersunk washers by applying pressure upward and toward the liner wall. Repeat this process for the side trim pieces (provided in the liner trim kit). Note: It may be necessary to lightly tap the trim piece with a rubber mallet.
- 12) Plug the motors into the liner and reinstall the blower motor retaining screws that were previously removed in Step 6. Note: The side of the motor box where the “black” motors mount is labeled to ensure the motors are installed back into the hood in the proper position.
- 13) Replace the blower housings and the blower shields. Make sure that the dampers open and close smoothly.
- 14) Refer to the Owner Maintenance Guide Operating Instructions for proper hood operation. Test all blower and light functions to ensure they are operating properly.

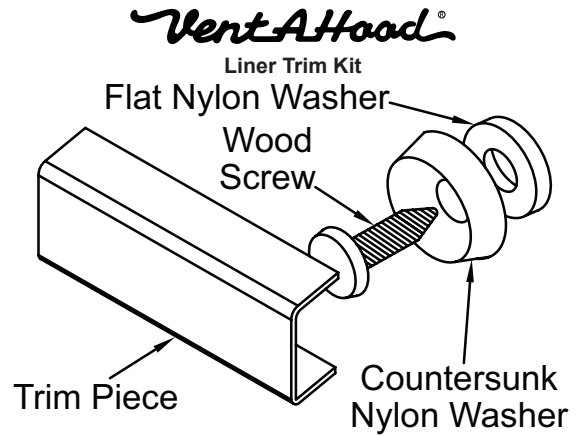

VENTING

Vent-A-Hood®

ACCESSORIES

WALL LOUVER

MODEL	DIM
VP526	6" Round
VP527	7" Round
VP528	8" Round

WALL LOUVER

MODEL	DIM
VP554	10" Round

WALL LOUVER

MODEL	DIM
VP555	12" Round

RECTANGULAR WALL LOUVER

MODEL	DIM
VP538	6" x 8 1/2"
VP560	3 1/4" x 10"

LOW PROFILE ROOF JACK (MAXIMUM 4/12 PITCH)

MODEL	DIM
VP539	6" Round
VP540	7" Round
VP541	8" Round

LOW PROFILE ROOF JACK (MAXIMUM 4/12 PITCH)

MODEL	DIM
VP552	10" Round
VP553	12" Round

LOW PROFILE ROOF JACK (MINIMUM 4/12 PITCH)

MODEL	DIM
VP539-HP	6" Round
VP540-HP	7" Round
VP541-HP	8" Round

LOW PROFILE ROOF JACK (MINIMUM 4/12 PITCH)

MODEL	DIM
VP552-HP	10" Round
VP553-HP	12" Round

BACK/SIDE VENT ELBOW

MODEL	DIM
VP561	8" to 6" x 8 1/2"

ADJUSTABLE ELBOW

VP513 - 8 1/2"
VP514 - 9 9/16"
VP515 - 10 5/8"

MODEL	DIM
VP513	6" Round
VP514	7" Round
VP515	8" Round

MULTI-BLOWER TRANSITION

VP562 - 17 1/2"
VP563 - 16 1/2"

MODEL	DIM
VP562	6" & 8" to 10"
VP563	8" & 8" to 12"

3 1/4" x 10" TO 7" TRANSITION

MODEL	DIM
VP521	3 1/4" x 10" to 7"

OFFSET KIT - ROUND

MODEL	DIM
VP529	6" Rnd to 7" Rnd

OFFSET KIT - RECTANGULAR

MODEL	DIM
VP550	6" Rnd to 3 1/4" x 10"

STANDARD ISLAND TRANSITION

MODEL	DIM
VP565	5" x 16" to 8" Rnd

CLUSTER BLOWER TRANSITION

MODEL	DIM
VP564	8" & 8" to 12"

OFFSET L & R TRANSITION FOR ISLAND BLOWERS

MODEL	DIM
VP542	Top Left
VP543	Top Right

SIDE VENT TRANSITION L & R FOR ISLAND BLOWERS

MODEL	DIM
VP544	Side Left
VP545	Side Right

"Y" TRANSITION

MODEL	DIM
VP517	8" & 8" to 12"
VP518	6" & 8" to 12"
VP551	6" & 8" to 10"

WALL COLLARS

MODEL	DIM
VP533	6" Round
VP535	8" Round
VP537	6" x 8 1/2"

3 1/4" x 10" BACK VENT ELBOW

MODEL	DIM
VP559	3 1/4" x 10"

ROUND DUCT PIPE

MODEL	DIM
VP500	6" Round
VP501	7" Round
VP502	8" Round

3 1/4" RECTANGULAR DUCT PIPE

MODEL	DIM
VP504	3 1/4" x 10"
VP505	3 1/4" x 12"
VP506	3 1/4" x 16"

6" RECTANGULAR DUCT PIPE

MODEL	DIM
VP507	6" x 8 1/2"